

# MATRIX<sup>®</sup> PRO GS

## USER MANUAL

Software version 4.21

**MATRIX<sup>®</sup> PRO 840GS**



**MATRIX<sup>®</sup> PRO 570GS**

**TeeJet<sup>®</sup>**  
TECHNOLOGIES

A Subsidiary of  Spraying Systems Co.<sup>®</sup>

# GETTING STARTED

## #1 Turn Power On





Press the POWER button  to power on the console.

## #2 Home Screen

Once the power up sequence has completed, the Home screen will appear with the option to start a new job or continue an existing job.

## #3 Go to Unit Setup

1. Press UNIT SETUP bottom tab .

The Configuration  options will be displayed first. Data management , Console settings  and Tools  can be accessed through the side tab keys.

### Cultural Setup

1. Press CONSOLE side tab .
2. Press **Cultural**.

Culture is used to configure units, language and time zone settings.

### GNSS Setup

1. Press CONFIGURATION side tab .
2. Press **GNSS Receiver Configuration**.

GNSS is used to configure GNSS type, GNSS port and PRN as well as to view GNSS status information.

### Implement Setup

1. Press CONFIGURATION side tab .
2. Press **Implement**.





Implement setup is used to establish the various settings associated with straight mode, spreader mode or staggered mode. Settings will vary depending on if an AutoSteer or BoomPilot system is present.

### AutoSteer Setup

1. Press CONFIGURATION side tab .
2. Press **AutoSteer**.

When a Steering Control Module (SCM or SCM Pro) is present, assisted/auto steering options will be available. For detailed setup instructions, refer to your specific AutoSteer installation manual.

## #4 Go to Guidance Screen

1. Press VEHICLE VIEW GUIDANCE tab , FIELD VIEW GUIDANCE tab  or REALVIEW GUIDANCE tab .
2. Press NAVIGATION AND GUIDANCE OPTIONS tab  to display navigation options.

### Choose a guidance mode

- ▶ Straight AB 
- ▶ Curved AB 
- ▶ Circle Pivot 
- ▶ Last Pass 
- ▶ NextRow 

### Mark A and B Points

To establish a AB guideline.

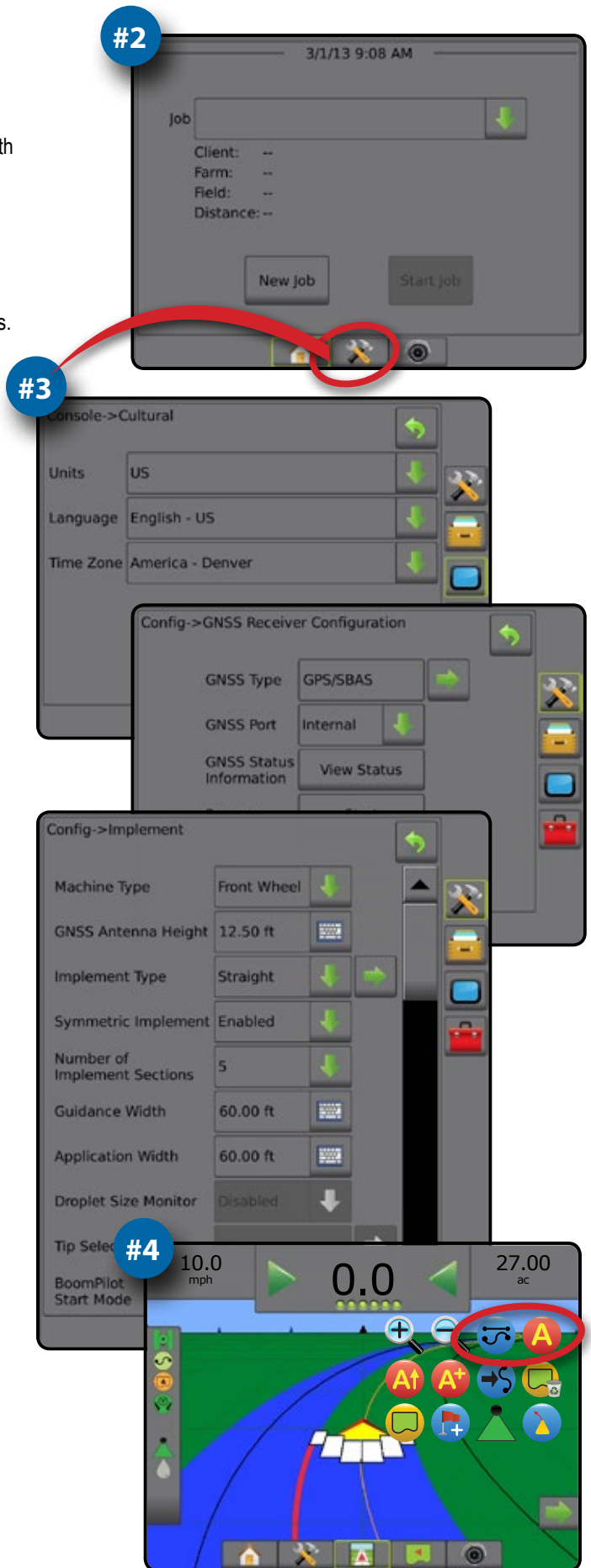

## Table of Contents

<b>CHAPTER 1 – INTRODUCTION</b>	<b>1</b>
Product Upgrades Available .....	1
<b>SYSTEM COMPONENTS</b>	<b>1</b>
Matrix Pro 570GS Console .....	1
Matrix Pro 840GS Console .....	2
Buttons .....	2
Additional Information .....	2
RealView® Camera .....	3
<b>CONFIGURATIONS</b>	<b>3</b>
<b>BASIC SCREEN USE</b>	<b>3</b>
Bottom Tab Keys .....	3
Unavailable Options When Job is Active .....	3
Console Screen Colors .....	4
Simple or Advanced Mode .....	4
Warnings and Information Pop-ups .....	5
Setup Option Information .....	5
Drop Down Menu Selections .....	5
Scrolling Screens .....	5
Keyboard Entry Screen .....	6
Next Page .....	6
Checkboxes .....	6
<b>CHAPTER 2 – JOBS / HOME SCREEN</b>	<b>7</b>
Simple Mode .....	7
Advanced Mode .....	7
<b>SIMPLE MODE</b>	<b>8</b>
New Job .....	8
Continue Job .....	8
Close Job .....	8
<b>ADVANCED MODE</b>	<b>8</b>
New Job .....	8
Start Job .....	8
<i>Distance</i> .....	8
Close Job .....	8
<b>CHAPTER 3 – FULL SCREEN VIDEO VIEW</b>	<b>9</b>
Camera Snapshot .....	10
VSM Camera Options .....	10
<b>CHAPTER 4 – SYSTEM SETUP</b>	<b>11</b>
<b>OVERVIEW</b>	<b>11</b>



## CONFIGURATION

12

- Implement..... 13
  - Implement Type* ..... 13
  - Single Section Setup ..... 13
  - Multiple Sections with SDM/SFM Setup ..... 14
  - Droplet Size Monitor ..... 15
  - Tip Selection ..... 16
  - Reverse Sense Module ..... 16
- Guidance [Lightbar]..... 17
- AutoSteer..... 18
  - Assisted/Auto Steering Unavailable*..... 18
  - FieldPilot [using a SCM] ..... 18
  - FieldPilot Pro / UniPilot Pro [using a SCM Pro] ..... 18
  - Active Vehicle*..... 19
- Tilt Correction ..... 20
  - Field Level Unavailable*..... 20
  - Tilt Correction Unavailable* ..... 20
- GNSS Receiver Configuration..... 20
  - PRN Not Shown*..... 20
- Video ..... 21
  - Video Setup Unavailable*..... 21
- Sensors ..... 21
  - Sensors Unavailable* ..... 22
  - Input/Output Module Pressure Sensor ..... 22
  - Droplet Size Monitor* ..... 22



## DATA MANAGEMENT

23

- Job Data ..... 23
  - Job Data Unavailable*..... 23
  - Transfer ..... 24
  - Manage ..... 24
- Reports ..... 25
- Options (Job Mode) ..... 25
- Machine Settings ..... 26
  - Transfer ..... 27
  - Manage ..... 27



## CONSOLE

28

- About ..... 28
- Display ..... 29
- Cultural ..... 29
- Audio Volume ..... 30
- Demo GNSS ..... 30
  - Restart Demo GNSS ..... 31
- Feature Unlock..... 31



## TOOLS

32

- Upload Software ..... 32
- Extras..... 33



## CHAPTER 5 – GNSS RECEIVER CONFIGURATION

34

GNSS Receiver Configuration.....	34
GNSS Type .....	35
GNSS Port.....	35
<i>External Receiver Minimum Configuration Requirements</i> .....	35
GNSS Status Information .....	36
<i>GNSS Status Information on Guidance Screens</i> .....	36
<i>GGA Requirements</i> .....	36
Program .....	37
PRN .....	37
<i>Alternate PRN</i> .....	37
<i>PRN Not Shown</i> .....	37
GNSS Glossary.....	38

## CHAPTER 6 – IMPLEMENT SETUP

39

### IMPLEMENT TYPE

39

Section Numbers.....	39
Straight.....	40
Single Section .....	40
Multiple Sections.....	40
Spreader – TeeJet.....	41
Single Section .....	41
Multiple Sections.....	42
Spreader – OEM.....	44
Single Section .....	44
Multiple Sections.....	44
Staggered.....	45
Multiple Sections.....	45

### APPLICATION OR WORKING WIDTH

47

Single Section.....	47
Multiple Sections.....	47

### LATERAL IMPLEMENT OFFSET DISTANCE ADJUSTMENT

48

GNSS Offset Adjustment Calculation.....	48
Lateral Implement Offset Adjustment.....	49

### REVERSE SENSE MODULE

50

Reverse on Guidance Screens .....	50
<i>Availability with Assisted/Automatic Steering</i> .....	50

### TIP SELECTION

51

Preset .....	51
Current Tip.....	52

### DROPLET SIZE MONITOR

52

Setup.....	52
Enable/Disable DSM .....	52
Tip Selection / Current Tip.....	53
Input/Output Module Pressure Sensor.....	53

# Matrix® Pro 570GS • Matrix® Pro 840GS

INTRODUCTION  
 HOME  
 FULL SCREEN  
 SETUP  
 GNSS  
 IMPLEMENT  
 GUIDANCE  
 RATE CONTROL  
 APPENDIX

Operation .....	53
Status Bar .....	53
<i>Droplet Size Chart</i> .....	53
Guidance Bar .....	53

## BOOMPILOT 54

BoomPilot Start Mode .....	54
BoomPilot Icon .....	55

## CHAPTER 7 – GUIDANCE 56

Navigation Screens Options .....	57
----------------------------------	----

## GUIDANCE BAR 58

Navigation Activity & Boom Status .....	58
<i>Cross Track Error</i> .....	58
Selectable Information.....	59

## STATUS BAR 59

Status/Information Screens .....	60
----------------------------------	----

## NAVIGATION SCREENS 62

Vehicle View .....	63
Field View.....	64
RealView Guidance .....	65

## GUIDANCE MODES 66

Straight AB Guidance .....	66
Curved AB Guidance .....	66
Circle Pivot Guidance .....	66
Last Pass Guidance.....	66
NextRow Guidance .....	66
No Guidance.....	66





## GUIDELINES 67

Curved Lookahead Guideline .....	67
Marking A and B Points .....	67
A+ Nudge Feature.....	68
Next Guideline Feature.....	69
Last Pass Guidelines.....	69
NextRow Guidelines .....	70
Azimuth Degree.....	70

## APPLICATION BOUNDARY 71

## RETURN TO POINT 73

Marking a Return Point.....	73
Delete the Return Point .....	73
Guidance to a Return Point .....	73

	<b>BOOMPILOT</b>	<b>74</b>
	No Section Control Module .....	74
	Console Only .....	74
	With Optional Work On/Off Switch .....	74
	<i>Using the Console</i> .....	74
	With TeeJet Section Control Module and Switchbox or ISM.....	75
	With TeeJet Section Control Module .....	75
	<b>ZOOM IN/OUT</b>	<b>75</b>
	Vehicle View.....	75
	Field View.....	75
	<b>PAN MODE</b>	<b>76</b>
	<b>APPLICATION MAPPING</b>	<b>76</b>
	<b>REALVIEW SPECIFIC OPTIONS</b>	<b>77</b>
	RealView Guidance Options .....	78
	Camera Snapshot .....	78
	VSM Camera Options .....	78
<b>CHAPTER 8 – THIRD-PARTY RATE CONTROL</b>		<b>80</b>
	<b>THIRD-PARTY RATE CONTROL UNLOCK</b>	<b>80</b>
	<b>SETUP OPTIONS</b>	<b>81</b>
	Third-Party Rate Control .....	81
	Product .....	81
	<b>GUIDANCE SCREEN OPTIONS</b>	<b>82</b>
	Guidance Bar .....	82
	Status Bar .....	82
	Application Mapping .....	82
	<i>Duplicating and Transferring Maps</i> .....	83
	Coverage Map.....	83
	<i>On Screen Mapping</i> .....	83
	Prescription Map .....	83
	<i>On Screen Mapping</i> .....	83
	Application Map .....	84
	<i>On Screen Mapping</i> .....	84
	<i>Color Range Selection</i> .....	84
	Target Rate Map.....	85
	<i>On Screen Mapping</i> .....	85
	<i>Target Rates</i> .....	85

# Matrix® Pro 570GS • Matrix® Pro 840GS

INTRODUCTION	<b>APPENDIX A – SYSTEM CONFIGURATIONS</b>	<b>86</b>
	<b>APPENDIX B – MATRIX PRO GS CONSOLE MENU SETTINGS</b>	<b>88</b>
	<b>APPENDIX C – UNIT SPECIFICATIONS</b>	<b>91</b>
HOME	<b>APPENDIX D – SETTING RANGES</b>	<b>92</b>
	<b>APPENDIX E – UTM COORDINATES AND ZONES</b>	<b>92</b>
FULL SCREEN		
SETUP		
GNSS		
IMPLEMENT		
GUIDANCE		
RATE CONTROL		
APPENDIX		



## CHAPTER 1 – INTRODUCTION

The Matrix Pro GS allows the management of multiple connected modules plus GNSS mapping, Guidance, FieldPilot®, BoomPilot®, Rate Control, and data collection in a single console using CAN bus technology. This replaces multiple consoles in the cab with one robust system.

### Product Upgrades Available

- FieldPilot® or FieldPilot® Pro auto steering
- UniPilot® or UniPilot® Pro assisted steering
- BoomPilot® automated boom section control
- Tilt Gyro Module
- Video Selection Modules for up to 8 cameras
- External GNSS receiver or antenna upgrades
- Fieldware® Link enhanced data organization application
- Pressure Sensor Interface Kit for Droplet Size Monitor
- Third Party Rate Control

## SYSTEM COMPONENTS

### Matrix Pro 570GS Console

The Matrix Pro 570GS is designed to provide years of service under typical agricultural operating conditions. A tight fitting enclosure, combined with rubber covers for all connectors mean that typical dusty environments will not cause operational problems. While occasional splashing of water will not damage the unit, the Matrix Pro 570GS is not designed for direct exposure to rain. Take care not to operate the Matrix Pro GS in wet conditions.

Figure 1-1: Matrix Pro 570GS Console Front and Back



# Matrix® Pro 570GS • Matrix® Pro 840GS

INTRODUCTION

HOME

FULL SCREEN

SETUP

GNSS

IMPLEMENT

GUIDANCE

RATE CONTROL

APPENDIX

## Matrix Pro 840GS Console

The Matrix Pro 840GS is designed to provide years of service under typical agricultural operating conditions. A tight fitting enclosure, combined with rubber covers for all connectors mean that typical dusty environments will not cause operational problems. While occasional splashing of water will not damage the unit, the Matrix Pro 840GS is not designed for direct exposure to rain. Take care not to operate the Matrix Pro GS in wet conditions.

Figure 1-2: Matrix Pro 840GS Console Front and Back



## Buttons

### Power On/Off

On – Press the POWER button  to power on the console. Upon power up, the Matrix Pro GS will begin its start up sequence.

Off – Press and briefly hold the POWER button  until a confirmation screen acknowledges shut down mode.

**WARNING!** Wait 10 seconds before restarting the console.

### Home (Matrix Pro 840GS only)

The Home button  provides a shortcut to the Home screen.

### Up/Down (Matrix Pro 840GS only)

The Up/Down buttons  adjust the vehicle's view or perspective to the horizon from vehicle view to bird's eye view in Vehicle View and Field View Guidance.

## Additional Information

All changes are saved automatically.

The console needs to be cycled off and back on when changing or attaching equipment to the Matrix Pro GS system.

### Start Up Sequence

The console takes approximately two minutes to power up. During this time a series of screens will be displayed, LEDs will power on and off, and brightness levels will fluctuate. Once the power up sequence has completed, the Home screen will appear.

### Recommended Antenna Installation

The GNSS antenna should be mounted as far forward as possible on top of the cab on a metal surface of at least 4 in / 10 cm square.

## RealView® Camera

The TeeJet Technologies RealView camera allows video images to be displayed on the Matrix Pro GS screen. The camera can be pointed forward to enable RealView guidance over video, or it can be positioned to view other operational aspects of your equipment. The camera is equipped with a flexible RAM mount, integral sun shade and provides infrared illumination, allowing clear video images even in dark conditions.

## CONFIGURATIONS

The diagram that was in this location for previous software versions has been moved to the appendix.

## BASIC SCREEN USE





The Matrix Pro GS can be used as a simple current job system or advanced multi-job system. Regardless of which mode the console is in, the basic screen functions are the same.

- Bottom Tabs and Side Tabs access the various screens and sub-screens
- Warnings and Information Pop-ups inform user of console activities and details on setup or guidance functions
- Setup options can easily be set using the drop down menus or keyboard entry screens

To quickly find a setup feature, see “Matrix Pro GS Console Menu Settings” in this manual.

### Bottom Tab Keys

The bottom tab keys are always available on screen. These keys give access to jobs, setup options, and navigation.

-  Home/Job Screen
-  System Setup
-  Vehicle View Guidance
-  Field View Guidance
-  RealView guidance or RealView camera full screen video view

*NOTE: RealView Guidance options are only available with a camera installed on the system.*

Figure 1-3: Bottom Tab Keys



### Unavailable Options When Job is Active

When a job is active some setup options are unavailable: see “Matrix Pro GS Console Menu Settings” in this manual.

Figure 1-4: Examples of Unavailable Options

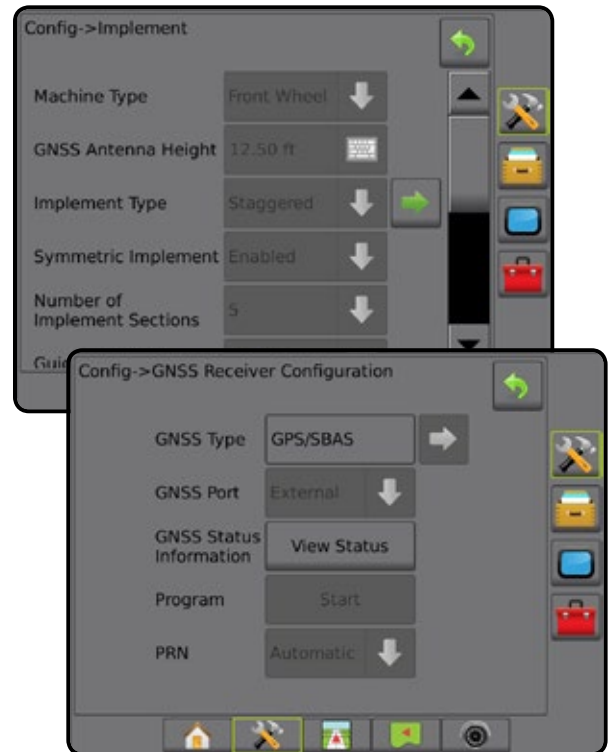

## Console Screen Colors



The console is available in six color schemes. From the System Setup Bottom Key, press CONSOLE side tab  and enter the **Display** options. Press DOWN arrow  to access the Color Scheme options to select color mode.

Figure 1-5: Color Schemes



## Simple or Advanced Mode

To change between simple mode and advanced mode, see the configuration chapter under Data → Options.

In simple mode, only one job will be available at a time. Only bounded area and coverage areas are displayed on the home screen. Only the current job is available for saving in Reports. Use with Fieldware Link is not available.

Figure 1-6: Simple Mode Home Screen

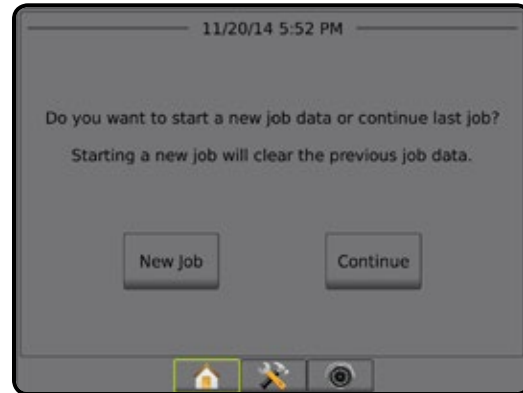

In advanced mode, more than one job will be available at any time. Client, farm, field and job names; bounded and coverage areas; application time; and distance from selected job are displayed on the home screen. All saved job profiles can be exported as a PDF, SHP or KML file to a USB drive using Data → Reports.

Client information, farm information, field information, and prescription maps can only be inputted using Fieldware Link. A job name can only be edited using Fieldware Link.

A user can duplicate jobs for reuse of boundaries, guidelines, coverage data and prescription maps using Fieldware Link or Data → Job Data → Manage in the console.

Figure 1-7: Advanced Mode Home Screen

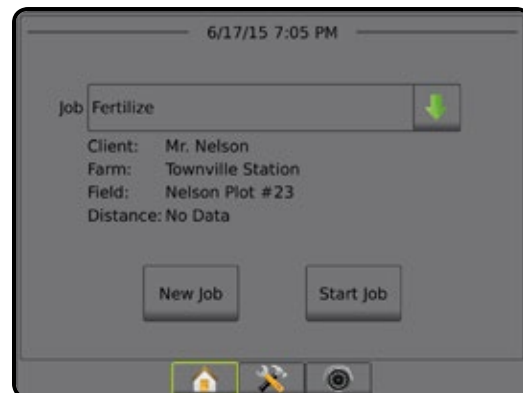



## Warnings and Information Pop-ups

A pop-up warning or information box will be displayed for approximately five (5) seconds. To remove the information box, tap anywhere on the screen.

Figure 1-8: Example of Information Text Box

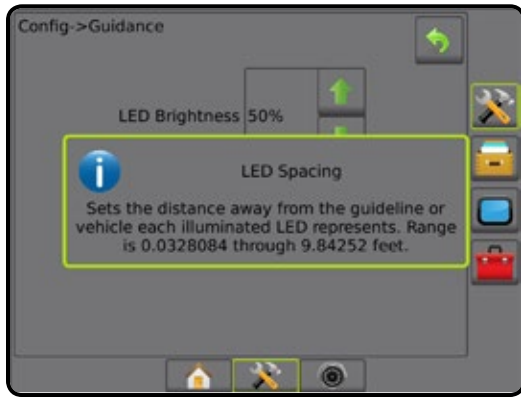

## Setup Option Information

Press the option's icon or option's name of any menu item to display a definition and range values of that item. To remove the information box, press anywhere on the screen.

Figure 1-9: Example of Information Text Box

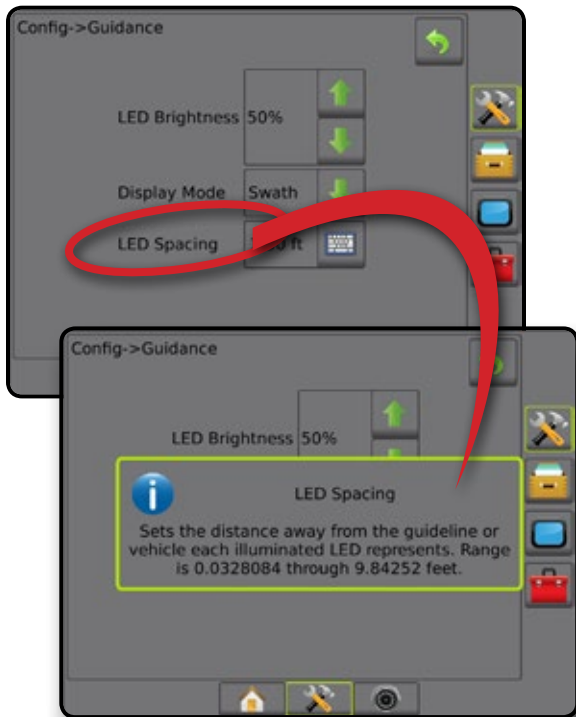

## Drop Down Menu Selections

Press DOWN arrow ↓ to access the options. Use the UP/DOWN arrows ▲ ▼ or slide bar if necessary to scroll through the extended list. Select the appropriate option. To close the list without selecting an option, tap anywhere on the screen outside the drop down menu.

Figure 1-10: Example of Drop Down Menu

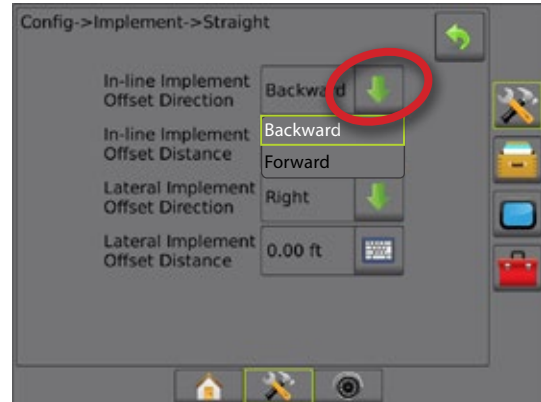

## Scrolling Screens

Some screens have more information or options that are visible beyond the current screen. Use the UP/DOWN arrows ▲ ▼ or slide bar to access additional options or information not currently visible on the screen.

Figure 1-11: Example of Scrolling Screen

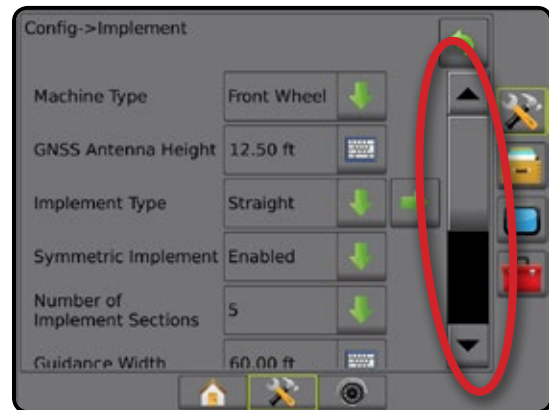

## Keyboard Entry Screen

Press the KEYPAD icon . Use the numeric keypad to enter a value.

Press the ACCEPT icon  to save the settings or the CANCEL icon  to leave the keypad without saving.

Figure 1-12: Example of Keyboard

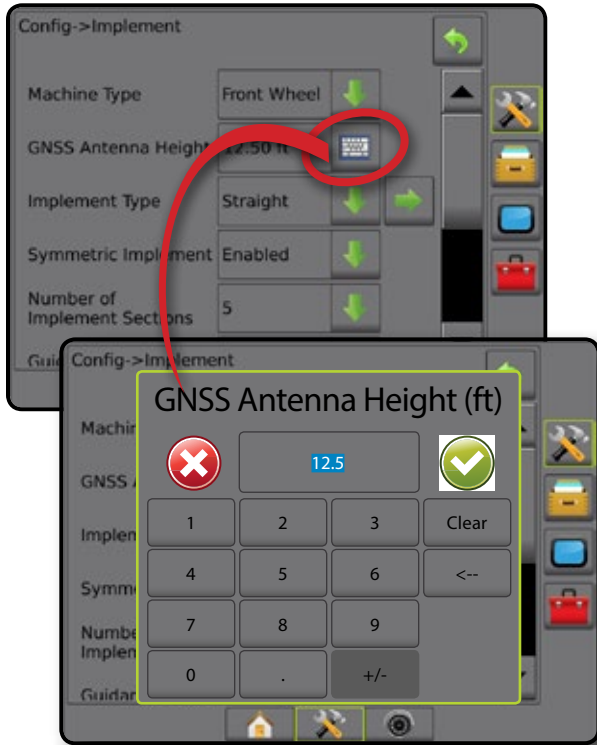

## Next Page

Press the NEXT PAGE arrow  to set up additional options for the selected item.

Figure 1-13: Example of Next Page



## Checkboxes

Press the CHECKBOX  /  to select or deselect.

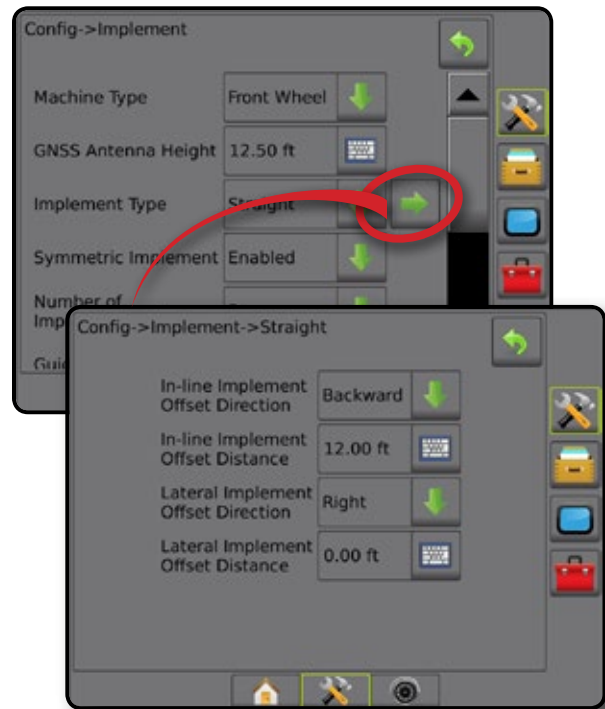
Figure 1-14: Examples of Checkboxes

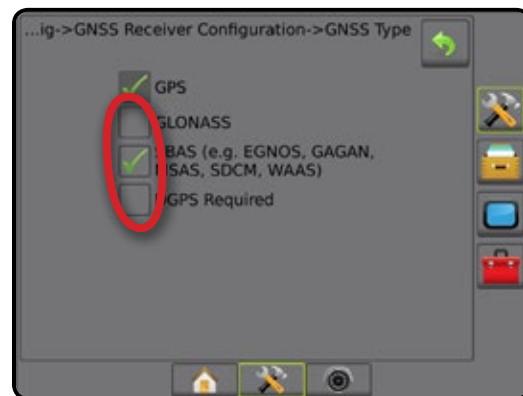

## CHAPTER 2 – JOBS / HOME SCREEN

Once the power up sequence has completed and the console is receiving GNSS, the Home screen will appear with the option to start a new job or continue an existing job.

**Setup for the specific machine and its components must be completed before starting a job.** Once a job is active, some setup options can no longer be changed. See “Matrix Pro GS Console Menu Settings” in the appendix of this manual.

To change between simple and advanced mode, go to Data-> Options-> Job Mode in the System Setup.

### Simple Mode

In simple mode, only one job will be available at a time. Only bounded area, coverage areas, and application time are displayed on the home screen. Only the current job is available for saving in Reports. Use with Fieldware Link is not available.

Figure 2-1: Simple Mode Home Screen

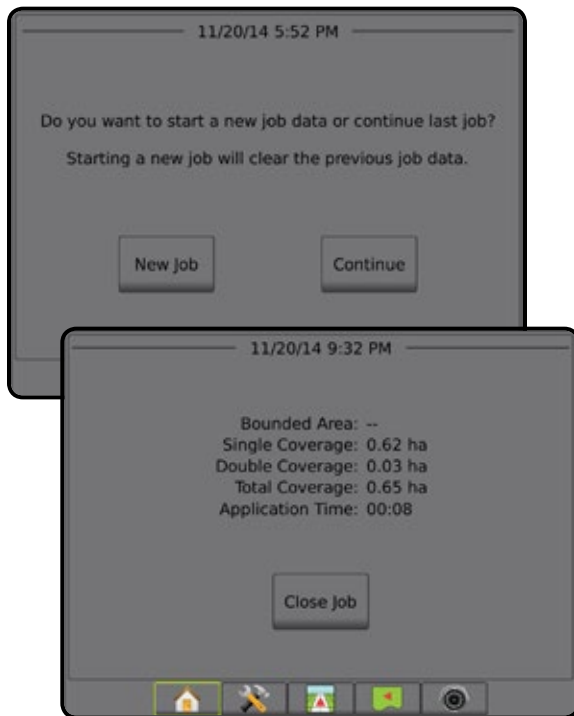

### Advanced Mode

In advanced mode, more than one job will be available at any time. Client, farm, field and job names; bounded and coverage areas; application time; and distance from selected job are displayed on the home screen. All saved job profiles can be exported as a PDF, SHP or KML file to a USB drive using Data -> Reports.

Client information, farm information, field information, and prescription maps can only be inputted using Fieldware Link. A job name can only be edited using Fieldware Link.

A user can duplicate jobs for reuse of boundaries, guidelines, coverage data and prescription maps using Fieldware Link or Data -> Job Data -> Manage in the console.

Figure 2-2: Advanced Mode Home Screen

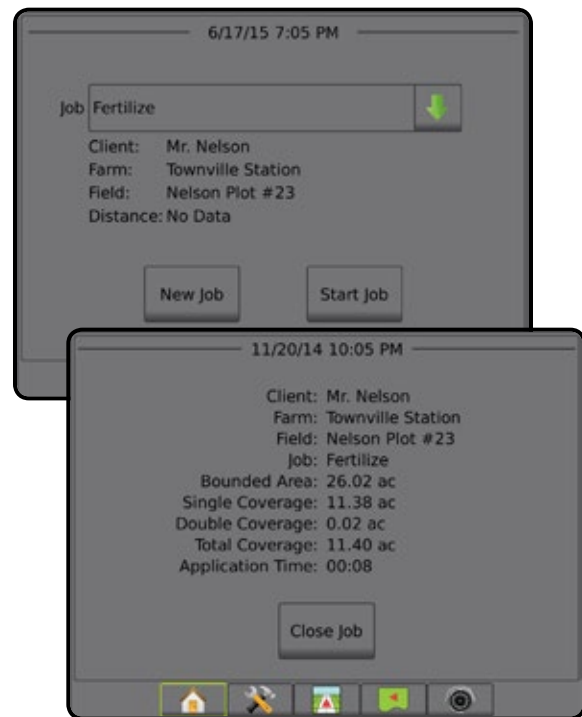

## SIMPLE MODE

Once the power up sequence has completed, the Home screen will appear with the option to start a new job or continue an existing job.

The console must have GNSS before starting or continuing a job.

### New Job

Starting a new job will clear the previous job data.

To start a New Job:

1. On the Home screen , press **New Job**.

The console will jump to Vehicle View.

### Continue Job

To continue the existing job:

1. On the Home screen , press **Continue**.

The console will jump to Vehicle View and begin providing navigation information.

If a selected job is in a UTM zone other than the current or adjacent UTM zone, **Continue** will be disabled.

*NOTE: For more information, see the UTM Zone Appendix.*

### Close Job

To close a job:

1. On the Home screen , press **Close Job**.

To create a report of the job when closing a job:

1. Insert a USB drive into the USB port of the console.
2. On the Home screen , press **Close Job**.
3. Select:
  - ▶ Yes – to create a report of the last job
  - ▶ No – to return to the Home screen without saving

## ADVANCED MODE

Once the power up sequence has completed, the Home screen will appear with the option to start a new job or continue an existing job.

The console must have GNSS before starting or continuing a job.

### New Job

Starting a new job will clear the previous job data.

To start a New Job:

1. On the Home screen , press **New Job**.

2. Press:

- ▶ Yes – to automatically generate a name
- ▶ No – to enter a name using the on screen keyboard



Client, farm, and field information are inputted using Fieldware Link.

The console will jump to Vehicle View.

### Start Job

The Matrix Pro GS is programmed with a field finder tool to assist the user in finding the job closest to the vehicle's location. With GPS acquired, the job pick list will be updated every ten seconds. During this update, the list of jobs is sorted by distance and the closest two jobs are displayed on the top of the list. The remaining jobs are listed beneath these.

To continue the existing job:

1. On the Home screen , press DOWN arrow  to access the list of jobs saved in the console.
2. Select the job name to be started/continued.
3. Press **Start Job**.

The console will jump to Vehicle View and begin providing navigation information.

### Distance

If a selected job is in a UTM zone other than the current or adjacent UTM zone, "Out of Range" will be displayed next to Distance, and **Start Job** will be disabled.

*NOTE: For more information, see the UTM Zone Appendix.*

If a selected job has no recorded information, Distance will show "No Data".

### Close Job

To close a job:

1. On the Home screen , press **Close Job**.

To create a report of the job when closing a job:

1. Insert a USB drive into the USB port of the console.
2. On the Home screen , press **Close Job**.
3. Select:
  - ▶ Yes – to create a report of the last job
  - ▶ No – to return to the Home screen without saving



## CHAPTER 3 – FULL SCREEN VIDEO VIEW

RealView Full Screen Video View allows live video input to be displayed. View video feed(s) and setup cameras without GNSS available. Options for RealView Guidance are not available on this screen.

- ▶ Single Camera – a single camera is directly attached to the console
- ▶ Video Selection Module – if a Video Selection Module (VSM) is installed on the system, two (2) video options are available:
  - One Camera View – one of up to eight camera inputs can be selected to change the view of the video input.
  - Split Camera View – one of two sets of four camera inputs (A/B/C/D or E/F/G/H) can be selected to divide the screen into four separate video feeds.

To adjust the camera view [reverse, upside down], go to Setup-> Configuration-> Video.

To enter Full Screen Video mode:





1. Press REALVIEW CAMERA FULL SCREEN VIDEO VIEW bottom tab .
2. Press REALVIEW OPTIONS tab  to display RealView options.
3. Select from:
  - ▶ Single Camera View  [VSM only] – one (1) of up to eight (8) camera inputs can be selected to change the view of the video input
  - ▶ Split Camera View  [VSM only] – one (1) of two (2) sets of four (4) camera inputs (A/B/C/D or E/F/G/H) can be selected to divide the screen into four separate video feeds
  - ▶ RealView Camera Image Capture  – saves a still photo of the current view on the screen to a USB drive

Figure 3-1: RealView Full Screen Video View



# Matrix® Pro 570GS • Matrix® Pro 840GS

## Camera Snapshot

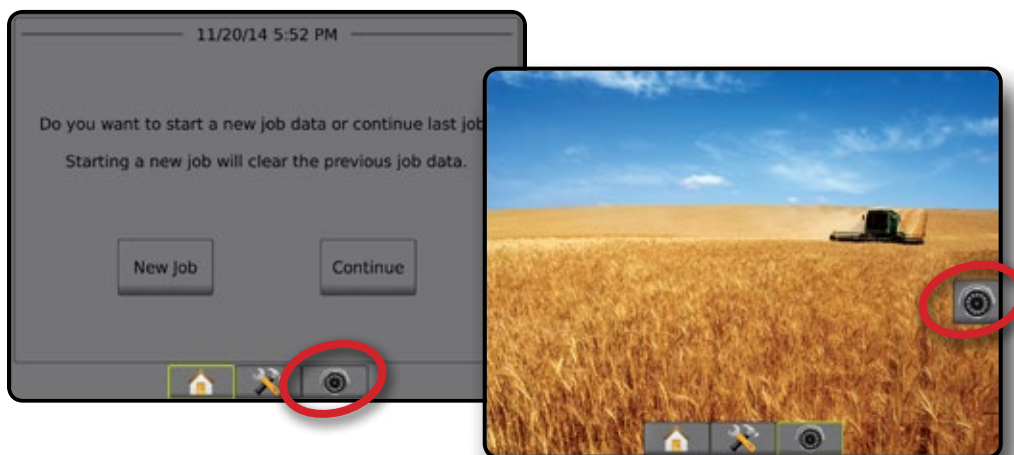
RealView Camera Snapshot saves a still photo of the current view on the screen to a USB drive.



1. Insert USB drive.
2. Press REALVIEW CAMERA FULL SCREEN VIDEO VIEW bottom tab .
3. Press REALVIEW OPTIONS tab  to display RealView options.
4. Press CAMERA SNAPSHOT icon .

Figure 3-2: RealView Camera Full Screen Video View



Figure 3-3: Single Camera Selection with VSM

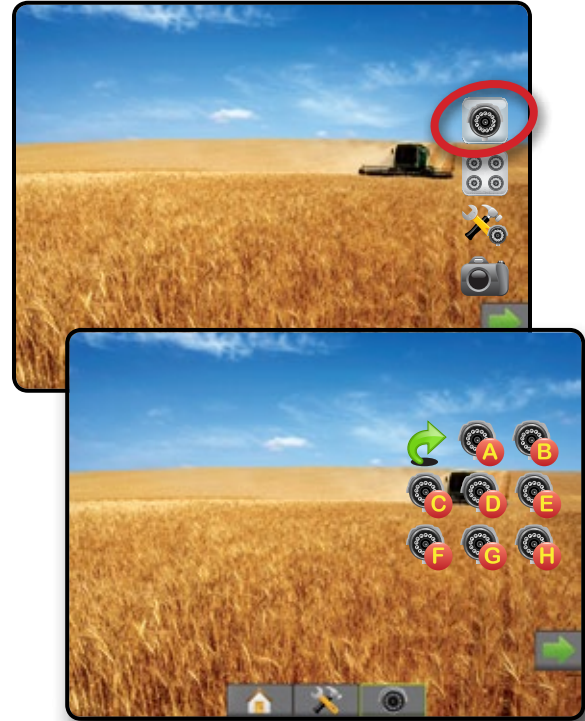





Figure 3-4: Select Split View with VSM



## VSM Camera Options

If a Video Selection Module (VSM) is installed on the system, two (2) video options are available:

1. Press REALVIEW CAMERA FULL SCREEN VIDEO VIEW bottom tab .
2. Press REALVIEW OPTIONS tab  to display RealView options.
3. Select from:
  - ▶ Single Camera View  – one (1) of up to eight (8) camera inputs can be selected to change the view of the video input.
  - ▶ Split Camera View  – one (1) of two (2) sets of four (4) camera inputs (A/B/C/D or E/F/G/H) can be selected to divide the screen into four separate video feeds.

## CHAPTER 4 – SYSTEM SETUP

System Setup is used to configure the console, the machine and its implements. Four side tabs access options for Machine/Implement Configuration, Data Management, Console Settings, and Tools.

### OVERVIEW

Four side tabs access setup options for:

#### Implement Configuration

- Implement (Straight, Spreader, or Staggered Implement configurations; Tip Selection information including Droplet Size Monitor, Reverse configuration)
- Guidance Sensitivity (Lightbar, External Lightbar)
- GNSS Receiver Configuration
- Video Configuration
- Sensors (Input/Output Module (IOM) Pressure Sensor)
- AutoSteer
  - ◀ FieldPilot (Valve Setup, Steering Settings, Valve Test, Valve Diagnostics, Steering Wheel Sensor, Steering Angle Sensor)
  - ◀ FieldPilot Pro / UniPilot Pro (Manage Vehicle, Calibrations, Adjustments, Select QI Values, Transport Mode, Service Mode)
- Tilt Correction

#### Data Management

- Job Data (Transfer, Manage)
- Reports
- Options (Job Mode)
- Machine Settings (Transfer, Manage)

#### Console Settings

- About (System Information)
- Display
- Cultural
- Audio Volume
- Demo GNSS
- Feature Unlock

#### Tools

- Upload Software
- Extras (Calculator, Units Converter)

Figure 4-1: Setup Options

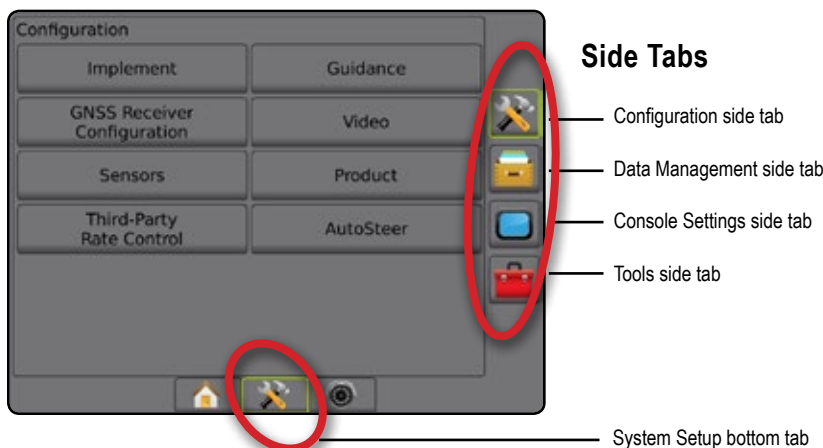

## CONFIGURATION

Configuration is used to configure the Implement, Guidance, GNSS Receiver, Video, Sensors, AutoSteer, and Tilt Correction.

*NOTE: Feature availability will vary depending on the devices available on the Matrix Pro GS system.*



1. Press SYSTEM SETUP bottom tab .
2. Press CONFIGURATION side tab .
3. Select from:
  - ▶ Implement – used to set (as appropriate) machine type, GNSS antenna height, implement type, symmetric implement layout, section output modules, number of implement sections, guidance width, application/working width, droplet size monitor, tip selection, tip spacing, BoomPilot start mode, Reverse Sense Module
    - In Straight Mode – in-line/lateral implement offset direction/distance, overlap percentage, implement delay on/off time
    - In Spreader Mode:
      - TeeJet – antenna to disks distance, lateral implement offset direction/distance, overlap percentage, delay on/off times, spread offset distance, section offset distances, section lengths
      - OEM – antenna to disks distance, lateral implement offset direction/distance, start/stop distance, section start/stop offset distances
    - In Staggered Mode – in-line/lateral section 1 offset direction/distance, overlap percentage, delay on/off times, section offsets
  - ▶ Guidance – used to set the distance around the guideline that is perceived as zero error
  - ▶ GNSS Receiver Configuration – used to establish GNSS type, port, and PRN, as well as to view GNSS status information
  - ▶ Video – used to set up individual cameras
  - ▶ Sensors – used to establish pressure sensor settings
  - ▶ AutoSteer – used to enable/disable and calibrate assisted/auto steering
    - FieldPilot – used to establish valve setup settings, steering settings, steering wheel and steering angle sensor settings, and to perform valve tests or valve diagnostics
    - FieldPilot Pro / UniPilot Pro – used to manage vehicle settings, calibrate sensors, select QI values, as well as establish transport mode and service mode
  - ▶ Tilt Correction – used to enable/disable and calibrate the tilt correction function, and improve application on hilly or sloped terrain

Figure 4-2: Configuration Options



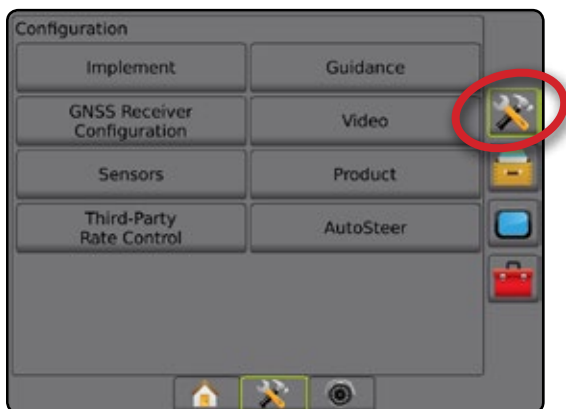

## Implement

Implement Setup is used to establish the various settings associated with straight mode, spreader mode, or staggered mode. Available settings will vary depending on the specific equipment present in the system.

This section includes setup options for these implement configurations:

- ▶ Single Section
- ▶ Multiple Sections with Section Driver Module or Switch Function Module

*NOTE: For more information, see the Implement chapter of this manual.*

### Implement Type

Implement type selects the type of application pattern that most closely represents your system.

- In Straight Mode – the boom sections have no length and are on a line a fixed distance from the antenna
- In Spreader Mode – a virtual line is created in line with the delivery disks from which the application section or sections can vary in length and can be at different distances from the line (availability depends on the specific equipment in the system)
- In Staggered Mode – a virtual line is created in line with Section 1 from which the application section or sections have no length and can be at different distances from the antenna (availability depends on the specific equipment in the system)

*NOTE: For more information, see "Implement Type" in the Implement chapter of this manual.*

Figure 4-3: Implement Type – Straight



Figure 4-4: Implement Type – Spreader

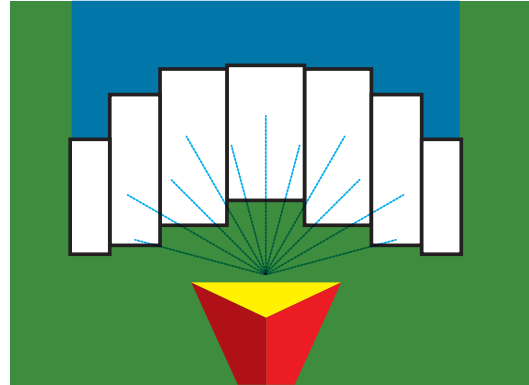



Figure 4-5: Implement Type – Staggered



### Single Section Setup

Single Section Setup is used when a SmartCable, Section Driver Module (SDM), or Switch Function Module (SFM) is not on the system (that is, no section control is present). The entire boom or delivery area is considered to be one section.

1. Press CONFIGURATION side tab .
2. Press **Implement**.
3. Select from:
  - ▶ Machine Type [when available] – used to select the type of machine that most closely represents your machine
  - ▶ GNSS Antenna Height [when available] – used to measure the height of the antenna from the ground
  - ▶ Implement Type – used to select the layout of the sections for the applied product location
  - ▶ Guidance Width – used to set the distance between guidelines
  - ▶ Working Width [Spreader Implement Type] – used to enter the total width of the implement
  - ▶ Application Width [Straight Implement Type] – used to enter the total width of the implement
  - ▶ Droplet Size Monitor [when available] – used to enable droplet size monitoring for up to five preselected sprayer tips



- ▶ Tip Selection [when available] – used to select the type of sprayer tip (series and capacity) for determining droplet size information
  - ▶ Applied Alert – used to establish an alert to signal when exiting or entering an applied area
  - ▶ BoomPilot Start Mode – used to establish whether BoomPilot will be controlled by speed or by the BoomPilot icon
  - ▶ BoomPilot Icon – used to activate the guidance screen icon for manually controlling on-screen application painting
4. Press NEXT PAGE arrow  to set up specific implement options. See the Implement chapter for details.
  5. Press RETURN arrow  or CONFIGURATION side tab  to return to the main Configuration screen.

Figure 4-6: Implement – Single Section Setup



## Multiple Sections with SDM/SFM Setup

Multiple Sections with SDM/SFM Setup is used when a Section Driver Module (SDM) or Switch Function Module (SFM) is on the system. The boom or delivery area can include up to 15 sections of varying width and (in spreader mode) length. Additional options available with an SDM include Application Overlap, Application Delay, and Staggered Mode.

The Switch Function Module enables manual and automated control of up to 20 booms.





1. Press CONFIGURATION side tab .
2. Press **Implement**.
3. Select from:
  - ▶ Machine Type [when available] – used to select the type of machine that most closely represents your machine
  - ▶ GNSS Antenna Height [when available] – used to measure the height of the antenna from the ground
  - ▶ Implement Type – used to select the layout of the sections for the applied product location
  - ▶ Symmetric Implement – used to establish if sections are paired and therefore share the same width, offset, and length values
  - ▶ Multiple Section Output Modules – used to enable use of multiple section output modules on the CAN bus
  - ▶ Number of Implement Sections – used to select the number of implement sections
  - ▶ Guidance Width – used to enter the distance between the guidelines
  - ▶ Application Width [Straight or Staggered Implement Type] – used to enter the total width of all sections of the implement
  - ▶ Working Width [Spreader Implement Type] – used to enter the total width of the implement
  - ▶ Droplet Size Monitor [when available] – used to enable droplet size monitoring for up to five preselected sprayer tips
  - ▶ Tip Selection [Straight or Staggered Implement Type] – used to select the type of sprayer tip
4. Press NEXT PAGE arrow  to set up specific implement options. See the Implement chapter for details.
5. Press RETURN arrow  or CONFIGURATION side tab  to return to the main Configuration screen.

Figure 4-7: Implement – Multiple Sections with SDM or SFM Setup



## Droplet Size Monitor

When the system includes a Pressure Sensor Interface Kit (PSIK), or a Dual Control Module with Product Control Application Type set to "Liquid" and the Primary Sensor or a Monitor set to "Pressure", Droplet Size Monitor can be enabled/disabled. The DSM then becomes available on the operation screens.

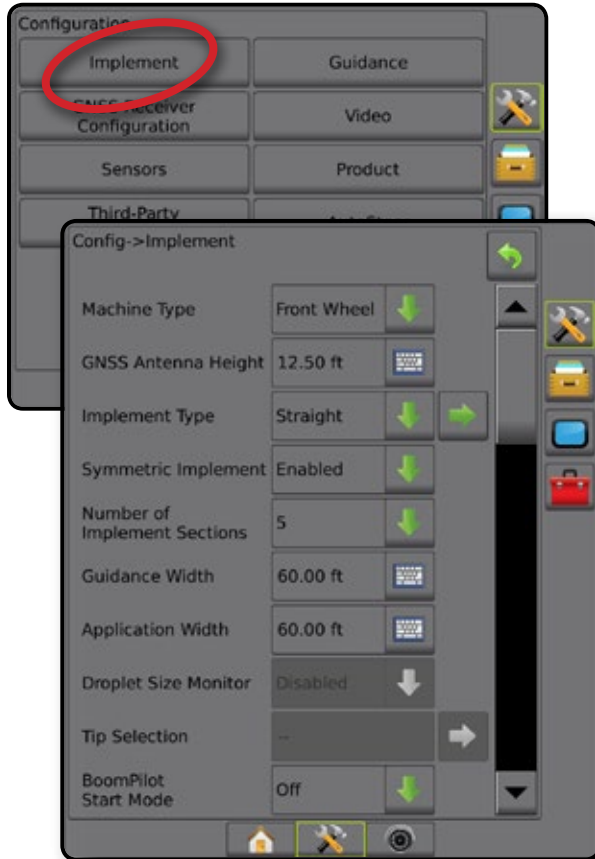
*NOTE: For more information, see "Droplet Size Monitor" in the Implement chapter of this manual.*



1. Press CONFIGURATION side tab .
2. Press **Implement**.
3. Select if Droplet Size Monitor is enabled or disabled. (If enabling, also read displayed information and press **Accept**.)
4. Press RETURN arrow  or CONFIGURATION side tab  to return to the main Configuration screen.

Figure 4-8: Droplet Size Monitor



## Tip Selection

Tip Selection enables up to five (5) tips to be preset for quick recall, and the current tip to be selected.

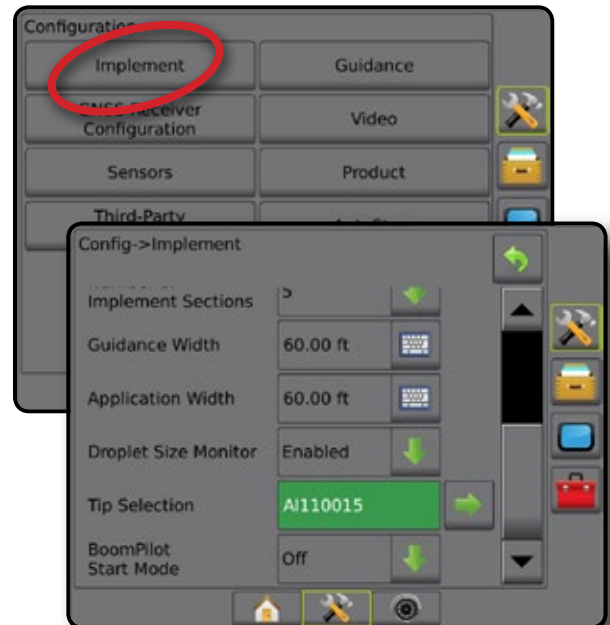
*NOTE: For more information, see "Tip Selection" in the Implement chapter of this manual.*





1. Press CONFIGURATION side tab .
2. Press **Implement**.
3. Press Tip Selection NEXT PAGE arrow .
4. Select from:
  - ▶ Tip Preset 1-5 – selects up to five (5) tips for quick recall, and selected the current tip for determining droplet size information
  - ▶ Current Tip – displays the current tip
5. Press RETURN arrow  or CONFIGURATION side tab  to return to the main Configuration screen.

Figure 4-9: Tip Selection



## Reverse Sense Module

Reverse Sense Module Setup is used when adding a Reverse Sense Module or SCM Pro (Steering Control Module Pro) to any configuration.

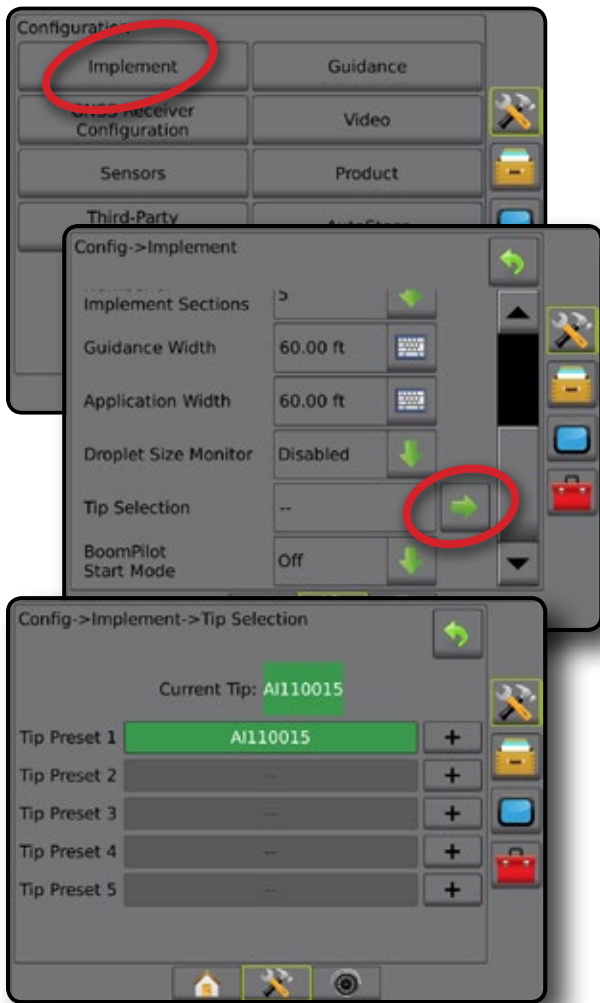
*NOTE: For more information, see "Reverse Sense Module" in the Implement chapter of this manual.*



1. Press CONFIGURATION side tab .
2. Press **Implement**.
3. Select:
  - ▶ Allow BoomPilot in Reverse [when available] – used to enable BoomPilot function while traveling in reverse
  - ▶ Reverse Signal Delay – used to set the delay when going from forward to reverse or reverse to forward, after which the vehicle icon on a navigation screen changes direction
4. Press RETURN arrow  or CONFIGURATION side tab  to return to the main Configuration screen.

Figure 4-10: Reverse Sense Module



## Guidance [Lightbar]

Guidance options are used to configure the Cross Track Error shown on the on the lightbar.

*NOTE: In previous software versions, this feature was referred to as "Lightbar".*

An optional External Lightbar Module (ELM) may be used to provide additional guidance information.



1. Press CONFIGURATION side tab .
2. Press **Guidance**.
3. Select from:
  - ▶ LED Brightness – used to adjust the brightness of the LEDs
  - ▶ Display Mode – used to determine whether the lightbar represents the swath or vehicle
    - When set to "swath", the LEDs represent guideline location and the moving LED represents the vehicle
    - When set to "vehicle", the centre LED represents vehicle location and the moving LED represents the guideline
  - ▶ LED Spacing – used to set the distance away from the guideline or vehicle each illuminated LED represents
4. With an External Lightbar Module (ELM), select from:
  - ▶ External Lightbar – enable/disable use of the external lightbar
  - ▶ External Lightbar LED Brightness – adjusts the brightness of the external lightbar LEDs
  - ▶ External Lightbar Text Brightness – adjusts the brightness of the external lightbar text
  - ▶ External Cross Track – enable/disable display of cross track error information on the external lightbar
  - ▶ External Swath Number – enable/disable display of swath number information on the external lightbar
  - ▶ External Speed – enable/disable display of speed information on the external lightbar
  - ▶ External Actual Rate [available with Third-party Rate Control] – enable/disable display of actual rate information on the external lightbar
  - ▶ External Target Rate [available with Third-party Rate Control] – enable/disable display of target rate information on the external lightbar.
  - ▶ External Applied Product [available with Third-party Rate Control] – enable/disable display of applied product information on the external lightbar
5. Press RETURN arrow  or CONFIGURATION side tab  to return to the main Configuration screen.

Figure 4-11: Guidance with External Lightbar Module (ELM).



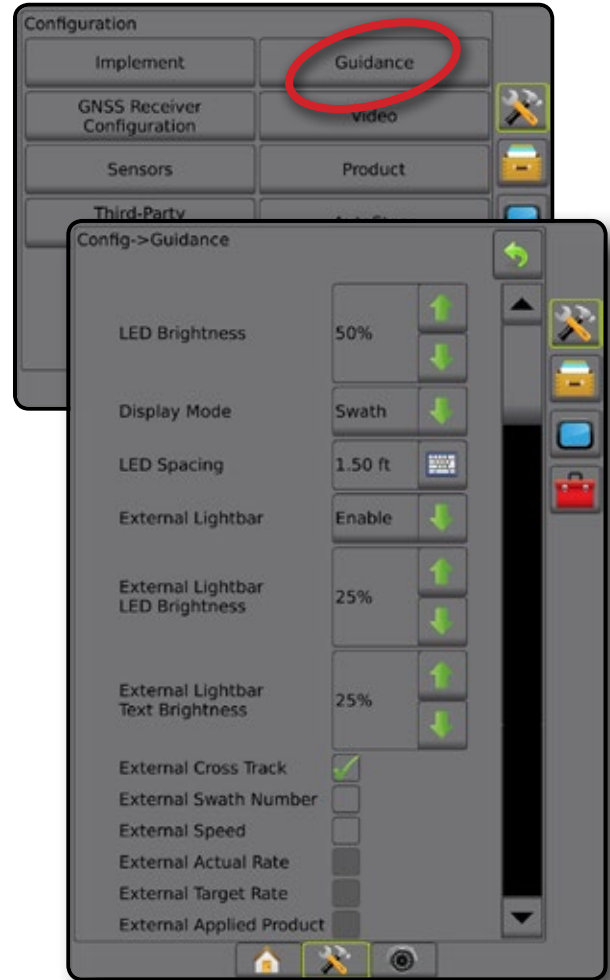

## AutoSteer

When a Steering Control Module (SCM or SCM Pro) is present, Assisted/Auto Steering options will be available.

*NOTE: For detailed setup instructions, refer to your specific assisted/auto steering installation manual.*

AutoSteer setup is used to enable/disable and calibrate assisted/auto steering

- FieldPilot [using a SCM] – used to establish valve setup settings, steering settings, steering wheel and steering angle sensor settings, and to perform valve tests or valve diagnostics
- FieldPilot Pro / UniPilot Pro [using a SCM Pro] – used to manage vehicle settings, calibrate sensors, select QI values, as well as establish transport mode and service mode

### Assisted/Auto Steering Unavailable

If an assisted/auto steering system is not installed, setup options will not be available.

Figure 4-12: Assisted/Auto Steering Not Detected

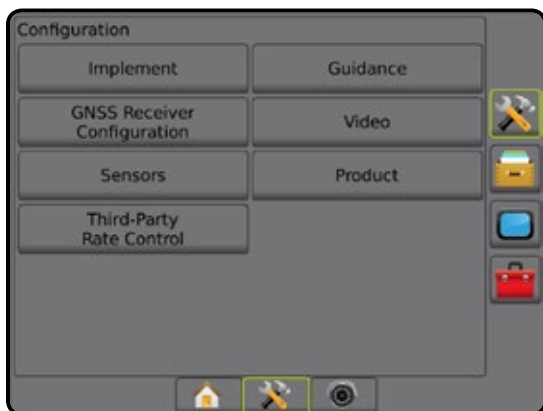

### FieldPilot [using a SCM]

1. Press CONFIGURATION side tab
2. Press **AutoSteer**.
3. Select if assisted/auto steering is enabled or disabled.
4. When enabled, select from:
  - ▶ Valve Setup – used to configure Valve Type, Valve Frequency, Minimum Duty Cycle Left/Right and Maximum Duty Cycle Left/Right
  - ▶ Steering Settings – used to establish Coarse Steering Adjustment, Fine Steering Adjustment, Deadband, and Lookahead
  - ▶ Valve Test – used to verify if steering is directed correctly
  - ▶ Valve Diagnostics – used to test the valves to see if they are connected properly
  - ▶ Options: Steering Wheel Sensor – used to select whether the steering disengage sensor is magnetic or pressure sensor based

- ▶ Steering Angle Sensor – used to establish and calibrate the Steering Angle Sensor (SAS) as the primary feedback sensor for auto steering

5. Press RETURN arrow or CONFIGURATION side tab to return to the main Configuration screen.

Figure 4-13: AutoSteer



### FieldPilot Pro / UniPilot Pro [using a SCM Pro]

1. Press CONFIGURATION side tab .
2. Press **AutoSteer**.
3. Select from:
  - ▶ Manage Vehicles – Allows the operator to select, edit, copy, delete, or export/import vehicle profiles as well as
    - NOTE: When creating a new vehicle profile or editing an existing vehicle profile, Manual Disengage should be set up before doing the Automatic Calibration.*
    - ◀New – creates a new vehicle profile.
    - ◀Load – activates the highlighted vehicle profile.
    - ◀Edit – allows the operator to modify the parameters of the active vehicle profile including Wheel Base, Antenna In-line Offset Direction & Distance, Antenna Lateral Offset Direction & Distance, Antenna Height, SCM Pro In-line Offset Direction & Distance, SCM Pro Lateral Offset Direction & Distance, SCM Pro Height, and SCM Pro Orientation
    - ◀Copy – duplicates the active vehicle profile



◀ Automatic Calibration  – guides the operator through the calibration process for the active vehicle. The calibration steps teach the FieldPilot Pro system or UniPilot Pro system the characteristics of the vehicle and the steps are critical to achieve optimal control performance.

◀ Adjust – after the vehicle has been calibrated, it should perform adequately for most normal field operations. However in some situations, it may be necessary to adjust the steering performance to take into account field conditions, implement selection, traveling speed, etc. The Vehicle Adjust screen enables the operator to adjust the vehicle steering performance to match these changing conditions.

– Manual Disengage  – adjust the limit at which FieldPilot Pro or UniPilot Pro is disengaged when the steering wheel is being turned manually.

◀ Delete – allows the operator to delete a vehicle profile that is no longer needed. The active vehicle profile cannot be deleted.

▶ Select QI Values – allows the user to configure the minimum GNSS position quality (precision level) requirements to allow FieldPilot Pro or UniPilot Pro to be activated and remain engaged

▶ Maximum DOP – Maximum DOP (Dilution of Precision) sets the maximum value of the overall quality of a GNSS position based on the satellite geometry that is used to calculate it. A value of 1 to 2 is excellent, 2-5 is good, 5-10 is moderate, 10-20 is fair, and anything over 20 is poor.

Assisted/automatic steering should be performed when the DOP is below 4 for best results.



▶ Transport Mode – When enabled, all AutoSteer functions are disabled and cannot be activated.

▶ Service Mode – When enabled, WiFi will be available through the next power cycle so a technician can connect to the SCM Pro directly for service tasks.

▶ Operator Presence – Set Operator Presence Switch response

– Enable - FieldPilot Pro or UniPilot Pro not possible with switch OPEN. Recommended setting regardless of presence/absence of Operator Presence switch.

– Disable - Operator Presence detection has been deactivated and will not affect FieldPilot Pro or UniPilot Pro. This is a critical safety feature that should only be disabled when instructed by the machine manufacturer or TeeJet Technologies.

4. Press RETURN arrow  or CONFIGURATION side tab  to return to the main Configuration screen.

## Active Vehicle

Active Vehicle is highlighted with a set of asterisks (\*). This is the vehicle profile the FieldPilot Pro system or UniPilot Pro system is currently programmed to use.



Figure 4-14: FieldPilot Pro or UniPilot Pro Setup Opening Screen



## Tilt Correction

When a Steering Control Module (SCM) or Tilt Gyro Module (TGM) is present, Tilt Correction is available. This corrects the GNSS signal to compensate for errors in the GNSS position while operating on hilly or sloped terrain.

For detailed setup instructions, refer to your specific assisted/auto steering installation manual or tilt setup bulletin.

1. Press CONFIGURATION side tab .
2. Press **Tilt Correction**.
3. Select if Tilt Correction is enabled or disabled.
4. When enabled, select **Field Level** to calibrate tilt correction.
5. Press RETURN arrow  or CONFIGURATION side tab  to return to the main Configuration screen.

*NOTE: If FieldPilot or UniPilot is being used, a Tilt Gyro Module is built into the system.*

*NOTE: Antenna Height must be entered prior to Tilt Calibration.*

Figure 4-15: Tilt Correction



### Field Level Unavailable

If the vehicle is in motion, the field level option will not be available. Vehicle must be stopped for at least 10 seconds to begin to calibrate tilt correction.

### Tilt Correction Unavailable

If an SCM or TGM is not connected, setup options will not be available.

## GNSS Receiver Configuration

GNSS Receiver Configuration is used to configure GNSS Type, GNSS Port, and PRN, as well as to view GNSS status information.

*NOTE: For more information, see the GNSS Receiver Configuration chapter of this manual.*

*These settings are required for assisted/auto steering, tilt sensor operation, and rate control functionality, as well as proper implement operation.*





1. Press CONFIGURATION side tab .
2. Press **GNSS Receiver Configuration**.
3. Select from:
  - ▶ GNSS Type – sets to accept GNSS source transmissions: GPS, GLONASS, SBAS (with or without DGPS Required)
  - ▶ GNSS Port – sets GNSS communication port to either Internal or External
  - ▶ GNSS Status Information – displays current GNSS status information
  - ▶ Program – only TeeJet support technicians should use this feature
  - ▶ PRN – selects the SBAS PRN that will provide GNSS differential correction data. Set to **Automatic** for automatic PRN selection.
4. Press NEXT PAGE arrow  to set up the selected specific GNSS options.
5. Press RETURN arrow  or CONFIGURATION side tab  to return to the main Configuration screen.

Figure 4-16: GNSS Receiver Configuration Options



### PRN Not Shown

PRN options are only available with SBAS GNSS Type selected.

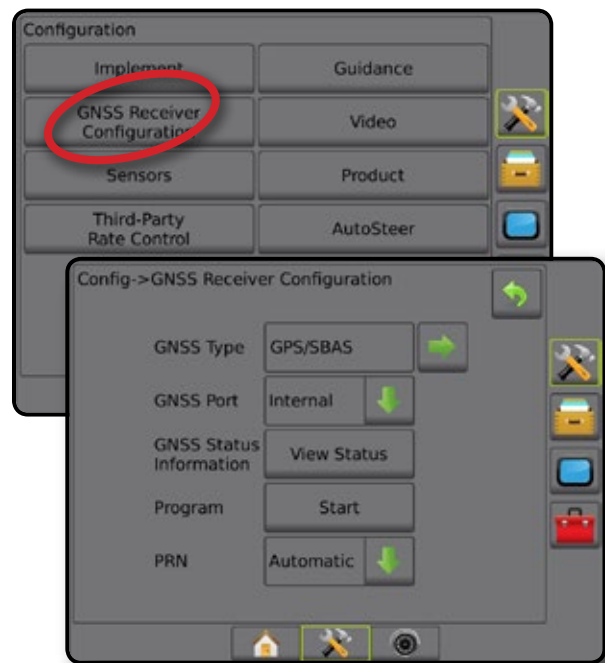
## Video

Video Setup is used to set up a single directly connected camera or individual cameras while using an Eight (8) Channel or Four (4) Channel Video Selector Module (VSM). Up to 8 cameras can be configured if a VSM is installed.

1. Press CONFIGURATION side tab .
2. Press **Video**.
3. Select the appropriate check box(es):
  - ▶ Reverse – **ABC**
  - ▶ Upside Down – **VBC**



For normal video view **ABC** un-check all check boxes.
4. Press RETURN arrow  or CONFIGURATION side tab  to return to the main Configuration screen.

Figure 4-17: Video with 4 Channel VSM Options



### Video Setup Unavailable

If a camera or VSM is not connected, setup options will not be available.

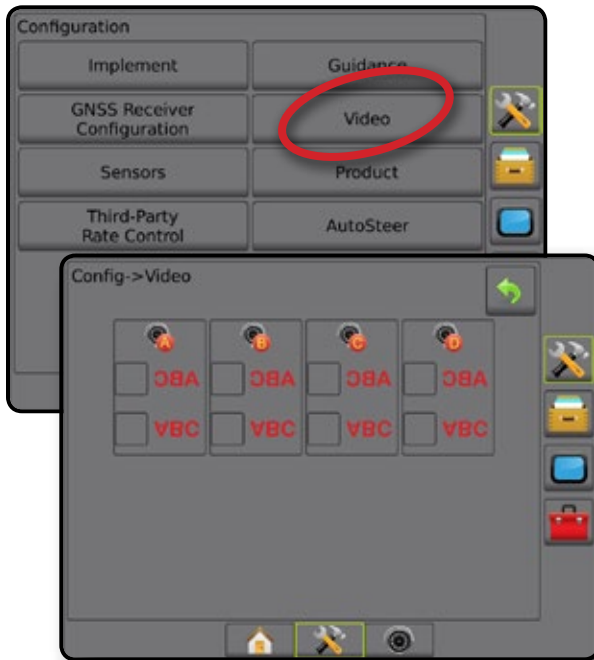
## Sensors

When a Pressure Sensor Interface Kit (specifically, an Input Output Module (IOM)) is on the system, options to set up and configure the sensor will be available.

*NOTE: These settings are not affected by use of a Pressure Sensor on a Dual Control Module.*

1. Press CONFIGURATION side tab .
2. Press **Sensors**.

Figure 4-18: Sensors



The Pressure Sensor Interface Kit is recognized on the Console About screen as an Input/Output Module (IOM).

Figure 4-19: Input/Output Module

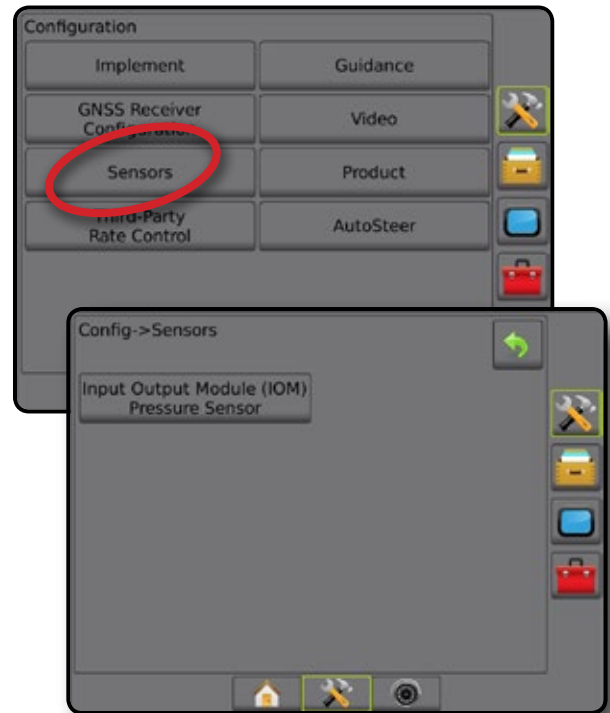
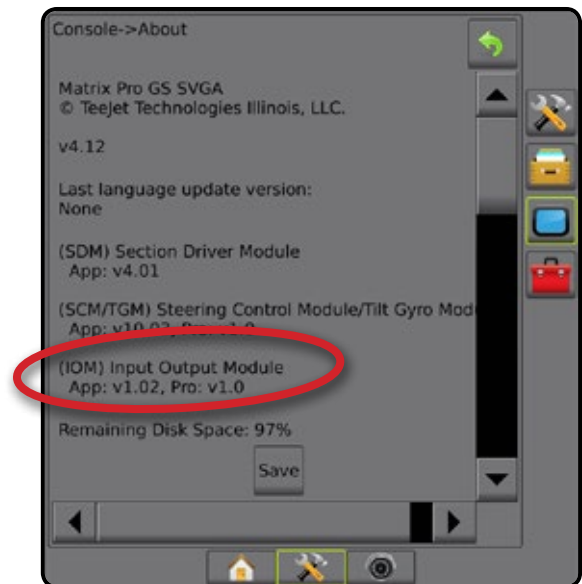

## Sensors Unavailable

If a Pressure Sensor Interface Kit is not installed, setup options will not be available.

## Input/Output Module Pressure Sensor

When a Pressure Sensor Interface Kit is present, Pressure Sensor options are used to enter the sensor manufacture's maximum pressure rating and set high and low user determined pressure alarms.



1. Press CONFIGURATION side tab .
2. Press **Sensors**.
3. Press **Input Output Module (IOM) Pressure Sensor**.
4. Select from:
  - ▶ Maximum Pressure Rating – used to establish the maximum pressure rating of the pressure sensor as recommended by the manufacturer
  - ▶ Low Pressure Alarm – used to enter the user determined low pressure point at which the alarm will sound
  - ▶ High Pressure Alarm – used to enter the user determined high pressure point at which the alarm will sound
5. Press RETURN arrow  or CONFIGURATION side tab  to return to the main Configuration screen.

Figure 4-20: Input/Output Monitor Pressure Sensor Options



## Droplet Size Monitor

If a Pressure Sensor Interface Kit is being used, the Droplet Size Monitor options will be available.

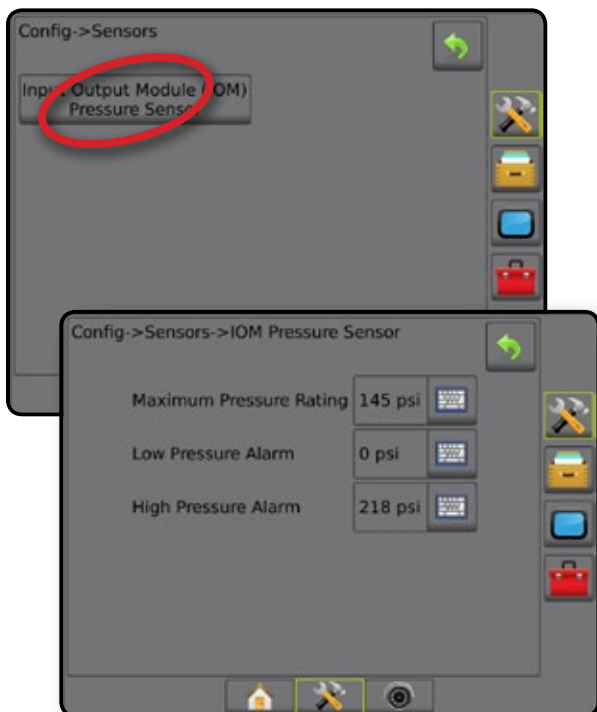

1. Press CONFIGURATION side tab .
2. Press **Implement**.
3. Press **Droplet Size Monitor**.
4. Select if droplet size monitor is enabled or disabled.
5. Press RETURN arrow  or CONFIGURATION side tab  to return to the main Configuration screen.

Figure 4-21: Droplet Size Monitor





## DATA MANAGEMENT

Data Management allows for transfer and management of job data, reporting of job data, changing of job mode, and transfer and management of machine settings.



1. Press SYSTEM SETUP bottom tab .
2. Press DATA MANAGEMENT side tab .
3. Select from:
  - ▶ Job Data – in advanced job mode, used to transfer job information (delete, import, export) and manage job information (create a new job, delete a job, or copy a job's Guidelines, Boundaries, Applied Data, and/or Prescription Map to a new job)
  - ▶ Reports – used to create job reports and save them to a USB drive
  - ▶ Options – used to select simple job mode or advanced job mode
  - ▶ Machine Settings – used to transfer machine settings (delete, import, export) and manage machine setting (create a new machine setting, copy a machine setting, delete a machine setting, save the current machine setting to the selected file, or load the selected file's machine setting)

Figure 4-22: Data Management Options



### Job Data

When in advanced job mode, job data options are used to transfer job information (delete, import, export) and manage job information (create a new job, delete a job, or copy a job's Guidelines, Boundaries, Applied Data, and/or Prescription Map to a new job).

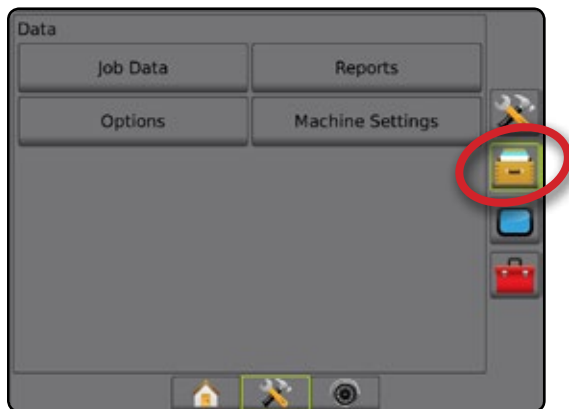
Job Data includes:

- Job name
- Client, Farm, and Field names
- Boundary
- Coverage Area
- Guidelines
- Maps (Coverage, Prescription, Application, Preset Target Rate)
- Tip Faults



1. Press DATA MANAGEMENT side tab .
2. Press **Job Data**.
3. Select from:
  - ▶ Transfer – when in advanced job mode, allows the transfer of selected jobs to or from a USB drive, as well as deleting jobs
  - ▶ Manage – when in advanced job mode, allows the creation of a new empty job, copying of a selected job's Guidelines, Boundaries, Applied Data, and/or Prescription Map to a new job, as well as deleting a selected job
4. Press RETURN arrow  or DATA MANAGEMENT side tab  to return to the main Data Management screen.

Figure 4-23: Job Data Options



### Job Data Unavailable

When in simple job mode, job data options will not be available.

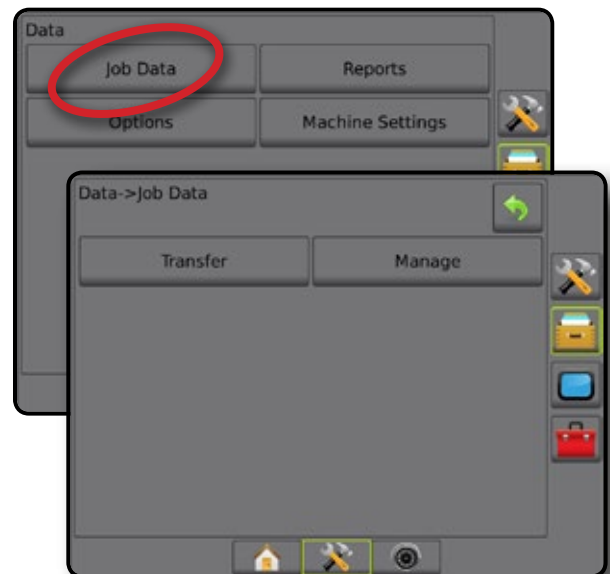
Figure 4-24: Job Data Unavailable

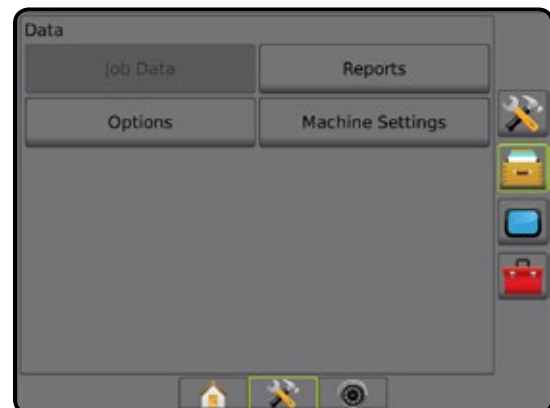



## Transfer

When in advanced job mode, the job data transfer screen allows the transfer of selected jobs to or from a USB drive, as well as deleting jobs.

Jobs transferred to a USB storage device can be opened and updated using Fieldware Link. In Fieldware Link a user can input client, farm and field data as well as copy/edit jobs for reuse of boundaries and guidelines. From Fieldware Link, jobs can be ported back to a USB storage device to be moved back onto the console internal storage for use.

*NOTE: When a job is active/started, Transfer options are not available for selection. Stop the current job to enable the function.*

*Jobs transferred to a storage device are removed from the console and are no longer available for use.*







1. Press DATA MANAGEMENT side tab .
2. Press **Job Data**.
3. Press **Transfer**.
4. Select from:
  - ▶ Move Job Data to USB Storage  – used to move job data from internal storage to USB storage
  - ▶ Move Job Data to Internal Storage  – used to move job data from USB storage to internal storage
  - ▶ Delete Job Data  – used to delete job data from internal storage
5. Press RETURN arrow  or DATA MANAGEMENT side tab  to return to the main Data Management screen.

Figure 4-25: Job Data – Transfer



## Manage

When in advanced job mode, the job data manage screen allows the creation of a new empty job, copying of a selected job's Guidelines, Boundaries, Applied Data, and/or Prescription Map to a new job, as well as deleting a selected job.

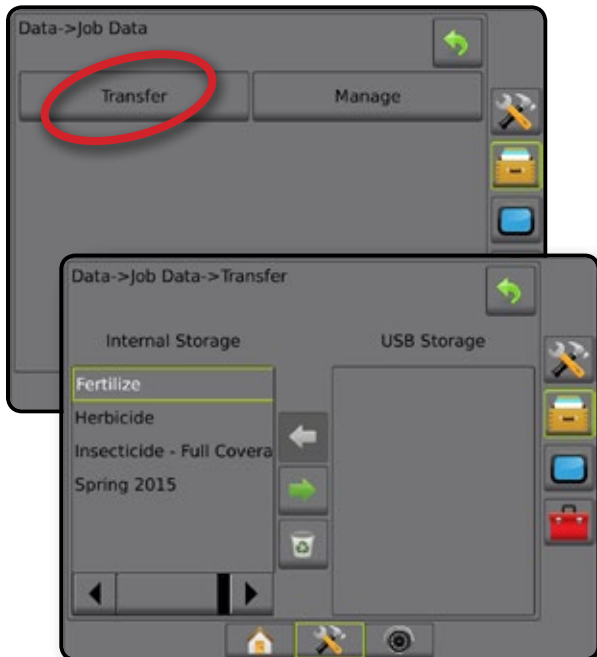
*NOTE: When a job is active/started, Manage options are not available for selection. Stop the current job to enable the function.*



1. Press DATA MANAGEMENT side tab .
2. Press **Job Data**.
3. Press **Manage**.
4. Select from:
  - ▶ New – used to create a new empty job with no associated Guidelines, Boundaries, Applied Data, or Prescription Map
  - ▶ Copy – used to copy the selected job's Guidelines, Boundaries, Applied Data, and/or Prescription Map into a new job
  - ▶ Delete – used to delete job data from internal storage
5. Press RETURN arrow  or DATA MANAGEMENT side tab  to return to the main Data Management screen.

Figure 4-26: Job Data – Manage







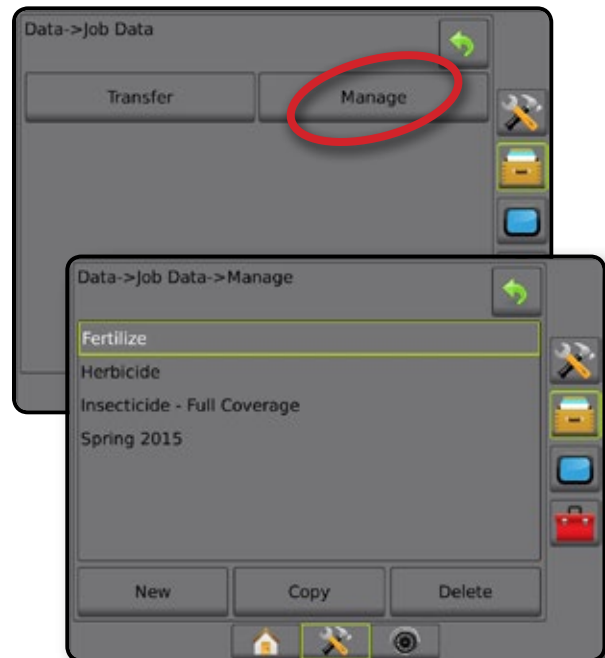



## Reports

Reports is used to create job reports and save them to a USB drive.

**NOTE:** If Simple Job Mode is selected in the Options page, only the current job can be saved.

When a job is active/started, Reports are not available for selection. Stop the current job to enable the function.

When closing a job with a USB drive in the console, you get the option to create a report on the current job.

1. Press DATA MANAGEMENT side tab .
2. Press **Reports**.
3. Insert a USB drive into the console.
4. Select the job to be saved.
5. Select:
  - ▶ PDF  – report for print
  - ▶ KML  – Google Earth Map
  - ▶ SHP  – ESRI shape data
  - ▶ ALL  – all available file types
6. Press RETURN arrow  or DATA MANAGEMENT side tab  to return to the main Data Management screen.





**NOTE:** The file icons     or buttons are not available for selection (grayed out) until a USB drive is inserted properly.

Figure 4-27: Reports – Advanced Job Mode



Figure 4-28: Reports – Simple Job Mode



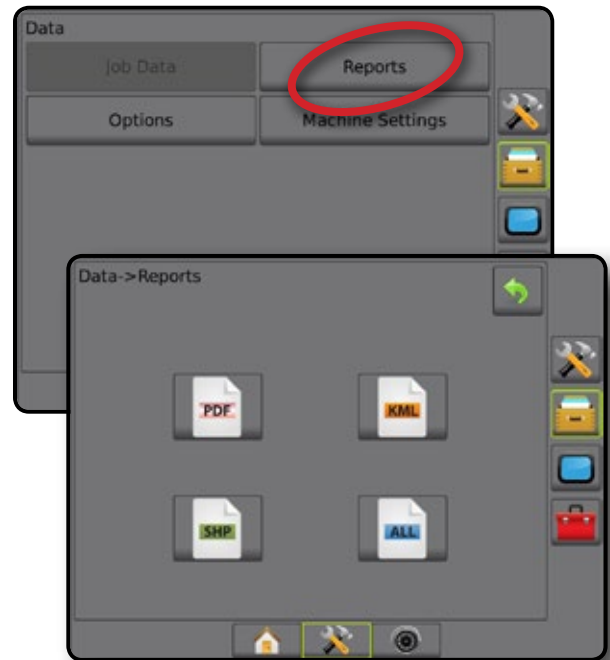

## Options (Job Mode)

Options allows the operator to select between Simple or Advanced Job Mode.

**NOTE:** When a job is active/started, changing the job mode is not available. Stop the current job to enable the function.

**WARNING!** Changing job modes deletes all internal job data.

1. Press DATA MANAGEMENT side tab .
2. Press **Options**.
3. Press DOWN arrow  to access the list of options.
4. Select:
  - ▶ Simple – only bounded area and coverage areas are displayed on the home screen. Only the current job is available for saving in Reports. Use with Fieldware Link is not available.
  - ▶ Advanced – more than one job will be available at any time. Client, farm, field and job names; bounded and coverage areas; application time; and distance from selected job are displayed on the home screen. All saved job profiles can be exported as a PDF, SHP or KML file to a USB drive using Data -> Reports.
    - Client information, farm information, field information, and prescription maps can only be inputted using Fieldware Link. A job name can only be edited using Fieldware Link.
    - A user can duplicate jobs for reuse of boundaries, guidelines, coverage data and prescription maps using Fieldware Link or Data -> Job Data -> Manage in the console.

5. "Changing job modes requires deleting all job data. Do you wish to change modes?"

Press:

- ▶ Yes – to make the change
- ▶ No – to keep the current setting



6. Press RETURN arrow  or DATA MANAGEMENT side tab  to return to the main Data Management screen.

Figure 4-29: Options – Change Job Mode



## Machine Settings

Machine Settings is used to transfer profiles for machine settings (delete, import, export) and manage profiles for machine settings (create a new profile, copy or delete a profile, save the current profile to the selected profile, or load the selected profile's machine settings).

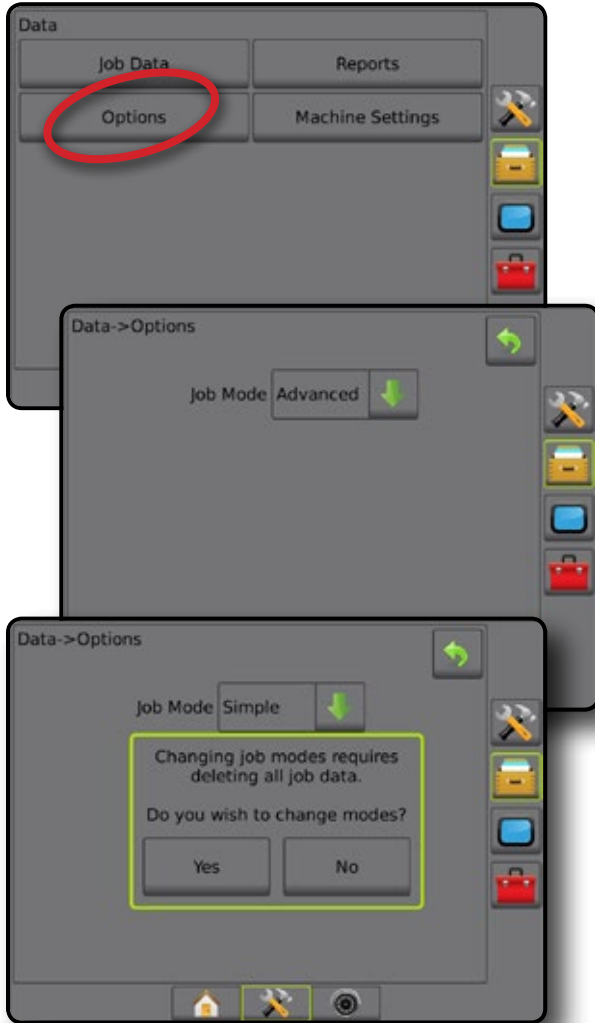
Machine Settings include:

- Implement settings
- AutoSteer/Tilt Correction settings
- Rate Control settings
- Job-specific settings (including application rates, application type, and Product Channel assignments)

*NOTE: Not all settings are saved as part of the machine settings. See the appendix "Matrix Pro GS Console Menu Settings" for details.*



1. Press DATA MANAGEMENT side tab .
2. Press **Machine Settings**.
3. Select from:
  - ▶ Transfer – allows the transfer of selected machine settings to or from a USB drive, as well as deleting machine settings
  - ▶ Manage – allows the creation of a new empty machine settings, the copying of a selected machine settings to a new machine settings, the deletion of a selected machine settings, the saving of the current machine settings to the selected machine settings, or the loading of the selected machine settings to the current settings
4. Press RETURN arrow  or DATA MANAGEMENT side tab  to return to the main Data Management screen.

Figure 4-30: Machine Settings



## Transfer

The machine settings transfer screen allows the transfer of selected machine settings to or from a USB drive, as well as deleting machine settings.

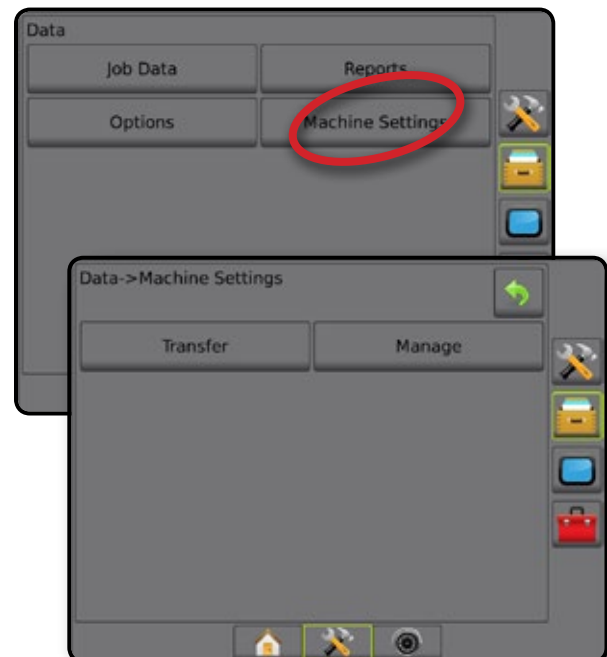
Machine settings transferred to a USB storage device can be opened and updated using Fieldware Link. From Fieldware Link, machine settings can be ported back to a USB storage device to be moved back onto the console internal storage for use.

*NOTE: Not all settings saved as part of the machine settings are available to be edited in Fieldware Link. See the setting availability chart for details.*

*Machine settings transferred to a storage device are removed from the console and are no longer available for use.*







1. Press DATA MANAGEMENT side tab .
2. Press **Machine Settings**.
3. Press **Transfer**.
4. Select from:
  - ▶ Move Machine Settings to USB Storage  – used to move machine settings from internal storage to USB
  - ▶ Move Machine Settings to Internal Storage  – used to move machine settings from USB to internal storage
  - ▶ Delete Machine Settings  – used to delete machine settings from internal storage or USB storage
5. Press RETURN arrow  or DATA MANAGEMENT side tab  to return to the main Data Management screen.

Figure 4-31: Machine Settings – Transfer



## Manage

The Machine Settings Manage screen allows the creation of a new empty machine settings, the copying of a selected machine settings to a new machine settings, the deletion of a selected machine settings, the saving of the current machine settings to the selected machine settings, or the loading of the selected machine settings to the current settings.

*NOTE: Not all settings are saved as part of the machine settings. See the appendix "Matrix Pro GS Console Menu Settings" for details.*



1. Press DATA MANAGEMENT side tab .
2. Press **Machine Settings**.
3. Press **Manage**.
4. Select from:
  - ▶ New – used to create a new machine setting with no associated implement information
  - ▶ Copy – used to copy a selected machine settings into a new machine settings
  - ▶ Delete – used to delete a selected machine settings from internal storage
  - ▶ Save – used to save the current machine settings to the selected machine settings
  - ▶ Load – used to load the selected machine settings to the current settings
5. Press RETURN arrow  or DATA MANAGEMENT side tab  to return to the main Data Management screen.

Figure 4-32: Machine Settings – Manage



## CONSOLE

Console Setup is used to configure the display and cultural settings, unlock advanced features, connect to wireless network, and play back demo GNSS data. Information about other devices attached to the system can be found in the About section.

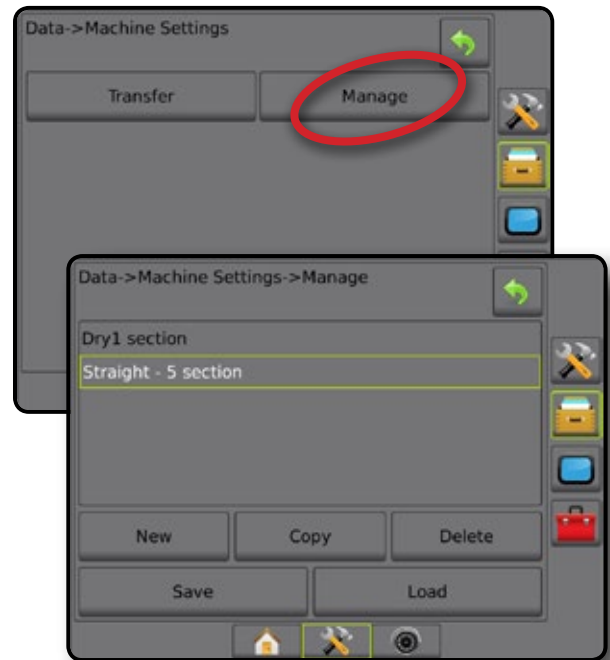

1. Press SYSTEM SETUP bottom tab .
2. Press CONSOLE side tab .
3. Select from:
  - ▶ About – used to display the system software version as well as the software versions of modules connected to the CAN bus
  - ▶ Display – used to configure color scheme and LCD brightness, establish screenshot availability, and calibrate the touchscreen
  - ▶ Cultural – used to configure units, language, and time zone settings
  - ▶ Audio Volume – used to adjust the volume level of the audio speaker
  - ▶ Demo GNSS – used to start playback of simulated GNSS data
  - ▶ Feature Unlock – used to unlock advanced features



Figure 4-33: Console Options

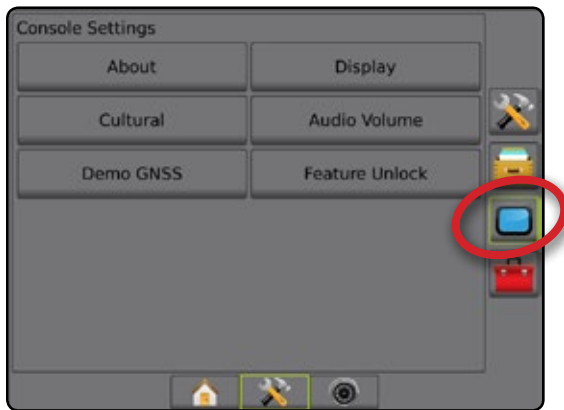

## About

About/Save screen displays the system software version as well as the software versions of modules connected to the CAN bus.

To aid when troubleshooting problems in the field, an end user can use the Save button to download a text file containing current software information to a USB drive, then e-mail the file to support personnel.

1. Press CONSOLE side tab .
2. Press **About**.
3. Select from:
  - ▶ View Information including Unit Serial Number, Software Version, and Connected Modules
  - ▶ With a USB drive in the console, press **Save** to save the About information to the USB drive. Saved version information to USB drive will confirm the save.
4. Press RETURN arrow  or CONSOLE side tab  to return to the main Console Settings screen.

*NOTE: The **Save** option is not available for selection (grayed out) until a USB drive is inserted properly.*

Figure 4-34: About Options

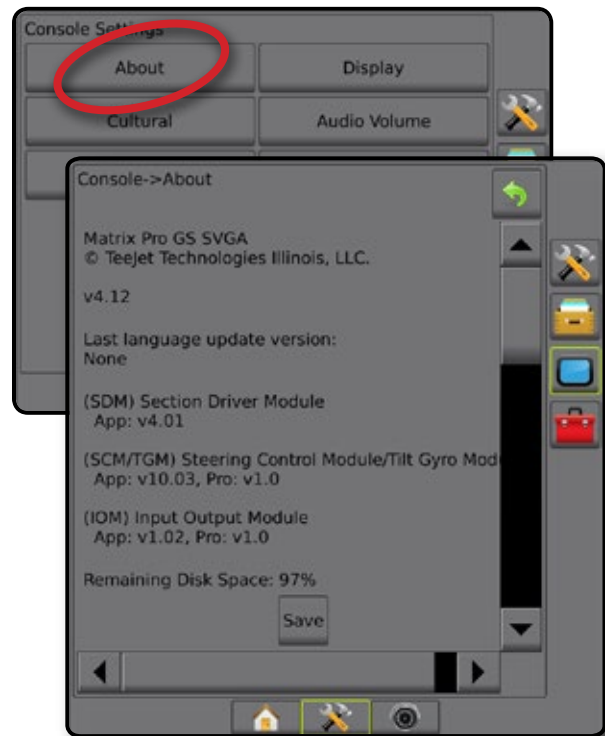

## Display

Display is used to configure color scheme and LCD brightness, establish screenshot availability and calibrate the touchscreen.



1. Press CONSOLE side tab .
2. Press **Display**.
3. Select from:
  - ▶ Color Scheme – used to choose the color scheme that is easiest to read
  - ▶ LCD Brightness – used to adjust the brightness of the console display
  - ▶ Screenshot – used to allow screen captures to be saved to a USB drive
  - ▶ Screen Calibration – used to calibrate the touch screen
4. Press RETURN arrow  or CONSOLE side tab  to return to the main Console Settings screen.

Figure 4-35: Display Options



## Cultural

Cultural is used to configure units, language, and time zone settings.



1. Press CONSOLE side tab .
2. Press **Cultural**.
3. Select from:
  - ▶ Units – used to define the system units
  - ▶ Language – used to define the system language
  - ▶ Time Zone – used to establish the local time zone
4. Press RETURN arrow  or CONSOLE side tab  to return to the main Console Settings screen.

Figure 4-36: Cultural Options



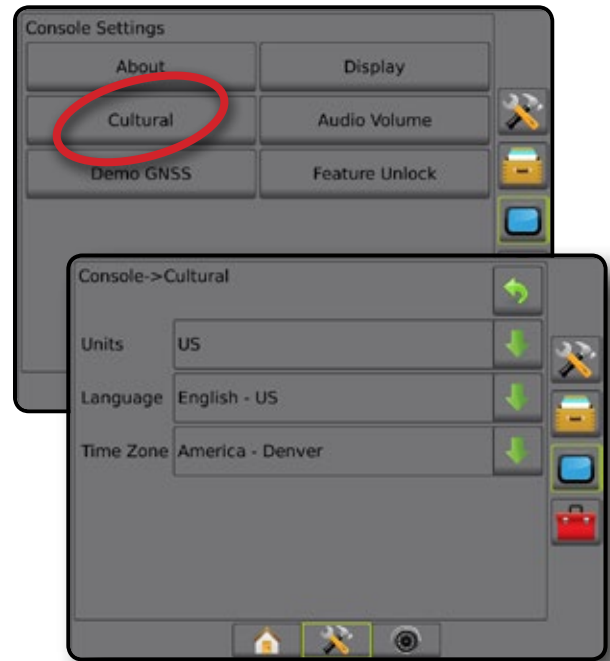

## Audio Volume

Audio Volume adjusts the volume level of the audio speaker.





1. Press CONSOLE side tab .
2. Press **Audio Volume**.
3. Press:
  - ▶ UP arrow  to increase the sound
  - ▶ DOWN arrow  to soften the sound
4. Press RETURN arrow  or CONSOLE side tab  to return to the main Console Settings screen.



Figure 4-37: Audio Volume Options



## Demo GNSS

Demo GNSS is used to start the playback of a simulated GNSS signal.

*WARNING! This tool will disable incoming GNSS positions and begin playing back simulated data. A console reboot is necessary in order to restore real GNSS.*

1. Press CONSOLE side tab .
2. Press **Demo GNSS**.
3. Press **Start**.
4. Press RETURN arrow  or CONSOLE side tab  to return to the main Console Settings screen.

*NOTE: A console reboot is necessary in order to restore a real GNSS.*

Figure 4-38: Demo GNSS



## Restart Demo GNSS

Demonstration GNSS can be restarted.



1. Press CONSOLE side tab .
2. Press **Demo GNSS**.
3. Press **Restart**.
4. Press RETURN arrow  or CONSOLE side tab  to return to the main Console Settings screen.

Figure 4-39: Restart Demo GNSS



## Feature Unlock

Feature Unlock is used to unlock advanced features.

*NOTE: The unlock code is unique for each console. Contact TeeJet Technologies Customer Service. Once unlocked, a feature remains unlocked unless the console is fully reset.*



1. Press CONSOLE side tab .
2. Press **Feature Unlock**.
3. Press the locked feature button  for the locked feature:
  - ▶ BoomPilot for Spreader – allows for spreader application options when used with a compatible spreader implement
  - ▶ FieldPilot Pro / UniPilot Pro – allows for AutoSteer options when using a SCM Pro
  - ▶ Third-Party Rate Control – allows for rate control options when used with a compatible third-party rate controller
4. Enter unlock code if required.
5. Restart the console.

Figure 4-40: Feature Unlocked



## TOOLS

Tools is used to upload software updates for system devices, and to do various calculations on a regular calculator or a unit converter.

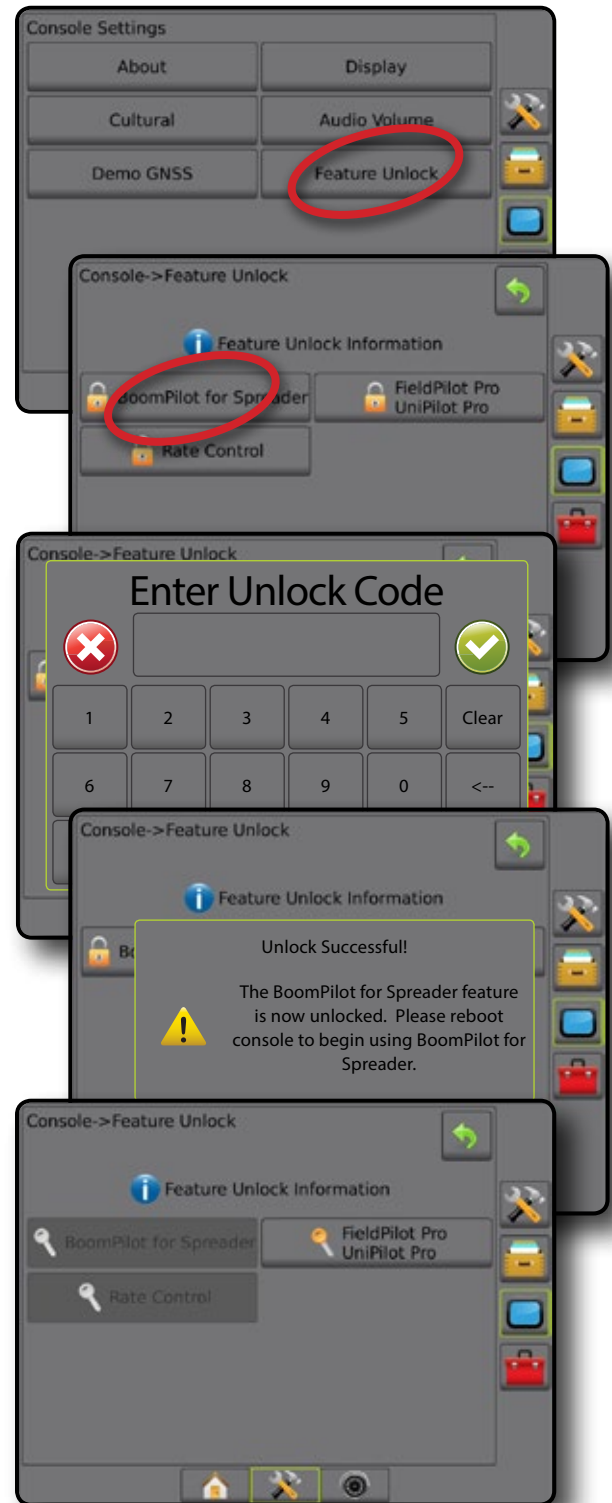

1. Press SYSTEM SETUP bottom tab .
2. Press TOOLS side tab .
3. Select from:
  - ▶ Upload Software – used to upload software updates from a USB drive for system devices.
  - ▶ Extras – accesses Calculator and Units Converter

Figure 4-41: Tools Options



## Upload Software

The Upload Software screen is used to upload software updates from a USB drive for system devices.

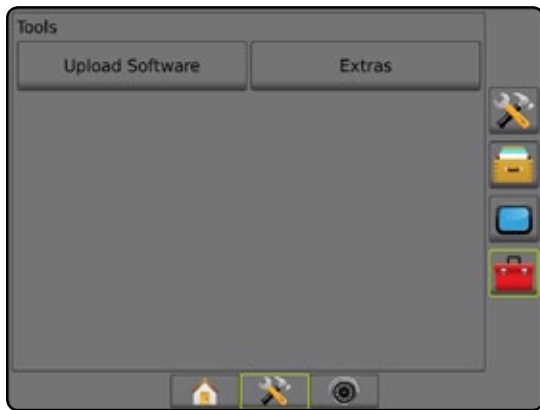
*NOTE: Availability of this feature will vary depending on software version.*





1. Press TOOLS side tab .
2. Press **Upload Software**.
3. Insert the USB drive containing software updates into the console.
4. Press Device DOWN arrow  and select the device for which software will be updated:
5. Press Software DOWN arrow  and select the software update to be uploaded to the device.
6. Press **Begin Upload**.
7. When prompted, press **OK**.
8. Press RETURN arrow  to return to the Tools screen, or press CONSOLE side tab  to return to the main Console Settings screen.

Figure 4-42: Upload Software



## Extras

1. Press TOOLS side tab .
2. Press **Extras**.
3. Select from:
  - ▶ Calculator – used to perform mathematical calculations
  - ▶ Units Converter – used to perform unit conversions for area, length, volume, pressure, mass, temperature, or angle

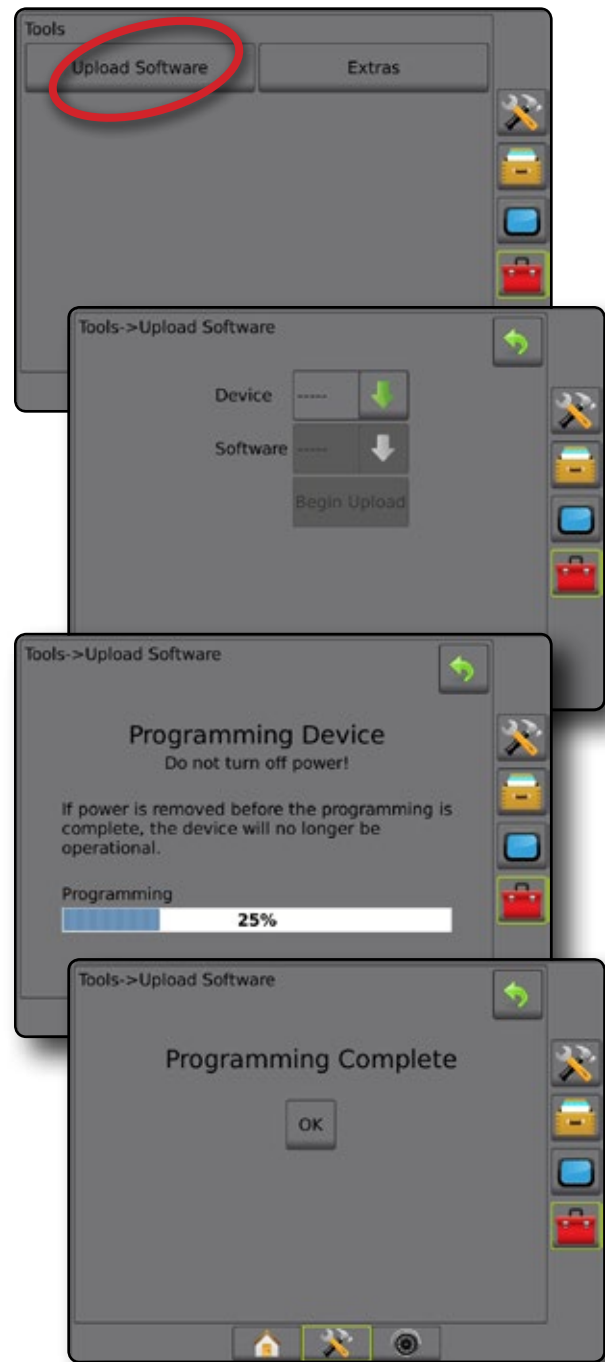
Figure 4-43: Calculator

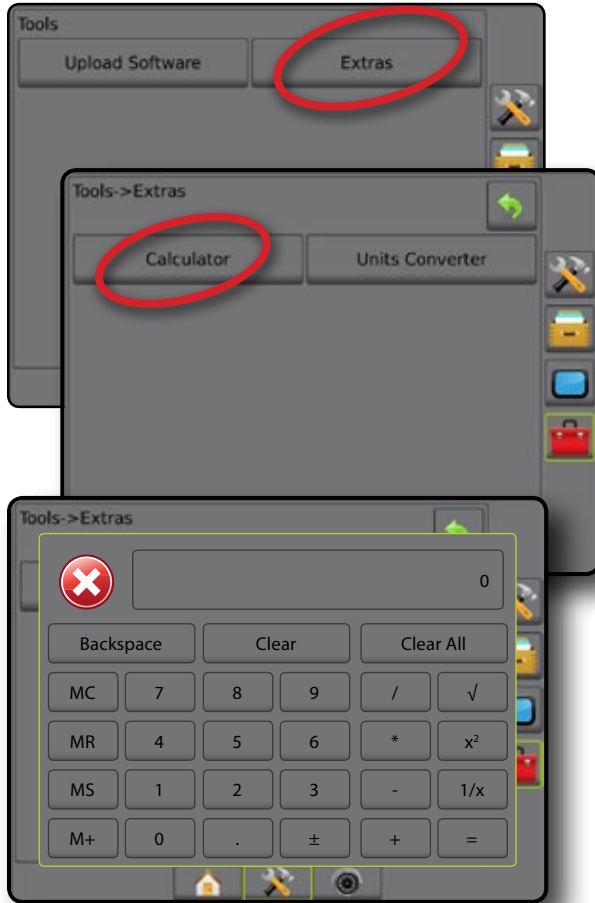
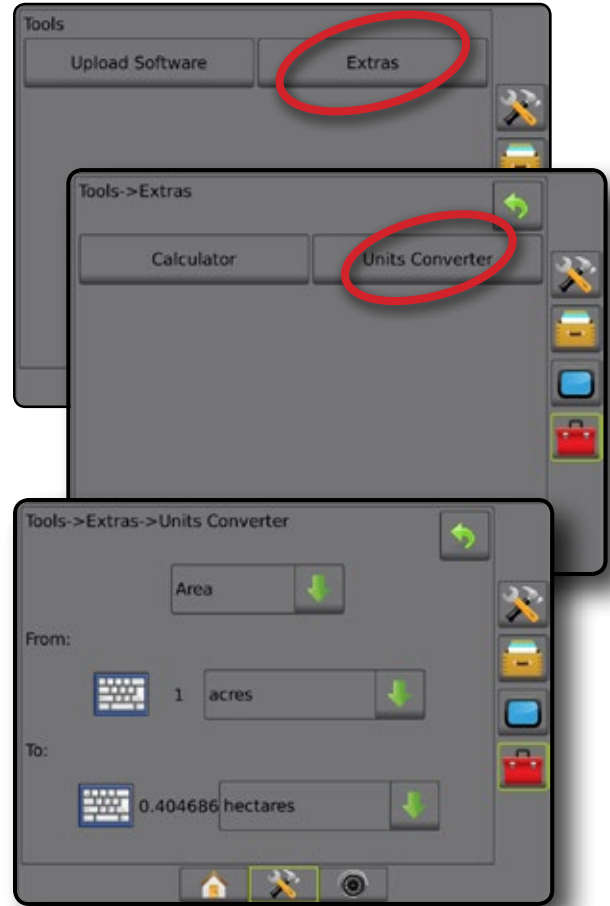

Figure 4-44: Units Converter



## CHAPTER 5 – GNSS RECEIVER CONFIGURATION

GNSS Receiver Configuration is used to configure GNSS Type, GNSS Port, and PRN, and other GNSS parameters, and to view GNSS status information.

### GNSS Receiver Configuration

*NOTE: These settings are required for rate control, assisted/ auto steering, and tilt sensor operation, as well as proper implement operation.*



1. Press CONFIGURATION side tab .
2. Press **GNSS Receiver Configuration**.
3. Select from:
  - ▶ GNSS Type – sets to accept GNSS source transmissions: GPS, GLONASS, or SBAS (with or without DGPS Required).
  - ▶ GNSS Port – sets GNSS communication port: Internal or External
  - ▶ GNSS Status Information – displays current Baud Rate, Baud Rate Status, GNSS Status Information: GGA/VTG (Data Rates), Number of Satellites, HDOP, PRN, GGA Quality, Receiver, Receiver Version, UTM Zone, and correction model
  - ▶ Program – allows direct programming of the GNSS receiver through a command line interface. Only TeeJet support technicians should use this feature. Use at your own risk!
  - ▶ PRN – selects the SBAS PRN that will provide GNSS differential correction data. Set to **Automatic** for automatic PRN selection.
  - ▶ Alternate PRN – when PRN is not automatic, a second alternate SBAS PRN will provide a second set of GNSS differential correction data
4. Press RETURN arrow  or CONFIGURATION side tab  to return to the main Configuration screen.

Figure 5-1: GNSS Options





## GNSS Type

In addition to GPS signals, GNSS Type can be customized to accept GNSS augmentation signals: differentially corrected SBAS source transmissions, uncorrected GLONASS source transmissions or both. DGPS source transmissions can also be required.



1. Press NEXT PAGE arrow  to access the list of options.
2. Select:
  - ▶ GPS – uncorrected signals from the GPS system  
*NOTE: GPS is always selected.*
  - ▶ GLONASS – adds uncorrected signals from the GLONASS system
  - ▶ SBAS (e.g. EGNOS, GAGAN, MSAS, SDCM, WAAS) – adds differentially corrected signals from the SBAS system
  - ▶ DGPS Required – adds differentially corrected GPS signals (SBAS must also be selected)  
*NOTE: The console will not allow guidance in DGPS Required mode without the corrected DGPS signal.*
3. Exit this screen to begin initializing the GNSS receiver. This takes about a minute, and the console will not respond until complete.

Figure 5-2: GNSS Type

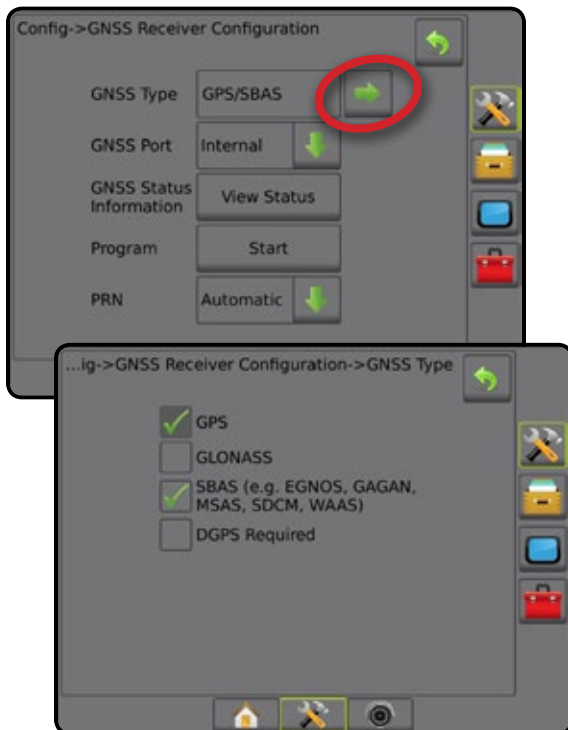

## GNSS Port

The COM port can be set to “Internal” to use the internal GNSS receiver and transmit out, or “External” to receive external GNSS data.

1. Press DOWN arrow  to access the list of options.
2. Select:
  - ▶ Internal – use the internal GNSS and transmit out
  - ▶ External – receive external GNSS data

*NOTE: Working with signals such as OmniSTAR HP/XP or RTK will require GNSS Port to be set to External.*

Figure 5-3: GNSS Port



**External Receiver Minimum Configuration Requirements**  
Before the Matrix Pro GS will connect and work with an external GNSS receiver, these minimum configuration requirements must be met.

### Serial Port Settings

Baud rate:	not allowed below 38,400
Recommended	38,400, 56,000, 57,600, 76,800, or 115,200
FieldPilot Pro / UniPilot Pro	115,200
Data Bits:	8
Parity:	None
Stop Bits:	1

### Serial Port connection requirements

Male 9-pin RS-232 serial cable

*NOTE: May require Null modem adapter depending on pin-out of receiver.*

### NMEA Strings

GGA	10.0 Hz
Optional VTG	10.0 Hz
ZDA	1.0 Hz

## GNSS Status Information

GNSS Status Information displays a snapshot of the current GNSS status information.

1. Press **View Status**.
2. View data including:
  - ◀ Baud Rate – the current status of the GNSS
  - ◀ Baud Rate Status – the rate at which information is transferred/ communicated.
 

*NOTE: a minimal baud rate maybe required for some software version to work at their peak performance.*
  - ◀ GGA/VTG Data Rates – the number of GNSS positions per second.
  - ◀ Number of Satellites – the number of GNSS satellites in view (minimum of 4 are required for DGPS)
  - ◀ HDOP – a measure of satellite geometry strength in the horizontal plane. A HDOP value of less than 2 is preferred.
  - ◀ PRN – the current DGPS satellite ID
  - ◀ GGA Quality – the current quality indicator of the GNSS signal (see GGA Requirements chart)
  - ◀ Receiver – the current indicator of the receiver
  - ◀ Receiver Version – the software version installed on the receiver
  - ◀ UTM Zone – zone where currently located (see "UTM Coordinates and Zones" in this manual)
  - ◀ Model – the correction models available to be used with the current receiver configuration
3. Press **OK** to return to the GNSS Receiver Configuration screen.

*NOTE: If GNSS is not available, all entries will be "Invalid".*

Figure 5-4: GNSS Status Information



## GNSS Status Information on Guidance Screens

GNSS Status displays information regarding current GNSS status, including data rates, number of satellites in view, HDOP and PRN status, receiver and version, satellite quality and ID, and UTM zone.

1. Press GNSS STATUS icon

Figure 5-5: Guidance Screen GNSS Status Information

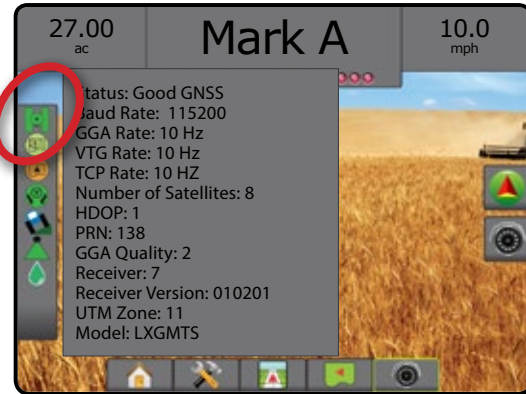

## GGA Requirements

GGA Quality required to be able to work with various types of signal can vary. See table below for requirements.

Service	Indicator	Accuracy
GPS only	1	<3 m
WAAS/EGNOS/Beacon	2	<1 m
RTK	4	4 cm
OmniSTAR HP/XP	5	10 cm
Glide/ClearPath	9	<1 m

## Program

Program allows direct programming of the GNSS receiver through a command line interface. Only TeeJet support technicians should use this feature. Use at your own risk!

1. Press **Start**.
2. Adjust programming as required.

Figure 5-6: Programming Receiver

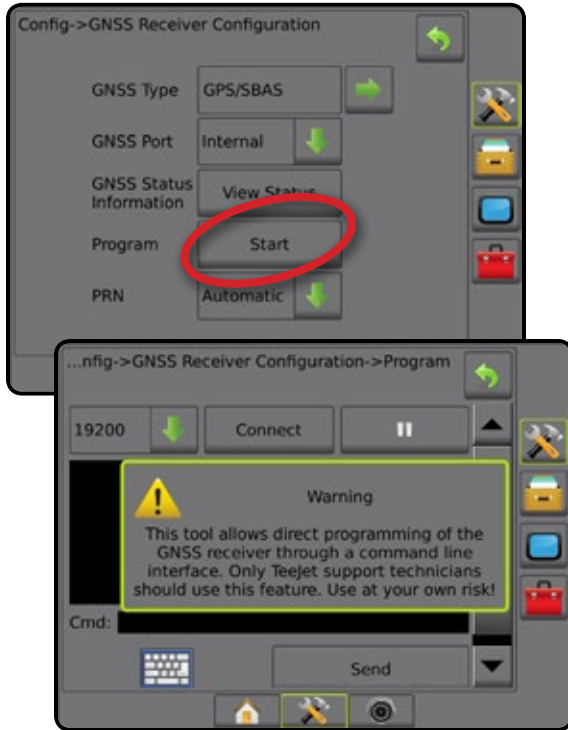

## PRN

PRN selects the SBAS PRN that will provide GNSS differential correction data.

1. Press DOWN arrow ↓ to access the list of options.
2. Select:
  - ▶ Automatic – automatic PRN selection
  - ▶ Number – contact your local dealer for the number associated with your operating location

Figure 5-7: PRN

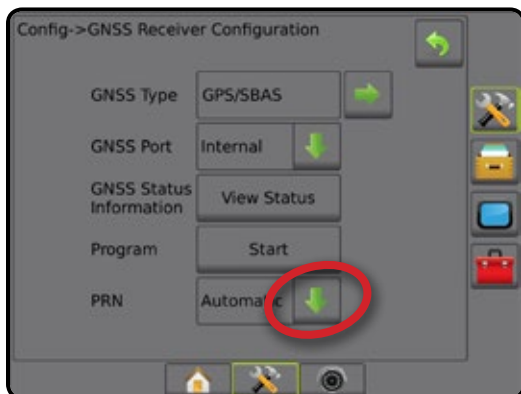

## Alternate PRN

When PRN is not automatic, a second alternate SBAS PRN will provide a second set of GNSS differential correction data.

1. Press DOWN arrow ↓ to access the list of options.
2. Select:
  - ▶ None – no alternate PRN number
  - ▶ Number – contact your local dealer for the number associated with your operating location

Figure 5-8: Alternate PRN

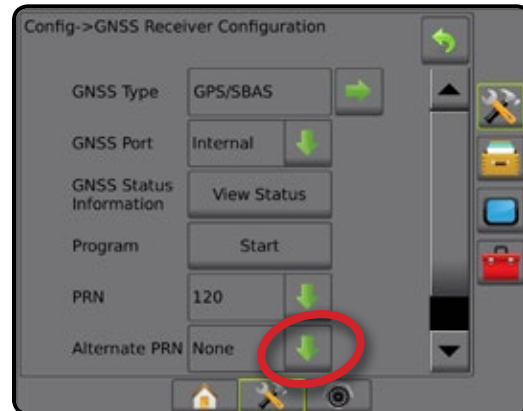

## PRN Not Shown

PRN options are only available with SBAS GNSS Type selected.

Figure 5-9: PRN Not Shown



## GNSS Glossary

### Commercial Satellite Provider:

Another common source for DGPS signals. Error correction information obtained from their base stations is sent to a communications satellite (separate from the GPS satellites) and broadcast to the user. These satellite-based corrections tend to have more widespread coverage than tower-based broadcasts (FM links), and system accuracy is not greatly affected by the user's distance from the base station receivers. Most of these service providers require a subscription fee for use. A commonly known provider is OmniSTAR®.

### CORS (Continuously Operating Reference Station)/ Network RTK:

A series of base stations spread across a given geographic region (such as an entire state/county) that are networked via a centralized computer and which broadcast RTK correction data over the Internet. CORS networks may be publicly or privately owned/operated and may offer a free signal or require an annual subscription fee. By accessing a CORS network via a cellular connection, the end-user eliminates the need to own a base station.

### Differential GPS (DGPS):

The most common way to correct for normally occurring GPS errors. Examples of DGPS include WAAS, EGNOS, OmniSTAR® and RTK.

### EGNOS (European Geostationary Navigation Overlay Service):

A satellite based augmentation system (SBAS) developed jointly by the European Space Agency (ESA), European Community and EUROCONTROL. The system is free to use and provides differential correction coverage primarily across the European continent. EGNOS delivers pass-to-pass accuracies of 6-10 in/15-25 cm and year-to-year accuracies of +/-3 ft/1 m.

### GLONASS (Global Navigation Satellite System):

A global satellite navigation system developed and operated by the Russian government. It is composed of approximately 24 satellites which continuously orbit the earth. While early GNSS receivers typically utilized only GPS signals, many of today's GNSS receivers can utilize signals from both GPS and GLONASS, effectively increasing the total number of satellites available for use.

### GPS (Global Positioning System):

The name of the satellite-navigation network maintained by the U.S. Department of Defense. It is composed of approximately 30 satellites which continuously orbit the earth. The term is also used to refer to any device that depends on navigation satellites for functionality.

### NTRIP (Networked Transportation of RTCM via Internet Protocol):

An internet-based application that makes the RTCM correction data from the CORS stations available to anyone with an internet connection and the appropriate log-on credentials to the NTRIP server. Typically uses a cellular link to get to the internet and the NTRIP server.

### GPS Drift:

Positional shift that can be caused by changes in satellite constellation, operating near trees or other obstacles and satellite clock errors. RTK correction is recommended for field applications where the effects of GPS drift need to be minimized.

### GNSS (Global Navigation Satellite System):

A general term that refers to a multiple satellite navigation system used by a receiver to compute its position. Examples of these systems include: GPS developed by the United States and GLONASS by Russia. Additional systems in development include Galileo by the European Union and Compass by China. New generation GNSS receivers are being designed to utilize multiple GNSS signals (such as GPS and GLONASS). Depending on constellation and desired accuracy levels, system performance may be improved by having access to a greater number of satellites.

### RTK (Real Time Kinematic):

Currently the most accurate GPS correction system available that uses a land-based reference station located in relatively close proximity to the GPS receiver. RTK can provide one-inch, also known as centimeter, pass-to-pass accuracy and also provides year-to-year position stability. RTK users can have their own base stations, subscribe to RTK Networks or use CORS.

### SBAS (Satellite Based Augmentation System):

A general term that refers to any satellite-based differential correction system. Examples of SBAS include: WAAS in the United States, EGNOS in Europe and MSAS in Japan. Additional SBAS covering other regions of the world will likely be coming online in the future.

### WAAS (Wide-Area Augmentation System):

A satellite correction service developed by the Federal Aviation Administration (FAA). It is free to use and provides coverage across the U.S. along with parts of Canada and Mexico. WAAS delivers pass-to-pass accuracies of 6-10 in/15-25 cm; however, year-to-year accuracy will be in the range of +/- 3 ft /1 m.

## CHAPTER 6 – IMPLEMENT SETUP

Implement Setup is used to establish the various settings associated with straight mode, spreader mode, and staggered mode.

Settings will vary depending on if there is section control available: SmartCable, Section Driver Module (SDM), or Switch Function Module (SFM).

### IMPLEMENT TYPE

Implement Type selects the type of application pattern that most closely represents your system.

- In Straight Mode – the boom sections have no length and are on a line a fixed distance from the antenna
- In Spreader Mode – a virtual line is created in line with the delivery disks from which the application section or sections can vary in length and can be at different distances from the line (availability depends on the specific equipment in the system)
- In Staggered Mode – a virtual line is created in line with Section 1 from which the application section or sections have no length and can be at different distances from the antenna (availability depends on the specific equipment in the system)

Figure 6-1: Implement Type – Straight

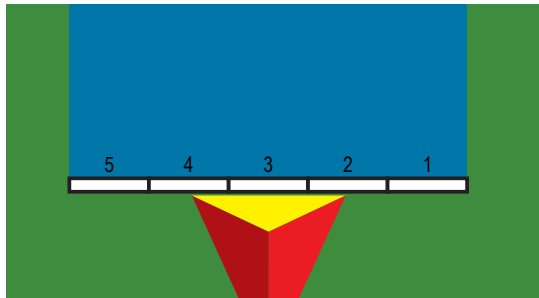

Figure 6-2: Implement Type – Spreader

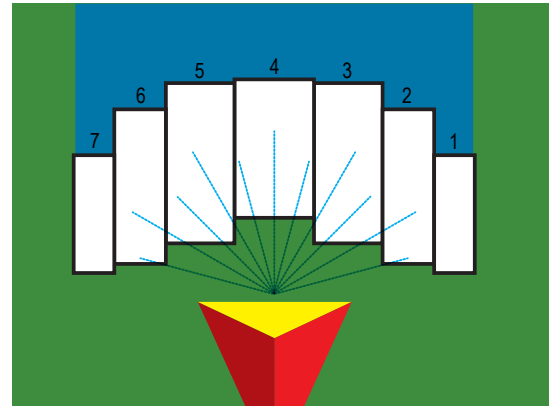
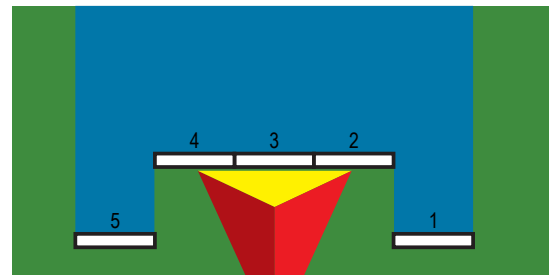

Figure 6-3: Implement Type – Staggered



### Section Numbers

Sections are numbered from left to right while facing in the machine's forward direction.



## Straight

The boom sections have no length and are on a line a fixed distance from the antenna.

### Single Section

No section control is available on the system.



1. Select **Straight** implement type on Implement screen.
2. Press Implement Type NEXT PAGE arrow .
3. Select from:
  - ▶ In-line Implement Offset Direction ① – used to select whether the implement is located in front of or behind the GNSS antenna as the vehicle moves in a forward direction
  - ▶ In-line Implement Offset Distance ① – used to define the in-line distance from the GNSS antenna to the implement.
  - ▶ Lateral Implement Offset Direction ② – used to select the lateral direction from the center line of the machine to the center of the implement while facing in the machine's forward direction
  - ▶ Lateral Implement Offset Distance ② – used to define the lateral distance from the center line of the machine to the center of the implement
4. Press RETURN arrow  to return to the Implement screen or CONFIGURATION side tab  to return to the main Configuration screen.

Figure 6-4: Single Section

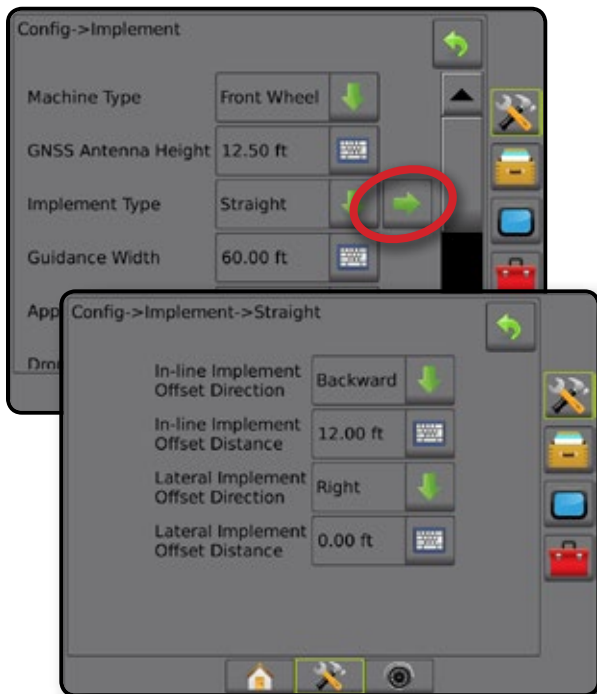
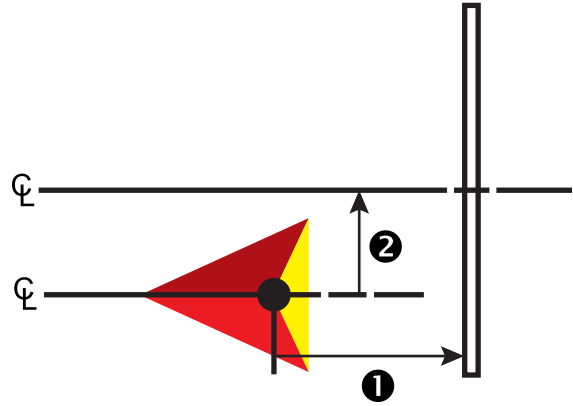

Figure 6-5: Offset Directions and Distances



### Multiple Sections

Section control is available (SmartCable, Section Driver Module (SDM), or Switch Function Module (SFM) or ISOBUS).



1. Select **Straight** implement type on Implement screen.
2. Press Implement Type NEXT PAGE arrow .
3. Select from:
  - ▶ In-line Implement Offset Direction ① – used to select whether the implement is located in front of or behind the GNSS antenna as the vehicle moves in a forward direction
  - ▶ In-line Implement Offset Distance ① – used to define the in-line distance from the GNSS antenna to the implement.
  - ▶ Lateral Implement Offset Direction ② – used to select the lateral direction from the center line of the machine to the center of the implement while facing in the machine's forward direction
  - ▶ Lateral Implement Offset Distance ② – used to define the lateral distance from the center line of the machine to the center of the implement
  - ▶ Overlap – used to define the amount of overlap allowed when using automatic boom section control
  - ▶ Delay On Time – used to set the time when the section will switch on when entering an area that has not been applied  
*NOTE: If the application turns on too soon when entering an unapplied area, decrease the Delay On time. If the application turns on too late, increase the Delay On time.*
  - ▶ Delay Off Time – used to set the time when the section will switch off when entering an area that has been applied  
*NOTE: If the application turns off too soon when entering an unapplied area, decrease the Delay Off time. If the application turns off too late, increase the Delay Off time.*
4. Press RETURN arrow  to return to the Implement screen or CONFIGURATION side tab  to return to the main Configuration screen.

Figure 6-6: Multiple Sections

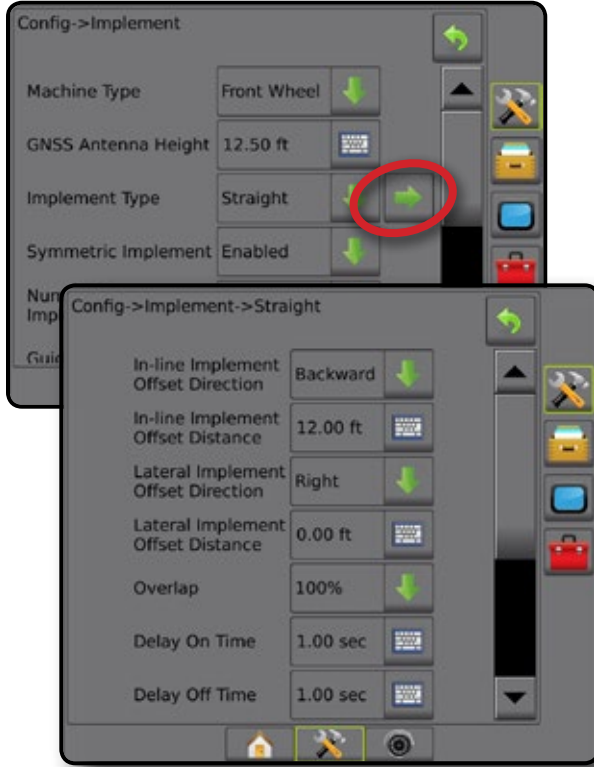

Figure 6-8: Overlap

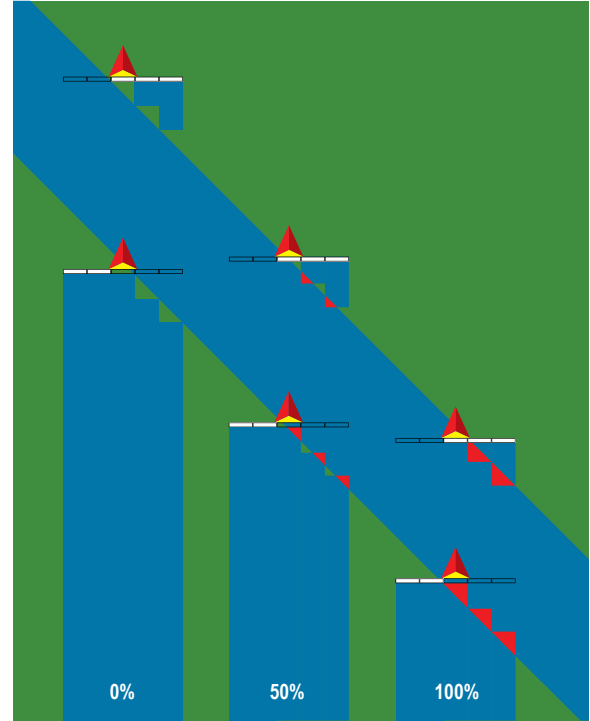
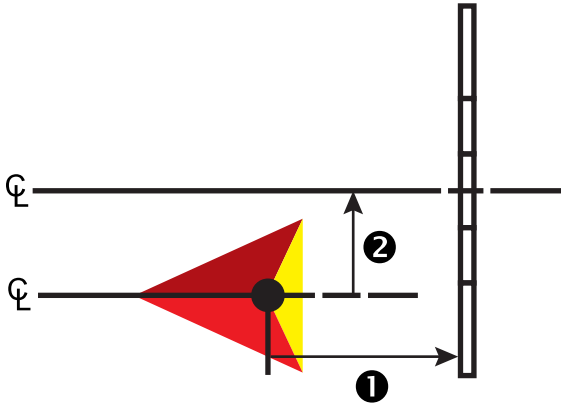

Figure 6-7: Offset Directions and Distances



## Spreader – TeeJet

A virtual line is created in line with the delivery disks from which the application section or sections can vary in length and can be at different distances from the line (availability depends on the specific equipment in the system).

### Single Section

No section control is available on the system.

1. Select **Spreader** implement type on Implement screen.
2. Press Implement Type NEXT PAGE arrow →.
3. Select from:
  - ▶ Setup Type – used to select **TeeJet** spreader type
  - ▶ Antenna to Disks Distance ❶ – used to define the distance from the GNSS antenna to the disks or dispersal mechanism
  - ▶ Lateral Implement Offset Direction ❷ – used to select the lateral direction from the center line of the machine to the center of the implement while facing in the machine's forward direction
  - ▶ Lateral Implement Offset Distance ❷ – used to define the lateral distance from the center line of the machine to the center of the implement
  - ▶ Spread Offset Distance ❸ – used to set the distance between the disks or dispersal mechanism and where product initially hits the ground for the section
  - ▶ Spread Length ❹ – used to set the length of application for the section



4. Press RETURN arrow  to return to the Implement screen or CONFIGURATION side tab  to return to the main Configuration screen.

Figure 6-9: Single Section

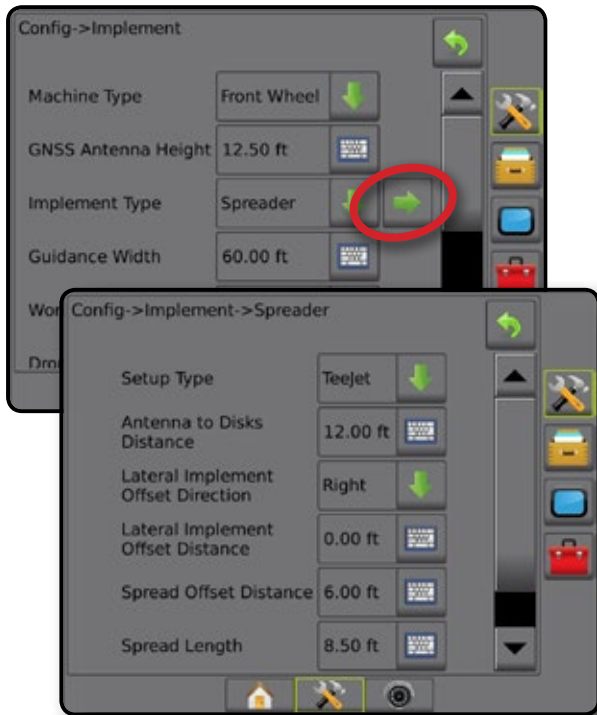

Figure 6-10: Distances and Length

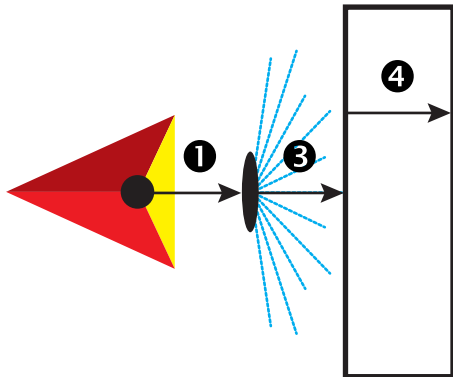
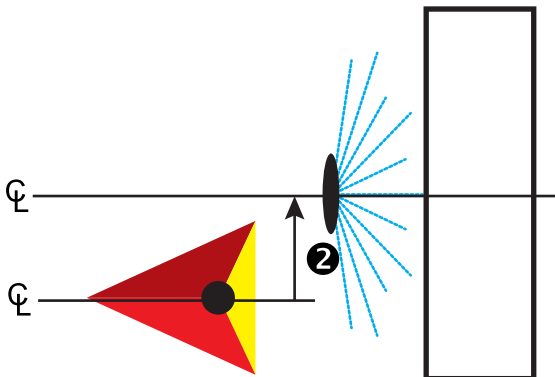

Figure 6-11: Lateral Offset Direction and Distance



## Multiple Sections

Section control is available (SmartCable, Section Driver Module (SDM), or Switch Function Module (SFM) or ISOBUS).



1. Select **Spreader** implement type on Implement screen.
2. Press Implement Type NEXT PAGE arrow .
3. Select from:
  - ▶ Setup Type – used to select **TeeJet** spreader type
  - ▶ Antenna to Disks Distance **1** – used to define the distance from the GNSS antenna to the disks or dispersal mechanism
  - ▶ Lateral Implement Offset Direction **2** – used to select the lateral direction from the center line of the machine to the center of the implement while facing in the machine's forward direction
  - ▶ Lateral Implement Offset Distance **2** – used to define the lateral distance from the center line of the machine to the center of the implement
  - ▶ Overlap – used to define the amount of overlap allowed when using automatic boom section control
  - ▶ Delay On Time – used to set the time when the section will switch on when entering an area that has not been applied  
*NOTE: If the application turns on too soon when entering an unapplied area, decrease the Delay On time. If the application turns on too late, increase the Delay On time.*
  - ▶ Delay Off Time – used to set the time when the section will switch off when entering an area that has been applied  
*NOTE: If the application turns off too soon when entering an unapplied area, decrease the Delay Off time. If the application turns off too late, increase the Delay Off time.*
  - ▶ Spread Offset Distance **3** – used to set the distance between the disks or dispersal mechanism and where product initially hits the ground on Section 1.
  - ▶ Section Offsets **4** – used to set the offset distance from Section 1 (the Spread Offset line) to the leading edge of each section. Section 1 is always 0. All other sections can be different distances.
  - ▶ Section Lengths **5** – used to set the length of application in each section. Each section can be a different length.  
*NOTE: Sections are numbered from left to right while facing in the machine's forward direction.*
4. Press RETURN arrow  to return to the Implement screen or CONFIGURATION side tab  to return to the main Configuration screen.

Figure 6-12: Multiple Sections

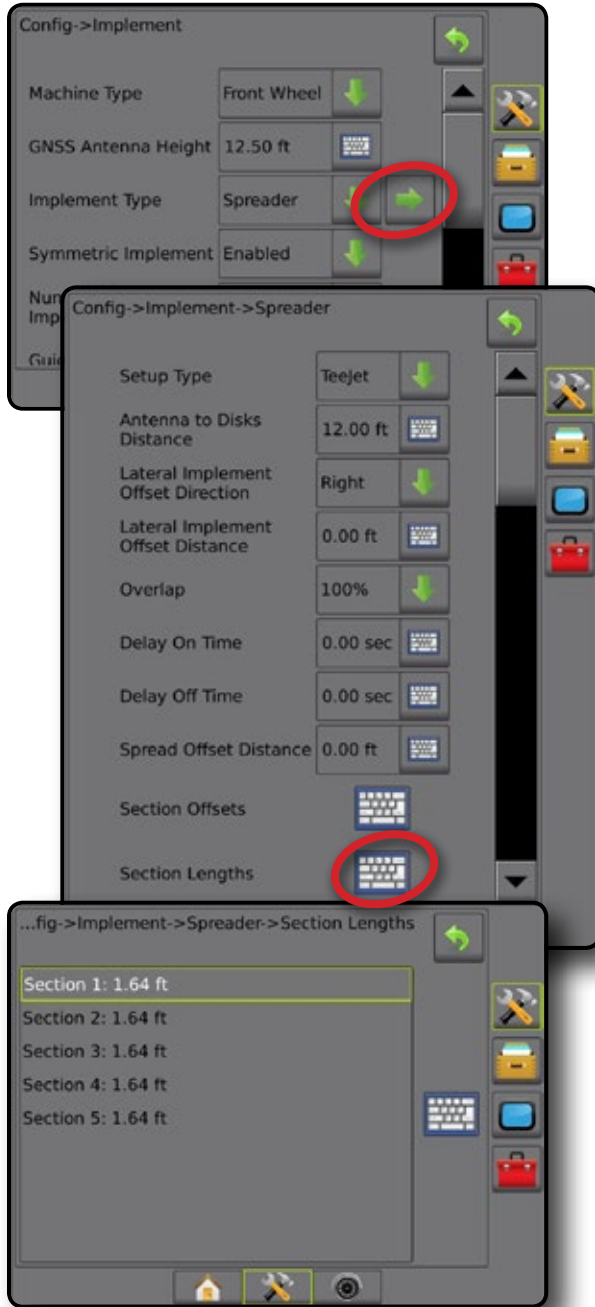

Figure 6-13: Distances and Length

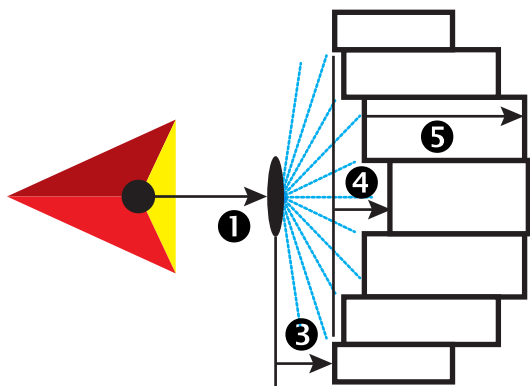

Figure 6-14: Lateral Offset Direction and Distance

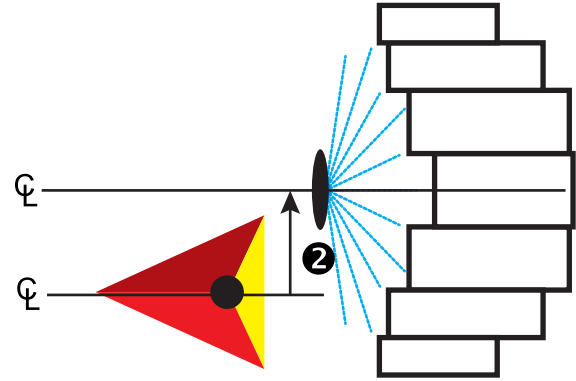
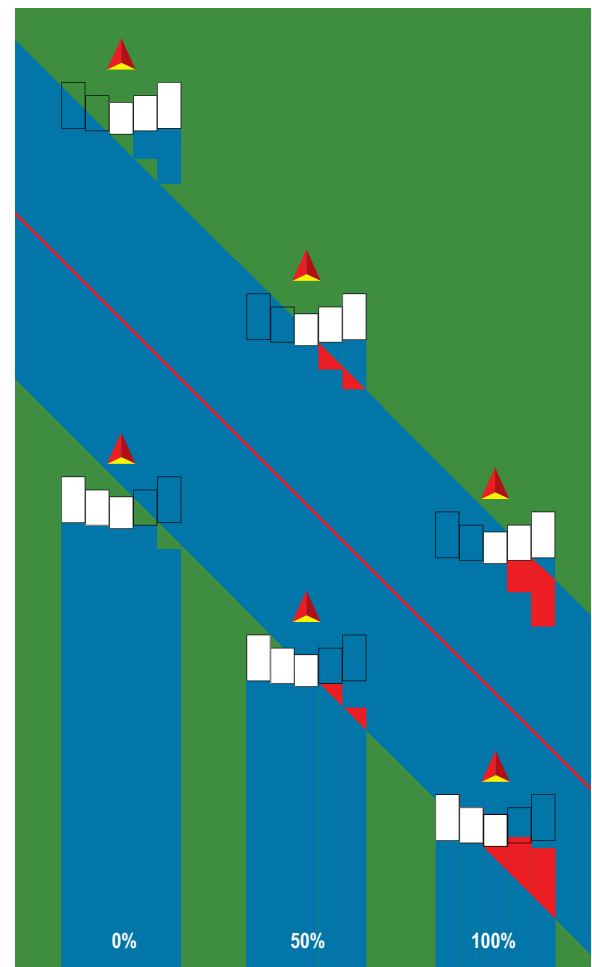

Figure 6-15: Overlap



## Spreader – OEM

A virtual line is created in line with the delivery disks from which the application section or sections can vary in length and can be at different distances from the line.

### Single Section

No section control is available on the system.

1. Select **Spreader** implement type on Implement screen.
2. Press Implement Type NEXT PAGE arrow →.
3. Select from:
  - ▶ Setup Type – used to select **OEM** spreader type
  - ▶ Antenna to Disks Distance – used to define the distance from the GNSS antenna to the disks or dispersal mechanism
  - ▶ Lateral Implement Offset Direction – used to select the lateral direction from the center line of the machine to the center of the implement while facing in the machine's forward direction
  - ▶ Lateral Implement Offset Distance – used to define the lateral distance from the center line of the machine to the center of the implement
  - ▶ Start Distance – used to set the start distance when exiting an applied area (consult spreader manufacturer for value)
  - ▶ Stop Distance – used to set the stop distance when entering an applied area (consult spreader manufacturer for value)

*NOTE: Consult spreader manufacturer for start and stop distances.*
4. Press RETURN arrow ↩ to return to the Implement screen or CONFIGURATION side tab 🛠 to return to the main Configuration screen.

Figure 6-16: Single Section

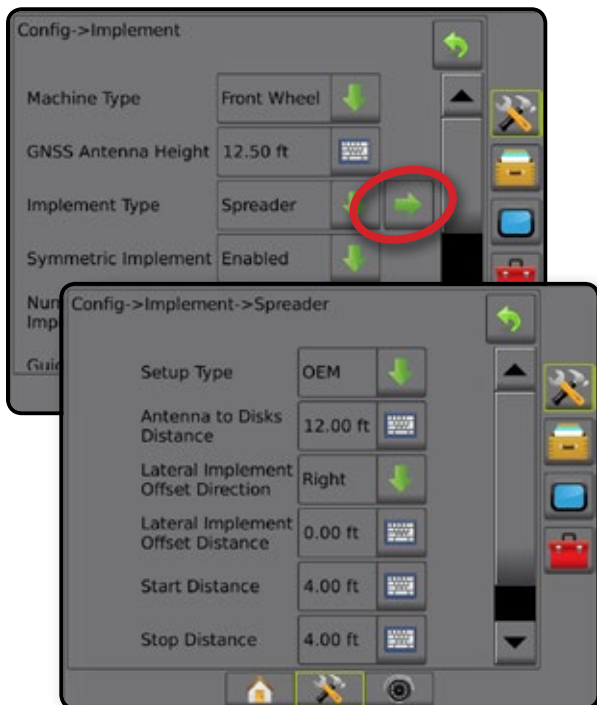

## Multiple Sections

Section control is available (SmartCable, Section Driver Module (SDM), or Switch Function Module (SFM) or ISOBUS).

1. Select **Spreader** implement type on Implement screen.
2. Press Implement Type NEXT PAGE arrow →.
3. Select from:
  - ▶ Setup Type – used to select **OEM** spreader type
  - ▶ Antenna to Disks Distance – used to define the distance from the GNSS antenna to the disks or dispersal mechanism
  - ▶ Lateral Implement Offset Direction – used to select the lateral direction from the center line of the machine to the center of the implement while facing in the machine's forward direction
  - ▶ Lateral Implement Offset Distance – used to define the lateral distance from the center line of the machine to the center of the implement
  - ▶ Start Distance – used to set the start distance when exiting an applied area (consult spreader manufacturer for value)
  - ▶ Stop Distance – used to set the stop distance when entering an applied area (consult spreader manufacturer for value)

*NOTE: Consult spreader manufacturer for start and stop distances.*

  - ▶ Section Start Offsets – used to set the offset distance from Section 1 to the leading edge of each section. Section 1 is always 0. All other sections can be different distances.
  - ▶ Section Stop Offsets – used to set the offset distance from Section 1 to the trailing edge of each section. Each section can be a different distance.

*NOTE: Consult spreader manufacturer for section start and stop offset values. Sections are numbered from left to right while facing in the machine's forward direction.*
4. Press RETURN arrow ↩ to return to the Implement screen or CONFIGURATION side tab 🛠 to return to the main Configuration screen.



Figure 6-17: Multiple Sections

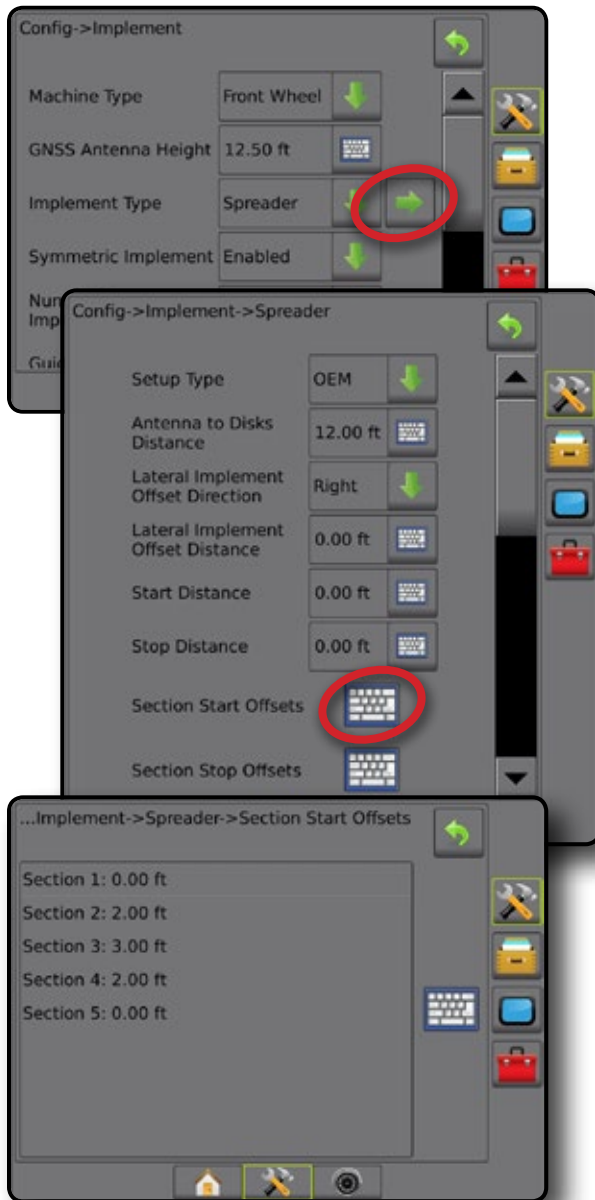

## Staggered

A virtual line is created in line with Section 1 from which the application section or sections have no length and can be at different distances from the antenna.

## Multiple Sections

Section control is available (SmartCable, Section Driver Module (SDM), or Switch Function Module (SFM) or ISOBUS).

1. Select **Staggered** implement type on Implement screen.
2. Press Implement Type NEXT PAGE arrow →.
3. Select from:
  - ▶ In-line Section 1 Offset Direction ❶ – used to select whether Section 1 (the zero-point of the Section Offsets) is located in front of or behind the GNSS antenna as the vehicle moves in a forward direction
  - ▶ In-line Section 1 Offset Distance ❶ – used to define the in-line distance from the GNSS antenna to Section 1 (the zero-point of the Section Offsets)
  - ▶ Lateral Implement Offset Direction ❷ – used to select the lateral direction from the center line of the machine to the center of the implement while facing in the machine's forward direction
  - ▶ Lateral Implement Offset Distance ❷ – used to define the lateral distance from the center line of the machine to the center of the implement
  - ▶ Overlap – used to define the amount of overlap allowed when using automatic boom section control
  - ▶ Delay On Time – used to set the time when the section will switch on when entering an area that has not been applied  
*NOTE: If the application turns on too soon when entering an unapplied area, decrease the Delay On time. If the application turns on too late, increase the Delay On time.*
  - ▶ Delay Off Time – used to set the time when the section will switch off when entering an area that has been applied  
*NOTE: If the application turns off too soon when entering an unapplied area, decrease the Delay Off time. If the application turns off too late, increase the Delay Off time.*
  - ▶ Section Offsets ❸ – used to set the offset distance from Section 1 (the In-Line Section 1 Offset Distance line) to each section. A positive offset value will move the section behind Section 1. A negative offset value will move the section in front of Section 1. Section 1 is always 0. All other sections can be different distances.
4. Press RETURN arrow ↶ to return to the Implement screen or CONFIGURATION side tab 🛠️ to return to the main Configuration screen.

# Matrix® Pro 570GS • Matrix® Pro 840GS

INTRODUCTION

HOME

FULL SCREEN

SETUP

GNSS

IMPLEMENT

GUIDANCE

RATE CONTROL

APPENDIX

Figure 6-18: Multiple Sections

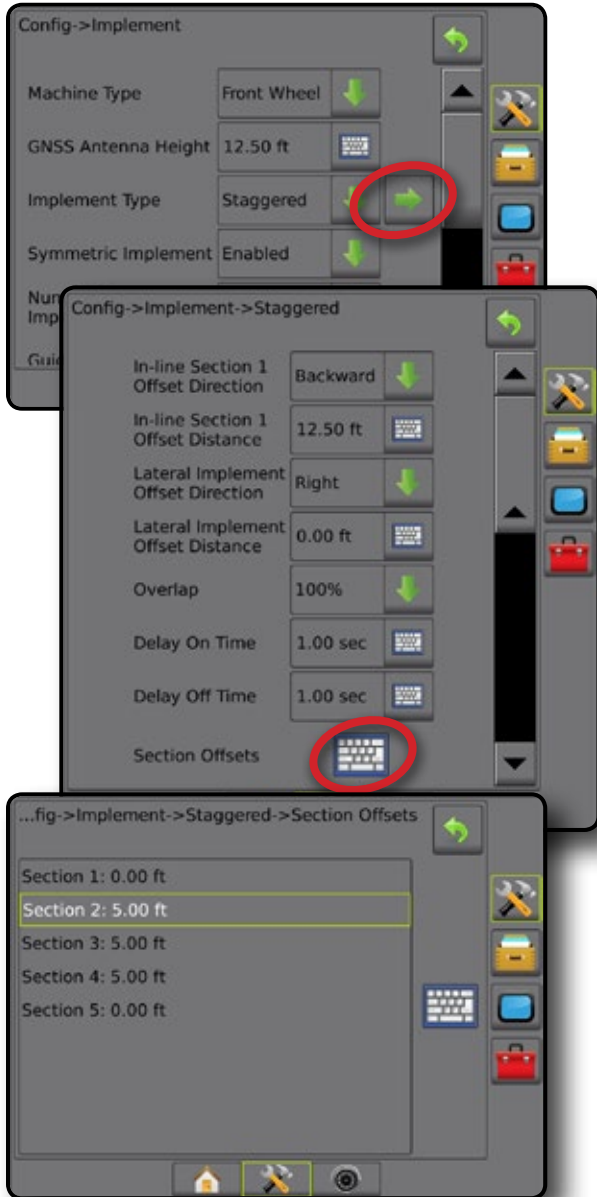

Figure 6-19: Offset Directions and Distances – behind section 1

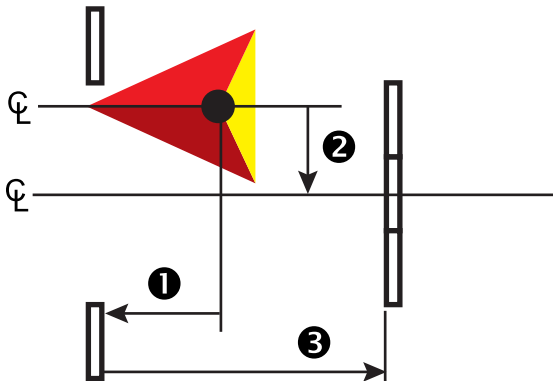

Figure 6-20: Offset Directions and Distances – in front of section 1

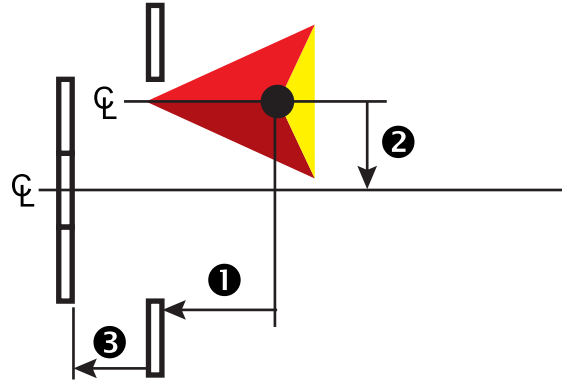
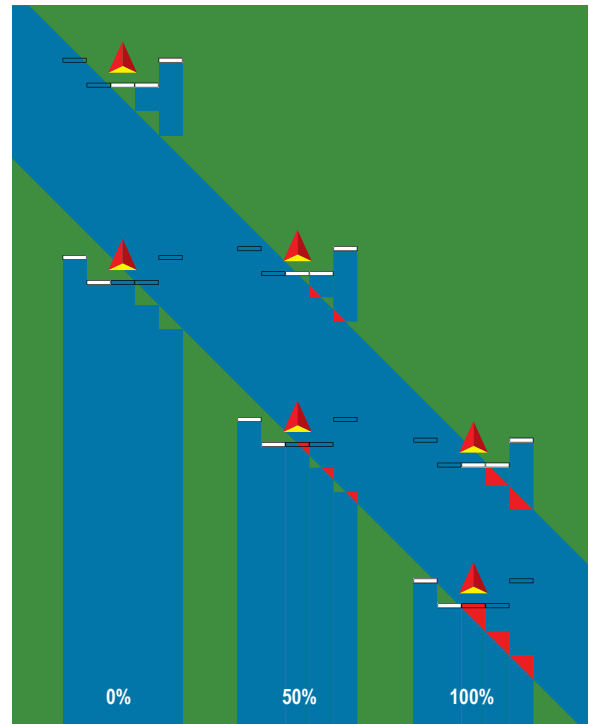

Figure 6-21: Overlap



## APPLICATION OR WORKING WIDTH

Application Width [Straight Implement Type or Staggered Implement Type] or Working Width [Spreader Implement Type] is used to enter the width of the single section or width of each section to calculate the total width of the implement.

### Single Section

No section control is available on the system.

Application Width or Working Width is used to enter the total width of the single section of the implement. Range is 3.28 to 246.06 feet / 1.0 to 75.0 meters.





1. Press CONFIGURATION side tab .
2. Press **Implement**.
3. Press the Application Width [Straight Implement Type] or Working Width [Spreader Implement Type] KEYPAD icon .
4. Use the numeric keypad to enter a value.
5. Press RETURN arrow  or CONFIGURATION side tab  to return to the main Configuration screen.





Figure 6-22: Single Section – Application or Working Width

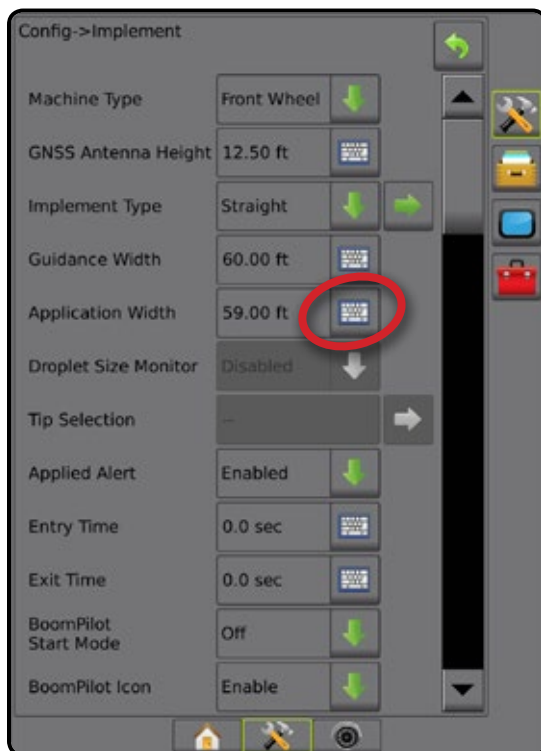

### Multiple Sections

Section control is available (SmartCable, Section Driver Module (SDM), or Switch Function Module (SFM) or ISOBUS).

Application Width or Working Width is used to enter the width of each section to calculate the total width of all sections of the implement. Each section can be a different width. Sections are numbered from left to right while facing in the machine's forward direction. Range for each section is 0.0 to 246.06 feet / 0.0 to 75.0 meters. Total for all sections must be greater than 3.28 feet / 1.0 meter.

1. Press CONFIGURATION side tab .
2. Press **Implement**.
3. Press the Application Width [Straight Implement Type or Staggered Implement Type] or Working Width [Spreader Implement Type] KEYPAD icon .
4. Highlight the section to be entered or edited.
5. Press the KEYPAD icon .
6. Use the numeric keypad to enter the width of the selected section.
7. Press RETURN arrow  or CONFIGURATION side tab  to return to the Implement screen or main Configuration screen.

*NOTE: If Symmetric Implement Layout is enabled, only the first of each pair of aligned sections will be available to be highlighted.*

Figure 6-23: Multiple Sections – Application or Working Width

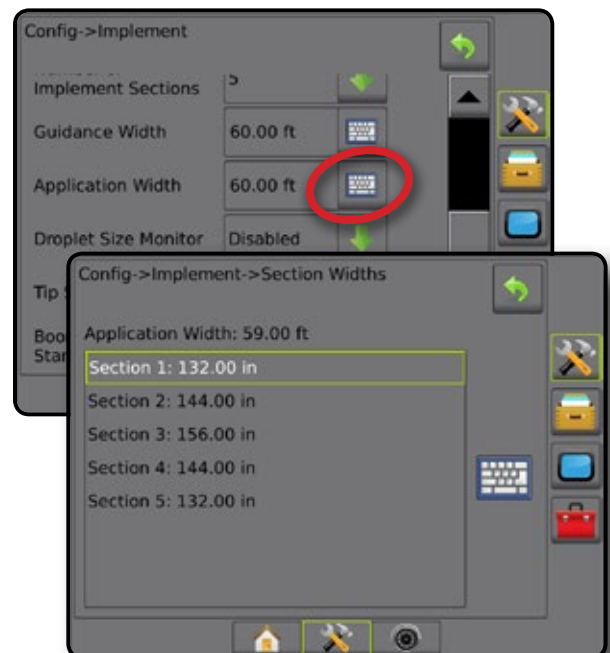

## LATERAL IMPLEMENT OFFSET DISTANCE ADJUSTMENT

Lateral implement offset distance is used to enter the distance from the center line of the machine to the center of the implement. When on-screen mapping shows no overlap or gap, yet field application produces an overlap or gap consistently to only one side in the direction of travel, an adjustment to the lateral implement offset distance should be calculated and made to the implement offset distance value.

If using a self-propelled sprayer or spreader, use the GNSS Offset Adjustment Calculation to calculate the implement offset distance adjustment.

If using a pull behind or trailed implement, use the Implement Offset Adjustment Calculation to calculate the implement offset distance adjustment.

*NOTE: While using assisted/auto steering, if on-screen mapping shows overlaps and gaps, adjustments may need to be made to the assisted/auto steering settings.*

### GNSS Offset Adjustment Calculation

To calculate a GNSS offset adjustment using the same guideline:

1. Create a straight AB line.
2. With assisted/auto steering engaged, drive pass ① at least 100 feet / 30 meters, and place flags at the draw bar or next to the machine.
3. Turn around and engage assisted/auto steering on pass ② on the same AB guideline. Place flags at the draw bar or next to the machine, or stop while on the AB guideline next to the flags you placed on pass ①.
4. Measure the difference ③ between the flags of pass ① and pass ②.
5. Divide the measured distance ③ in half. This difference will be the offset adjustment.
6. Increase or decrease the offset distance as needed dependent on where the field application overlap occurs and the current implement offset direction setting.

Figure 6-24: Lateral Implement Offset Distance

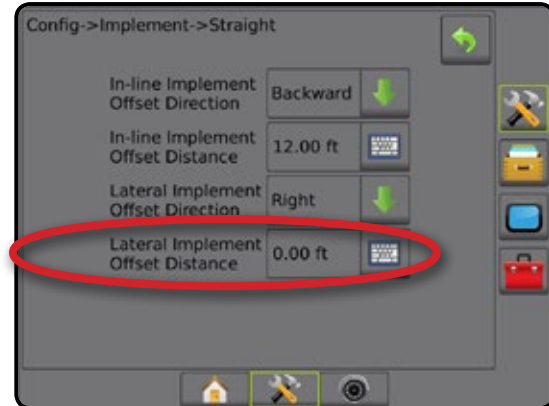

Field Application Overlap	Current Offset Settings		
	Offset Direction = Left	Offset Direction = Right	Offset Direction = Right Offset Distance = 0 ft/m
To the right of pass ①	Increase distance offset value	Decrease distance offset value	Increase distance offset value
To the left of pass ①	Decrease distance offset value	Increase distance offset value	Change to implement offset direction to left and increase distance offset value

Figure 6-25: GNSS Offset Distance

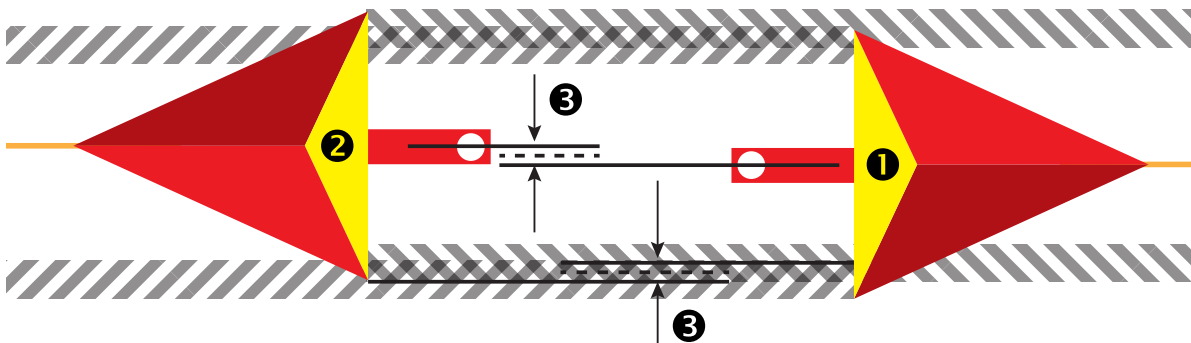

## Lateral Implement Offset Adjustment

To calculate an implement offset adjustment using adjacent guidelines:

1. Create a straight AB line.
2. With assisted/auto steering engaged, drive pass **1** as if you were operating the implement, and place flags at the outside edges of the implement.
3. Turn around and engage assisted/auto steering on pass **2** on the adjacent AB guideline. Place additional flags at the outside edges of the implement or stop while on the AB guideline next to the flags you placed on pass **1**.
4. Measure the difference **3** between the flags of pass **1** and pass **2**.
5. Divide the measured distance **3** in half. This difference will be the offset adjustment.
6. Increase or decrease the offset distance **4** as needed dependent on where the field application overlap occurs and the current implement offset direction setting.

Field Application	Current Offset Settings		
	Offset Direction = Left	Offset Direction = Right	Offset Direction = Right Offset Distance = 0 m
Overlap on the right of pass <b>1</b> or Gap on the left of pass <b>1</b>	Increase distance offset value	Decrease distance offset value	Increase distance offset value
Overlap on the left of pass <b>1</b> or Gap on the right of pass <b>1</b>	Decrease distance offset value	Increase distance offset value	Change to implement offset direction to left and increase distance offset value

Figure 6-26: Lateral Implement Offset Distance and Direction

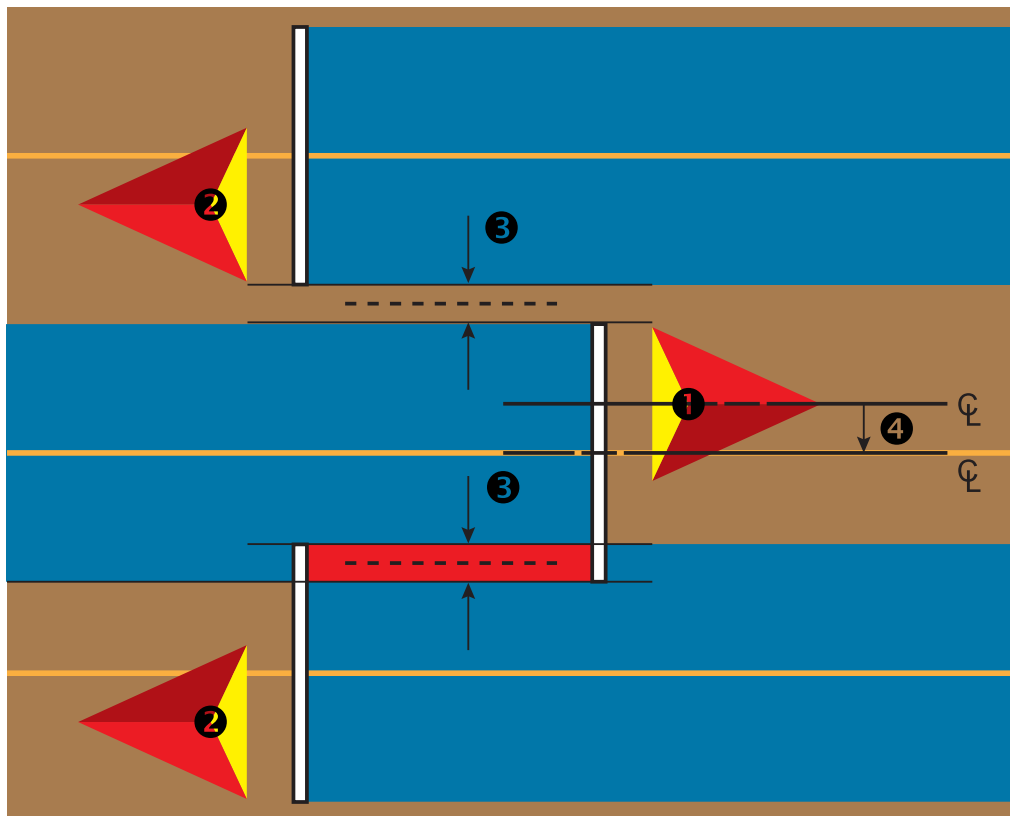



## REVERSE SENSE MODULE

Reverse Sense Module Setup is used when adding a Reverse Sense Module to any configuration. This allows for application mapping and control, and on-screen guidance when traveling in reverse.

1. Press CONFIGURATION side tab .
2. Press **Implement**.
3. In addition to standard options, select from:
  - ▶ Allow BoomPilot in Reverse – used to enable BoomPilot function while traveling in reverse
  - ▶ Reverse Signal Delay – used to set the delay when going from forward to reverse or reverse to forward, after which the vehicle icon on a navigation screen changes direction

Figure 6-27: Reverse Sense Module



## Reverse on Guidance Screens

While traveling in reverse, having BoomPilot in Reverse active will allow for automatic section control. Application mapping and application rate control will function as if the machine was going forward.

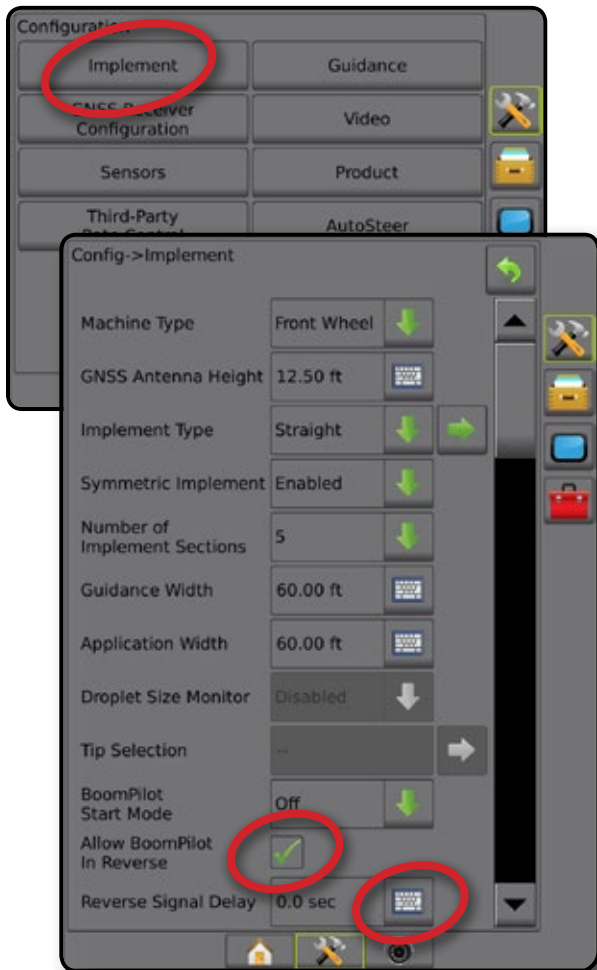
- ◀ Speed on the Guidance Bar will turn red while traveling in reverse

Figure 6-28: Traveling Forward

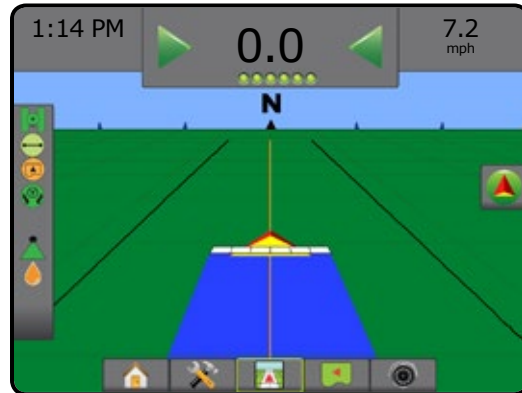
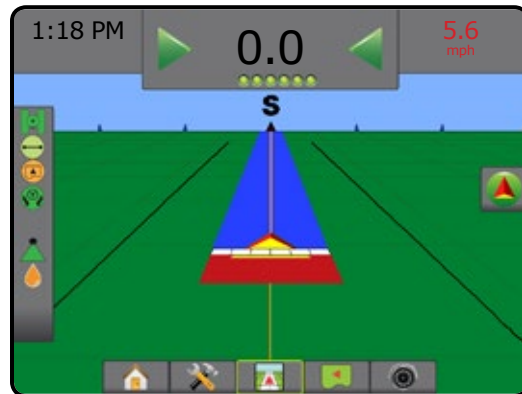

Figure 6-29: Traveling in Reverse



### Availability with Assisted/Automatic Steering

Assisted/Automatic Steering System	Reverse Sense Module (RSM)	Section Driver Module (SDM)	Allow BoomPilot in Reverse Availability	Reverse Signal Delay Availability
FieldPilot IV	✓	✓	✓	✓
FieldPilot Pro / UniPilot Pro	✓	✓	✓	✗

## TIP SELECTION

When the system includes a Pressure Sensor Interface Kit (PSIK), Tip Selection is used to select the type of sprayer tip (series and capacity) for determining droplet size information.





1. Press CONFIGURATION side tab .
2. Press **Implement**.
  - ◀ Current Tip selection is shown in the information box
3. Press Tip Selection NEXT PAGE arrow .
4. Select from:
  - ▶ Tip Preset 1-5 – selects up to five (5) tips for quick recall, and selected the current tip for determining droplet size information
  - ▶ Current Tip – displays the current tip
5. Press RETURN arrow  or CONFIGURATION side tab  to return to the main Configuration screen.

Figure 6-30: Droplet Size Monitor



### Preset

Tip presets allow saving of up to five tips for quick recall.

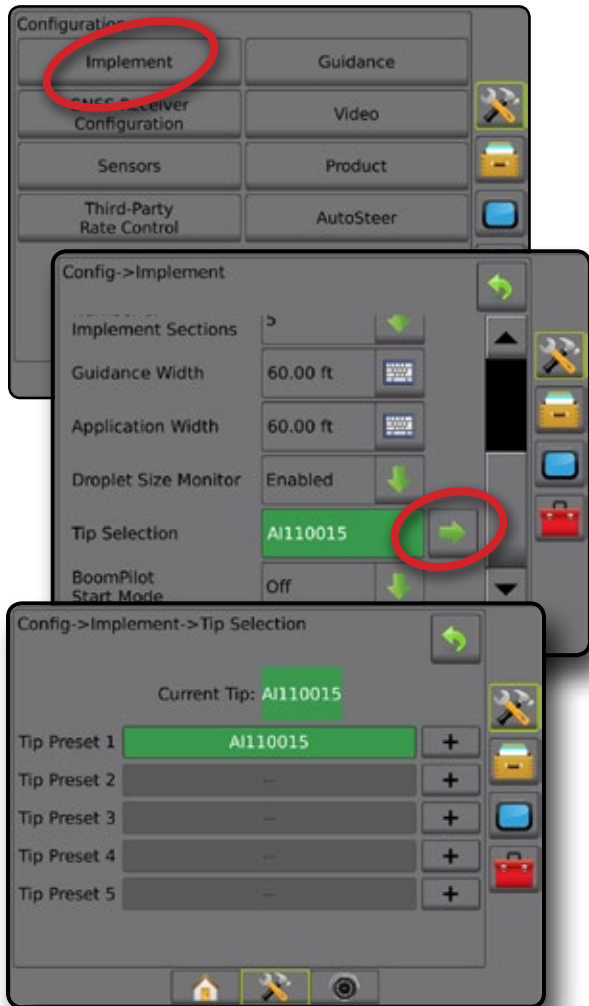
1. Press **+**.
2. Select a TeeJet tip series.
3. Select tip capacity.

Figure 6-31: Preset Tip

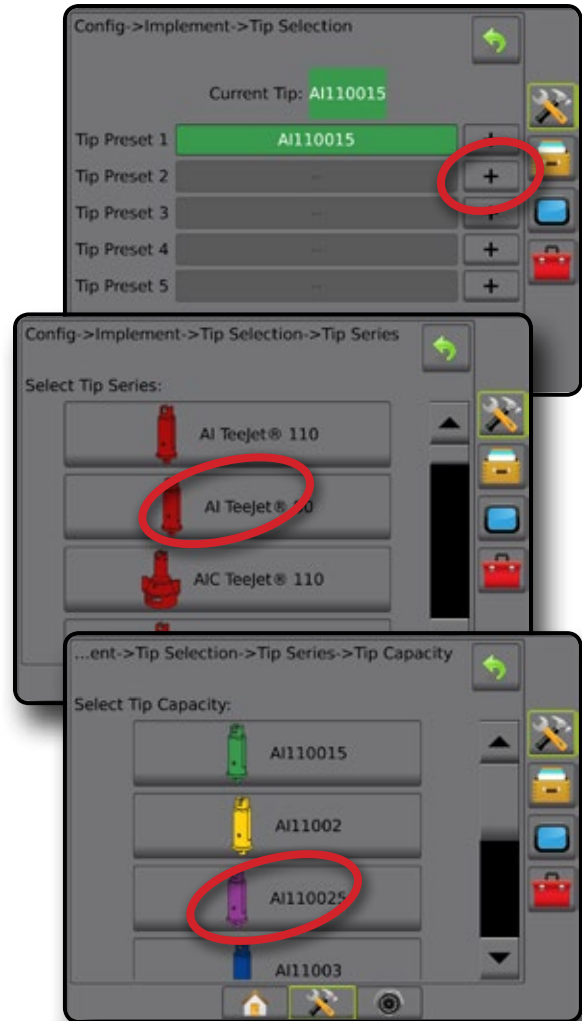

## Current Tip

Current Tip shows the active tip for determining current droplet size information. Tips must be preset to be available for current tip selection.

1. Press desired tip.

Selected tip will be shown:

- ◀ The information box on the Implement screen
- ◀ The Droplet/Pressure Status display from the status bar on the guidance screens

Figure 6-32: Current Tip

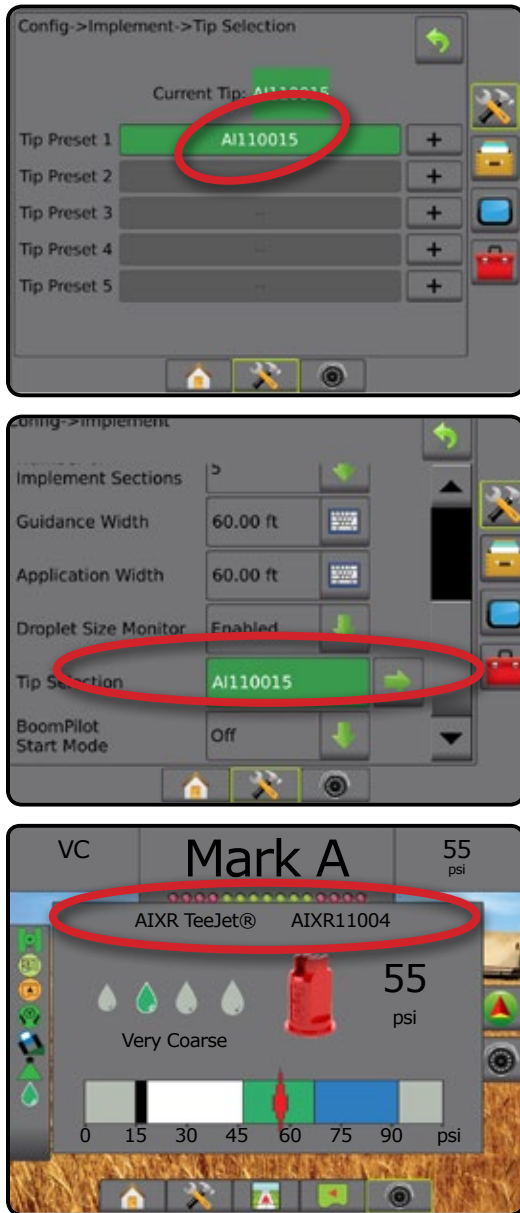

## DROPLET SIZE MONITOR

When the system includes a Pressure Sensor Interface Kit (PSIK), Droplet Size Monitor can be enabled/disabled. The DSM then becomes available on the operation screens.

### Setup

#### Enable/Disable DSM

1. Press CONFIGURATION side tab
2. Press **Implement**.
3. Press **Droplet Size Monitor**.
4. Select if droplet size monitor is enabled or disabled.
5. Press RETURN arrow or CONFIGURATION side tab to return to the main Configuration screen.

NOTE: When Droplet Size Monitor is disabled, the Droplet/Pressure Status is not available on the guidance screen status bar.

Figure 6-33: Droplet Size Monitor

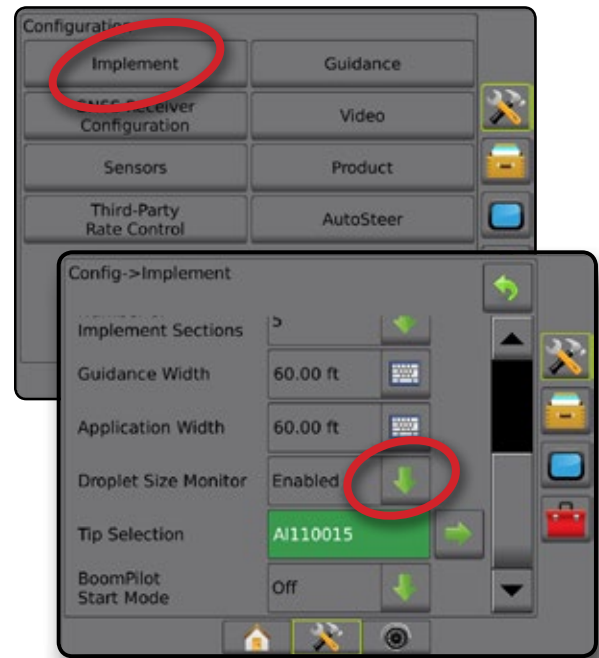

## Tip Selection / Current Tip

To establish the tip presets and current tip, see "Tip Selection" in this chapter.

## Input/Output Module Pressure Sensor

When a Pressure Sensor Interface Kit is present, Pressure Sensor options are used to enter the sensor manufacturer's maximum pressure rating and set high and low user determined pressure alarms.

*NOTE: For more information, see "Sensors" in the Setup chapter of this manual.*

## Operation

### Status Bar

Droplet/Pressure Status displays information regarding the current status of the droplet size and system pressure.





1. Press DROPLET/PRESSURE STATUS icon .
2. Press the screen anywhere to return to the guidance screen.

Figure 6-34: Droplet/Pressure Status

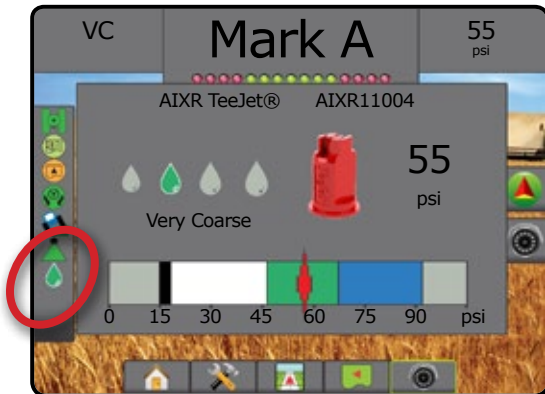

### Droplet/Pressure Status

-  Colored = Engaged. The color of the droplet is directly associated with the current droplet size. Color options include: 
-  Crossed Out = Disabled
- No icon = no Pressure Sensor Interface Kit is installed on system

## Droplet Size Chart

When choosing a spray tip that produces droplet sizes in one of the eight droplet size classification categories, always remember that a single tip can produce different droplet size classifications at different pressures. A tip might produce medium droplets at low pressures, while producing fine droplets as pressure is increased.

Category	Symbol	Color Code
Extremely Fine	XF	Violet
Very Fine	VF	Red
Fine	F	Orange
Medium	M	Yellow
Coarse	C	Blue
Very Coarse	VC	Green
Extremely Coarse	XC	White
Ultra Coarse	UC	Black

## Guidance Bar

The Guidance bar keeps you informed of your choice of selectable information including Current System Pressure and Current Droplet Size.

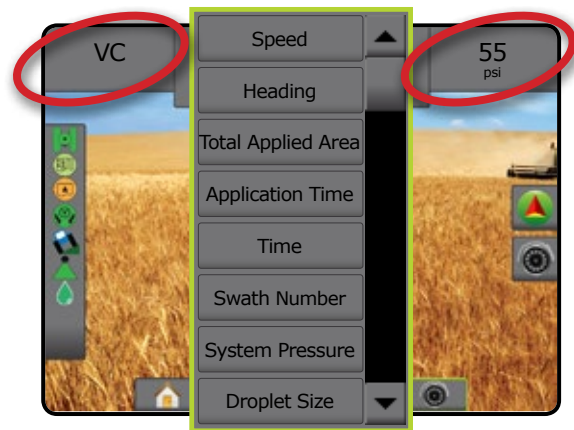

1. Press SELECTABLE INFORMATION box.
2. Select from:
  - ▶ System Pressure – displays the current system pressure
  - ▶ Droplet Size – displays the current tip droplet size
3. Press outside the selection box to return to the guidance screen.

Figure 6-35: Guidance Bar Selectable Information



## BOOMPILLOT

Depending on if there is a section control system present and when present what kind of section control is being used as well as what options are enabled, there are multiple options for BoomPilot section control. The settings of BoomPilot Start Mode and BoomPilot Icon change how section control is handled on the guidance screens.

1. Press CONFIGURATION side tab .
2. Press **Implement**.
3. Select from:
  - ▶ BoomPilot Start Mode – used to enable automatic BoomPilot activation by speed (otherwise manually by icon)
  - ▶ BoomPilot Icon – used to activate icon for manually controlling BoomPilot
4. Press RETURN arrow  or CONFIGURATION side tab  to return to the main Configuration screen.

### BoomPilot Start Mode

BoomPilot Start Mode is used to set if the BoomPilot control is started automatically by speed, or manually by the BoomPilot icon.



1. Press CONFIGURATION side tab .
2. Press **Implement**.
3. Press DOWN arrow  to select Off or Automatic.
  - ◀ Off – BoomPilot will be controlled by the BoomPilot icon in the Navigation and Guidance options on the guidance screens
  - ◀ Automatic – BoomPilot will be controlled by speed

Figure 6-36: BoomPilot Icon





## BoomPilot Icon

The BoomPilot Icon is used to activate an icon in the Navigation and Guidance options on the guidance screens for manually controlling BoomPilot



1. Press CONFIGURATION side tab .
2. Press **Implement**.
3. Press DOWN arrow  to select Enable or Disable.
  - ◀ Enable – BoomPilot Icon will be available in the Navigation and Guidance options on the guidance screens to control automatic section control
  - ◀ Disable – BoomPilot Icon will not be available in the Navigation and Guidance options

Figure 6-37: BoomPilot Icon

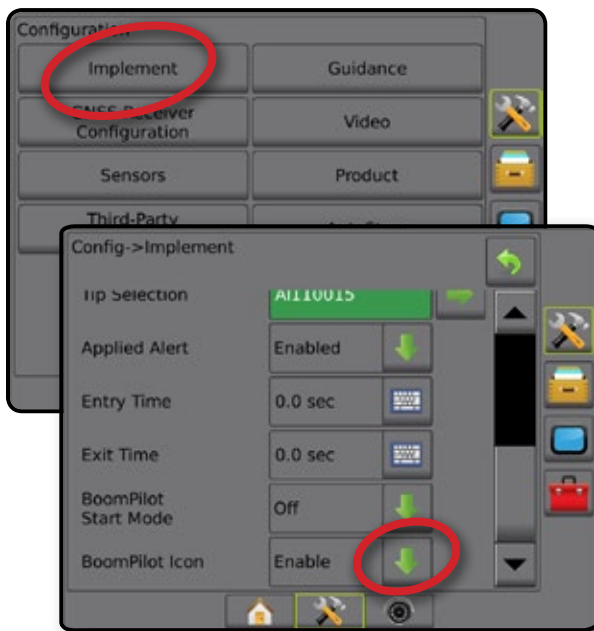











Figure 6-38: BoomPilot Icon on Guidance Screen



## CHAPTER 7 – GUIDANCE

The Matrix Pro GS allows product application and vehicle guidance to be performed simultaneously. Once unit setup is complete, guidance can begin. Five guidance modes allow the operator to optimize the field work: Straight AB , Curved AB , Circle Pivot , Last Pass  and NextRow . Additional optimization can be accomplished with Boundary Application , Curved Lookahead , Return to Point  Guidance and RealView Guidance Over Video .

Three guidance screens assist in keeping you informed.

**Vehicle View Guidance** creates a computer-generated image of the vehicle position displayed in the application area.

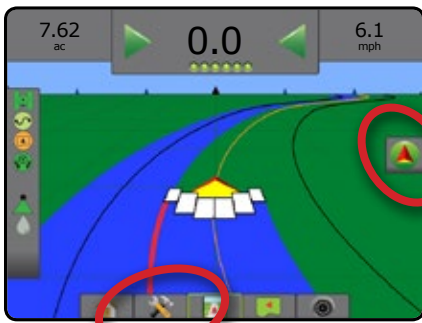



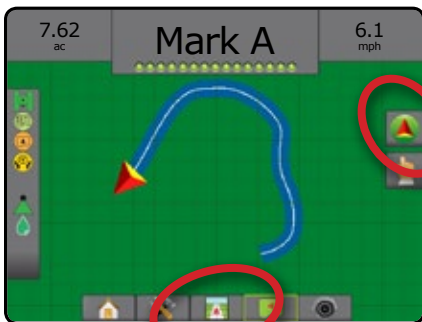





**Field View Guidance** creates a computer-generated image of vehicle position and application area from an aerial perspective.



**RealView Guidance** allows live video input to be displayed instead of a computer-generated image.



To choose a Guidance Mode:

1. Press NAVIGATION AND GUIDANCE OPTIONS tab  to display navigation options.
2. Press GUIDANCE MODE icon .
3. Select from:
  - ▶ Straight AB Guidance 
  - ▶ Curved AB Guidance 
  - ▶ Circle Pivot Guidance 
  - ▶ Last Pass Guidance\* 
  - ▶ NextRow Guidance\* 
  - ▶ No Guidance 





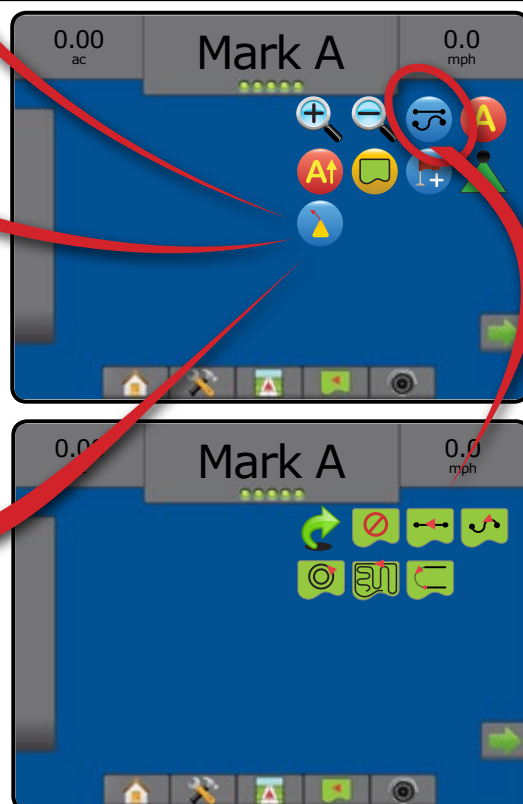







*\*Guidance options may not be available depending on assisted/automatic steering system installed.*





Figure 7-1: Choose a Guidance Mode









## Navigation Screens Options















### Navigation and Guidance Options

Guidance Mode	
	Guidance Mode – access to guidance mode options
	Straight AB Guidance  – provides straight-line guidance based on A and B reference points
	Curved AB Guidance  – provides guidance along curved lines based on an initial AB reference line
	Circle Pivot Guidance  – provides guidance around a central location that radiates inward or outward based on an initial AB reference line
	Last Pass Guidance  – offers true last-pass navigation
	NextRow Guidance  – indicates where the NextRow is located, and provides guidance at row ends to the next adjacent row
	No Guidance – turns off guidance

Boundaries	
	Mark Boundary – establishes application area and determines no-apply zones. While creating an external or initial boundary, the boundary line will be to the exterior of the outer-most section. While creating an interior or additional boundary, the boundary line will be to the interior of the inner-most section. Grayed = GNSS is unavailable.
	Finish Boundary – finalizes boundary process. Boundaries can also be closed by travelling to within a swath width of the starting point. Grayed = minimum distance has not been travelled.
	Cancel Boundary – cancels the new mark boundary process. Reverts to previous boundary (when established).
	Delete Boundary – deletes all established boundaries from current job.

BoomPilot	
	Toggles the Automatic Sprayer Control (ASC) on or off. Grayed = GNSS is unavailable.

Return to Point	
	Mark Point  – establishes a point at the vehicle location. Grayed = GNSS is unavailable.
	Return to Point Guidance – provides distance and guidance back to an established point.
	Delete Point – deletes the Marked Point.
	Cancel Guidance – hides the distance and guidance back to the Marked Point.

Guidelines	
	Mark A  – marks the first point of the guideline.
	Mark B  – marks the end point of the guideline. Grayed = minimum distance has not been travelled.
	Cancel Mark A – cancels the Mark A process. Reverts to previous AB guideline (when established).
	NextRow Mark B  – marks the end point of the row.
	Azimuth Degree  – establishes a straight guideline measured by degrees clockwise from a north-south baseline. North = 0, East = 90, South = 180, West = 270.
	A+ Nudge – shifts the existing guideline to the vehicle's current position.
	Next Straight Guideline – shows the next straight AB or Azimuth Degree guideline saved in the current job.
	Next Curved AB Guideline – shows the next Curved AB guideline saved in the current job.
	Next Circle Pivot Guideline – shows the next Circle Pivot AB guideline saved in the current job.
	Curved Lookahead – indicates where the current steering will take the vehicle using a 'pointer' as guidance.

## Screen Options

Zoom in/out	
	Icons – to be used on the Matrix Pro 570GS
	Buttons – to be used on the Matrix Pro 840GS
	Vehicle view – icons or buttons adjust the vehicle's view or perspective to the horizon from vehicle view to bird's eye view.
	Field view – icons or buttons increase/decrease the area displayed on the screen.

Pan	
	Arrows – move the displayed map area in the corresponding direction without moving the vehicle.
	World View – extends the screen view to the widest area available.

## RealView Guidance Options

	Video Camera Select – selects one of up to eight camera views if a Video Selection Module (VSM) is attached.
	Split Camera View – selects one of two sets of four camera inputs (A/B/C/D or E/F/G/H) to divide the screen into four separate video feeds.
	Guidance Over Video Setup – access to turn on Guidance Over Video or Steering Angle and adjust guidelines.
	Guidance Over Video – places three-dimensional guidelines over the video feed for navigational assistance.
	Steering Angle – displays the direction in which the steering wheel needs to be adjusted.
	Up & Down Icons – used to adjust the guidance lines and horizon line to match the camera's view.
	Camera Image Capture – saves a still photo of the current view on the screen to a USB drive.

## GUIDANCE BAR

The Guidance bar keeps you informed of your choice of selectable information, navigation activity, and section status.

### Navigation Activity & Boom Status

GNSS Status – displays “No GNSS” when GNSS is unavailable, or “Slow GNSS” when GNSS is receiving GGA data at less than 5Hz

Cross Track Error – displays the distance from your desired guideline

Current Activity – displays activities such as mark an A or B point, approaching the end of a row, indicating to turn now, and distance to return to a marked point

Section Status – one dot is displayed for each section programmed: a green dot indicates the section is active, and a red dot indicates the section is not active

Figure 7-2: Navigation Activity/Section Status

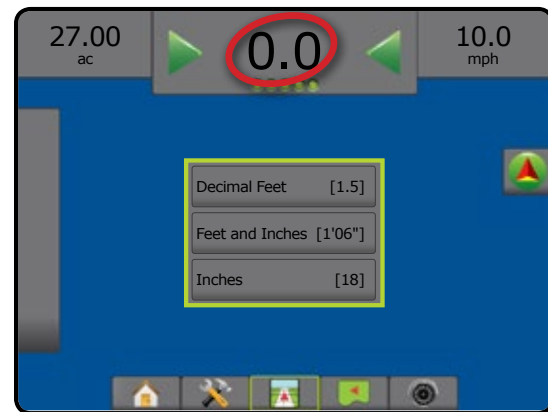

### Cross Track Error

The distance around the guideline that is perceived as zero error can be adjusted using Configuration-> Guidance-> Guidance Sensitivity.

To change the format in which the distance is displayed:

1. Press the Navigation Activity box on the guidance bar.
2. Select the measurement format.

## Selectable Information

Speed – displays the current speed of travel

Heading – displays the course of travel based clockwise from a north-south baseline. North = 0°, East = 90°, South = 180°, West = 270°.

Total Applied Area – displays the total accumulated area that has had product applied, including double-coverage areas

Application Time – displays the total time application is active during the current job

Time – displays the current time based on the selected time zone

Swath Number – displays the current swath number in reference to the initial AB guidance line, facing in the direction from A to B. Number will be positive when the vehicle is to the right of the AB baseline, or negative when the vehicle is to the left of the AB baseline.

System Pressure – displays the current system pressure (available only when an Input/Output Module is on the system)

Droplet Size – displays the current tip droplet size (available only when an Input/Output Module is on the system)

Figure 7-3: Selectable Information

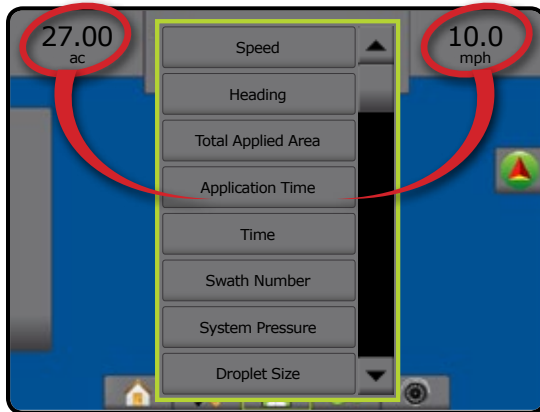

## STATUS BAR

The Status Bar provides information on GNSS status, guidance mode, boundary area, assisted/auto steering engagement, tilt correction, implement control status, droplet/pressure status, tip flow status, and rate control status.

When an icon is pressed, the related status information is displayed.

Figure 7-4: Status Bar

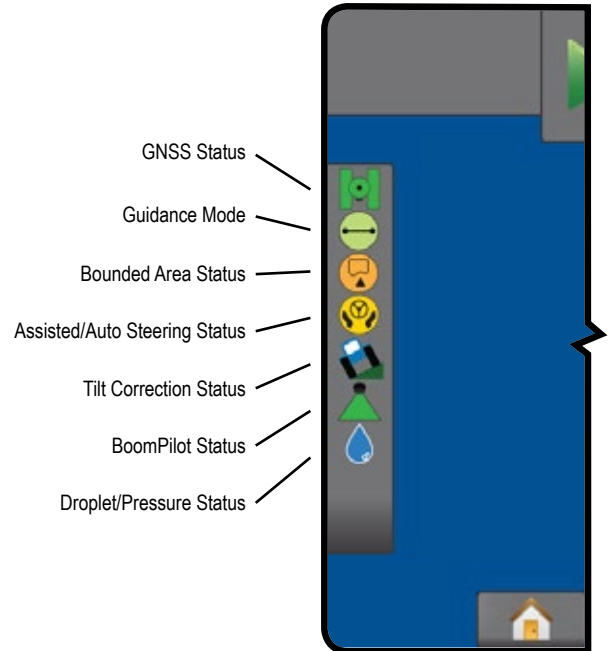

### GNSS Status

- Green = GPS, GLONASS, or SBAS (with or without DGPS Required)
- Yellow = GPS only
- Red = no GNSS
- Orange = Glide/ClearPath

### Guidance Mode



- Straight AB Guidance
- Curved AB Guidance
- Circle Pivot Guidance
- Last Pass Guidance
- NextRow Guidance
- No Icon = no Guidance

### Bounded Area Status



- Outside Boundary = traveling outside bounded area
- Inside Boundary = traveling inside bounded area
- No Icon = no boundary established





## Assisted/Auto Steering Status

-  Green = engaged, actively steering
-  Yellow = enabled, all conditions have been met to allow for assisted/auto steering
-  Red = disabled, all conditions have not been met to allow for assisted/auto steering
- No Icon = no assisted/auto steering system installed











## Tilt Correction Status

-  Colored = engaged, actively applying tilt correction
-  Red = disabled
- No Icon = no tilt gyro module installed on system, or tilt is associated with assisted/auto steering system

## BoomPilot Status

-  Green = automatic
-  Yellow = all on
-  Red = off/manual
- No Icon = single section (no SmartCable or SDM installed on system)

## Droplet/Pressure Status

-  Colored = engaged. The color of the droplet is directly associated with the current droplet size. Color options include:        
-  Crossed Out = disabled
- No Icon = no Pressure Sensor Interface Kit installed, no pressure sensor monitor on the DCM

## Status/Information Screens

### GNSS Status

GNSS Status displays information regarding current GNSS status, including data rates, number of satellites in view, HDOP and PRN status, receiver and version, satellite quality and ID, and UTM zone.

1. Press GNSS STATUS icon 



### Guidance Mode Status

Guidance Mode Status displays information regarding the pattern of guidance, the name of the current guideline, and how many guidelines are saved in the console.

1. Press GUIDANCE MODE icon 

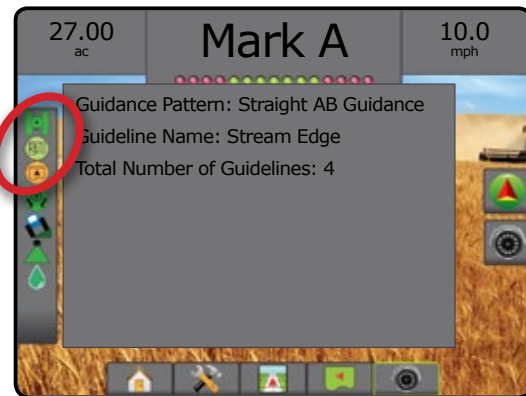

## Bounded Area Status

Bounded Area Status displays information regarding the areas in the current boundaries.

1. Press BOUNDED AREA icon  .

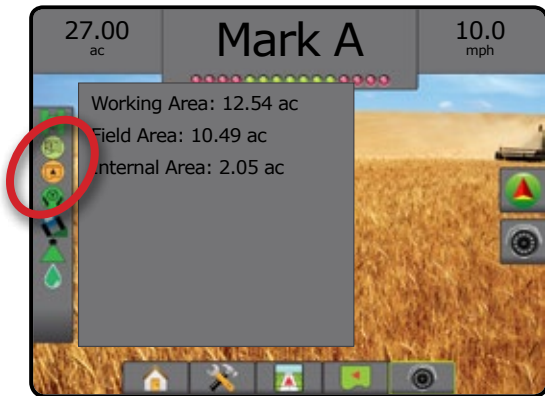

## BoomPilot Status

BoomPilot Status displays information regarding the current status of the BoomPilot system.

1. Press BOOMPILLOT STATUS icon   .

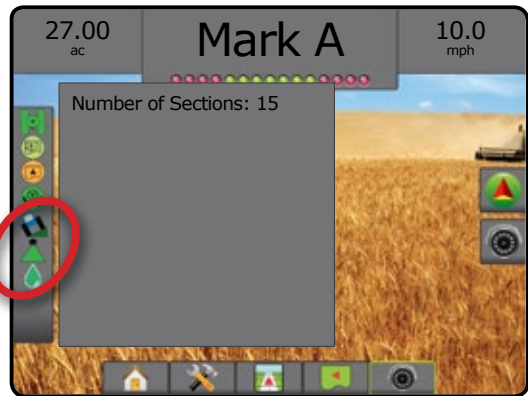

## Assisted/Auto Steering Status

Assisted/Auto Steering Status displays information regarding the current status of the assisted/auto steering system, including tilt status.

1. Press ASSISTED/AUTO STEERING STATUS icon   .

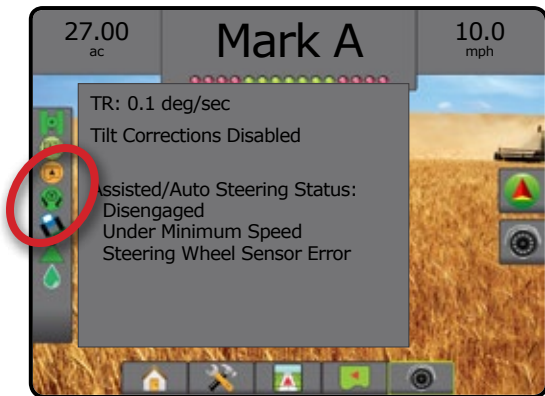

## Droplet/Pressure Status

Droplet/Pressure Status displays information regarding the current status of the droplet size and system pressure.

1. Press DROPLET/PRESSURE STATUS icon       .

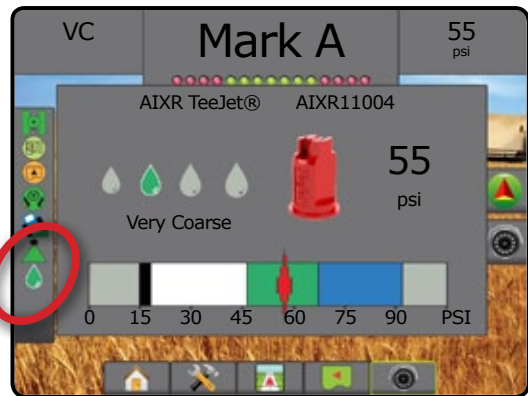

## Tilt Correction Status

Tilt Correction Status displays information regarding the current status of the tilt correction system.

1. Press TILT CORRECTION STATUS icon  .

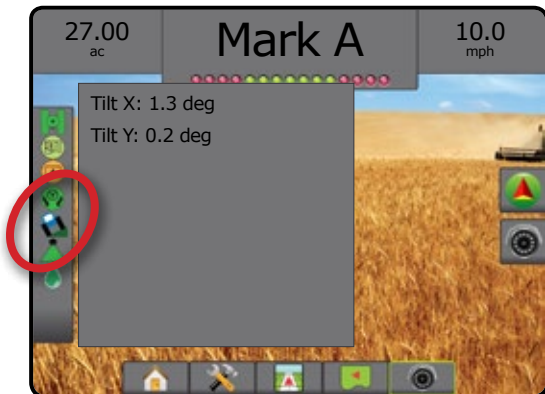

# Matrix® Pro 570GS • Matrix® Pro 840GS

INTRODUCTION

HOME

FULL SCREEN

SETUP

GNSS

IMPLEMENT

**GUIDANCE**

RATE CONTROL

APPENDIX

## NAVIGATION SCREENS

Guidance and navigation can be accessed from the Vehicle View screen, Field View screen, or RealView screen.





- Press NAVIGATION AND GUIDANCE OPTIONS tab  to display navigation options.
- Press REALVIEW OPTIONS tab  to display camera setup and guidance options.

Figure 7-5: Guidance Screen Options

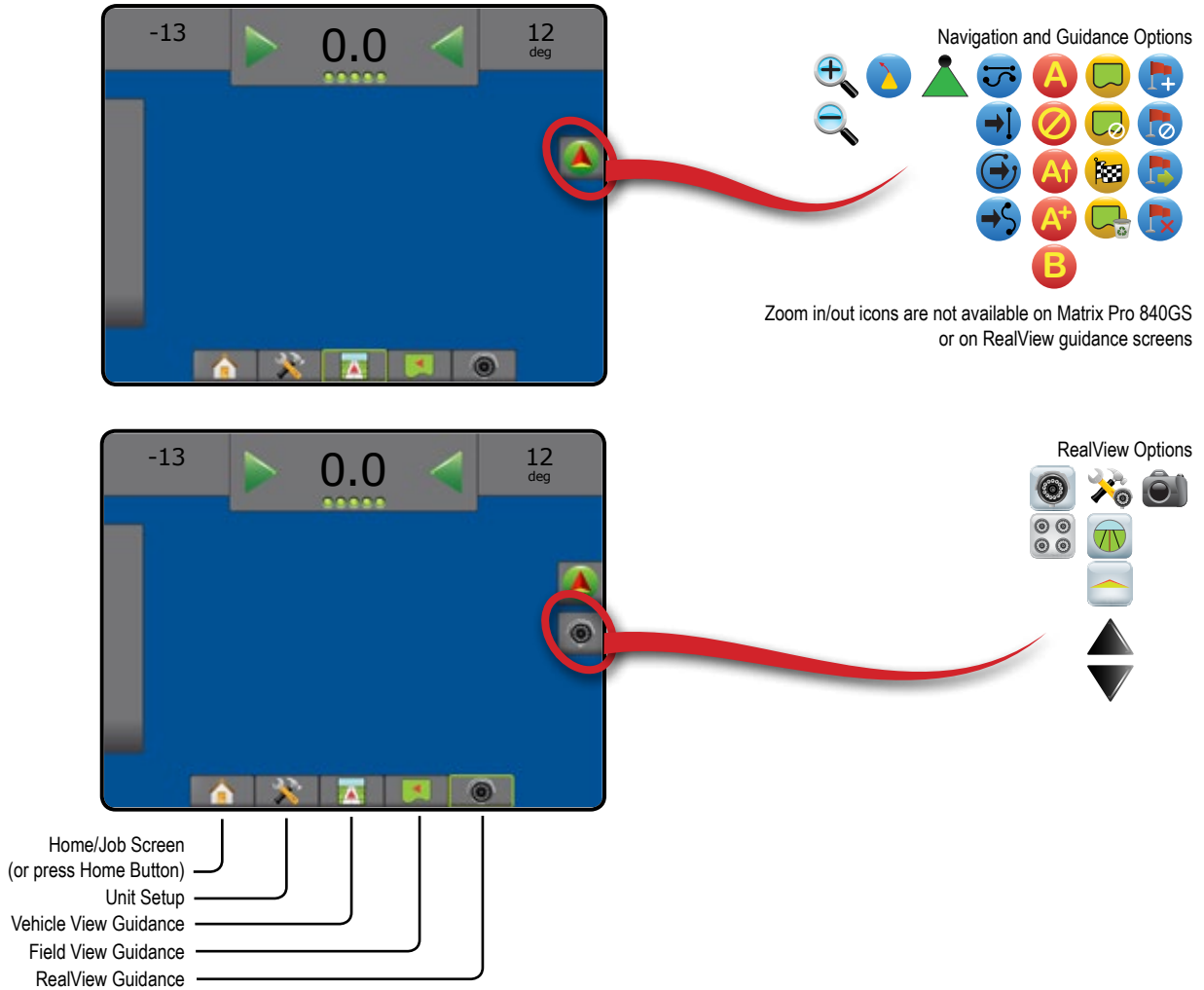

## Vehicle View

 Vehicle View creates a computer-generated image of the vehicle position displayed in the application area. From this screen all setup and navigation options can be accessed via the Options tabs on the right side of the screen.

To access the Vehicle View screen:

1. Press VEHICLE VIEW GUIDANCE tab .

Figure 7-6: Vehicle View

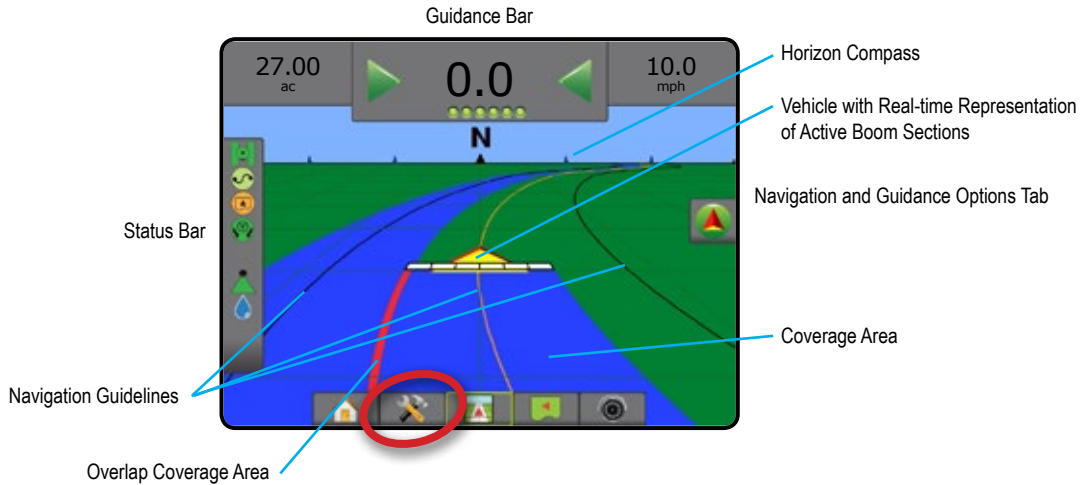



### On Screen Guidance

- Guidelines
  - ◀ Orange – active guidance line
  - ◀ Black (multiple) – adjacent guidance lines
  - ◀ Black – boundary line
- Points – markers for established points
  - ◀ Red Point – Return to Point
  - ◀ Blue Point – Mark A
  - ◀ Green Point – Mark B
- Horizon Compass – general heading can be displayed on horizon (when zoomed in)
- Coverage Area – illustrates applied area and overlap:
  - ◀ Blue – one application
  - ◀ Red – two or more applications
- Sections
  - ◀ Empty boxes – inactive sections
  - ◀ White boxes – active sections

### Navigation and Guidance Options Tab



### Matrix Pro 840GS console button assistance

- Zoom in/out & perspective – the Up/Down buttons   adjust the vehicle's view or perspective to the horizon from vehicle view to bird's eye view.

## Field View

Field View creates a computer-generated image of the vehicle position and application area from an aerial perspective. From this screen, all setup and navigation options, as well as Pan Mode, can be accessed via the Option tabs on the right side of the screen.

To access the Field View screen:

1. Press FIELD VIEW GUIDANCE tab .

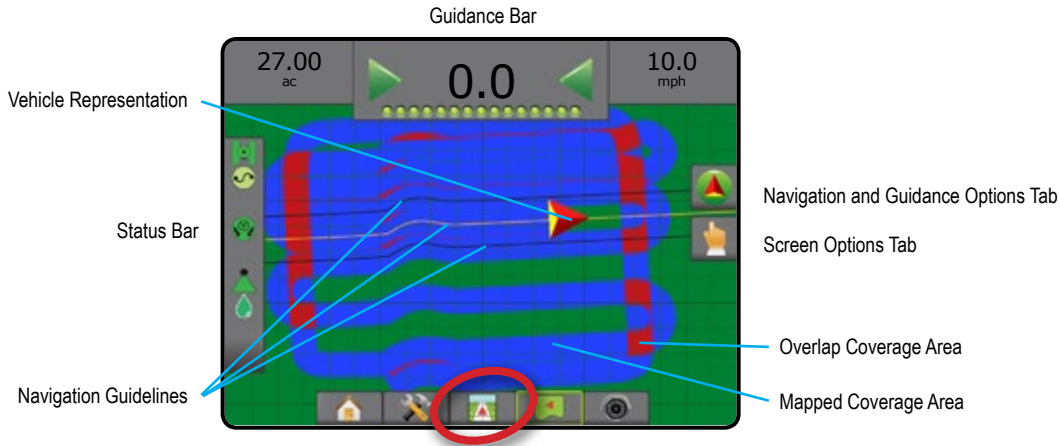

Figure 7-7: Field View



### On Screen Guidance

- Guidelines
  - ◀ Orange – active guidance line
  - ◀ Black (multiple) – adjacent guidance lines
  - ◀ Black – boundary line
- Points – markers for established points
  - ◀ Red Point – Return to Point
  - ◀ Blue Point – Mark A
  - ◀ Green Point – Mark B
- Coverage Area – illustrates applied area and overlap
  - ◀ Blue – one application
  - ◀ Red – two or more applications

### Matrix Pro 840GS console button assistance

- Zoom in/out – the Up/Down buttons   adjust the map's visible area.

### Navigation and Guidance Options Tab



### Screen Options Tab

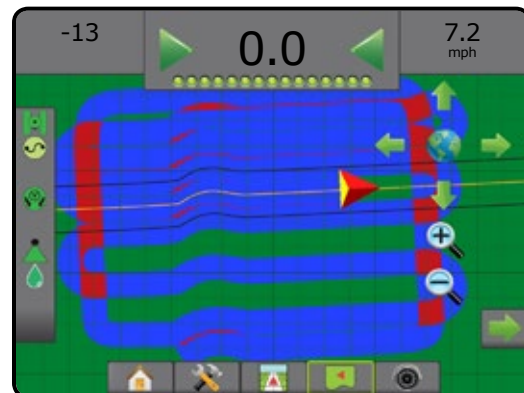



## RealView Guidance

RealView Guidance allows live video input to be displayed instead of a computer-generated image. From this screen all setup and navigation options can be accessed via the tabs on the right side of the screen. To adjust the camera view [reverse, upside down], go to Setup-> Configuration-> Video.

- ▶ Single Camera – a single camera is directly attached to the console
- ▶ Video Selection Module – if a Video Selection Module (VSM) is installed on the system, two (2) video options are available:
  - One Camera View – one of up to eight camera inputs can be selected to change the view of the video input.
  - Split Camera View – one of two sets of four camera inputs (A/B/C/D or E/F/G/H) can be selected to divide the screen into four separate video feeds.

To access the RealView screen:

1. Press REALVIEW GUIDANCE tab 

Figure 7-8: RealView Guidance



## On Screen Guidance

- Guidelines
  - ◀ Orange – active guidance line
  - ◀ Black (multiple) – adjacent guidance lines
  - ◀ Horizontal Black Line – adjustable horizon line







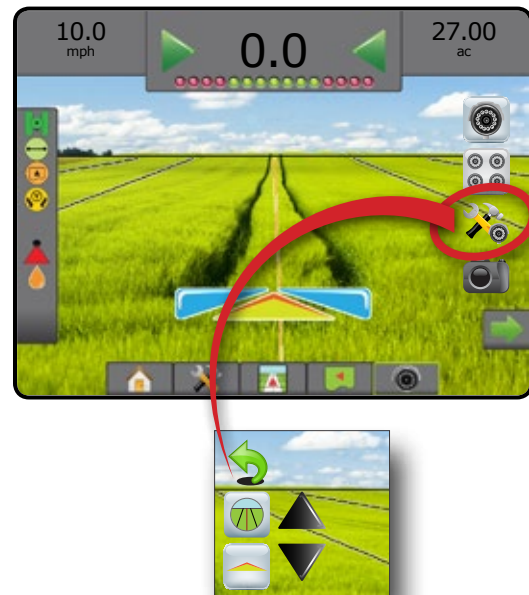

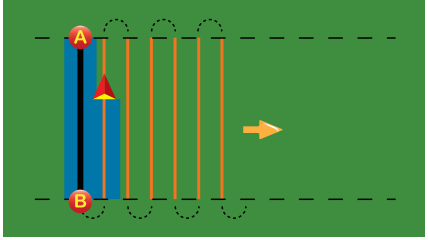

## Navigation and Guidance Options Tab

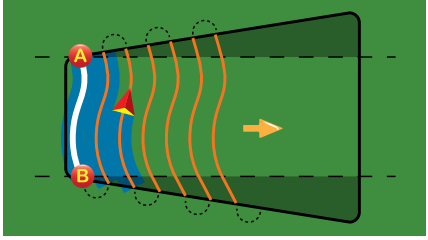

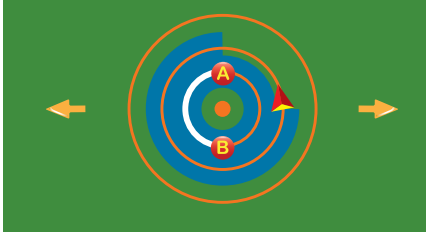
## RealView Options Tab (with VSM)

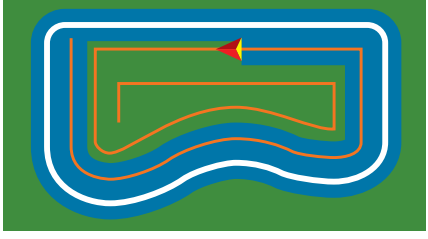

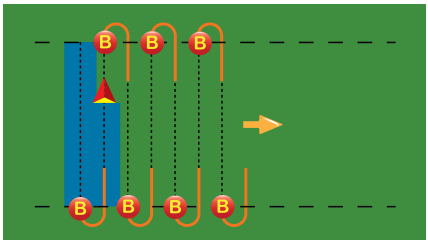

## GUIDANCE MODES

	<h3>Straight AB Guidance</h3> <p>Straight AB Guidance provides straight-line guidance based on A and B reference points. The original A and B points are used to calculate all other parallel guidelines.</p> <p><i>NOTE: Offset to adjacent guidelines will be calculated using the guidance width: see "Configuration" in the System Setup chapter.</i></p>	
	<h3>Curved AB Guidance</h3> <p>Curved AB Guidance provides guidance along curved lines based on an initial AB reference line. This initial baseline is used to calculate all other guidelines.</p> <p><i>NOTE: Curved guidance is recommended not to exceed 30° within the AB guideline.</i></p> <p><i>Offset to adjacent guidelines will be calculated using the guidance width: see "Configuration" in the System Setup chapter.</i></p> <p><i>HINT: While working in a bounded area, the guidance pattern extending beyond the established AB points will be straight-line guidance.</i></p>	
	<h3>Circle Pivot Guidance</h3> <p>Circle Pivot Guidance provides guidance around a central location that radiates inward or outward based on an initial AB reference line. This initial baseline is used to calculate all other guidelines.</p> <p>It is used for product application in a center pivot field while being guided along a circular guideline that matches a center pivot irrigation system radius.</p> <p><i>NOTE: Offset to adjacent guidelines will be calculated using the guidance width: see "Configuration" in the System Setup chapter.</i></p>	
	<h3>Last Pass Guidance</h3> <p>Last Pass Guidance* offers true last-pass navigation. The console will automatically detect the nearest applied area and establish parallel guidelines based on that area.</p> <p><i>NOTE: If a boundary is established but no application occurred during the boundary process, guidance will not initiate.</i></p>	
	<h3>NextRow Guidance</h3> <p>NextRow Guidance* indicates where the NextRow is located, and provides guidance at row ends to the next adjacent row. When the operator marks the end of the row and begins turning to the next row, a Straight AB guidance line is provided in the next row. When the vehicle is in the NextRow, guidance is turned off.</p> <p><i>NOTE: Offset to NextRow will be calculated using the guidance width: see "Configuration" in the System Setup chapter.</i></p> <p><i>The NextRow Guidance does not support skipping rows.</i></p>	
	<h3>No Guidance</h3> <p>No Guidance* turns off guidance.</p> <p><i>NOTE: No Guidance Mode does not delete established guide lines or points from the console. To delete established/saved data from the console, see "Data Management" in the System Setup chapter.</i></p>	

\*Guidance options may not be available depending on assisted/automatic steering system installed.

## GUIDELINES

AB guidelines, Azimuth guidelines, next pass guidelines, and NextRow guidelines are each available depending on the current guidance mode. Up to 25 established guidelines can be stored in the console per job. Switching from one guidance mode to another will change the current available guidelines.



Multiple guidelines can be created in each guidance mode. If more than one guideline is saved in a single guidance mode, the Next Guideline feature will become available. By pressing the Next Guideline    option, the vehicle will be directed to the next guideline saved in the console.

A user can duplicate and edit jobs for reuse of boundaries and guidelines for different applications over the same field using Fieldware Link or the Data -> Job Data -> Manage option.

### Curved Lookahead Guideline

 The curved lookahead guideline provides an indication of where the current steering will take the vehicle using a 'pointer' as guidance. The Curved Lookahead option is available in all guidance modes.

To activate the Curved Lookahead guideline:



1. Press NAVIGATION AND GUIDANCE OPTIONS tab  to display navigation options.
2. Select CURVED LOOKAHEAD icon .

The pointer will be visible on the navigation screen.



Figure 7-9: Curved Lookahead







To remove the Curved Lookahead guideline:

1. Press NAVIGATION AND GUIDANCE OPTIONS tab  to display navigation options.
2. Select CURVED LOOKAHEAD icon .

### Marking A and B Points

  To establish an AB guideline:

1. Drive to the desired location of Point A .
2. Press NAVIGATION AND GUIDANCE OPTIONS tab  to display navigation options.
3. **While the vehicle is in motion**, press MARK A icon .
4. Drive to the desired location of Point B .
5. Press MARK B icon  to establish the AB line.
6. "Would you like to name this guideline?"  
Press:
  - ▶ Yes – to enter a name and save the guideline in the console
  - ▶ No – to automatically generate a name and save the guideline in the console

The console will begin providing navigation information.

*NOTE: The MARK B Icon  is not available for selection (grayed out) until the minimum distance is travelled (9.84 feet / 3.0 meters in Straight or Curved guidance, 164.04 feet / 50.0 meters in Circle Pivot guidance).*

*NOTE: It is not necessary to drive the entire circumference of the center pivot in order to initiate Circle Pivot Guidance.*

Use CANCEL MARK icon  to cancel the Mark A command and revert to the previous guideline (when established).

Figure 7-10: Mark A Point

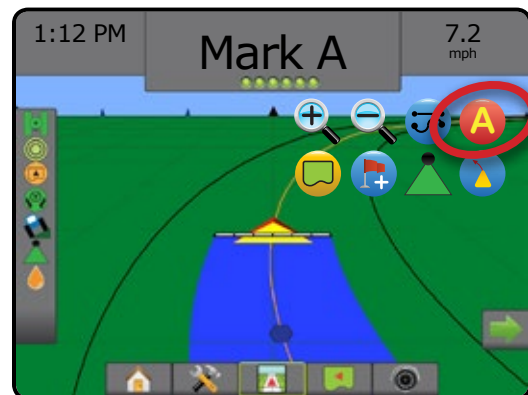

Figure 7-11: Mark B Point



Figure 7-12: Save Guideline



Figure 7-13: Follow Guidance

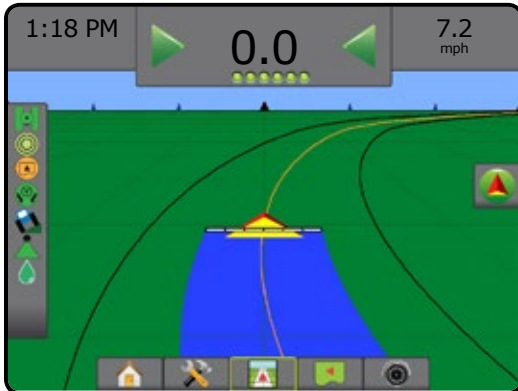

## A+ Nudge Feature

**A+** The A+ Nudge feature allows the current guideline to be shifted to the vehicle's current location.

To adjust the guideline:



1. Press NAVIGATION AND GUIDANCE OPTIONS tab  to display navigation options.
2. Press A+ NUDGE icon **A+**.

Figure 7-14: A+ Nudge





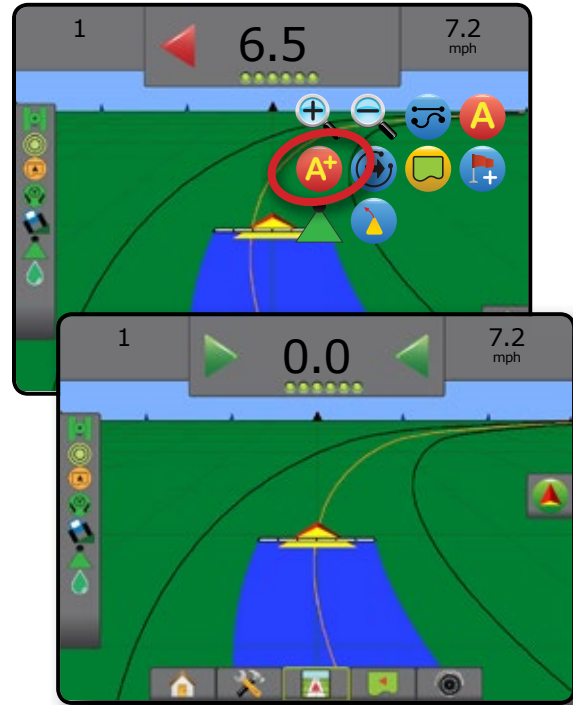

## Next Guideline Feature

 If more than one guideline is saved, the Next Guideline feature will become available. By pressing the Next Guideline option, the vehicle will be directed to the next guideline saved in the console.

To change to other available guidelines:

1. Press NAVIGATION AND GUIDANCE OPTIONS tab  to display navigation options.
2. Press NEXT GUIDELINE icon .

Toggle between all guidelines by pressing the NEXT GUIDELINE icon  again.

Figure 7-15: Next Guideline



To view which guideline is active, press the Guidance Mode icon on the Status Bar.

Figure 7-16: View Which Guideline is Active

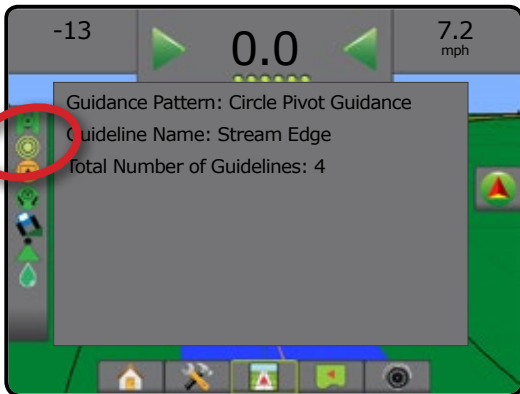

## Last Pass Guidelines

 Last Pass Guidance offers true last-pass navigation. The console will automatically detect the nearest applied area and establish parallel guideline based on that area.

*NOTE: Last Pass Guidance may not be available depending on assisted/automatic steering system installed.*

To activate Last Pass guidelines:

1. Drive to a desired location to apply the first pass.
2. Travel next to the applied area.
3. The console will begin providing navigation information.

*NOTE: If a boundary is established but no application occurred during the boundary process, guidance will not initiate.*

Figure 7-17: Apply First Pass



Figure 7-18: Follow Guidance







## NextRow Guidelines

 NextRow Guidance indicates where the next row is located based on the programmed guidance width, and provides guidance at user-marked row ends to the next adjacent row. When the operator signals the end of the row, a Straight AB line will be established in the current row and guidance provided to the NextRow. When the vehicle is in the NextRow, guidance is turned off.

*NOTE: Offset to NextRow will be calculated using the guidance width: see "Configuration" in the System Setup chapter.*

*NOTE: NextRow Guidance may not be available depending on assisted/automatic steering system installed.*

To activate NextRow guidelines:

1. Press NAVIGATION AND GUIDANCE OPTIONS tab  to display navigation options.
2. At the end of a row (while driving a straight line) press MARK B icon .
  - ◀ The end of the row will be marked with a green point .
3. Turn toward the next row.
4. Based on that direction turned, guidance will be provided for the next adjacent row.
  - ◀ When the vehicle is in the row, the guideline is removed.
5. Repeat at the end of the next row.

*NOTE: The NextRow Guidance feature does not support skipping rows.*

Figure 7-19: Mark End of Row

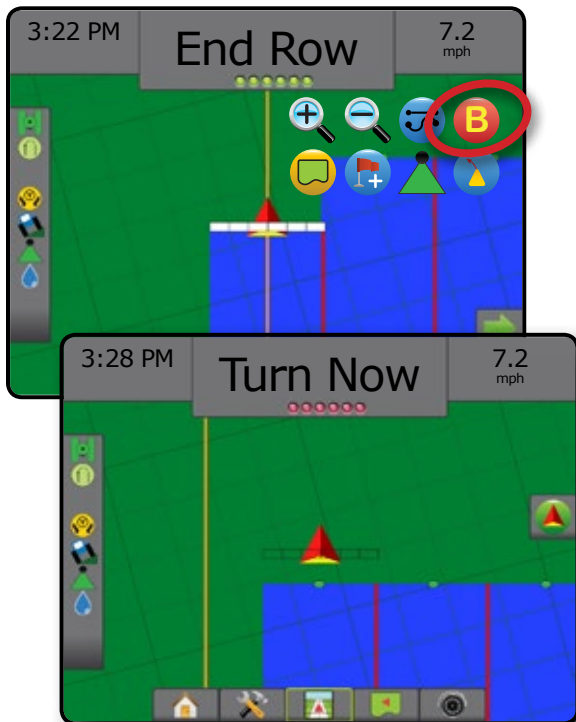



## Azimuth Degree

 An azimuth is defined as a horizontal angle measured clockwise from a north baseline. When using an azimuth, the point from which the azimuth originates is the center of an imaginary circle. North = 0°, East = 90°, South = 180°, West = 270°.

An azimuth degree can be entered to determine the exact location of the vehicle. When Straight AB Guidance mode is selected, the azimuth degree can be entered.

To establish an Azimuth Degree guideline:

1. Press NAVIGATION AND GUIDANCE OPTIONS tab  to display navigation options.
2. Press AZIMUTH icon  to enter azimuth degree.
3. Use the entry screen to establish the azimuth degree.
4. "Would you like to name this guideline?"

Press:

- ▶ Yes – to enter a name and save the guideline
- ▶ No – to automatically generate a name

The console will begin providing navigation information.

To establish additional azimuth guidelines, follow the same steps as the initial azimuth guideline.

Figure 7-20: Azimuth Guidance







## APPLICATION BOUNDARY

Application boundaries establish areas where product is and is not applied while using ABSC or BoomPilot. Boundaries can be established in all guidance modes. One exterior boundary and up to five (5) interior boundaries can be stored at one time.



Using Data -> Job Data -> Manage or with Fieldware Link, a user can duplicate and edit jobs for reuse of boundaries and guidelines for different applications over the same field.

To establish an exterior application boundary:

1. Drive to a desired location at the perimeter of the application area.
2. Press NAVIGATION AND GUIDANCE OPTIONS tab  to display navigation options.
3. While the vehicle is in motion, press BOUNDARY icon .
4. Travel the perimeter of the application area.
5. Finish the boundary:
  - ▶ Travel to within one swath width of the starting point. The boundary will close automatically (the white guideline will turn black).
  - ▶ Press BOUNDARY FINISH icon . A straight line will complete the boundary between your current location and the starting point.
6. Press:
  - ▶ Save – to save the boundary
  - ▶ Delete – to delete the boundary

**NOTE:** On the external or initial boundary, the BOUNDARY FINISH icon  is not available for selection (grayed out) until the minimum distance is travelled (five times the swath width).

If mapping a boundary with one or more sections folded in and turned off, it is necessary to maintain this section configuration for the duration of the boundary pass. Any changes made to the number of sections turned on, and therefore the width of the machine after the boundary mapping process has started, will result in the application mapping the boundary at the outer edge of all the programmed sections – not necessarily those turned on at any given time during the boundary pass.

When mapping a boundary with some sections turned off, it is necessary to turn BoomPilot to Manual mode  and turn ON the master and section switches for all sections that will be used during the boundary pass. Once the boundary pass is complete the sections switches can be turned OFF, Master switch remains ON, BoomPilot can be returned to Automatic mode  and automatic section control can then be used.

**NOTE:** If a boundary is mapped with some sections folded as described above, it may be necessary to use the A+ NUDGE icon  on the guideline over to the correct position for subsequent passes in the field.

Figure 7-21: Boundary in Progress



Figure 7-22: Finish Boundary – Straight Line to Starting Point

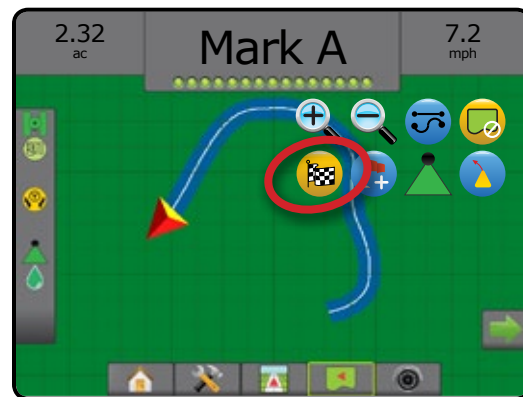



Figure 7-23: Finish Boundary – Travel to Starting Point



Figure 7-24: Save Boundary



Use CANCEL BOUNDARY icon  to cancel the new field boundary process and revert to the previous boundary (when established).

To establish one or more interior boundaries, follow the same steps as the initial boundary.

Figure 7-25: Add Interior Boundary



While creating an external or initial boundary, the boundary line will be to the exterior of the outermost active section. While creating an interior or additional boundary, the boundary line will be to the interior of the innermost active section.

If no sections are active, the boundary will be marked to the end of the outermost section.

Use DELETE BOUNDARY icon  to delete all field boundaries for the current job.

Figure 7-26: Delete Boundary





In correspondence to your current location, the IN BOUNDARY icon  or OUT BOUNDARY icon  is displayed on the Status Bar once the boundary is established.

Figure 7-27: Boundary on Status Bar



## 1+ RETURN TO POINT

Return to Point provides guidance back to an established point in Vehicle View and Field View. In Vehicle View an arrow directs the vehicle back to the established point. In Field View only the point is displayed.

A return point is job-specific, and will remain active in the active job until canceled.

*NOTE: Return to Point Guidance may not be available depending on assisted/automatic steering system installed.*

### Marking a Return Point

To mark a return point:





1. Drive to the desired location of Return Point .
2. Press NAVIGATION AND GUIDANCE OPTIONS tab  to display navigation options.
3. Press ADD POINT icon .

Figure 7-28: Return Point Established – Vehicle View

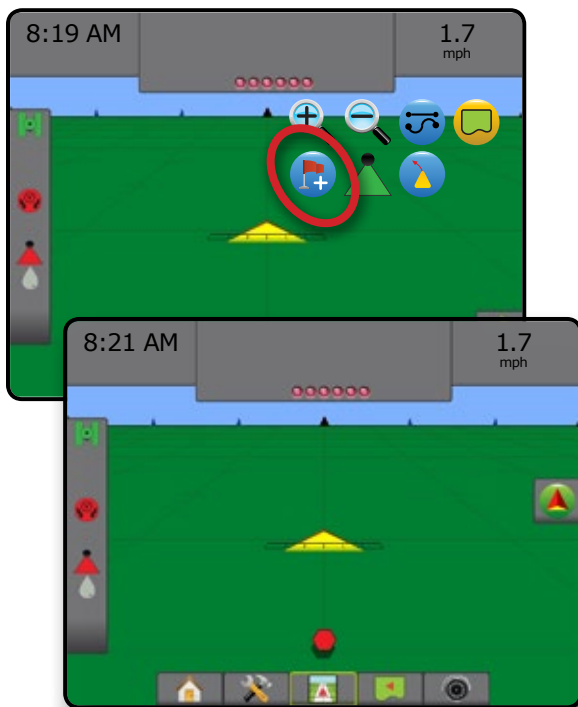

### Delete the Return Point

To delete the established return point:

1. Press NAVIGATION AND GUIDANCE OPTIONS tab  to display navigation options.
2. Press DELETE POINT icon .



Delete Point icon is not available while return to point guidance is active.

Figure 7-29: Delete Point



### Guidance to a Return Point

To show distance and guidance to the established return point:

1. Press NAVIGATION AND GUIDANCE OPTIONS tab  to display navigation options.
2. Press the RETURN TO POINT GUIDANCE icon .

The console will begin providing the distance information on the Guidance Bar from the vehicle to the established point.

Use CANCEL RETURN TO POINT GUIDANCE icon  to hide distance and guidance to the established point.

Guidance cannot be calculated when “?” appears in the guidance bar.

Figure 7-30: Return to Point Guidance – Vehicle View

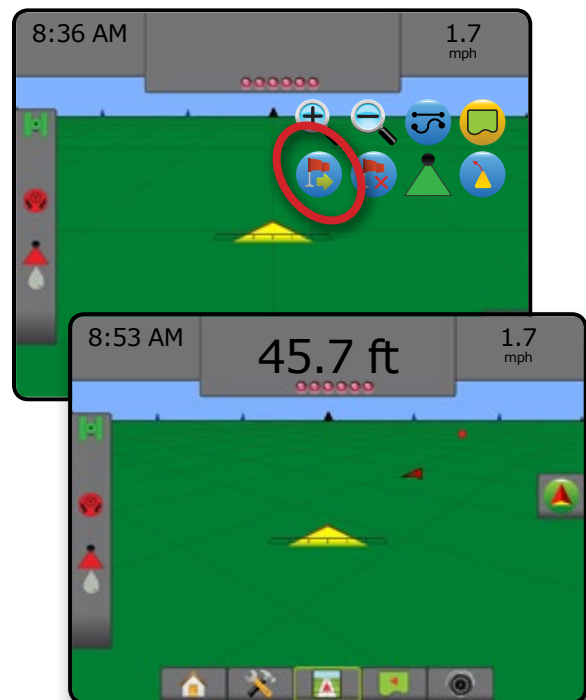



## BOOMPILOT

Depending on if there is a section control system present and when present what kind of section control is being used as well as what options are enabled, there are multiple options for BoomPilot section control.

This section includes setup options for these configurations:

- ▶ No Section Control Module
  - Console Only
  - With Optional Work On/Off Switch
- ▶ With TeeJet Section Control Module and Switchbox or ISM
- ▶ With TeeJet Section Control Module

### No Section Control Module

If a section control system is not present, the BoomPilot Icon or an optional work on/off switch is used to turn the single section on or off. Only one section width will be illustrated and the status bar will have no icon.



*NOTE: If an ISOBUS controller, SmartCable, Section Driver Module (SDM), or Switch Function Module (SFM) is present, please refer to the following sections for more information.*

*NOTE: The BOOMPILOT icon is gray  when GNSS is unavailable.*

### Console Only

The BoomPilot Icon is used to turn the section on or off.

To set configuration settings:

1. Press SYSTEM SETUP bottom tab .
2. Press CONFIGURATION side tab .
3. Press **Implement**.
4. Set "BoomPilot Icon" to **Enable**.

*NOTE: BoomPilot Start Mode setting will make no difference in the function of this option.*

To switch application off or on using the console:



1. Press NAVIGATION AND GUIDANCE OPTIONS tab  to display navigation options.
2. Press BOOMPILOT icon .
3. Press BOOMPILOT icon  to toggle the section on or off.



Figure 7-31: BoomPilot Icon and Status Bar Indicator



### With Optional Work On/Off Switch

The work on/off switch is used to turn the section on or off.

To set configuration settings:

1. Press SYSTEM SETUP bottom tab .
2. Press CONFIGURATION side tab .
3. Press **Implement**.
4. Set "BoomPilot Icon" to **Disable**.

*NOTE: BoomPilot Start Mode setting will make no difference in the function of this option.*

In areas where application is desired:

1. Turn work on/off switch to the "on" position.

In areas where application is not desired:

1. Turn work on/off switch to the "off" position.

### Using the Console



To control the section using the BoomPilot Icon while there is a work on/off switch on the system:

1. Set "BoomPilot Icon" to **Enable**.
2. Work on/off switch should remain in the "off" position.
3. Press BOOMPILOT icon  to toggle the section on or off.



## With TeeJet Section Control Module and Switchbox or ISM

SmartCable, Section Driver Module (SDM) or Switch Function Module (SFM) and a switchbox or Implement Status Module (ISM) is present.

**NOTE:** The BOOMPILOT icon is gray  when GNSS is unavailable. BoomPilot status bar icon will be off/manual .

To switch application off or on automatically:



- Automatic/Manual Boom Switch must be in the “Auto” position.  
◀Automatic – status bar icon will be green 
- Master Switch and section switches must be in the “On” position.



**NOTE:** Application can be manually controlled while in Automatic BoomPilot mode using the switches on the switchbox or switches connected to the ISM.

To switch application off or on manually:





- Automatic/Manual Boom Switch must be in the “Manual” position.  
◀Manual – status bar icon will be red 
- Use the switches on the switchbox or switches connected to the ISM.

## With TeeJet Section Control Module



SmartCable, Section Driver Module (SDM) or Switch Function Module (SFM) is present BoomPilot is used to set automatic section control to off/manual , automatic , or spot application 

**NOTE:** The BOOMPILOT icon is gray  when GNSS is unavailable. BoomPilot status bar icon will be off/manual .

To switch application off or on automatically:

- Press NAVIGATION AND GUIDANCE OPTIONS tab  to display navigation options.
- Press and release BOOMPILOT icon .  
◀Enable – status bar icon will change to green   
◀Disable – status bar icon will change to red 

To apply a spot application:

- Press NAVIGATION AND GUIDANCE OPTIONS tab  to display navigation options.
- Press and hold BOOMPILOT icon  over area to be applied.  
◀Spot Application– status bar icon will change to yellow 

## ZOOM IN/OUT

### Vehicle View

Zoom In/Out & Perspective is used to adjust the vehicle's view or perspective to the horizon from vehicle view to bird's-eye view.









- Zoom in   will adjust view to vehicle view displaying a compass on the horizon
- Zoom out   will adjust view to bird's eye view

Figure 7-32: Zoom In to Zoom Out

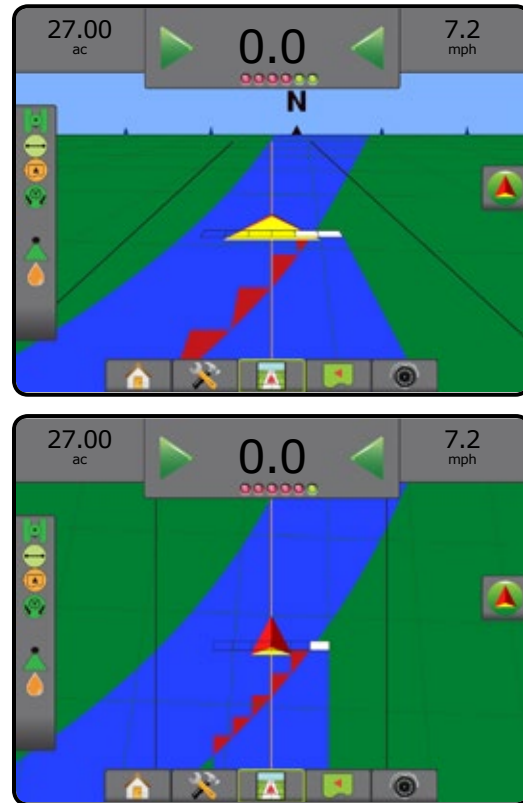

### Field View

Zoom In/Out is used to adjust the map's visible area.

- Zoom in   will decrease the amount of map area visible
- Zoom out   will increase the amount of map area visible



## PAN MODE

While in Field View Guidance, the Pan Mode allows the screen to be positioned manually as desired. The off-center position on the screen will be retained until the World icon is pressed.

To enter Pan Mode and pan across the screen:

1. Press SCREEN OPTIONS tab
2. Press:
  - ▶ AND DRAG SCREEN in the corresponding direction to move the view on screen.
  - ▶ ARROWS in the corresponding direction to move the view on screen (down, left, right, up).
  - ▶ WORLD VIEW icon to center vehicle on screen and extend the screen view to the widest area available.

*NOTE: Press & hold ARROWS to quickly adjust settings.*

To close Pan Mode options:

1. Press CLOSE OPTIONS tab

Figure 7-33: Pan Mode

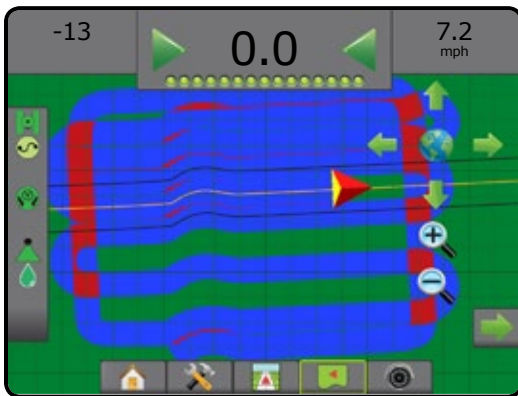

## APPLICATION MAPPING

GNSS-based product application mapping is available in Vehicle View or Field View, in any guidance mode, when Third-Party Rate Control is unlocked and a rate controller is on the system. Mapping can record areas covered by the implement (Coverage) or how much product has been applied and where (Application), and can direct single- and variable-rate product application (Preset Target Rate and Prescription, respectively).

*NOTE: For more information, see the Rate Control chapter of this manual.*

To access application mapping:

1. Press VEHICLE VIEW GUIDANCE bottom tab or FIELD VIEW GUIDANCE bottom tab .
2. Press MAPPING OPTIONS tab to display mapping options.
3. Select one or more:
  - ▶ Coverage Map – shows areas covered by the implement, regardless of whether product was applied
  - ▶ Prescription Map – pre-loaded map that provides information to the rate controller for use in applying product
  - ▶ Application Map – shows how much product has been applied and where, using color to indicate level in proportion to preset or automatically set maximum and minimum levels
  - ▶ Target Rate Map – shows the application rate that the rate controller attempted to achieve at each location

*NOTE: Application Map and Target Rate Map cannot be selected simultaneously.*

Figure 7-34: Coverage Map

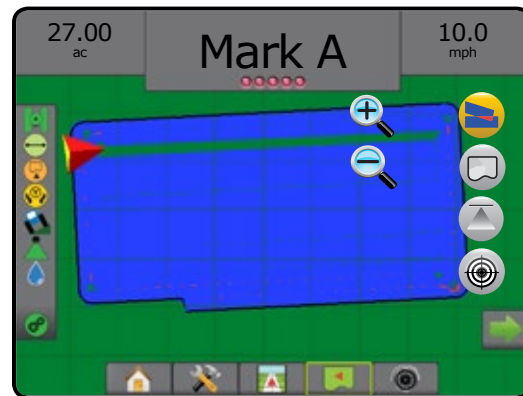

Figure 7-35: Prescription Map

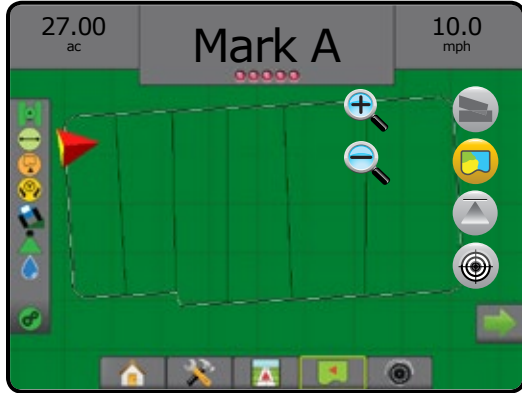

Figure 7-36: Application Map

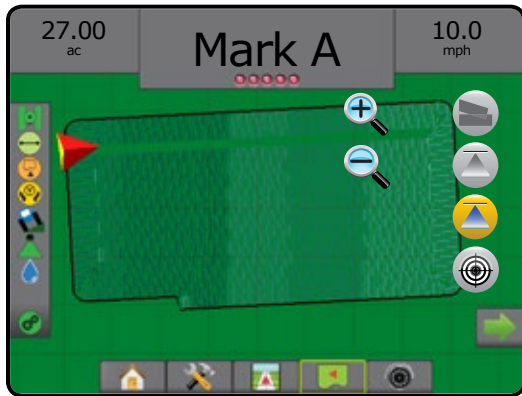
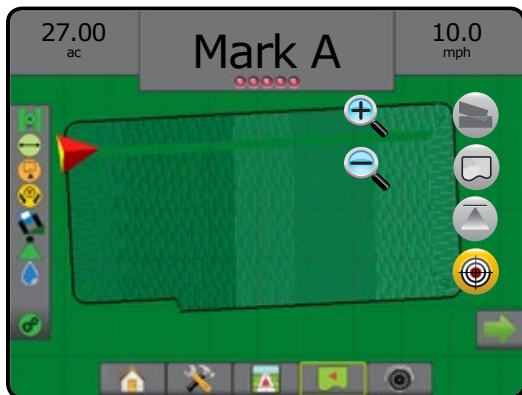

Figure 7-37: Target Rate Map



## REALVIEW SPECIFIC OPTIONS

RealView Guidance allows live video input to be displayed instead of a computer-generated image. RealView setup options accesses additional guidance tools including guidance over video and a steering angle indicator.

- ▶ **Single Camera** – a single camera is directly attached to the console
- ▶ **Video Selection Module** – if a Video Selection Module (VSM) is installed on the system, two (2) video options are available:
  - **One Camera View** – one of up to eight camera inputs can be selected to change the view of the video input.
  - **Split Camera View** – one of two sets of four camera inputs (A/B/C/D or E/F/G/H) can be selected to divide the screen into four separate video feeds.

To adjust the camera view [reverse, upside down], go to Setup-> Configuration-> Video.

To access the RealView options:







1. Press REALVIEW GUIDANCE bottom tab .
2. Press REALVIEW OPTIONS tab  to display RealView options.
3. Select from:
  - ▶ **Single Camera View**  [VSM only] – one (1) of up to eight (8) camera inputs can be selected to change the view of the video input
  - ▶ **Split Camera View**  [VSM only] – one (1) of two (2) sets of four (4) camera inputs (A/B/C/D or E/F/G/H) can be selected to divide the screen into four separate video feeds
  - ▶ **RealView Guidance Options**  – accesses additional guidance tools including guidance over video and a steering angle indicator
  - ▶ **RealView Camera Image Capture**  – saves a still photo of the current view on the screen to a USB drive

Figure 7-38: RealView Guidance



## RealView Guidance Options

RealView setup options accesses additional guidance tools including guidance over video and a steering angle indicator.







1. Press REALVIEW OPTIONS tab  to display RealView options.
2. Press REALVIEW GUIDANCE OPTIONS icon .
3. Select from:
  - ▶ Guidance Over Video  – places three-dimensional guidelines over the video feed for navigation assistance
  - ▶ Steering Angle Indicator  – displays the direction in which the steering wheel needs to be adjusted
  - ▶ Horizon Line Adjustment   – adjusts the on-screen horizon line up or down

Figure 7-39: RealView Setup Options



## Camera Snapshot

RealView Camera Snapshot saves a still photo of the current view on the screen to a USB drive.

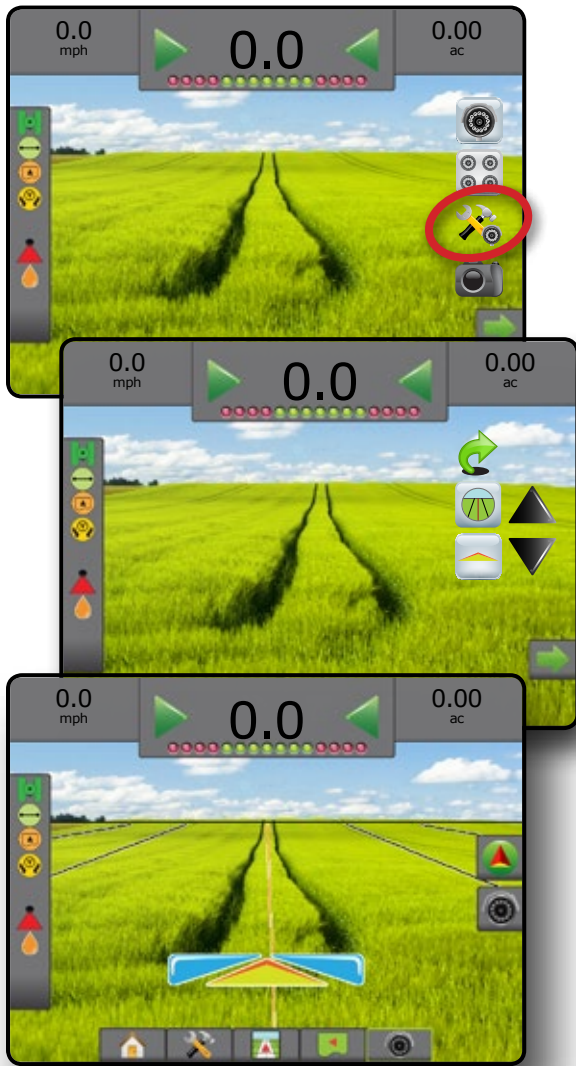

1. Insert USB drive.
2. Press REALVIEW OPTIONS tab  to display RealView options.
3. Press CAMERA SNAPSHOT icon .

Figure 7-40: RealView Camera Full Screen Video View



## VSM Camera Options

If a Video Selection Module (VSM) is installed on the system, two (2) video options are available:



1. Press REALVIEW OPTIONS tab  to display RealView options.
2. Select from:
  - ▶ Single Camera View  – one (1) of up to eight (8) camera inputs can be selected to change the view of the video input
  - ▶ Split Camera View  – one (1) of two (2) sets of four (4) camera inputs (A/B/C/D or E/F/G/H) can be selected to divide the screen into four separate video feeds



Figure 7-41: Single Camera Selection with VSM

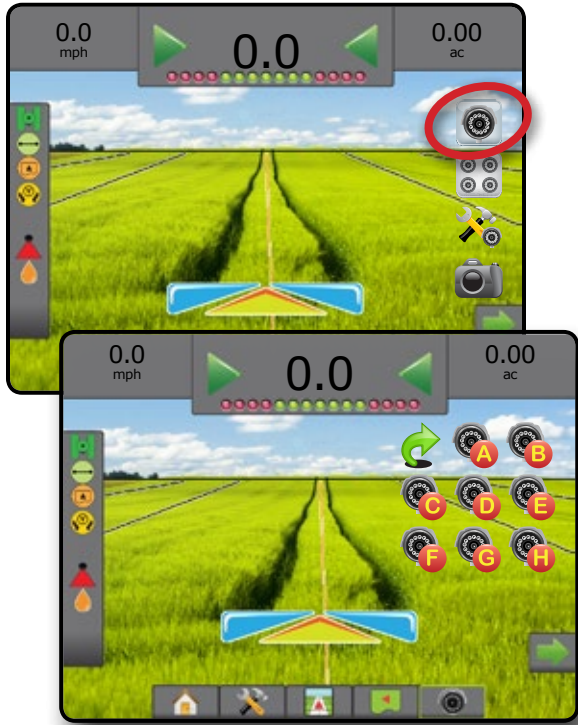

Figure 7-42: Select Split View with VSM





## CHAPTER 8 – THIRD-PARTY RATE CONTROL

When a Third-Party Rate Control system is present and Rate Control has been unlocked, application information and mapping can be shown on the guidance screens.

To add a third-party rate controller to the system:

1. Add a rate controller to the system.
2. Power on the rate controller.
3. On the Matrix Pro GS console, unlock Third-Party Rate Control.
4. Restart the Matrix Pro GS.
5. On the Matrix Pro GS console, configure Third-Party Rate Control settings – used to configure hardware interface and communication.
6. On the Matrix Pro GS console, configure Product settings – used to configure product name, tank/bin volumes, target application rates, increment for adjusting target rates, and color mapping maximum/minimum rate limits and corresponding display colors

### THIRD-PARTY RATE CONTROL UNLOCK

Feature Unlock is used to unlock advanced features.

*NOTE: The unlock code is unique for each console. Contact TeeJet Technologies Customer Service. Once unlocked, a feature remains unlocked unless the console is fully reset.*



1. Press CONSOLE side tab .
2. Press **Feature Unlock**.
3. Press the locked feature button  for Third-Party Rate Control.
4. Enter unlock code.
5. Restart the console.



Figure 8-1: Feature Unlock

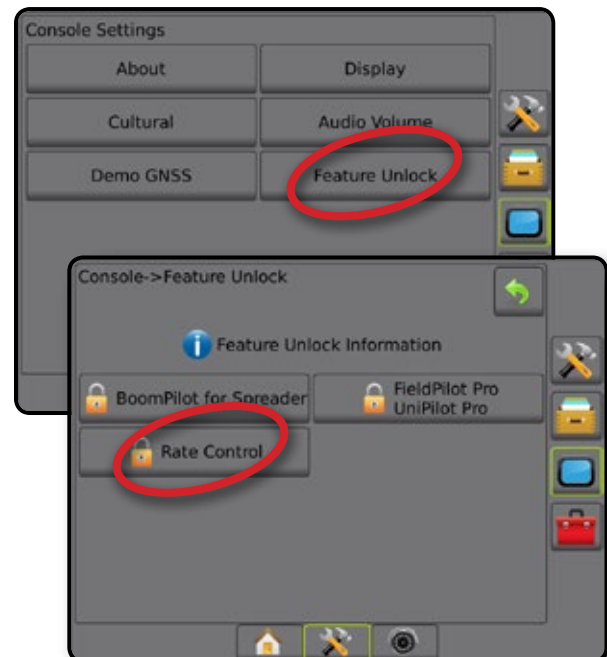

## SETUP OPTIONS

### Third-Party Rate Control

When a Third-Party Rate Control system is present and Rate Control has been unlocked, a Third-Party Rate Control can be enabled/disabled.

1. Press SYSTEM SETUP bottom tab .
2. Press CONFIGURATION side tab .
3. Press **Third-Party Rate Control**.
4. Select if Third-Party Rate Control is enabled or disabled.
5. When disabled, select from:
  - ▶ Hardware Interface – used to select an interface for communication with a third-party rate controller.
  - ▶ Communication Protocol – used to select a protocol for communication with a third-party rate controller.
  - ▶ Controller Mode – If an applicable protocol is selected, used to select the controller mode that matches rate controller's configuration.
  - ▶ Serial Baud Rate – if using a serial interface device, used to select the appropriate communication baud rate.

At any time, select:

- ▶ Rate Control Status – used to view the status of a connected third-party rate controller.

Figure 8-2: Third-Party Rate Control



### Product

When a Third-Party Rate Control system is present and Rate Control has been unlocked, Product options are available for configuring product control channel names and maximum/minimum rate limits and corresponding display colors for mapping.



1. Press SYSTEM SETUP bottom tab .
2. Press CONFIGURATION side tab .
3. Press **Product**.
4. Select from:
  - ▶ Product Name – used to enter the name of the product for the current Control Channel
  - ▶ Maximum/Minimum Rate Color – used to create the color scheme that best represents the change in rates across an application or target rate map
  - ▶ Color Range – used to select Automatic or Manual mode for setting Maximum and Minimum Rate Color
  - ▶ Applied Rate Mapping Upper Limit [Manual Color Range only] – used to set the maximum rate for which the Maximum Rate Color will be used (higher rates will use the selected Maximum Rate Color)
  - ▶ Applied Rate Mapping Lower Limit [Manual Color Range only] – used to set the minimum rate for which the Minimum Rate Color will be used (lower rates will use the selected Minimum Rate Color)

Figure 8-3: Product Options



## GUIDANCE SCREEN OPTIONS

When a Third-Party Rate Controller is integrated into the system, additional rate control and mapping options are available on the Vehicle View and Field View guidance screens.

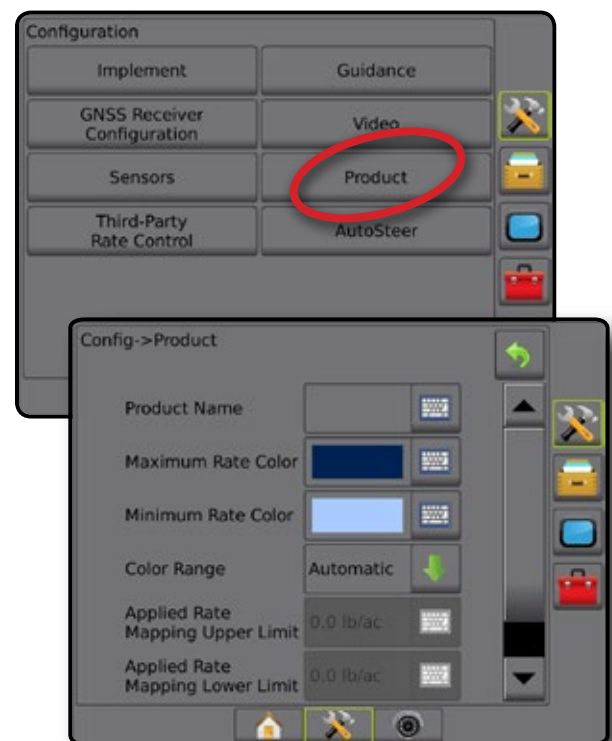
### On Screen Guidance

In addition to the standard Guidance options, the following information will become available with Third-Party Rate Control:

- Guidelines
  - ◀ Black/White – prescription map zone boundary line
- Coverage Area – illustrates applied area and overlap:
  - ◀ User Selected – Application Map and Target Rate Map applied areas show colored bars relative to selected color range and map selection.

### Guidance Bar

In addition to the standard Guidance bar options, the following selectable information will become available with Third-Party Rate Control:

- ▶ Actual Application Rate – displays the current application rate
- ▶ Target Application Rate – displays the target application rate

Figure 8-4: Guidance Bar Selectable Information

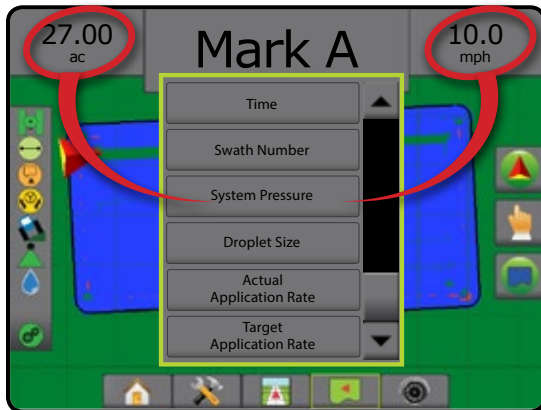

### Status Bar

In addition to the standard Status Bar bar options, the Product Rate Control Status icon provides information on rate control status.

When an icon is pressed, the related status information is displayed.

1. Press PRODUCT RATE CONTROL STATUS icon

Figure 8-5: Product Rate Control Status



### Application Mapping

GNSS-based product application mapping is available in Vehicle View or Field View, in any guidance mode when a rate controller is on the system. Mapping can record areas covered by the implement (Coverage) or how much product has been applied and where (Application), and can direct single- and variable-rate product application (Preset Target Rate and Prescription, respectively).

**NOTE:** Before using mapping, set or verify product mapping options under Configuration -> Product.

To access application mapping:

1. Press VEHICLE VIEW GUIDANCE bottom tab or FIELD VIEW GUIDANCE bottom tab .
2. Press MAPPING OPTIONS tab to display mapping options.
3. Select one or more:
  - ▶ Coverage Map – shows areas covered by the implement, regardless of whether product was applied
  - ▶ Prescription Map – pre-loaded map that provides information to the rate controller for use in applying product
  - ▶ Application Map – shows how much product has been applied and where, using color to indicate level in proportion to preset or automatically set maximum and minimum levels
  - ▶ Target Rate Map – shows the application rate that the rate controller attempted to achieve at each location

**NOTE:** Application Map and Target Rate Map cannot be selected simultaneously.

Figure 8-6: Coverage Map

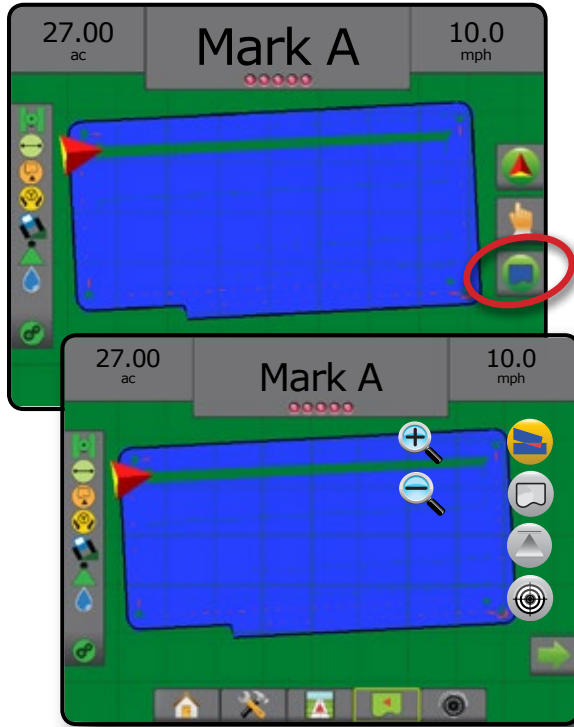

### Duplicating and Transferring Maps

Maps are stored in the job data. Using Data -> Job Data -> Manage, job data containing maps can be duplicated, or transferred to Fieldware Link so the maps can be opened, viewed, edited, and printed, and transferred back to the console. See “Job Data” in the System Setup chapter.

Using Data -> Reports, reports in multiple formats can be generated that contain data and any maps from the job.

### Coverage Map

 Coverage Map showing areas covered by the implement. DCM does not require product to be applied. ISOBUS does require product to be applied.

### On Screen Mapping

- Coverage Area – illustrates applied area and overlap:
  - ◀ Blue – one application
  - ◀ Red – two or more applications

Figure 8-7: Coverage Map

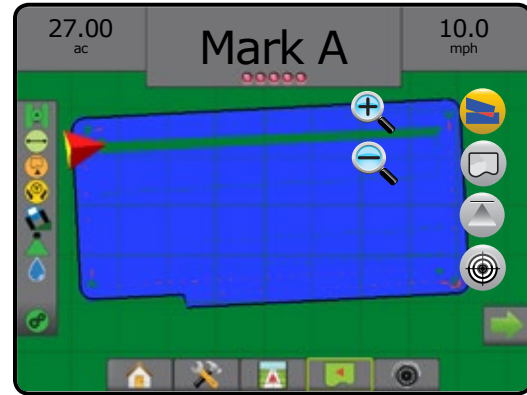

### Prescription Map

 Prescription Map is a pre-loaded map that provides information to the rate controller for use in applying product. Prescription Maps contain geo-referenced product rate information. The Matrix Pro GS can import job data containing Prescription Maps for use with variable-rate application (VRA) using compatible rate controllers.

### On Screen Mapping

- Zone lines:
  - ◀ Black when approaching the application zone.
  - ◀ White when within the application zone.
  - ◀ Other zones having the same rate will also be shown in white.
- Coverage Area – illustrates different prescription rate zones:
  - ◀ User Selected – zone colors are selected when establishing the prescription map.

With Fieldware Link (v5.01 or later), users can import VRA jobs created in Fieldware Link, as well as export job data from the console, edit the included maps to create Target Rate or Prescription Maps, and transfer back to the console for job use.

*NOTE: Advanced Job Mode is required for variable rate applications. See Options (Job Mode) in the System Setup chapter.*

Figure 8-8: Prescription Map



## Application Map

Application Map shows how much product has been applied and where, using color to indicate level in proportion to preset or automatically set maximum and minimum levels.

*NOTE: Application Map and Target Rate Map cannot be selected simultaneously.*

### On Screen Mapping

- Coverage Area – illustrates applied area:
  - ◀ User Selected – applied areas show colored bars relative to selected color range and map selection.

Figure 8-9: Application Map

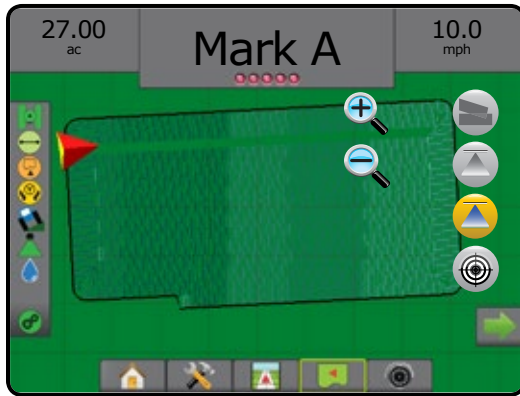

### Color Range Selection

Product options configure maximum/minimum rate limits and corresponding display colors for mapping.



1. Press CONFIGURATION side tab .
2. Press **Product**.
3. Select:
  - ▶ Color Range – mode used to set the rate for Maximum Rate Color and Minimum Rate Color.
    - ◀ Automatic – maximum and minimum will be determined by actual applied rate values or target rate values
    - ◀ Manual – maximum and minimum limits will be set to those set in Applied Rate Mapping Upper Limit and Applied Rate Mapping Lower Limit options
  - ▶ Maximum Rate Color – used to set the color for the maximum rate. When in Manual Color Range mode, this color will be used for all rates above the Applied Rate Mapping Upper Limit
  - ▶ Minimum Rate Color – used to set the color for the minimum rate. When in Manual Color Range mode, this color will be used for all rates below the Applied Rate Mapping Lower Limit

Figure 8-10: Product Options





## Target Rate Map

 Target Rate Map shows the target application rate that the rate controller attempted to achieve at each location.

*NOTE: Application Map and Target Rate Map cannot be selected simultaneously.*

### On Screen Mapping

- Coverage Area – illustrates applied area:
  - ◀ User Selected – applied areas show colored bars relative to selected color range and map selection.

Figure 8-11: Target Rate Map

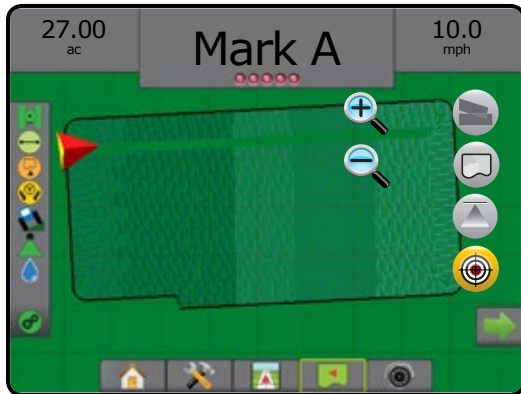

### Target Rates

Preset Target Application Rates define target rates of product being applied per hectare/acre. These settings will set the same for all active jobs.

## Color Range Selection

Product options configure maximum/minimum rate limits and corresponding display colors for mapping.

- Press CONFIGURATION side tab .
- Press **Product**.
- Select:
  - ▶ Color Range – mode used to set the rate for Maximum Rate Color and Minimum Rate Color.
    - ◀ Automatic – maximum and minimum will be determined by actual applied rate values or target rate values
    - ◀ Manual – maximum and minimum limits will be set to those set in Applied Rate Mapping Upper Limit and Applied Rate Mapping Lower Limit options
  - ▶ Maximum Rate Color – used to set the color for the maximum rate. When in Manual Color Range mode, this color will be used for all rates above the Applied Rate Mapping Upper Limit
  - ▶ Minimum Rate Color – used to set the color for the minimum rate. When in Manual Color Range mode, this color will be used for all rates below the Applied Rate Mapping Lower Limit

Figure 8-12: Product Options



## APPENDIX A – SYSTEM CONFIGURATIONS

The following diagrams are reflective of typical Matrix Pro GS configurations. Due to the variety of possible configurations, this should be used for reference purposes only.

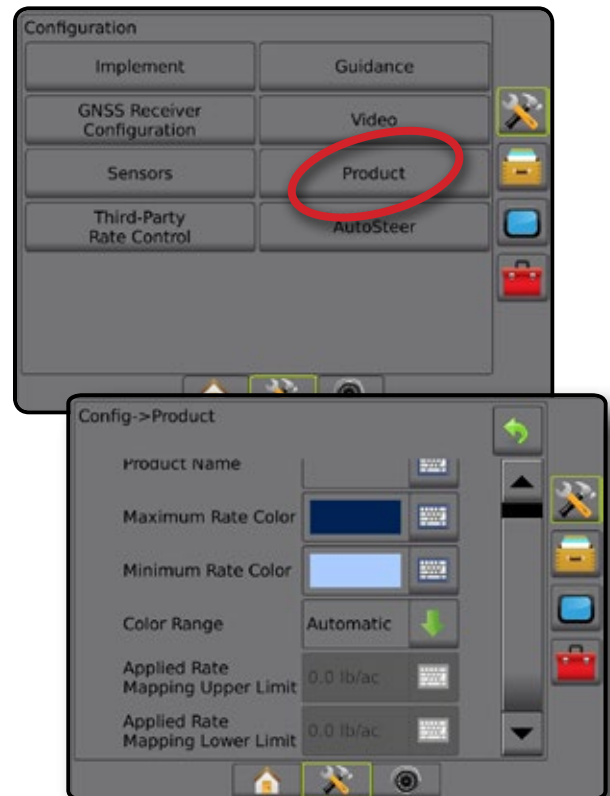
Figure A-1: Matrix Pro GS with FieldPilot AutoSteering System

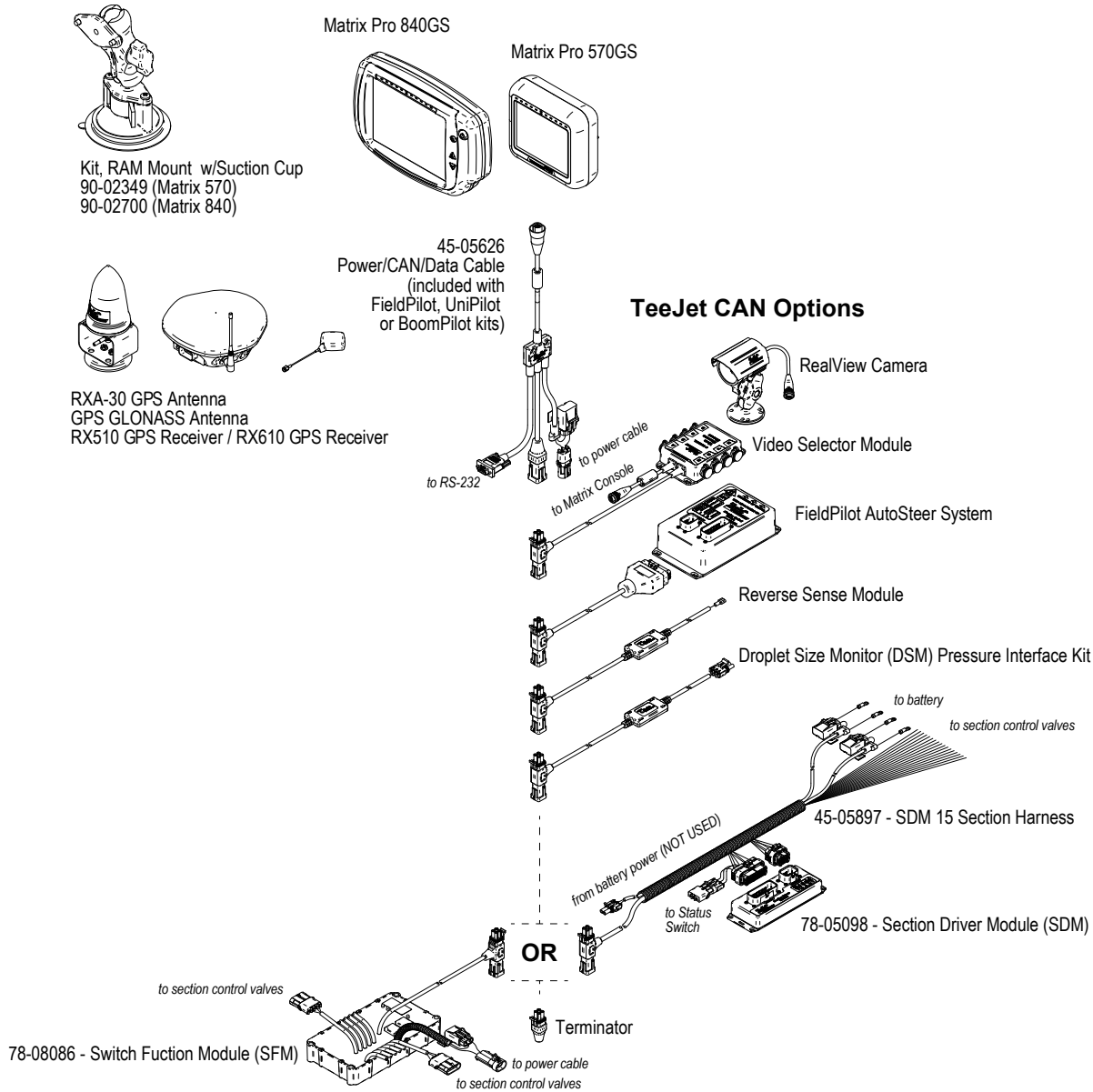
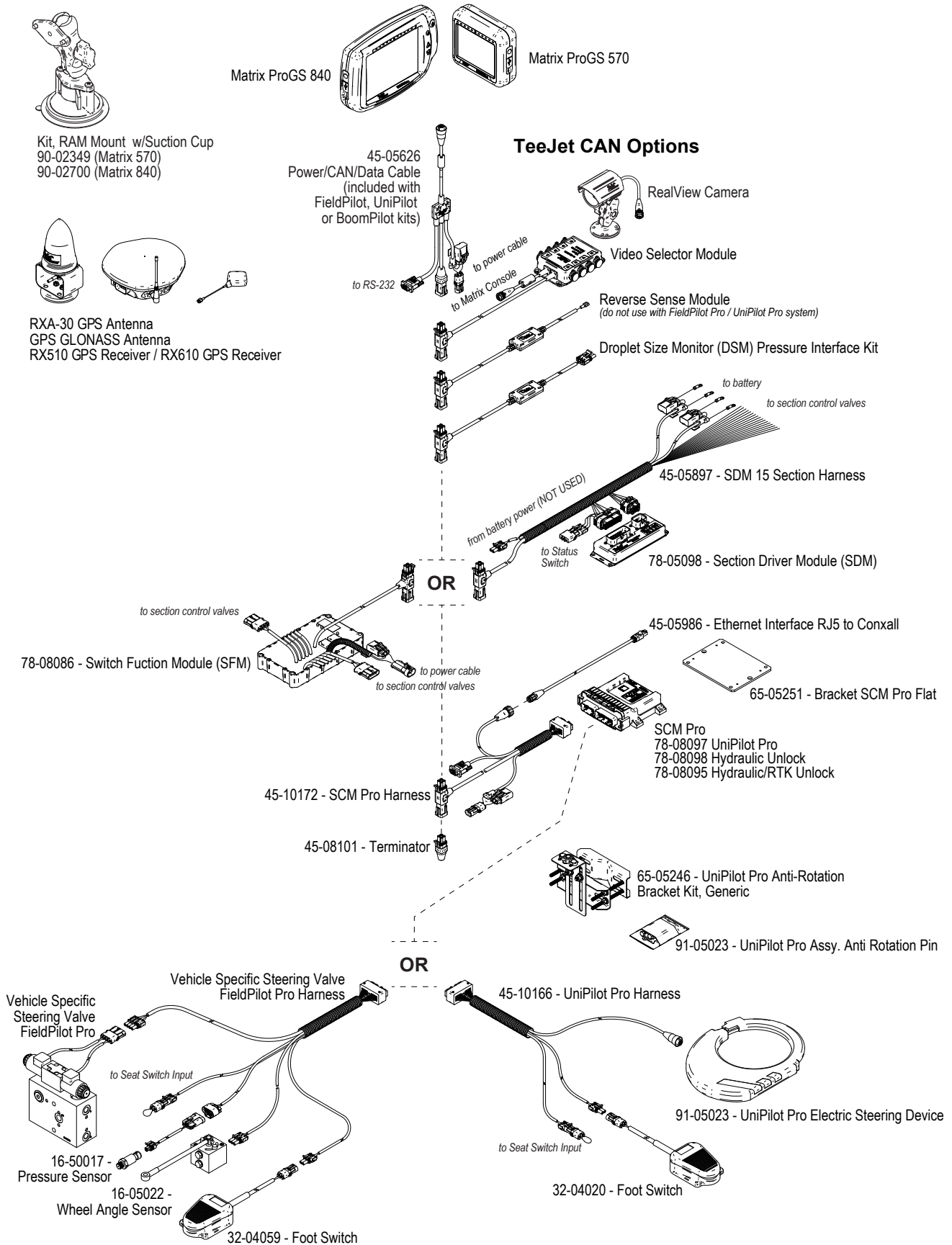

Figure A-2: Matrix Pro GS with FieldPilot Pro or UniPilot Pro Steering System



## APPENDIX B – MATRIX PRO GS CONSOLE MENU SETTINGS

This appendix lists the Matrix Pro GS console’s menu settings, and also provides the following:

- Settings available with an active job.
- Settings that can be made in the Matrix Pro GS console itself, or using the Fieldware Link software.
- Settings that are included when exported to a profile from the Matrix Pro GS console, or from Fieldware Link.

### Symbol Key

In the following tables, these symbols indicate whether settings are available during an active job:

- ✓ Available during an active job
- ✗ Not Available during an active job

### Configuration Settings

Configuration Settings		Available with Active Job	Can be edited in		Saved to exported profile in		
			Matrix Pro	Fieldware Link	Matrix Pro	Fieldware Link	
	Machine Type .....	✗	✓	✓	✓	✓	
	GNSS Antenna Height.....	✗	✓	✓	✓	✓	
	Implement Type.....	✗	✓	✓	✓	✓	
	Symmetric Implement Layout.....	✗	✓	✓	✓	✓	
	Number of Implement Sections .....	✗	✓	✓	✓	✓	
	Guidance Width.....	✗	✓	✓	✓	✓	
	Application/Working Width.....	✗	✓	✓	✓	✓	
	Droplet Size Monitor.....	✓	✓	✓	✓	✓	
	Tip Selection .....	✓	✓	✓	✓	✓	
	Applied Alert .....	✓	✓	✓	✓	✓	
	Entry Time .....	✓	✓	✓	✓	✓	
	Exit Time.....	✓	✓	✓	✓	✓	
	Allow BoomPilot In Reverse .....	✓	✓	✓	✓	✓	
	BoomPilot Start Mode.....	✓	✓	✓	✓	✓	
	BoomPilot Icon .....	✓	✓	✓	✓	✓	
	Reverse Signal Delay .....	✓	✓	✓	✓	✓	
Implement	Straight Mode	In-line Implement Offset Direction .....	✗	✓	✓	✓	✓
		In-line Implement Offset Distance .....	✗	✓	✓	✓	✓
		Lateral Implement Offset Direction .....	✗	✓	✓	✓	✓
		Lateral Implement Offset Distance .....	✗	✓	✓	✓	✓
		Overlap .....	✓	✓	✓	✓	✓
		Delay On/Off Times .....	✓	✓	✓	✓	✓
Spreader Mode	<b>Setup Type: TeeJet</b>		✗	✓	✓	✓	✓
	Antenna to Disks Distance .....	✗	✓	✓	✓	✓	
	Lateral Implement Offset Direction .....	✗	✓	✓	✓	✓	
	Lateral Implement Offset Distance .....	✗	✓	✓	✓	✓	
	Overlap .....	✓	✓	✓	✓	✓	
	Delay On/Off Times .....	✓	✓	✓	✓	✓	
	Spread Offset Distance .....	✗	✓	✓	✓	✓	
	Section Offsets .....	✗	✓	✓	✓	✓	
Section Lengths.....	✗	✓	✓	✓	✓		
Implement (continued)	Staggered Mode	<b>Setup Type: OEM</b>		✗	✓	✓	✓
		Antenna to Disks Distance .....	✗	✓	✓	✓	✓
		Lateral Implement Offset Direction .....	✗	✓	✓	✓	✓
		Lateral Implement Offset Distance .....	✗	✓	✓	✓	✓
		Start/Stop Distances.....	✗	✓	✓	✓	✓
		Section Start/Stop Offsets .....	✗	✓	✓	✓	✓
		In-line Section 1 Offset Direction .....	✗	✓	✓	✓	✓
		In-line Section 1 Offset Distance .....	✗	✓	✓	✓	✓
		Lateral Implement Offset Direction .....	✗	✓	✓	✓	✓
		Lateral Implement Offset Distance .....	✗	✓	✓	✓	✓
Overlap .....	✓	✓	✓	✓	✓		
Delay On/Off Times .....	✓	✓	✓	✓	✓		
Section Offsets .....	✗	✓	✓	✓	✓		

Configuration Settings		Available with Active Job	Can be edited in		Saved to exported profile in		
			Matrix Pro	Fieldware Link	Matrix Pro	Fieldware Link	
Guidance	LED Brightness.....	✓	✓	✗	✗	✗	
	Display Mode.....	✓	✓	✗	✗	✗	
	LED Spacing.....	✓	✓	✗	✗	✗	
	External Lightbar .....	✓	✓	✗	✗	✗	
	External Lightbar LED Brightness .....	✓	✓	✗	✗	✗	
	External Lightbar Text Brightness .....	✓	✓	✗	✗	✗	
	External Cross Track .....	✓	✓	✗	✗	✗	
	External Swath Number.....	✓	✓	✗	✗	✗	
	External Speed.....	✓	✓	✗	✗	✗	
	External Actual Rate.....	✓	✓	✗	✗	✗	
	External Target Rate.....	✓	✓	✗	✗	✗	
External Applied Product .....	✓	✓	✗	✗	✗		
GNSS Receiver Configuration	GNSS Type.....	✗	✓	Reference Only	✓	Retained from console	
	GNSS Port.....	✗	✓		✓		
	GNSS Status Information .....	✓	✓		✓		
	Program.....	✗	✓		✓		
	PRN.....	✗	✓		✓		
Video	Reverse/Inverse .....	✓	✓	✓	✓	✓	
Sensors	Input Output Module (IOM) Pressure Sensor	Maximum Pressure Rating .....	✓	✓	✓	✓	
		Low Pressure Alarm .....	✓	✓	✓	✓	
		High Pressure Alarm.....	✓	✓	✓	✓	
Product*	Product Name.....	✗	✓	✓	✓	✓	
	Maximum Rate Color.....	✓	✓	✓	✓	✓	
	Minimum Rate Color.....	✓	✓	✓	✓	✓	
	Color Range .....	✓	✓	✓	✓	✓	
	Applied Rate Mapping Upper Limit.....	✗	✓	✓	✓	✓	
Applied Rate Mapping Lower Limit.....	✗	✓	✓	✓	✓		
Third-Party Rate Control*	Enable/Disable .....	✗	✓	✗	✗	✗	
	Hardware Interface.....	✗	✓	✗	✗	✗	
	Communication Protocol .....	✗	✓	✗	✗	✗	
	Controller Mode .....	✗	✓	✗	✗	✗	
	Serial Baud Rate .....	✗	✓	✗	✗	✗	
Rate Controller Status .....	✓	✓	✗	✗	✗		
AutoSteer with FieldPilot Pro or UniPilot Pro	Manage Vehicles	New .....	✗	✓	✗	✗	✗
		Load.....	✗	✓	✗	✗	✗
		Edit .....	✗	✓	✗	✗	✗
		Copy .....	✗	✓	✗	✗	✗
		Auto Calibration .....	✗	✓	✗	✗	✗
		Adjust.....	✓	✓	✗	✗	✗
	Adjust	Delete .....	✗	✓	✗	✗	✗
		Manual Disengage.....	✗	✓	✗	✗	✗
		Motor Aggressiveness .....	✓	✓	✗	✗	✗
		UniPilot Pro Freeplay.....	✓	✓	✗	✗	✗
		Steering Response .....	✓	✓	✗	✗	✗
		Heading Aggressiveness .....	✓	✓	✗	✗	✗
		Cross Track Error .....	✓	✓	✗	✗	✗
		Line Acquisition.....	✓	✓	✗	✗	✗
	Reverse Response.....	✓	✓	✗	✗	✗	
Tilt Calibration.....	✗	✓	✗	✗	✗		
Wheel Angle Sensor (WAS) Calibration .....	✗	✓	✗	✗	✗		
Select QI Values .....	✓	✓	✗	✗	✗		
Maximum DOP .....	✓	✓	✗	✗	✗		
Transport Mode .....	✓	✓	✗	✗	✗		
Service Mode.....	✓	✓	✗	✗	✗		
Operator Presence .....	✓	✓	✗	✗	✗		



Configuration Settings		Available with Active Job	Can be edited in		Saved to exported profile in		
			Matrix Pro	Fieldware Link	Matrix Pro	Fieldware Link	
AutoSteer	Assisted/Auto Steering Enabled/Disabled .....	✓	✓	✗	✓	Retained from console	
	Valve Setup	Valve Type .....	✗	✓	✗	✓	Retained from console
		Valve Frequency .....	✗	✓	✗	✓	
		Minimum Left/Right Duty Cycle .....	✗	✓	✗	✓	
		Maximum Left/Right Duty Cycle .....	✗	✓	✗	✓	
	Steering Settings	Coarse Steering Adjustment .....	✓	✓	✗	✓	Retained from console
		Fine Steering Adjustment .....	✓	✓	✗	✓	
		Deadband .....	✓	✓	✗	✓	
		Lookahead .....	✓	✓	✗	✓	
		Valve Test .....	✗	✓	✗	✓	Retained from console
		Valve Diagnostics .....	✗	✓	✗	✓	Retained from console
	Options	Steering Wheel Sensor .....	✗	✓	✗	✓	Retained from console
	Steering Angle Sensor	Enabled/Disabled .....	✗	✓	✗	✓	Retained from console
		Sensor Calibration .....	✓	✓	✗	✓	
		On Line Calibration .....	✓	✓	✗	✓	
Tilt Correction	Enabled/Disabled .....	✗	✓	✗	✓	Retained from console	
	Field Level .....	✗	✓	✗	✓	Retained from console	

\*Available only with an active Third-Party Rate Controller on the system.

## Data Management Settings

Data Management Settings		Available with Active Job	
Job Data	Transfer	Export .....	✗
		Import .....	✗
		Delete .....	✗
	Manage	Export .....	✗
		Import .....	✗
		Delete .....	✗
Reports	Save PDF .....	✗	
	Save KML .....	✗	
	Save SHP .....	✗	
	Save all types .....	✗	
Options	Job Mode .....	✗	
Machine Settings	Transfer	Export .....	✓
		Import .....	✓
		Delete .....	✓
	Manage	New .....	✓
		Copy .....	✓
		Delete .....	✓
		Save .....	✓
		Load .....	✗

## Console Settings

Console Settings		Available with Active Job
About	System Information.....	✓
	Save .....	✓
Display	Color Scheme.....	✓
	LCD Brightness .....	✓
	Screenshot .....	✓
	Screen Calibration .....	✓
Cultural	Units .....	✓
	Language.....	✓
	Time Zone .....	✓
Audio Volume	Audio Volume .....	✓
Demo GNSS	Start.....	✓
Feature Unlock	BoomPilot for Spreader .....	
	Third-Party Rate Controll.....	✓
	FieldPilot Pro / UniPilot Pro .....	

## Tools Settings

Tools Settings		Available with Active Job
Upload Software	Device.....	✓
	Software .....	✓
Extras	Calculator .....	✓
	Units Converter.....	✓

## APPENDIX C – UNIT SPECIFICATIONS

Dimensions	Matrix Pro 570GS	16.15 x 14.91 x 5.84 cm
	Matrix Pro 840GS	27.0 x 18.0 x 6.0 cm
Weight	Matrix Pro 570GS	0.794 kg
	Matrix Pro 840GS	1.06 kg
Connector	Power/CAN	8 pin Conxall
	Camera	5 pin Conxall
	Speed/Status	8 pin Conxall
<i>WARNING! Some original Matrix consoles have a 4 pin conxall cable connection. The 4-pin and 8-pin cables are NOT interchangeable.</i>		
Environmental	Storage	-10 to +70°C
	Operating	0 to +50°C
	Humidity	90% non-condensing
Display	Matrix Pro 570GS	320 x 240 resolution, 14.5 cm
	Matrix Pro 840GS	800 x 600 resolution, 21.3 cm
Input/output	USB 2.0	
Power requirement	< 9 watts @ 12 VDC	

## APPENDIX D – SETTING RANGES

Press the option's name of any menu item to display a definition and range values of that item.

Figure A-3: Example of Information Text Box



## APPENDIX E – UTM COORDINATES AND ZONES

The Matrix® Pro 570GS and Matrix® Pro 840GS use the Universal Transverse Mercator (UTM) coordinate system to track job locations. The UTM coordinate system divides the surface of the Earth into sixty numbered north-south zones, which are further divided into latitude zones designated by letters, as shown below.

Figure A-4: UTM Coordinate System – Global

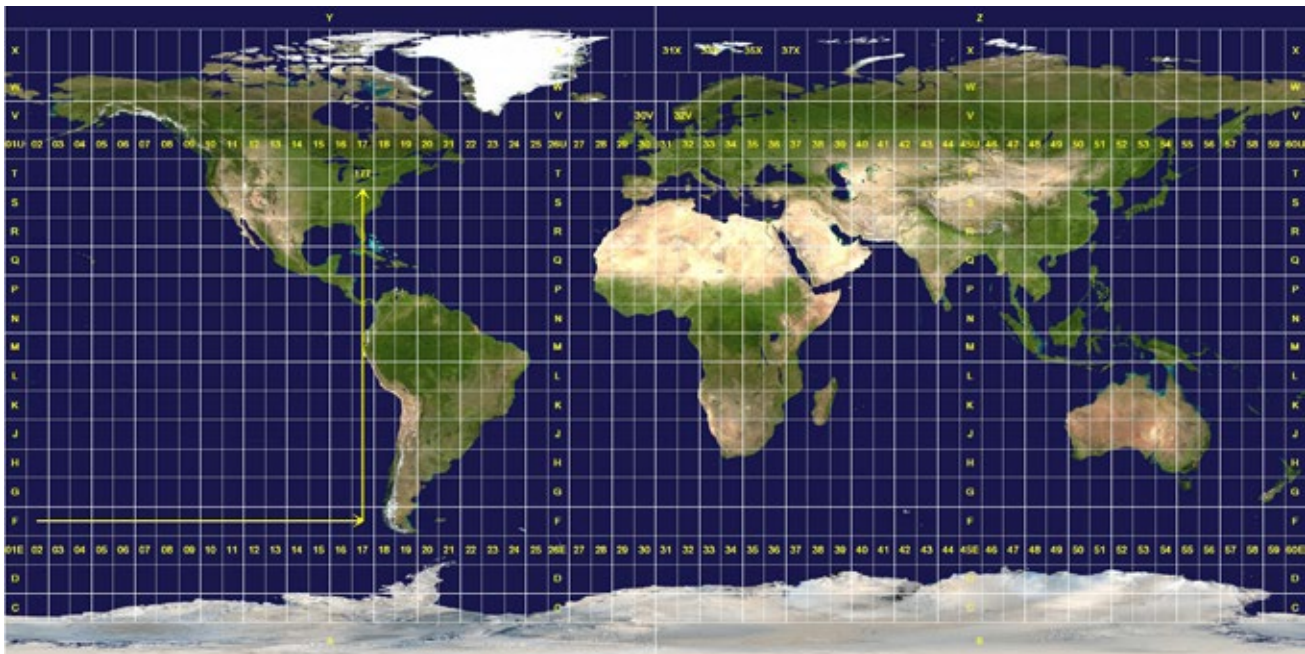

The Matrix Pro GS console then tracks the UTM zones in which each product application job is performed. This zone information is then used to determine whether a job can be started/continued or to find the saved job that is closest to the vehicle's current position.

If a selected job is in a UTM zone other than the current or adjacent UTM zone, "Out of Range" will be displayed next to Distance, and **Start Job** or **Continue** will be disabled.

If a selected job has no recorded information, Distance will show "No Data".

## Copyrights

© 2016 TeeJet Technologies. All rights reserved. No part of this document or the computer programs described in it may be reproduced, copied, photocopied, translated, or reduced in any form or by any means, electronic or machine readable, recording or otherwise, without prior written consent from TeeJet Technologies.

## Trademarks

Unless otherwise noted, all other brand or product names are trademarks or registered trademarks of their respective companies or organizations.

## Limitation of Liability

TEEJET TECHNOLOGIES PROVIDES THIS MATERIAL "AS IS" WITHOUT WARRANTY OF ANY KIND, EITHER EXPRESSED OR IMPLIED. NO COPYRIGHT LIABILITY OR PATENT IS ASSUMED. IN NO EVENT SHALL TEEJET TECHNOLOGIES BE LIABLE FOR ANY LOSS OF BUSINESS, LOSS OF PROFIT, LOSS OF USE OR DATA, INTERRUPTION OF BUSINESS, OR FOR INDIRECT, SPECIAL, INCIDENTAL, OR CONSEQUENTIAL DAMAGES OF ANY KIND, EVEN IF TEEJET TECHNOLOGIES HAS BEEN ADVISED OF SUCH DAMAGES ARISING FROM TEEJET TECHNOLOGIES SOFTWARE.



## Safety Information

TeeJet Technologies is not responsible for damage or physical harm caused by failure to adhere to the following safety requirements.

As the operator of the vehicle, you are responsible for its safe operation.

The Matrix Pro GS in combination with any assisted/auto steering device is not designed to replace the vehicle's operator.

Do not leave a vehicle while the Matrix Pro GS is engaged.

Be sure that the area around the vehicle is clear of people and obstacles before and during engagement.

The Matrix Pro GS is designed to support and improve efficiency while working in the field. The driver has full responsibility for the quality and work related results.

Disengage or remove any assisted/auto steering device before operating on public roads.

# MATRIX<sup>®</sup> PRO GS

## U S E R M A N U A L

---

### Product Upgrades Available

- FieldPilot<sup>®</sup> auto steering
- UniPilot<sup>®</sup> assisted steering
- BoomPilot<sup>®</sup> automated boom section control
- Tilt gyro module
- Video selection modules for up to 8 cameras
- External GPS receiver or antenna upgrades
- Fieldware<sup>®</sup> Link enhanced data organization application
- Pressure sensor kit for droplet size monitor
- Third Party Rate Control



[www.teejet.com](http://www.teejet.com)

A Subsidiary of  *Spraying Systems Co.*<sup>®</sup>

98-05273-ENUS-LT R6 English-US  
© TeeJet Technologies 2016