

IC18 SPRAYER JOB COMPUTER USER MANUAL

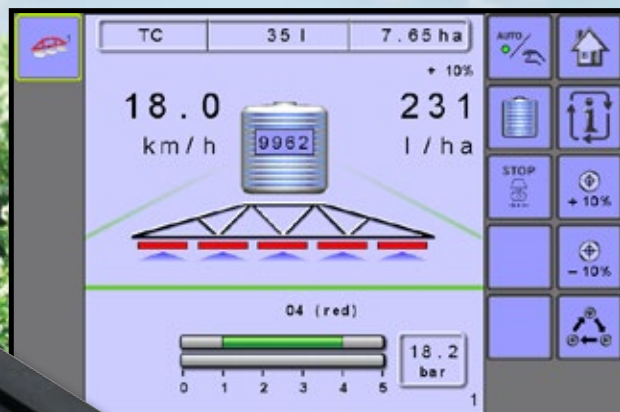

Software version 1.09



A Subsidiary of  Spraying Systems Co.

COPYRIGHTS

© 2017 TeeJet Technologies. All rights reserved. No part of this document or the computer programmes described in it may be reproduced, copied, photocopied, translated, or reduced in any form or by any means, electronic or machine readable, recording or otherwise, without prior written consent from TeeJet Technologies.

TRADEMARKS

Unless otherwise noted, all other brand or product names are trademarks or registered trademarks of their respective companies or organisations.

LIMITATION OF LIABILITY

TEEJET TECHNOLOGIES PROVIDES THIS MATERIAL "AS IS" WITHOUT WARRANTY OF ANY KIND, EITHER EXPRESSED OR IMPLIED. NO COPYRIGHT LIABILITY OR PATENT IS ASSUMED. IN NO EVENT SHALL TEEJET TECHNOLOGIES BE LIABLE FOR ANY LOSS OF BUSINESS, LOSS OF PROFIT, LOSS OF USE OR DATA, INTERRUPTION OF BUSINESS, OR FOR INDIRECT, SPECIAL, INCIDENTAL, OR CONSEQUENTIAL DAMAGES OF ANY KIND, EVEN IF TEEJET TECHNOLOGIES HAS BEEN ADVISED OF SUCH DAMAGES ARISING FROM TEEJET TECHNOLOGIES SOFTWARE.

To ensure optimal use of the equipment, please read this manual thoroughly. Please contact TeeJet Technologies Customer Support or an authorized TeeJet Technologies dealer if additional support is required.

RESPONSIBILITY FOR USE OF THIS PRODUCT

Regarding responsibility for use of this product, we refer to our sales and delivery terms which states:

Product Usage

Any use of the product is at the sole risk of the buyer. The buyer is therefore not entitled to any form for compensation caused by, for example, any of the following:

- ▶ Disturbance to/from any electronic services or products that do not conform to the standards for CE marketing;
- ▶ Missing or poor signal coverage or a succession hereof from external transmitters/receivers used by the buyer; Functional faults which apply to or from a PC-programme or PC equipment not delivered by the seller;
- ▶ Faults that may arise from the buyers' negligence to react to warnings and fault messages from the product or that can be traced to negligence and/or absent constant control of the work carried out in comparison to the planned job.

When implementing any new equipment the buyer must take great care and pay attention. Any doubts as to the correct operation/use should result in contacting the seller's service department.

Table of contents

CHAPTER 1 – INTRODUCTION	1
OPTIONAL SYSTEM COMPONENTS	1
START UP	1
APPLICATION MODE	2
HOME SCREEN	3
MODES	4
Operation mode.....	4
Transport mode.....	5
Main setup mode.....	5
SETTINGS OPTIONS NAVIGATION	6
 CHAPTER 2 – OPERATION MODE	 7
AUTOMATIC OR MANUAL REGULATION MODE	7
OVERVIEW	8
APPLICATION RATE OPTIONS	11
Target Rate	11
Target rate/step percentage increase/decrease	11
Regulation valve manual open/close	11
BOOM SECTIONS	12
Boom section control.....	12
Start/stop application	13
Master valve stop key.....	13
INFORMATION KEY	14
 CHAPTER 3 – MAIN SETUP	 15
COUNTERS	16
Trip counters.....	16
Campaign counters.....	17
Total counters	17
Export counters	17
JOB PARAMETERS	18
MACHINE	19
Filling.....	20
Operation	20
Implement parameters.....	21
Section width	21
Nozzle preset setup (Crop Sprayer or Turf Mode).....	21
Regulation parameters	22
Calibrations.....	23
Implement speed sensor	23
Flow Sensor.....	23
Liquid pressure sensor	24

ISOBUS Job Computer: IC18 Sprayer

INTRODUCTION	Fill flow sensor (Crop Sprayer or Turf Mode).....	25
	Tank level sensor (Crop Sprayer or Turf Mode).....	25
	Alarm configurations.....	27
	OEM	27
USER INTERFACE		28
COMMUNICATION		29
HELP		29
OPERATION	Diagnostic	30
	Test input	30
	Test output	30
	UT data	31
	TECU	31
	About	31
SETTINGS MENU OPTIONS		32
CHAPTER 4 – TRANSPORT MODE		35
SETUP	CHAPTER 5 – OEM OPTIONS	
		36
TRANSPORT	Sensor Presence	37
	Implement Parameters	37
	Implement Geometry	37
	Valve Setup.....	38
	Tank Setup.....	38
	Regulation Details.....	39
Clear Total Counters	40	
APPENDIX A - FACTORY SETTINGS & RANGES		41
APPENDIX B - UNIT SPECIFICATIONS		43
OEM		
APPENDIX		

CHAPTER 1 – INTRODUCTION

Congratulations on the purchase of your new IC18 ECU built on the ISOBUS architecture. This IC18 unit has the capability of either sprayer (crop or turf) or NH3 control when integrated into the implement of either capability. When used within the guidelines of this manual, the IC18 controller will be a reliable application tool.

Use with your existing Universal Terminal (UT)

- Works seamlessly and displays on any ISOBUS UT
- Easy navigation menu and data rich display
- IC18 Sprayer ECU suitable for use with NH3 and liquid fertiliser
- Automatic boom section control upgrade option
- Variable rate control available providing your UT has GNSS and task control capability
- Add additional ISOBUS ECUs as your needs change
- Provides basic rate control
- Standardised plugs, cables and software simplify installation and connectivity and result in true “plug and play” technology. IC18 ECU resides on the implement, reducing hardware in the cab

Figure 1-1: IC18 Job Computer



OPTIONAL SYSTEM COMPONENTS

ISOBUS Switchbox

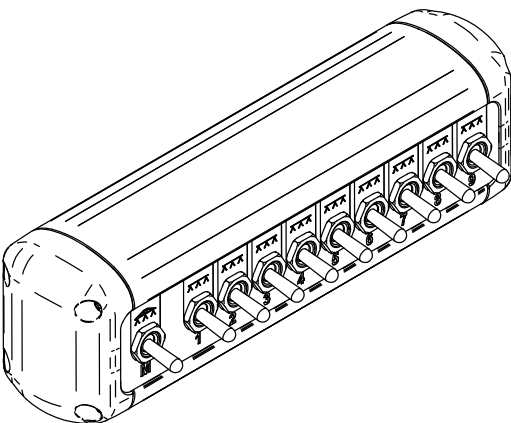

Manual and automatic nine (9) section control with remote master capability and automatic section control when connected to an Aeros console.

Figure 1-2: Switchbox – 9 sections and master output



START UP

Power is continuously supplied to the job computer. The universal terminal (UT) will give access to the job computer options and operation.

- A firm touch is required when selecting a screen icon.
- Settings are NOT automatically saved when selected. The ACCEPT KEY  must be selected to save the setting. Select the ESCAPE KEY  to escape without saving settings and return to the previous menu.
- The console needs to be cycled “off” and back “on” when changing or attaching equipment to the system.
- The menu structure on your display might vary from the one displayed in this User Manual depending on the virtual terminal being used.

ISOBUS Job Computer: IC18 Sprayer

APPLICATION MODE

The IC18 job computer is programmed to be either a crop sprayer, NH3 applicator or turf sprayer. This setting has been established before leaving the factory, but it can be changed after purchase with assistance from TeeJet Technologies Customer Service or your local dealer through the OEM setup menu options.

Figure 1-3: Crop sprayer

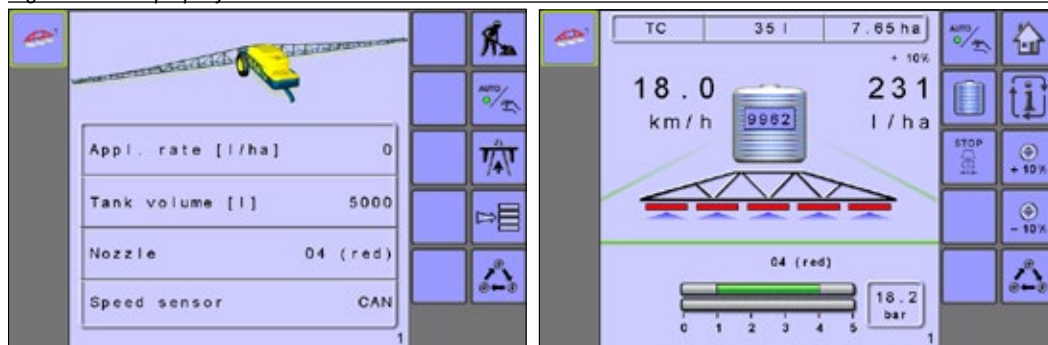

Figure 1-4: NH3 applicator

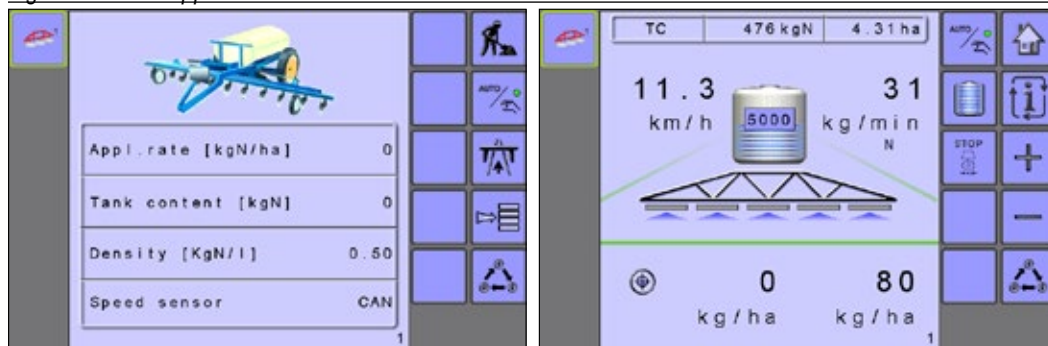
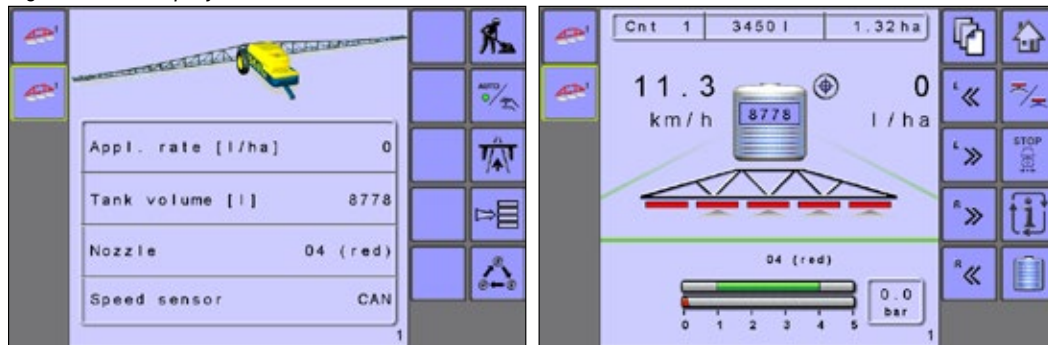

Figure 1-5: Turf sprayer



HOME SCREEN



The Home screen gives access to the IC18's available functions. Power is continuously supplied to the job computer. The universal terminal will give access to the job computer options and operation.

NOTE: Information on the ECU will vary depending on the parameters set by the user and the OEM.

Figure 1-6: Home Screen - NH3 Mode and Sprayer Mode (Crop or Turf sprayer)

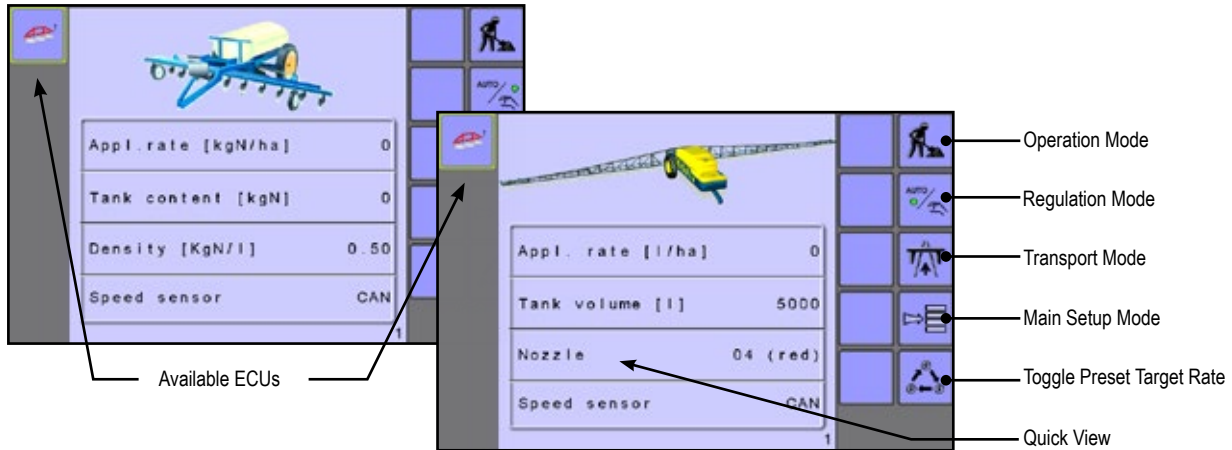







Table 1-1: Home screen functions and descriptions

Function	Description
Available ECUs (image varies depending on systems available)	Systems currently available on your UT are displayed in the left hand column of every page. To navigate between systems simply press the icon to open the desired system.
 Operation mode	Accesses the working aspects of the IC18 Sprayer including boom section control, rate control and trip/count/application information.
 Regulation mode	Switch between automatic or manual regulation modes. A green dot indicates the current selection.
 Transport mode	Locks all spray and hydraulic functions to prevent accidents.
 Main setup menu	Menu to input various spray settings.
 Toggle preset target rate	Shift between entered application rates. NOTE: Preset application rates can be entered in the Job parameters menu.
Quick view	Information displayed is based on the Current active trip and current sprayer mode.

ISOBUS Job Computer: IC18 Sprayer

MODES

Operation mode

Information on the Operation screen will vary depending on the parameters set by the user and the OEM.

Figure 1-7: Operation mode screen overview

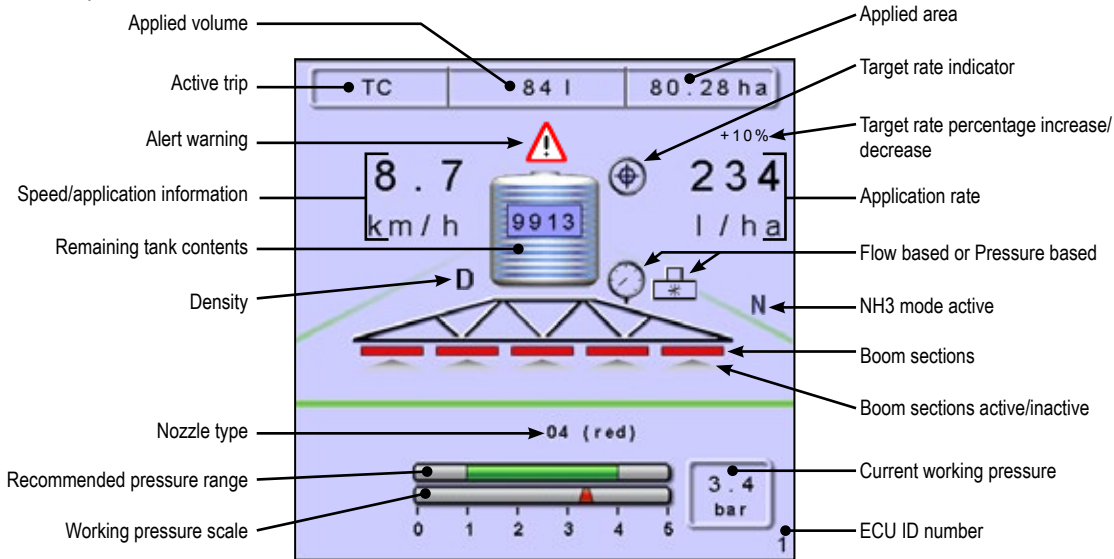

Figure 1-8: Automatic mode - soft key page 1

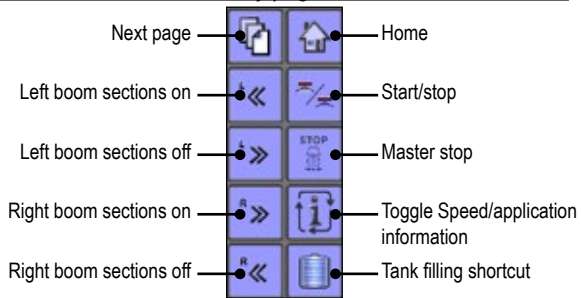

Figure 1-9: Automatic mode - soft key page 2

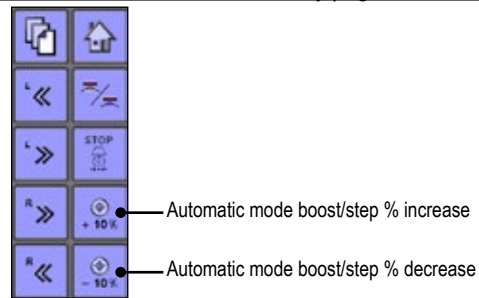
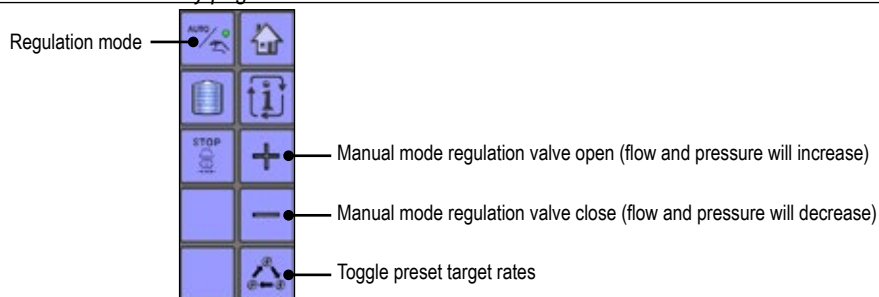

Figure 1-10: Manual mode - soft key page



Transport mode



While in Transport mode, all operation functions are locked “off” and cannot be activated. Transport mode displays the speed in analogue mode.

Figure 1-11: Transport mode

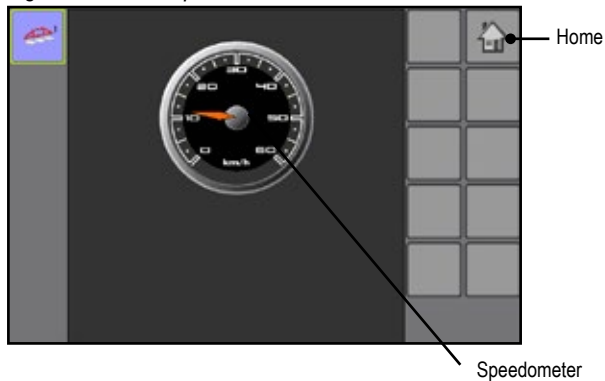

Main setup mode



The main setup menu contains six options. Each of these options either directly access settings or additional menus. The table below outlines the additional menus and directs you to the setup pages for further information.

Figure 1-12: Main setup screen

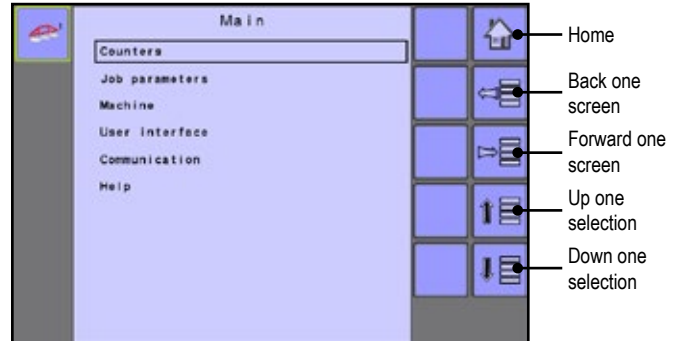

MENU SETUP MODE MENU STRUCTURE

Counters	Job parameters	Machine	User Interface	Communication	Help
▶ Trip		▶ *Filling			▼ Diagnostic
▶ Campaign		▶ Operation			▶ Test input
▶ Total		▼ Implement parameters			▶ Test output
▶ Export		▶ Section width			▶ UT
		▶ Nozzle preset setup			▶ TECU
		▶ Regulation parameters			▶ About
		▼ Calibrations			
		▶ Implement speed sensor			
		▶ *Flow sensor			
		▶ *Liquid pressure sensor			
		▶ *Fill flow sensor			
		▶ *Tank Sensor			
		▶ Alarm Configurations			
		▼ OEM			
		▶ Sensor presence			
		▶ Implement parameters			
		▶ Implement geometry			
		▶ Valve setup			
		▶ Tank setup			
		▶ Regulation details			
		▶ Clear total counters			

The OEM setup menu is password protected and the settings in this menu are directly related to the fitted OEM equipment.

*Menu settings directly related to OEM equipment.

ISOBUS Job Computer: IC18 Sprayer

SETTINGS OPTIONS NAVIGATION

Figure 1-13: Enter Selection Screens

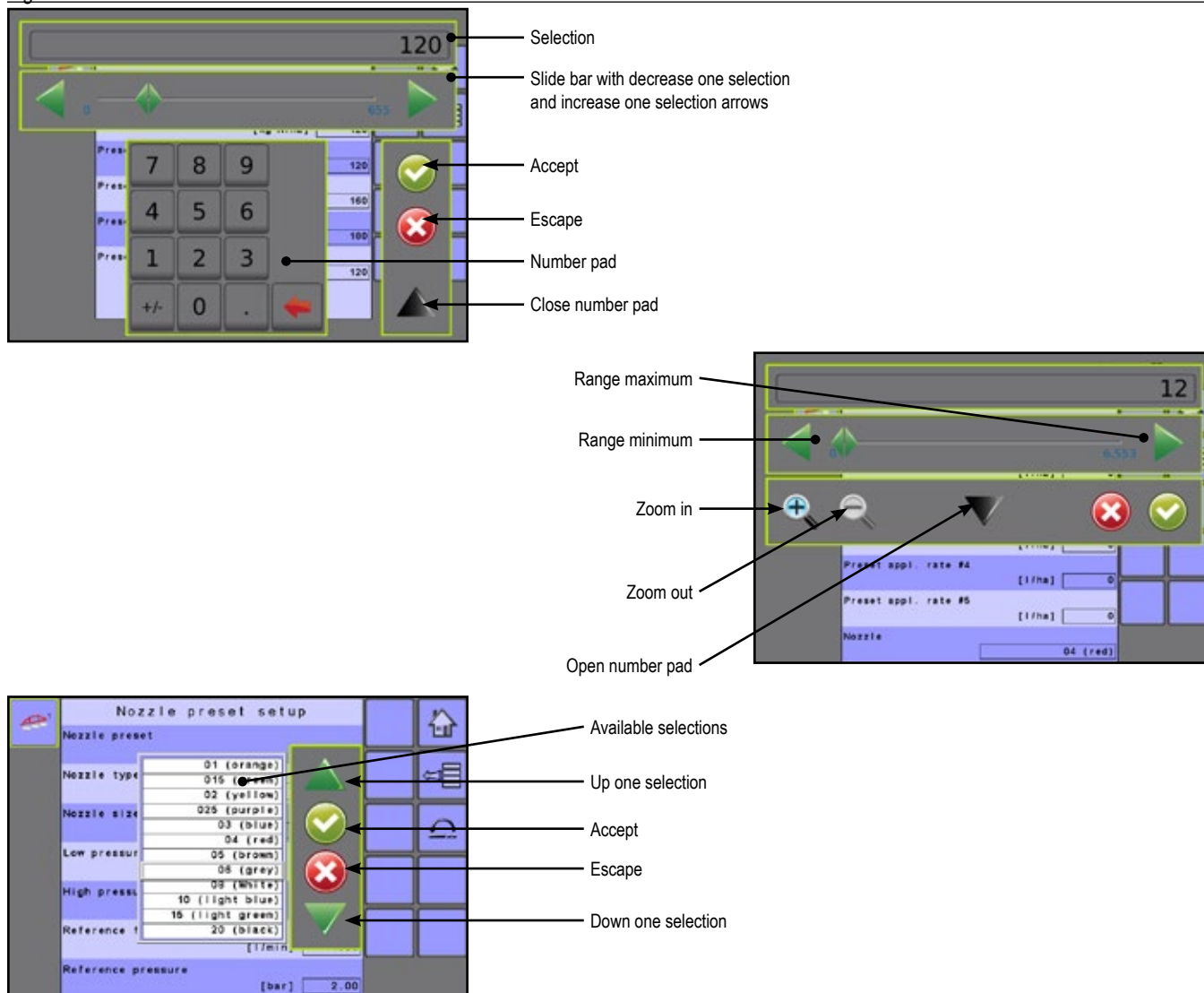

Table 1-2: Section and Icon Descriptions

Section or icon	Description	Section or icon	Description
Selection	Displays the current or new selection	Number pad	Use the numbers to set the selection value
Slide bar	Selects the setting by pressing and releasing on the slide bar or pressing and dragging the slider to a designated value. Range for a specific setting is displayed on the slide bar.	Open number pad ▼	Maximizes the number pad
Slider ◀▶	Slide to the left to decrease or right to increase the selection	Close number pad ▲	Minimizes the number pad
Increase one selection arrow ▶	Increases the setting	Accept key ✓	Accepts the new selection
Decrease one selection arrow ◀	Decreases the setting	Escape key ✕	Escapes without saving changes
		Up one selection arrow ▲	Highlights the selection above
		Down one selection arrow ▼	Highlights the selection below
		Zoom in 🔍+	Narrows slide bar range. Grey = maximum zoom level.
		Zoom out 🔍-	Expands slide bar range. Grey = minimum zoom level.

CHAPTER 2 – OPERATION MODE



The Operation screen accesses the working aspects of the IC18 including boom section control, rate control and trip/count/ application information.

NOTE: Settings are automatically saved when selected.

NOTE: The menu structure on your display might vary from the one displayed in this user manual depending on the UT being used.

AUTOMATIC OR MANUAL REGULATION MODE

There are two types of Regulation mode - Automatic and Manual.

- On the Home screen or Operation screen , establish Automatic operation mode or Manual operation mode by pressing the REGULATION MODE KEY so that the green dot is on auto (automatic) or the hand (manual) accordingly.

Automatic regulation mode

The system will adjust the application rate based on the vehicle speed and active boom width in use for the current the target rate.

- The target rate can be adjusted using the BOOST/STEP % INCREASE/DECREASE KEYS on the Operation screen. Preset application rates define up to three (3) target rates for product being applied per hectare/acre. These can be toggled using the TOGGLE PRESET TARGET RATE KEY on the Operation screen or Home screen.

Manual regulation mode

Retains an established regulation valve setting regardless of speed.

The regulation valve setting can be adjusted using the REGULATION VALVE OPEN/CLOSE KEYS on the Operation screen.

Figure 2-1: Regulation mode key on home screen

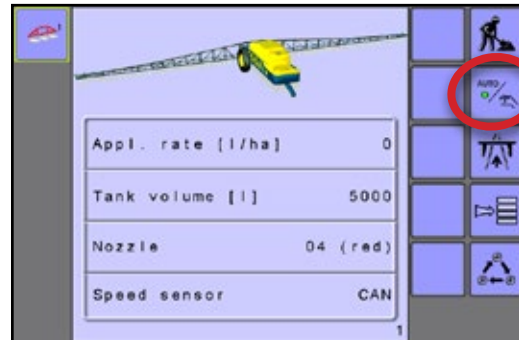
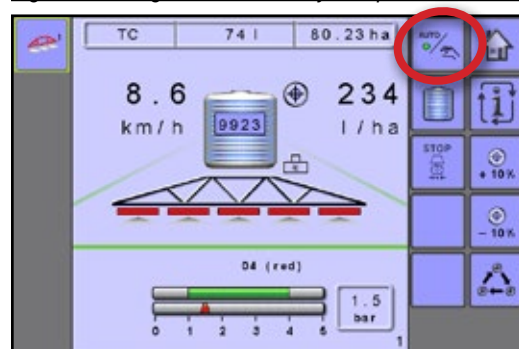

Figure 2-2: Regulation mode key on operation screen



ISOBUS Job Computer: IC18 Sprayer

OVERVIEW

Information on the Operation screen will vary depending on the parameters set by the user and the OEM.

Figure 2-3: Operation mode screen overview

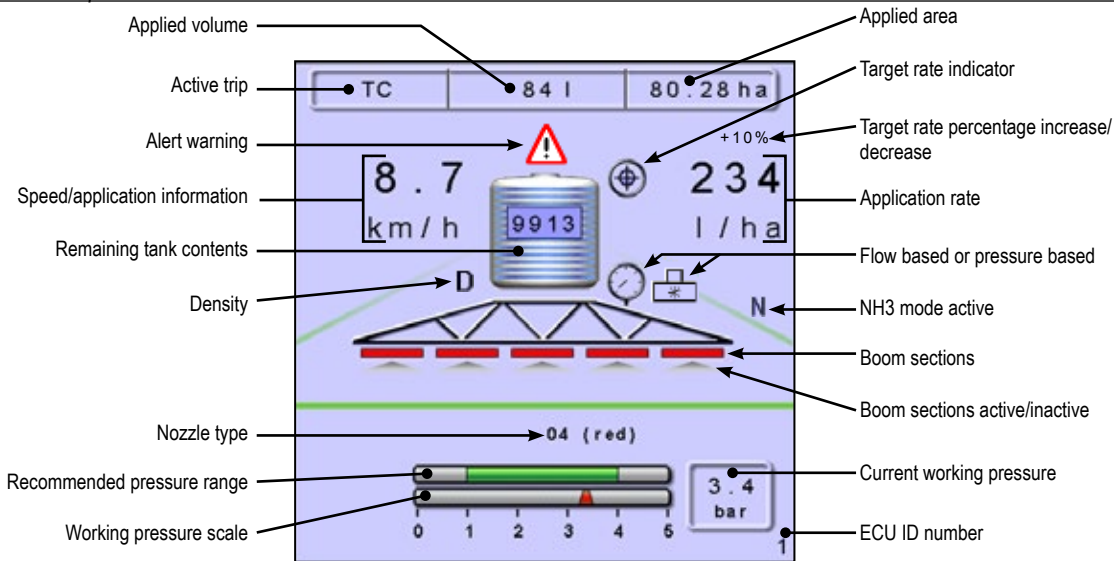

Figure 2-4: Automatic mode - soft key page 1

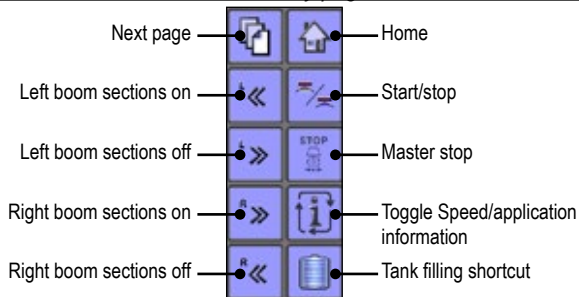

Figure 2-5: Automatic mode - soft key page 2

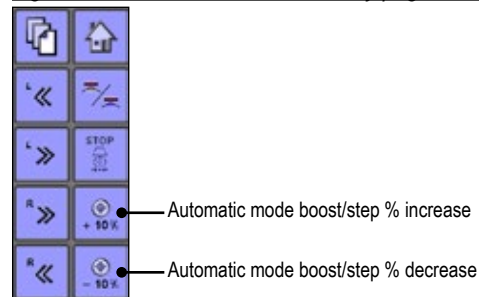
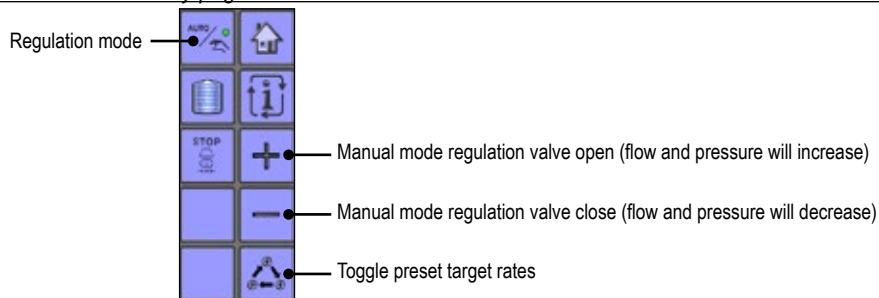

Figure 2-6: Manual mode - soft key page



ISOBUS Job Computer: IC18 Sprayer

Table 2-3: Key/button descriptions























Key/button	Description	Switchbox	
		with	without
	Home Press to return to the Home screen.	✓	✓
	Master valve start/stop Press to start or stop application. Not available if a switchbox is connected.		✓
	Information Press to toggle between display modes.	✓	✓
	Toggle preset target rates Press to toggle between established target application rates. <i>NOTE: Preset application rates can be entered in the Job parameters menu.</i>	✓	✓
	Regulation mode Press to toggle between automatic and manual regulation modes. A green dot indicates the current selection.	✓	
Automatic Regulation Mode automatically adjusts the application rate based on the current speed in reference to the target rate. <i>NOTE: Application rate step percentage can be defined under Main-> Machine-> Operation-> Application Rate Step.</i>			
	Target rate boost/step percent increase	Establish the required boost percentage step, i.e. the step size, at which the application rate is to increase/decrease with the boost function.	
	Target rate boost/step percent decrease	✓	✓
Manual Regulation Mode will retain an established regulation valve setting regardless of speed.			
	Regulation valve manual open - opens the valve to increase pressure.	✓	✓
	Regulation valve manual close - closes the valve to decrease pressure.	✓	✓
	Tank filling shortcut Press for one-press access to the Tank filling setup screen.	✓	✓
	Master stop Press to stop all application, close all regulation valves and change to Manual regulation mode.	✓	✓
	Next page Press to toggle between soft key options.		✓
	Boom sections on/off Press to turn on sections to left  , turn off sections from left  , turn on sections to right  or turn off sections from right  .		✓

Table 2-4: Section and icon descriptions

Section/icon	Description
Active trip information	This information bar displays the Active trip, Applied volume and Applied area 
Active trip	Trip mode – connected to an ISOBUS CAN with only a UT (Universal Terminal) device found, the Current active trip or Job number will be displayed  . TC (Task Controller) mode – connected on an ISOBUS CAN with a TC device found, then TC will be displayed  .
Applied volume	Displays volume applied for the selected active trip.
Applied area	Displays applied area for the selected active trip.
Speed/application information	Displays Vehicle speed or Volume applied per minute or Projected area per hour to be covered or Projected total area remaining to be covered depending upon which view is active. The Information key toggles  between display modes.
Remaining tank contents	Displays the remaining tank content. <i>NOTE: If no tank sensor is fitted or the contents are not entered in the Tank filling menu prior to spraying, tank contents may not display the correct amount.</i> 

ISOBUS Job Computer: IC18 Sprayer

INTRODUCTION











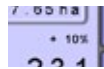





OPERATION

SETUP

TRANSPORT

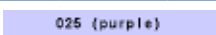
OEM

APPENDIX

Section/icon	Description	
Application rate	Displays the actual application rate per hectare/acre. <i>NOTE: When the master is "on" the actual application rate per hectare/acre will be displayed. When the master is "off" the target rate is displayed and the Target rate icon  appears.</i>	
Target rate boost/step percentage increase/decrease	Displays boost percentage step, i.e. the step size, at which the application rate is to increase/decrease with the boost function.	
Alarm warning	Displayed if an alarm condition is active.	
Flow based or pressure based icons	These symbols will only appear if both a flow sensor and a pressure sensor are installed.	
	Flow based - displayed if a regulation is based on flow.	
	Pressure based - displayed if regulation is based on pressure.	
Density	Displays a "D" to the left of the Tank icon if the density is set to "Fertiliser" instead of water.	
Boom sections	Displays the active  and inactive  boom sections as well as if they are on  (spray is blue) or off  (spray is grey). <i>NOTE: The colour on the boom sections indicates the colour of the Selected nozzle type.</i>	
Circulation	If circulation is installed and selected in the OEM menu, "SC" (semi circulation) or "CC" (full circulation) will be displayed.	
NH3 mode active	Displays if the unit is in NH3 mode.	
Pressure information	This information section displays the nozzle type, recommended pressure range, working pressure scale and current working pressure. <i>NOTE: Nozzle type and recommended pressure are not available in NH3 mode.</i>	
Nozzle type	Displays the selected nozzle type	
Recommended pressure range	Displays the recommended pressure range for the selected nozzle (the green area indicates the pressure range). The pressure range will change depending upon the selected nozzle, working speed, etc. IMPORTANT! ALWAYS REFER TO THE RECOMMENDED PRESSURE RANGE AS FAILURE TO DO SO MAY RESULT IN UNEVEN SPRAY PATTERNS.	
Working pressure scale	Displays the current working pressure <i>NOTE: This pressure range should not exceed the recommended pressure range.</i> IMPORTANT! ALWAYS REFER TO THE RECOMMENDED NOZZLE PRESSURE VALUES WHEN SETTING NOZZLE PRESSURE.	
Current working pressure	Displays the current pressure to the nozzle	
ECU ID number	Displays the soft key number assigned to the displayed IC18 ECU.	

APPLICATION RATE OPTIONS

Target Rate

Preset application rates define up to five (5) target rates of product being applied per hectare/acre. These settings will set the same for all active trips. Target rates set to "0.0" will not be included in the toggle preset target rate options on the Operation screen or Home screen.

With a switchbox

If a switchbox is being used to control the boom sections, current target application rate can be set on the Operation screen.

- To toggle between Target application rates, press the TOGGLE PRESET TARGET RATE KEY .

Figure 2-7: Target application rate



Without a switchbox

When a switchbox is not connected to the system current target application rate needs to be established on the Home screen before entering Operation mode.

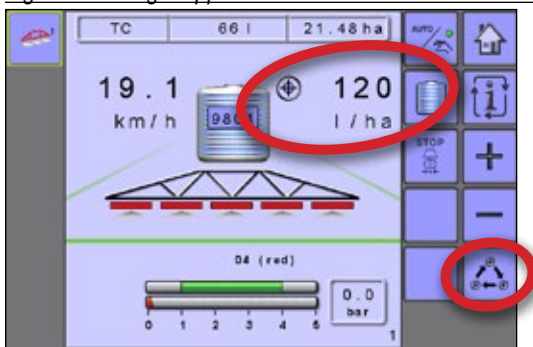
- To toggle between Target application rates, press the TOGGLE PRESET TARGET RATE KEY .

Figure 2-8: Target application rate



Target rate/step percentage increase/decrease

Target rate/step percentage increase/decrease keys adjust the application target rate per the established percentage set in the Machine operation setup screen under Application rate step. Automatic regulation mode will automatically adjust the application rate based on the current speed in reference to the target rate.

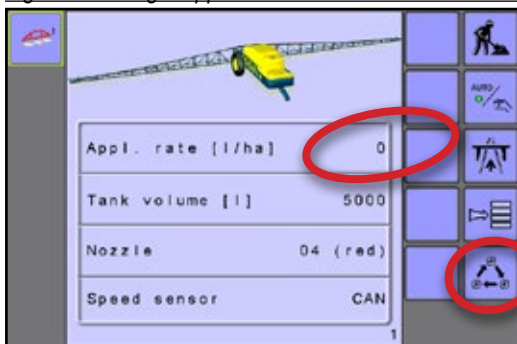
- To adjust the Target rate, press the BOOST/STEP % INCREASE/DECREASE KEYS .

Figure 2-9: Target rate percentage/step increase/decrease



Regulation valve manual open/close

The regulation valve setting can be adjusted using the regulation valve open/close keys on the Operation screen. Manual regulation mode will retain an established regulation valve setting regardless of speed.

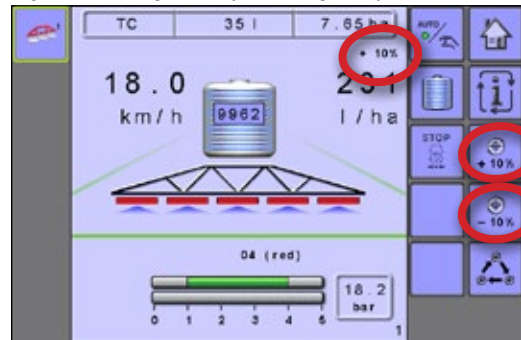
- To adjust the regulation valve, press the REGULATION VALVE OPEN/CLOSE KEYS .

Figure 2-10: Regulation valve manual open/close



ISOBUS Job Computer: IC18 Sprayer

BOOM SECTIONS

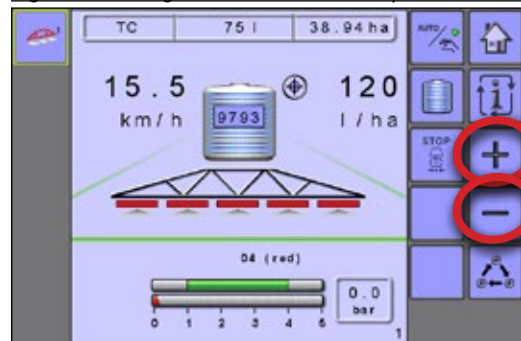
Boom Sections displays the active and inactive boom sections as well as if they are on (spray is blue) or off (spray is grey).

Figure 2-11: Boom sections

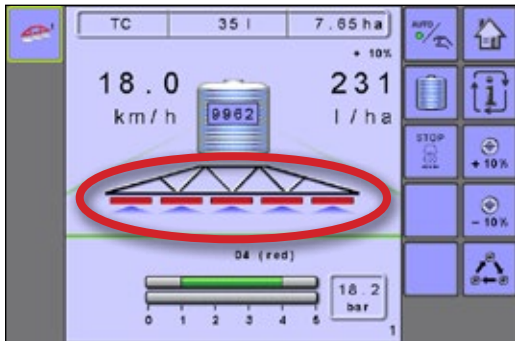

The colour on the boom sections indicates the colour of the selected nozzle type.

Figure 2-12: Nozzle selection chart

Established Nozzle Capacities and Colours			
Size	Colour	Size	Colour
01	Orange	06	Grey
015	Green	08	White
02	Yellow	10	Light Blue
025	Purple	12	Telemagenta
03	Blue	15	Light Green
04	Red	20	Black
05	Brown	30	Beige

Boom section control

Boom section control can be achieved with or without a switchbox.

Figure 2-13: Boom section control

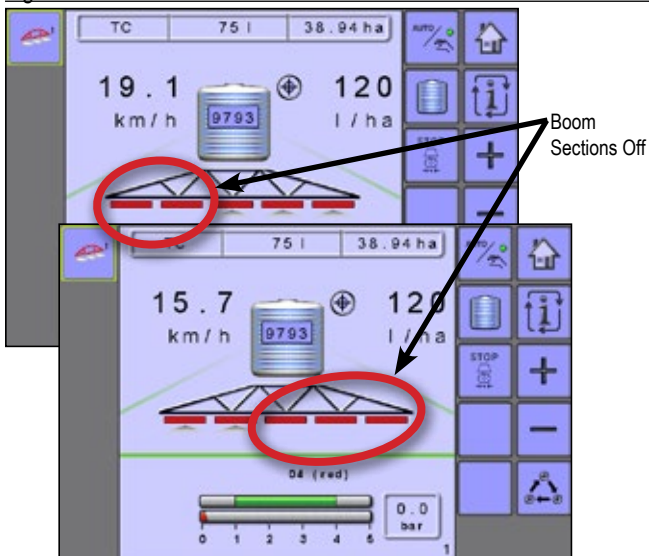

Without a switchbox

When a switchbox is not connected for boom section control, booms sections are controlled using the Boom sections on/off keys.

- To adjust the sections on the left, press the LEFT BOOM SECTIONS ON/OFF KEYS.
- To adjust the sections on the right, press the RIGHT BOOM SECTIONS ON/OFF KEYS.

Figure 2-14: Operations screen – without switchbox

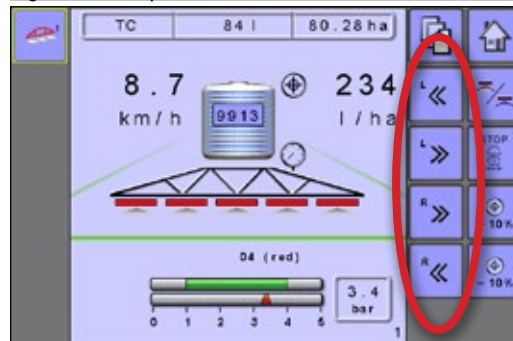

With a switchbox

Boom sections will be controlled by the switchbox if it is connected for boom section control.

Figure 2-15: Operations screen – with switchbox

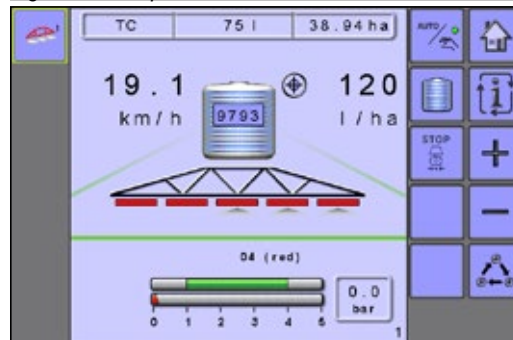

Start/stop application

Starting or stopping application is controlled either by a switchbox or without a switchbox by pressing the start/stop key.

Without a switchbox

If a switchbox is not connected for boom section control, starting/stopping application is controlled pressing the START/STOP APPLICATION KEY .

Figure 2-16: Start/stop key – without a switchbox



With a switchbox

If a switchbox is being used to control the boom sections, starting/stopping application will be controlled by the switchbox.

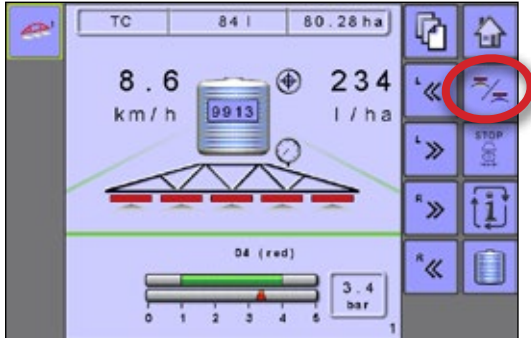
Figure 2-17: Spraying on – with a switchbox

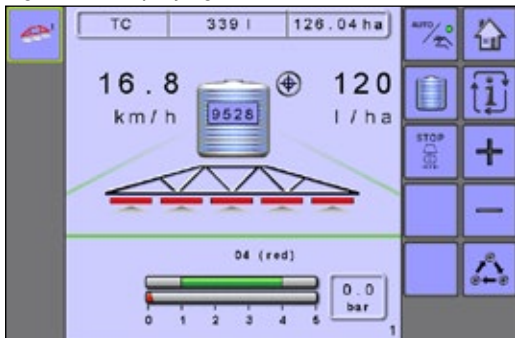

Master valve stop key

The master stop key is intended to be used as an emergency stop key. It will stop all application, close all regulation valves and change to manual regulation mode.

NOTE: The Master stop key may or may not be available depending upon the users configuration.

Without a switchbox

- To stop all application, close all regulation valves and change to manual regulation mode, press the MASTER STOP KEY .

Figure 2-18: Master stop key – without a switchbox



With a switchbox

If a switchbox is being used to control the boom sections, the Master stop key will override the Master switch on the switchbox and turn off any boom application in progress.

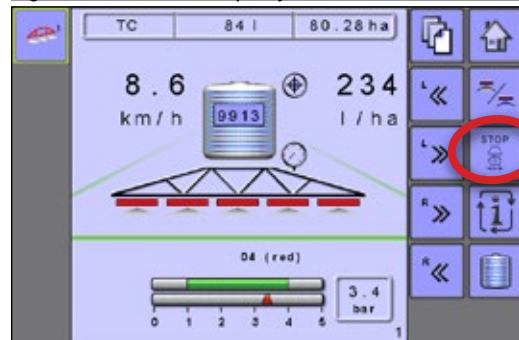
Figure 2-19: Master stop key – with a switchbox

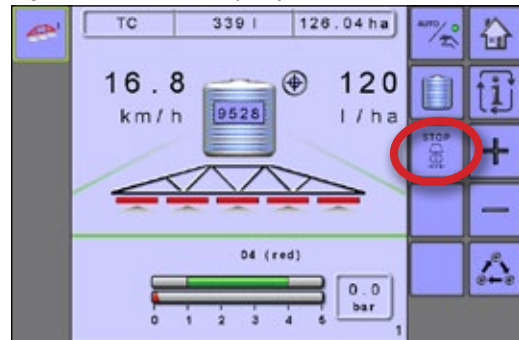

ISOBUS Job Computer: IC18 Sprayer

INFORMATION KEY

The INFORMATION KEY  toggles the Speed/application Information section on the Operation screen between the display modes.

- Vehicle speed
- Volume applied per minute
- Projected area per hour to be covered based on current speed, target rate and tank level
- Projected total area remaining to be covered based on current target rate and current tank level

Figure 2-20: Information Key

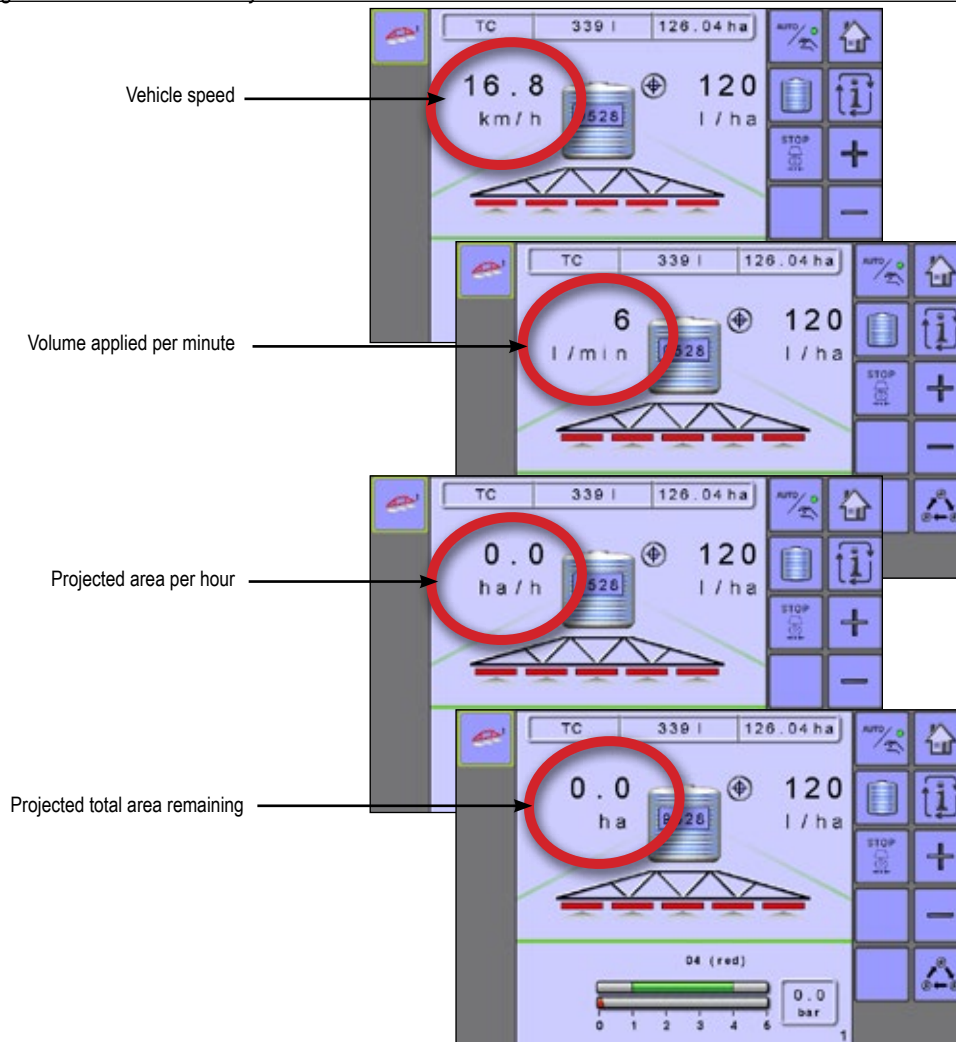

CHAPTER 3 – MAIN SETUP



Main setup mode configures the Counters, Job parameters, Machine, User interface, Communication and Help options.

NOTE: The menu structure on your display might vary from the one displayed in this User Manual depending on the UT being used. This user manual will display all possible options.

MENU SETUP MODE MENU STRUCTURE

Counters	Job parameters	Machine	User interface	Communication	Help
▶ Trip		▶ *Filling			▼ Diagnostic
▶ Campaign		▶ Operation			▶ Test input
▶ Total		▼ Implement parameters			▶ Test output
▶ Export		▶ Section width			▶ UT
		▶ Nozzle preset setup			▶ TECU
		▶ Regulation parameters			▶ About
		▼ Calibrations			
		▶ Implement speed sensor			
		▶ *Flow sensor			
		▶ *Liquid pressure sensor			
		▶ *Fill flow sensor			
		▶ *Tank Sensor			
		▶ Alarm configurations			
		▼ OEM			
		▶ Sensor presence			
		▶ Implement parameters			
		▶ Implement geometry			
		▶ Valve setup			
		▶ Tank setup			
		▶ Regulation details			
		▶ Clear total counters			

The OEM setup menu is password protected and the settings in this menu are directly related to the fitted OEM equipment.

**Menu settings directly related to OEM equipment.*

1. Select MAIN SETUP SCREEN KEY from the Home screen.
2. Select from:
 - ▶ Counters – used to provide an overview of various system counters:
 - ◀ Trip – used to display information regarding area, distance, time and amount applied.
 - ◀ Campaign – used to display information regarding area, amount applied and time for all trips.
 - ◀ Total – used to display information regarding area, amount applied and time for all activity.
 - ◀ Export counters – allows counter information to be exported in HTML or CSV format.
 - ▶ Job parameters – used to configure application settings including active trip counter, application rate and nozzle type.
 - ▶ Machine – used to configure machine settings:
 - ◀ Filling – establishes the amount of material remaining in the tank and the density of that material.
 - ◀ Operation – establishes Application rate step, Speed source and Simulated speed.
 - ◀ Implement parameters – establishes the Section width, Nozzle preset setup and Regulation parameters.
 - ◀ Calibrations – establishes either manual or automatic settings of the sensors.
 - ◀ Alarm configurations – establishes alarms for CAN speed source timeout, Active trip count Information mode and Tank content minimum.
 - ◀ OEM – The OEM setup menu is password protected and the settings in this menu are directly related to the fitted OEM equipment. Refer to the OEM setup chapter for information regarding OEM settings.
 - ▶ User interface – used to allow the operator to select the system universal terminal (UT), switchbox pairing and soft key numbering as well as view serial numbers and ECU identification numbers:

ISOBUS Job Computer: IC18 Sprayer

- ▶ Communication – used to establish the IC18's ability to communicate with an external computer.
- ▶ Help – allows the operator to choose between Diagnostics and the About screen:
 - ◀ Diagnostic – used to troubleshoot input/output of the controller (sensor or actuator).
 - ◀ About – used to provide information on the console such as software version, build number, etc.

Figure 3-1: Main setup screen

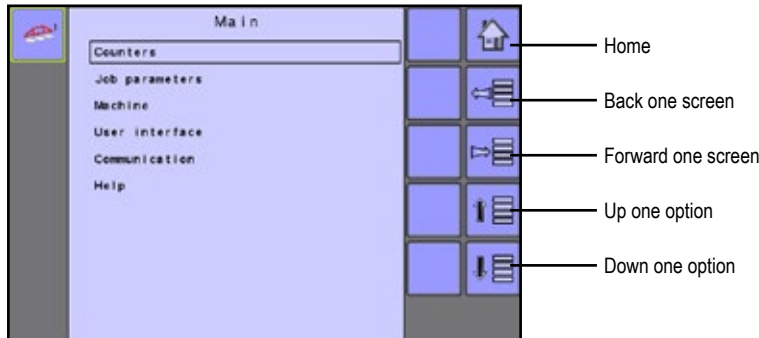

COUNTERS

The Counters Menu provides an overview of various system counters including Trip counters, Campaign counters and Total Counters. From this screen one can also Export counters.

MENU SETUP MODE MENU STRUCTURE

Counters	Job parameters	Machine	User interface	Communication	Help
▶ Trip					
▶ Campaign					
▶ Total					
▶ Export					

1. From the Main setup screen , select COUNTERS.
2. Select from:
 - ▶ Trip – used to display information regarding area, distance, time and amount applied
 - ▶ Campaign – used to display information regarding area, amount applied and time for all trips
 - ▶ Total – used to display information regarding area, amount applied and time for all activity
 - ▶ Export counters – allows counter information to be exported in HTML or CSV format

NOTE: Trip Counters will not be active when using a task controller.

Figure 3-2: Counters

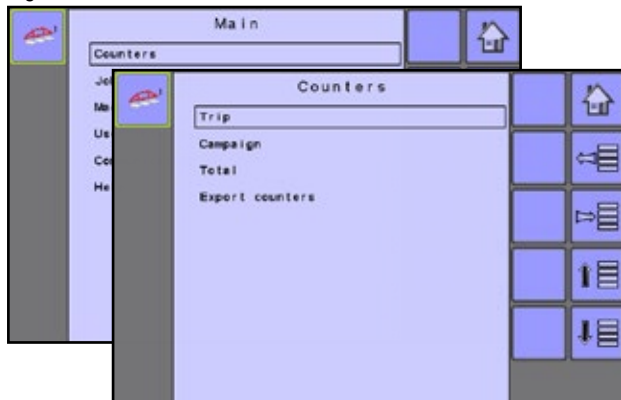

Trip counters

Trip counters displays information regarding area, distance, time and amount applied. The trip that is active is displayed/active on the Operations screen.

Figure 3-3: Trip counters



Active trip counter

One of up to ten (10) Active trip counters can be selected to view the desired trip information. The trip that is “active” is displayed/active on the Operation screen.

- To clear the Trip counters, select RECYCLE BIN KEY . A confirmation screen will be displayed.

Area counter

Displays applied coverage area for the selected Active trip.

Distance counter

Displays distance travelled for the selected Active trip.

Time counter

Displays time travelled for the selected Active trip.

Volume counter

Displays volume of material applied during the selected Active trip.

Campaign counters

Campaign counters display information regarding area, amount applied and time for all trips.

- To clear the Campaign counters, select RECYCLE BIN KEY . A confirmation screen will be displayed.

Figure 3-4: Campaign counters



Area counter

Displays total applied coverage area for all trips.

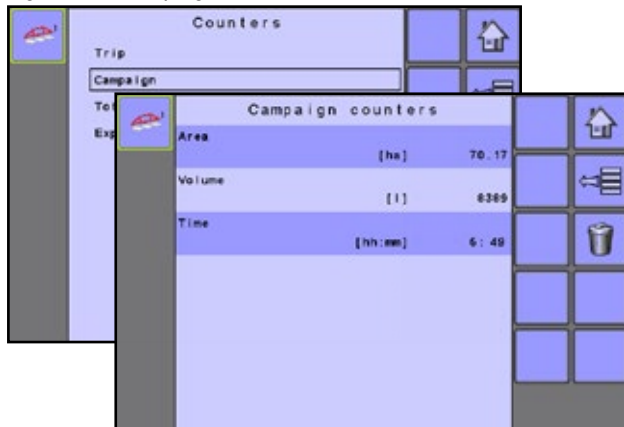
Volume counter

Displays total volume of material applied during all trips.

Time counter

Displays total time travelled for all trips.

Total counters

Total counters displays information regarding area, amount applied and time for all activity. Total counters can only be cleared in the OEM menu.

Figure 3-5: Total counters



Area counter

Displays total applied coverage area for all trips.

Volume counter



Displays total volume of material applied during all trips.

Time counter

Displays total time travelled for all trips.

Export counters

Export counters allows counter information to be exported in HTML or CSV format. HTML files can be viewed from an internet browser. CSV files can be viewed as Excel sheets.

- To export an HTML file, select HTML KEY . A confirmation screen will be displayed.
- To export a CSV file, select CSV KEY . A confirmation screen will be displayed.

For data transfer, an optional cable is required. Contact your local dealer for additional information.

Figure 3-6: Export counters



ISOBUS Job Computer: IC18 Sprayer

JOB PARAMETERS

Job parameters configures application settings. Options include Active trip counter, Preset Application Rates and Nozzle.

MENU SETUP MODE MENU STRUCTURE



1. From the Main setup screen , select JOB PARAMETERS.

Figure 3-7: Job parameters

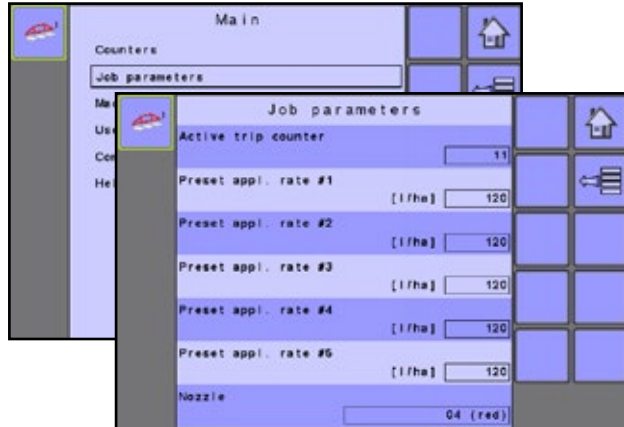

Active trip counter

Active trip counter selects one of up to ten (10) active trip counters to view the desired trip information. The trip that is "active" is displayed/active on the Operation screen.

NOTE: The selected trip counter will have all data modified (added to) when additional operations are activated. If current trip counter is not cleared, the new data will be added to the existing data.

Preset application rates

Preset application rates define up to five (5) target rates of product being applied per hectare/acre. These settings will set the same for all active trips. Target rates set to "0.0" will not be included in the TOGGLE PRESET TARGET RATE options  on the Operation Screen or Home screen.

Nozzle

Nozzle selects the nozzle type. This setting will set the same for all active trips. The five (5) available nozzle types are preset under Main-> Machine-> Implement parameters-> Nozzle preset setup. This setting will set the same for all active trips.

MACHINE

Machine configures machine settings. Options include Filling, Operation, Implement parameters, Calibrations, Alarm configurations and OEM.

MENU SETUP MODE MENU STRUCTURE

Counters	Job parameters	Machine	User interface	Communication	Help
		▶ *Filling			
		▶ Operation			
		▼ Implement parameters			
		▶ Section width			
		▶ Nozzle preset setup			
		▶ Regulation parameters			
		▼ Calibrations			
		▶ Implement speed sensor			
		▶ *Flow sensor			
		▶ *Liquid pressure sensor			
		▶ *Fill flow sensor			
		▶ *Tank Sensor			
		▶ Alarm configurations			
		▼ OEM			
		▶ Sensor presence			
		▶ Implement parameters			
		▶ Implement geometry			
		▶ Valve setup			
		▶ Tank setup			
		▶ Regulation details			
		▶ Clear total counters			

The OEM setup menu is password protected and the settings in this menu are directly related to the fitted OEM equipment.

*Menu settings directly related to OEM equipment.

- From the Main setup screen , select MACHINE.
- Select from:
 - ▶ Filling – establishes the amount of material remaining in the tank and the density of that material.
 - ▶ Operation – establishes Application rate step, Speed source and Simulated Speed.
 - ▶ Implement parameters – establishes the Section Width, Nozzle preset setup and Regulation Parameters.
 - ▶ Calibrations – establishes either manual or automatic settings of the sensors.
 - ▶ Alarm configurations – establishes alarms for CAN speed source timeout, Active trip count, Information mode and Tank content minimum
 - ▶ OEM – The OEM setup menu is password protected and the settings in this menu are directly related to the fitted OEM equipment. Refer to the OEM manual for information regarding OEM settings.

Figure 3-8: Machine



ISOBUS Job Computer: IC18 Sprayer

Filling

Filling establishes the amount of material remaining in the tank and the density of that material.

Different options will be available depending on if a tank sensor is installed and which sprayer mode is active.

NOTE: The size of the tank is established in the OEM menu. This is the number that will repopulate when the FULL TANK KEY  is pressed.

Figure 3-9: Tank filling



Actual content

Actual content displays the current volume of content in the tank. The volume can be manually adjusted.

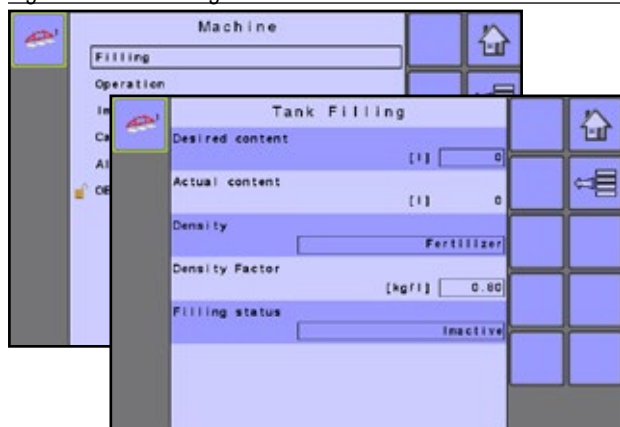
NOTE: When a tank sensor is active, the actual content can not be changed manually.

Density

Density establishes the density of the material being applied. It can be set to either "Fertiliser" or "Water".

NOTE: If "Fertiliser" is selected, a Density Factor option appears.

Density Factor

Density Factor establishes the weight per volume setting based on the type of fertiliser being used. The fertiliser's ability to flow is affected by a number of factors. These factors may vary with each batch and it may change due to weather (humidity, etc.). In order to accommodate for this, the job computer uses a density factor to compensate for the nature of the applied fertiliser.

Full tank

Full tank returns the actual content volume value to the maximum volume of the tank

Full tank - NOT AVAILABLE

The FULL TANK KEY  is not available when a Tank Sensor is activated.

Desired content

Desired content establishes the desired maximum content volume and is only available when Tank sensor or Fill flow sensor is active.

Filling status

Filling status establishes if the tank is actively being filled. It can be set to either "inactive" or "active". Filling status is only available when Tank sensor or Fill flow sensor is active.

Operation

Operation establishes Application rate step, Speed source and Simulated Speed.

Figure 3-10: Operation

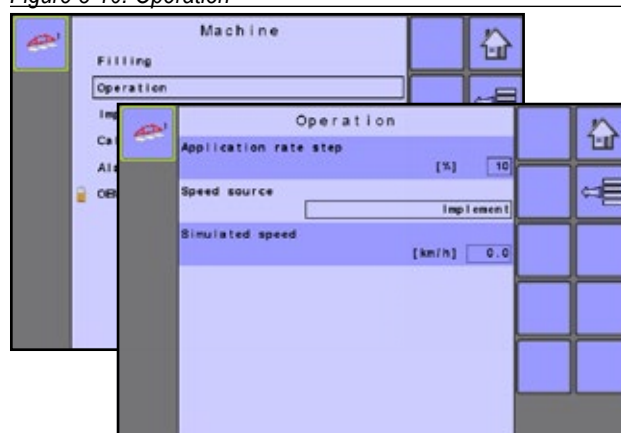

Application rate step

Application rate step is the percent of increase/decrease "boost" of the active application rate at which the product is being applied.

Speed source

Speed source selects whether to base the machine's speed on input from the CAN, an Implement or a Simulated source. Selecting "Implement" will allow for the configuration of impulses per 100 metres. Selecting "Simulated" will allow for simulated speed to be entered using the "Edit value" option. Selecting "CAN" allows for speed being supplied by the ISOBUS CAN (usually from the TECU) to be used.

NOTE: If "Implement" is selected, refer to the Calibrations section for further instructions.

Simulated speed

Simulated speed establishes a speed to be used when using the Simulated speed source.

Implement parameters

Implement parameters establishes the following:

- ▶ Section width – sets the spraying width during application.
- ▶ Nozzle preset setup (Crop Sprayer or Turf Mode) – where up to five (5) sets of nozzle options can be established to set the nozzle type, size, low/high pressure limit, reference flow and reference pressure.
- ▶ Regulation parameters – where adjustments to the valve calibration, nozzle spacing and regulations mode can be established.

Figure 3-11: Implement parameters

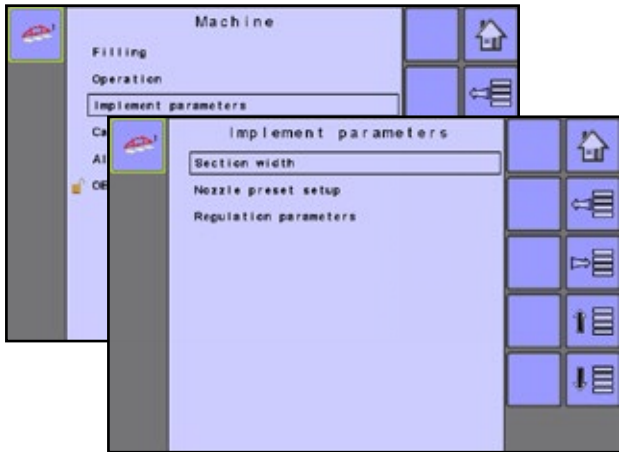

Section width

Section width sets the spraying width during application.

Figure 3-12: Boom section width



Boom section width

Section width establishes the boom section widths for each boom section.

NOTE: The number of boom sections available is set on the Implement parameters screen in the OEM section.

When the section widths are changed, power must be cycled in order to update the task controller.

One-touch equal widths

One-Touch Equal Widths sets all boom section widths to the value set for no.1 Boom Section.

- To set all boom section widths, press the EQUAL SECTION WIDTH KEY .

Nozzle preset setup (Crop Sprayer or Turf Mode)

Nozzle preset setup establishes up to five (5) sets of nozzle options setting the nozzle type, size, low/high pressure limit, reference flow and reference pressure. Available only in Crop Sprayer and Turf Mode.

Figure 3-13: Nozzle preset setup

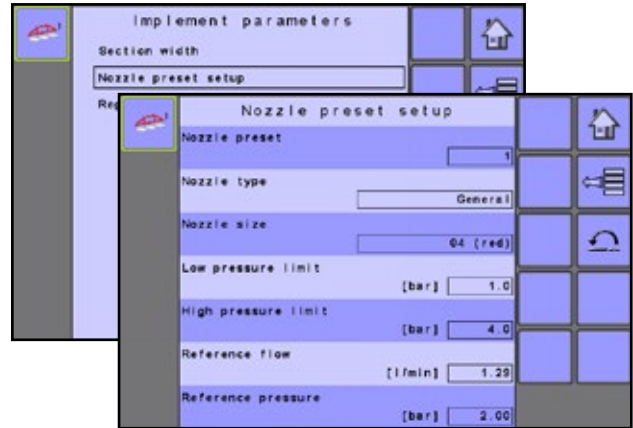

Nozzle preset

Each one of up to five (5) Nozzle presets can be selected to establish different sets of nozzle options.

Nozzle type

Nozzle type sets whether the nozzle's size will be selected from a general section of established nozzles or a optional user nozzle.

Nozzle Size

Nozzle Size sets the nozzle from a list of established sizes (see chart below) or from a optional user nozzle.

Established Nozzle Capacities and Colours			
Size	Colour	Size	Colour
01	Orange	06	Grey
015	Green	08	White
02	Yellow	10	Light Blue
025	Purple	12	Telemagenta
03	Blue	15	Light Green
04	Red	20	Black
05	Brown	30	Beige

NOTE: When "General" nozzle type is selected and a established nozzle size is selected, the Low pressure limit, High pressure limit, Reference flow and Reference pressure fields will be automatically set with the standard settings for the specific nozzle chosen. These setting can be manually adjusted.

Low pressure limit

Low pressure limit establishes the limit for the lowest allowed operating pressure for the selected nozzle type.

High pressure limit

ISOBUS Job Computer: IC18 Sprayer

High pressure limit establishes the limit for the highest allowed operating pressure for the selected nozzle type.

Reference flow

Reference flow establishes the value for the volume applied over a specific time (LPM).

Reference pressure

Reference pressure establishes the pressure value at which the application rate is true (ISO=2 bar).

IMPORTANT! Always refer to the nozzle pressure values recommended by the supplier when setting the nozzle pressure.

Factory settings

Factory settings resets all nozzle settings to the default settings for the selected nozzle size and type.

- To reset the Factory settings, select FACTORY SETTINGS KEY . A confirmation screen will be displayed.

Regulation parameters

Regulation parameters establishes adjustments to the valve calibrations, nozzle spacing and regulations mode.

NOTE: Adjusting the Valve calibration settings involves significant changes and adjustments should therefore be made in small steps.

Figure 3-14: Regulation parameters

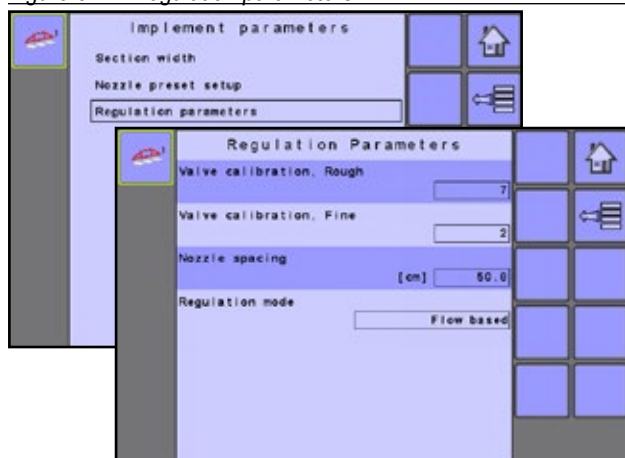

Valve calibration, rough

Rough regulation value calibration allows you to regulate the setting of the regulating valve to accommodate different application needs. Operating conditions may necessitate a higher or lower response setting for the regulating valve. This value adjusts the setting for coarse adjustments in relation to a large percentage outside of the target application rate

- If the system is too slow in finding the correct rate, the values should be increased.
- If the system is too unstable, the values should be decreased.

If your system is plumbed in a bypass mode, the valve setting number of 9 works very well in most applications.

If your system is plumbed in a throttling mode, start with a valve setting number of three (3) and adjust the number according to your application requirements. Low flow situations will require a slower response time. Adjusting agitation volumes to accommodate the

regulating valve to work in a more fully open position allows for a faster response time, with little to no searching.

NOTE: This setting value can be adjusted to optimize system performance. If you notice that the valve seems to “search” for the programmed application rate by cycling the pressure up and down continuously, reduce the number until the “searching” is minimized or eliminated. Conversely, a higher number will increase the valve response time and “speed up” the rate of adjustment.

Valve calibration, fine

Fine regulation value calibration allows you to regulate the setting of the regulating valve to accommodate different application needs. Operating conditions may necessitate a higher or lower response setting for the regulating valve. This digit adjusts the setting for the fine tune adjustment in relation to a small percentage close to the target application rate.

- If the system is too slow in finding the correct rate, the values should be increased.
- If the system is too unstable, the values should be decreased.

If your system is plumbed in a bypass mode, the valve setting number of five (5) works very well in most applications.

If your system is plumbed in a throttling mode, start with a valve setting number of three (3) and adjust the number according to your application requirements. Low flow situations will require a slower response time. Adjusting agitation volumes to accommodate the regulating valve to work in a more fully open position allows for a faster response time, with little to no searching.

NOTE: This setting value can be adjusted to optimize system performance. If you notice that the valve seems to “search” for the programmed application rate by cycling the pressure up and down continuously, reduce the number until the “searching” is minimized or eliminated. Conversely, a higher number will increase the valve response time and “speed up” the rate of adjustment.

Nozzle spacing

Nozzle spacing establishes the distance between the nozzles on the boom.

Regulation mode (Crop Sprayer or Turf Mode)

Regulation mode determines if the rate control is pressure based or flow based. Available only in Crop Sprayer and Turf Mode.

Calibrations

Calibrations establishes either manual or automatic settings of the sensors.

Calibrations Menu Structure Overview:

- ▶ Implement Speed Sensor – establishes wheel pulses over a specified distance
- ▶ Flow Sensor – establishes the pulses per gallon/liter of fluid used when spraying
- ▶ Liquid Pressure Sensor – establish the correct pressure reading
- ▶ Fill Flow Sensor (Crop Sprayer or Turf Mode) – establishes the pulses per gallon/liter of fluid entering the tank while filling
- ▶ Tank Level Sensor (Crop Sprayer or Turf Mode) – establishes tank levels as well as calibrates the tank shape

NOTE: For specific calibration options to appear, a specific sensor needs to be installed. Sensor availability is activated on the Sensor Presence screen in the OEM section.

Figure 3-15: Calibrations

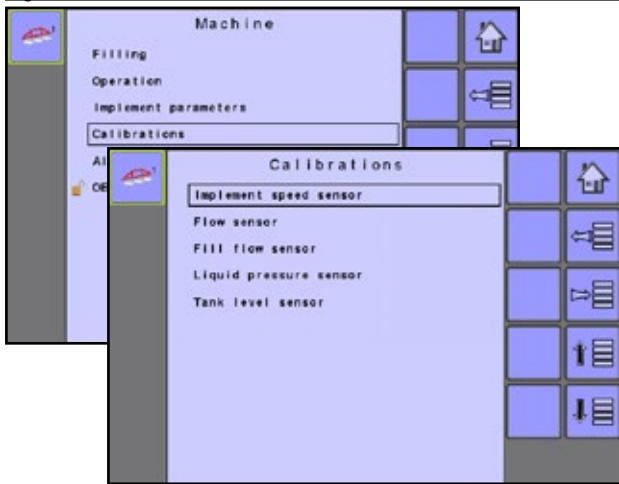

Implement speed sensor

The implement speed sensor establishes the wheel impulses over a specified distance. This value can be established manually or calibrated automatically.

Figure 3-16: Implement Speed Sensor





Manual calibration

Manual calibration establishes the impulses based on a user entered value.

Automatic calibration

Automatic calibration establishes the impulses using the automatic calibration function.

- To calibrate the impulses per distance, select CALIBRATION KEY .
- Follow the series of instructions displayed.
- Select the ACCEPT KEY  to complete the calibration

The counted wheel impulses will be displayed during the automatic calibration.

Flow Sensor

The Flow Sensor establishes the impulses per gallon/litre setting low and high limits. This value can be established manually or calibrated automatically.

Figure 3-17: Flow sensor





Manual calibration

Manual calibration establishes the calibration and limits based on user entered values.

Automatic calibration

If the number of impulses per gallon/litre for the flow metre is not known or to make sure the value is correct, automatic calibration establishes the calibration and limits.

- To calibrate the flow sensor, select CALIBRATION KEY .
- Follow the series of instructions displayed.
- Select the ACCEPT KEY  to complete the calibration

The impulses counted will be displayed during the automatic calibration.

An option to enter a Collected Volume is displayed if there is no calculated volume.

ISOBUS Job Computer: IC18 Sprayer

Liquid pressure sensor

The liquid pressure sensor will show the actual pressure of the liquid at the boom.

Figure 3-18: Liquid pressure sensor

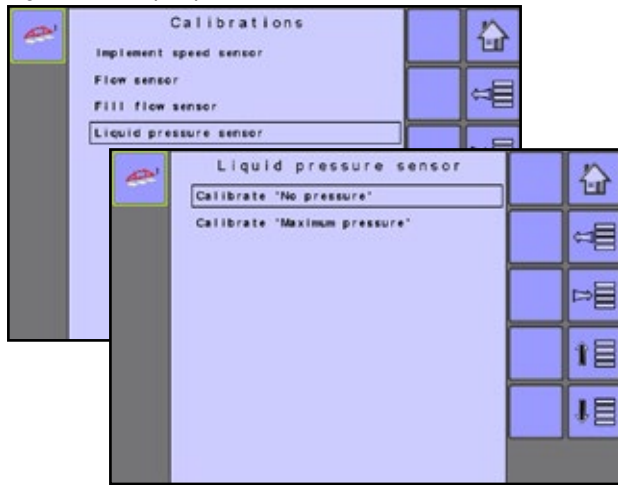

Calibrate each option in the following order:

1 Calibrate “No pressure”

Calibrate “No pressure” establishes the calibration while no pressure is being applied to the liquid pressure sensor.

- To calibrate the liquid pressure sensor with no pressure, select CALIBRATION KEY .

NOTE: Manual calibration is not available.

Figure 3-19: Calibrate “No pressure”



2 Calibrate “Maximum pressure”

Calibrate “Maximum pressure” calculates the maximum pressure level of the attached pressure sensor. This calculation is based on the recommended maximum pressure level and a tested reference pressure level.

Figure 3-20: Calibrate “Maximum pressure”



Maximum liquid pressure

Maximum liquid pressure is determined by the type of pressure sensor used and should be set to the recommendations included with the pressure sensor.

Reference liquid pressure

Reference liquid pressure is the pressure level you will want to reach on the actual pressure sensor when running the calibration process.

Calibration

Calibration is the process to set a point at which the pressure level on the actual pressure sensor and the reference liquid pressure are equal.

- To calibrate the flow sensor, select CALIBRATION KEY .
- Start the application – press the START/STOP KEY .
- Adjust the regulation valve using the REGULATION VALVE OPEN/CLOSE KEYS so that the pressure level on the actual pressure sensor and the reference liquid pressure are equal.
- Select the ACCEPT KEY to complete the calibration

Review the Help screen for more information.

The reference pressure can be changed, but not while in the calibration mode.

Figure 3-21: Liquid pressure sensor calibration



Fill flow sensor (Crop Sprayer or Turf Mode)

The fill flow sensor is used for measuring the volume of water and establishing impulses per gallon/litre going into the sprayer's tank while filling. Available only in Crop Sprayer or Turf Mode.

Figure 3-22: Fill flow sensor





Manual calibration

Manual calibration establishes the calibration based on user entered values.

Automatic calibration

If the number of impulses for the fill flow metre is not known or to make sure the value is correct, automatic calibration establishes the calibration.

- To calibrate the fill flow sensor, select CALIBRATION KEY .
- Follow the series of instructions displayed.
- Select the ACCEPT KEY  to complete the calibration

The impulses counted will be displayed during the automatic calibration.

An option to enter a collected volume is displayed if there is no calculated volume.

Figure 3-23: Fill flow sensor calibration

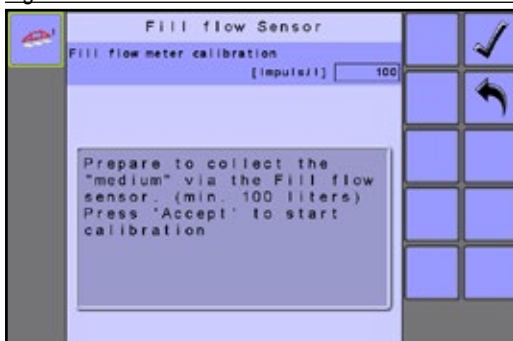

Tank level sensor (Crop Sprayer or Turf Mode)

Tank level sensor establishes the empty, minimum and maximum levels for the tank as well as calibrates the tank shape. Available only in Crop Sprayer or Turf Mode.

Note: Manual calibration is not available for any tank level sensor calibrations.

Figure 3-24: Tank level sensor



Calibrate each option in the following order:

1 Calibrate "Empty"

Calibrate "Empty" establishes the empty tank value.

Figure 3-25: Empty tank

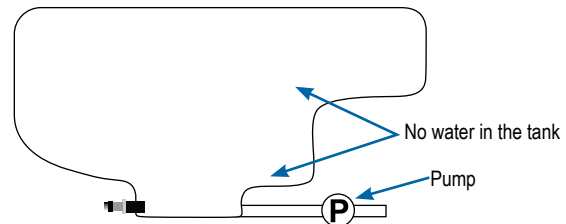

IMPORTANT: The tank should be completely empty.

- To calibrate the Empty tank level, select CALIBRATION KEY .

Figure 3-26: Calibrate "Empty"



ISOBUS Job Computer: IC18 Sprayer

INTRODUCTION

OPERATION

SETUP

TRANSPORT

OEM

APPENDIX

② Calibrate “Minimum level”

Calibrate “Minimum level” establishes the minimum level of water on the tank sensor.

Figure 3-27: Minimum tank level

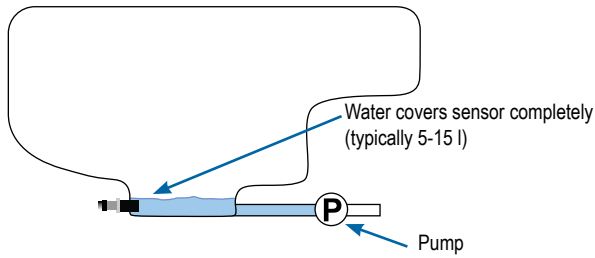

IMPORTANT: Be sure the tank is filled with the contents displayed on the screen. The amount shown is established in Machine-> OEM-> Tank setup-> Minimum content.

- To calibrate the Minimum tank level, select CALIBRATION KEY .

Figure 3-28: Calibrate “Minimum level”



③ Calibrate “Maximum level”

Calibrate “Maximum level” establishes the maximum level of water on the tank sensor.

Figure 3-29: Minimum Tank level

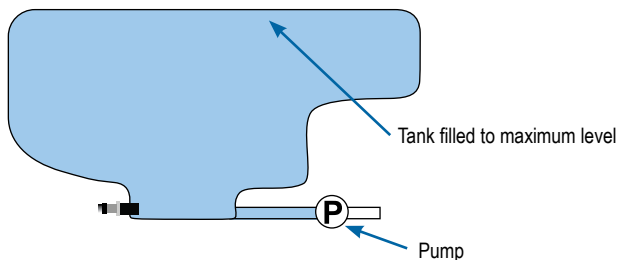

IMPORTANT: Be sure the tank is filled with the contents displayed on the screen. The amount shown is established in Machine-> OEM-> Tank setup-> Maximum content.

- To calibrate the Maximum tank level, select CALIBRATION KEY .

Figure 3-30: Calibrate “Maximum level”



④ Calibrate “Tank shape”

Calibrate “Tank shape” establishes the tank shape.

Figure 3-31: Tank shape calibration

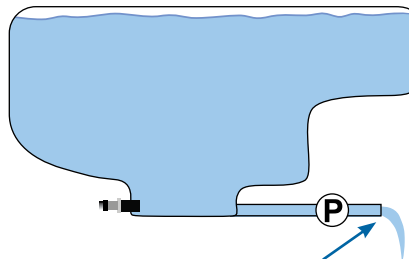

PUMP water at same rate to empty tank in 30-60 minutes



- To begin the Tank shape calibration, select CALIBRATION KEY .
- Follow the series of instructions displayed.
- Select the ACCEPT KEY  to complete the calibration

Figure 3-32: Calibrate “Tank shape”



Alarm configurations

Alarm configurations establishes alarms “on” or “off” as well as sets their trigger level.

Figure 3-33: Alarm configurations

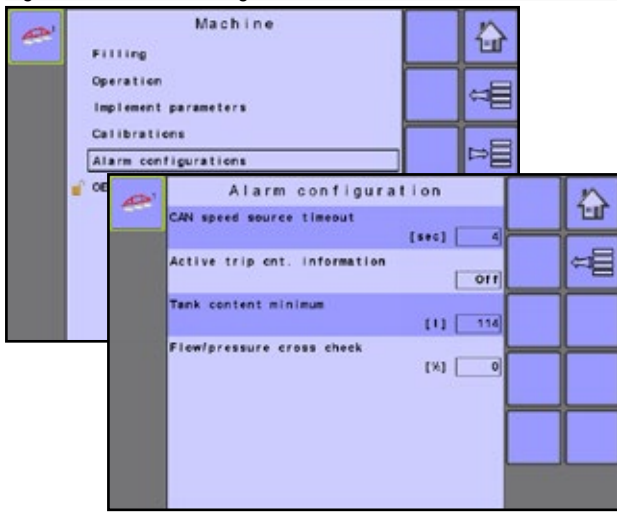

CAN speed source timeout

CAN speed source timeout establishes how long the system can operate after the CAN speed source input is lost before the alarm is triggered.

Active trip count Information

Active trip count Information sets the associated alarm to “on” or “off”. This alarm is only displayed at powered up. It tells the user which trip counter is active.

Tank content minimum

Tank content minimum establishes the minimum volume level at which an alarm will sound. Without a tank sensor, the minimum is determined by calculating the difference between the established actual tank content volume and the calculated applied content volume. With a tank sensor, the minimum is directly related to the sensor reading.

Flow/pressure cross check

Flow/pressure cross check establishes at what percentage the associated alarm will sound. To deactivate this alarm, set the flow/pressure cross check percentage to zero (0).

OEM

The OEM setup menu is password protected and the settings in this menu are directly related to the fitted OEM equipment. Contact the manufacturer or local dealer for service.

NOTE: Some setup options are available or unavailable depending on the OEM settings. See the “Settings menu options table” for more information.

To access the OEM screens:



1. From the Main setup screen , select MACHINE.
2. Select OEM.
3. Select the Access code entry box to the right of the menu option.
4. Use the number pad or slide bar to enter the access code.
5. Select the ACCEPT KEY  to complete the unlock process
6. Select from:
 - ▶ Sensor presence – used to establish sensors for Flow, Liquid pressure, Fill flow and the Tank
 - ▶ Implement parameters – used to establish the Sprayer mode, Number of sections and Circulation
 - ▶ Implement geometry – used to establish the connector type and associated offsets between the vehicle and the implement
 - ▶ Valve setup – used to establish the Regulation valve type, Section valve behaviour and Section valve type
 - ▶ Tank setup – used to establish maximum and minimum tank content, Auto filling mode and Auto filling offset value
 - ▶ Regulation details – used to adjust the control of the regulation valve
 - ▶ Clear total counters – used to delete the Total count system counter for Area, Volume and Time back to the default settings

Figure 3-34: OEM



ISOBUS Job Computer: IC18 Sprayer

USER INTERFACE

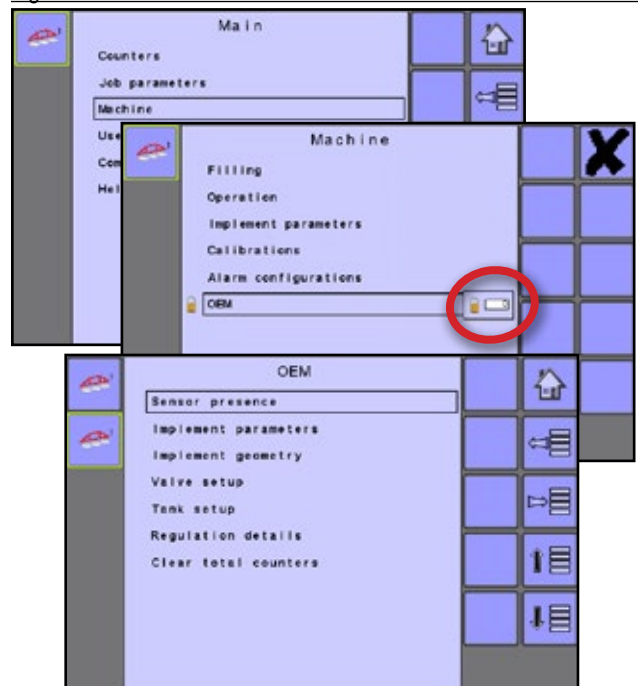
User interface allows the operator to select the system universal terminal (UT), switchbox pairing, BoomPilot ECU pairing and soft key numbering as well as view serial numbers and ECU identification number.

MENU SETUP MODE MENU STRUCTURE

Counters	Job parameters	Machine	User interface	Communication	Help
----------	----------------	---------	-----------------------	---------------	------

1. From the Main setup screen , select USER INTERFACE.

Figure 3-35: User interface

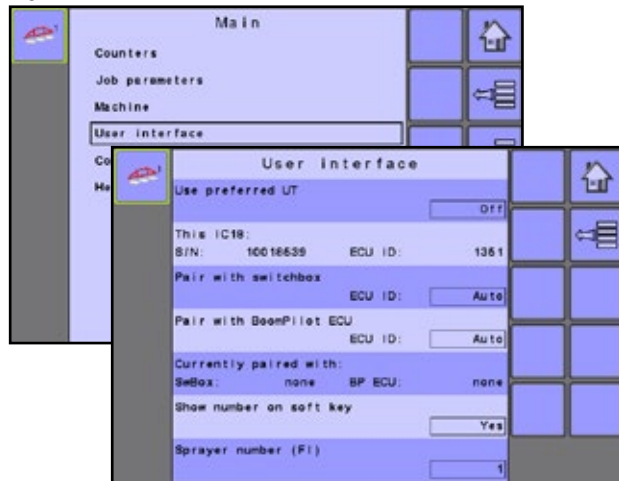

Show number on soft key

Show number on soft key establishes if a user assigned identification number will be visible on the Master screen, Home screen and Operation screen.

NOTE: Typically used only if more than one (1) IC18 ECU is on the CAN BUS. If “Yes” is selected, a Sprayer number (FI) option appears.

Sprayer number (FI)

Sprayer number is the identification number referring specifically to the IC18 ECU referenced under the “This IC18” information row on the User interface screen.

Figure 3-36: Sprayer number

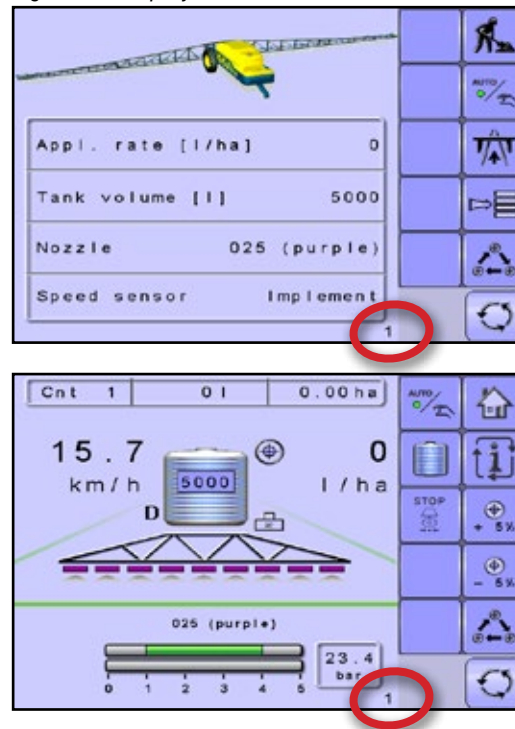

Use preferred UT

Use preferred UT sets the universal terminal preference to either “on” or “off”. If “on” is selected, the preferred UT will be used. If “off” is selected, the system will arbitrarily select which UT to use (if more than one UT is available on the ISOBUS CAN).

NOTE: This should always be set to “off” unless another UT is on the CAN bus.

This IC18

Displays IC18’s serial number and associated ECU identification number.

Pair with switchbox

The pairing of a switchbox can be set to be done automatically, not at all or to a specific switchbox ECU ID number on the CAN network.

Pair with BoomPilot ECU

The pairing of a BoomPilot ECU can be set to be done automatically, not at all or to a specific BoomPilot ECU ID number on the CAN network.

Currently paired with information

Displays the current ECU ID numbers for a paired switchbox or BoomPilot ECU.

- If no switchbox or BoomPilot ECU is on the system, “none” will be shown.
- If a specific switchbox or BoomPilot ECU has been chosen to be paired with and it is not available on the system, “none” will be shown.

COMMUNICATION

Communication establishes the IC18's ability to communicate with an external computer.

MENU SETUP MODE MENU STRUCTURE



1. From the Main setup screen , select COMMUNICATION.

Memory left

Displays the console's memory availability for storage and file transfer.

NOTE: For more information about transferring data from a PC, please contact your local dealer or TeeJet Technologies Customer Service.

Figure 3-37: Communication

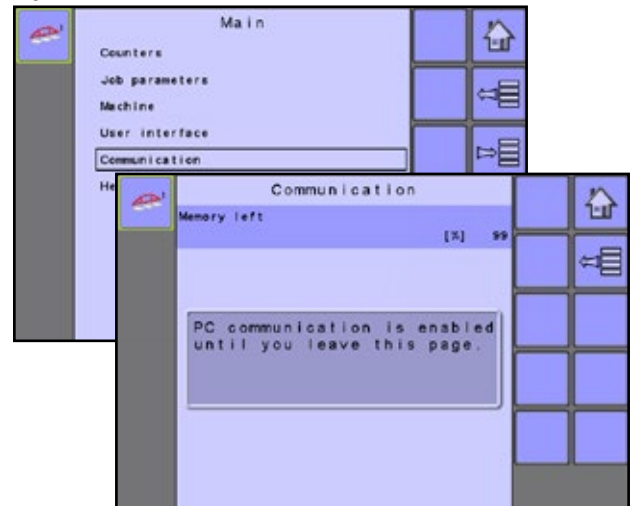

HELP

The Help menu allows the operator to choose between Diagnostics and the display of information about serial number, CAN BUS information, etc. These menus are typically accessed upon Customer Service personnel request only.

MENU SETUP MODE MENU STRUCTURE

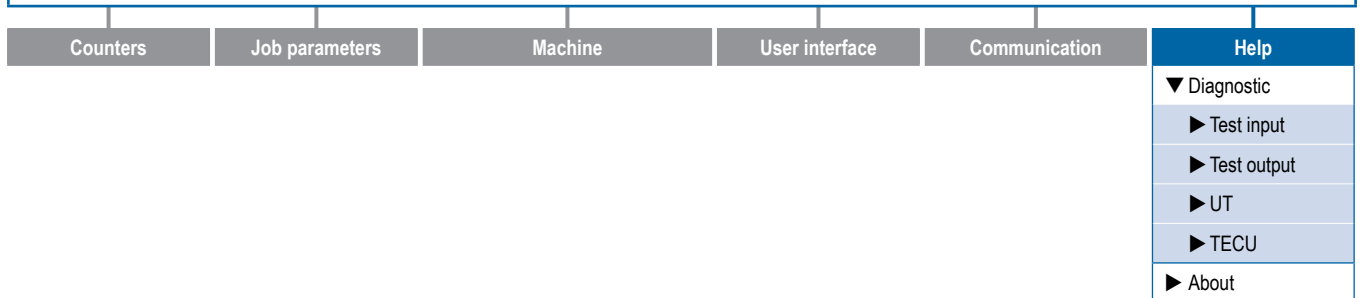

1. From the Main setup screen , select HELP.
2. Select from:
 - ▶ Diagnostic – used to troubleshoot input/output of the controller (sensor or actuator).
 - ▶ About – provides information on the console such as software version, build number, etc.

Figure 3-38: Help



Diagnostic

Diagnostic is used to troubleshoot input/output of the controller (sensor or actuator).

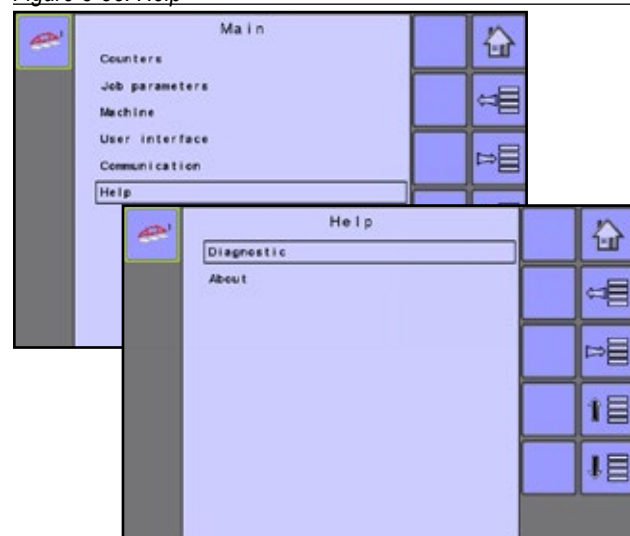
Figure 3-39: Diagnostic



- ▶ Testinput – displays the input high and low values on the installed sensors.
- ▶ Test output – sets the Liquid valve PWM duty cycle percentage as well as if Liquid valve direction, Master valve, Fill valve and Section valves 1-9 are “on” or “off”.
- ▶ UT – provides information regarding the universal terminal controller.
- ▶ TECU – provides information regarding the TECU.

Test input

Test input displays the input high and low values on the installed sensors.

- To reset the sensors to “0”, select RECYCLE BIN KEY .

Figure 3-40: Test Input



Test output

Test output sets the Liquid valve PWM duty cycle percentage as well as if Liquid valve direction, Master valve, Fill valve and Section valves 1 to 9 are “on” or “off”.

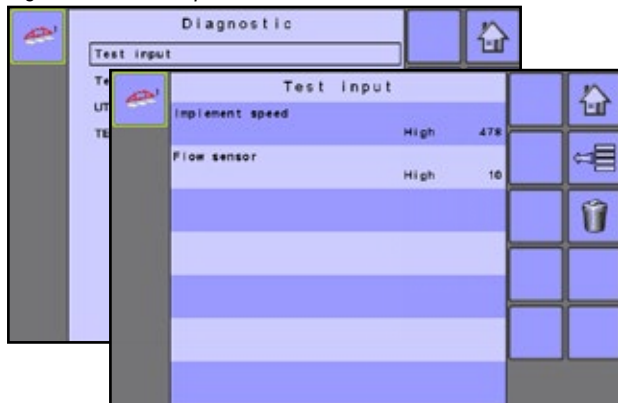
Figure 3-41: Test output



Liquid valve PWM duty cycle

Liquid valve PWM duty cycle is used to test the regulating valve at different percentages of duty cycle.

Liquid valve direction

Liquid valve direction is used to verify if the operation of the Liquid valve direction is correct to a specific duty cycle.

- Set the Liquid valve PWM duty cycle to the percentage to be tested.
- Change the Liquid valve direction to “on” and the liquid valve will open at the specific duty cycle.
- Change it back to “off” and the valve will close.

Master valve

Master valve is used to test if the Master valve is operating correctly. If you change the setting to “on”, the valve will open, change it to “off” and the valve will close.

Section valves

Section valves is used to test if the section Valve is operating correctly. If you change the setting to “on”, the valve will open, change it to “off” and the valve will close.

UT data

The Universal Terminal (UT) menu provides information regarding the virtual terminal controller (i.e., address version, etc.).

- If more terminals/controllers are used, switch between these by pressing the GO TO NEXT UT KEY .
- Press the DELETE OBJECT POOL KEY  to delete saved information on the UT. This forces the UT to upload all information from the IC18 on the next power cycle.

NOTE: Reconnect the IC18 job computer to implement and display changes.

Figure 3-42: UT data

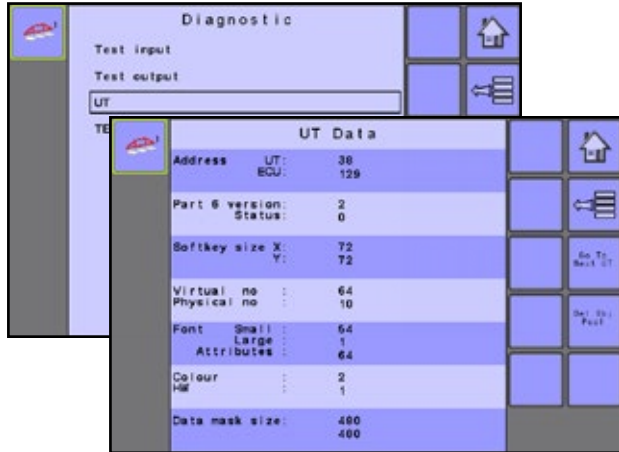

About

The About screen provides information on the IC18 such as software version, build number, etc. This information may become useful in case of technical support.

Figure 3-44: About

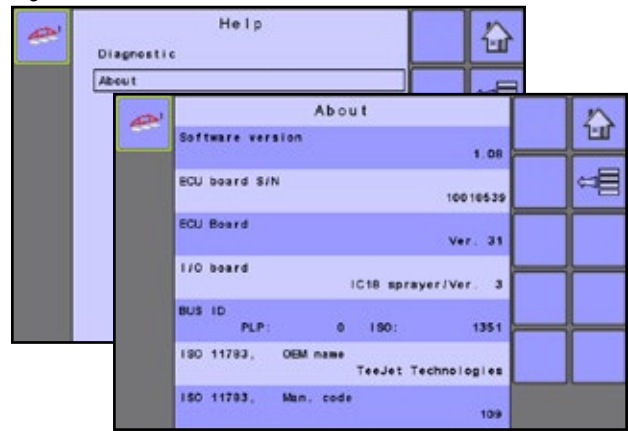

TECU

The TECU is a control unit, residing on the tractor, that performs basic functions such as power handling, speed info, etc. The TECU data are displayed on this page.

Figure 3-43: TECU data

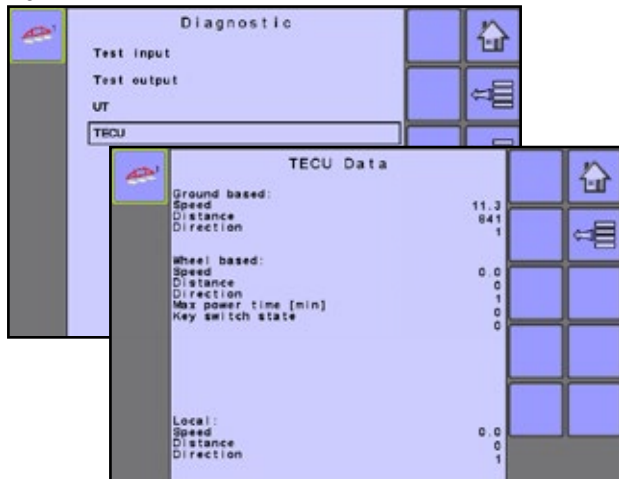

ISOBUS Job Computer: IC18 Sprayer

SETTINGS MENU OPTIONS

The main settings menu contains six (6) options: Counters, Job parameters, Machine, User interface, Communication and Help. Each of these options either directly access settings or additional menus. The table below outlines the additional menus, options available on that menu item and directs you to the setup pages for further information.

* Options may also be set up from Operations screen

✓ Always available

① Available with Flow sensor

② Available with Liquid pressure sensor

③ Available with Fill flow sensor

④ Available with Tank sensor

⑤ Available in Crop Sprayer or Turf Mode

Counters	- Trip	Active trip counter Area Distance Time Volume	✓
	- Campaign	Area Volume Time	✓
	- Total	Area Volume Time	✓
	- Export	.html .cvs	✓
Job parameters	Active trip counter - Preset application rate Nozzle type	✓ ✓ ⑤	
Machine	- *Filling	Desired content Actual content Density type Density factor Filling status	① ② ✓ ⑤ ✓ ③ ④ ⑤
	- Operation	Application rate step Speed source Simulated speed	✓
	- Section width	Boom sections 1 to 5	✓
	- Implement parameters	Nozzle preset Nozzle type Nozzle size - Nozzle preset setup Low pressure limit High pressure limit Reference flow Reference pressure Factory settings	⑤
	- Regulation parameters	Valve calibration, rough Valve calibration, fine Nozzle spacing Regulation mode	✓ ✓ ⑤ ⑤

(Continued on next page)

Machine
(continued)

Machine (continued)	- Implement speed sensor	Calibration number	✓	
		Automatic calibration		
	- Flow sensor	Calibration number		
		Low flow limit	1	
		High flow limit		
	- Calibrations	- Liquid pressure sensor	No pressure	No pressure calibration
			Maximum pressure	Maximum pressure Reference pressure Automatic calibration
		- Fill flow sensor	Calibration number	3
			Automatic calibration	
	- Tank level sensor	Empty tank	Automatic calibration	
		Minimum tank level	Minimum tank level Automatic calibration	
		Maximum tank level	Maximum tank level Automatic calibration	
		Tank shape	Maximum tank level Calibration	
		Import/export settings		
	- Alarms	CAN speed source timeout	✓	
Active trip count information		✓		
Tank content minimum		✓		
Flow/pressure cross check		1 2		
- Sensor presence	Flow sensor	✓		
	Liquid pressure sensor	✓		
	Fill flow sensor	5		
	Tank sensor	5		
- OEM	- Implement parameters	Sprayer mode	✓	
		Number of sections	✓	
		Circulation	5	
- Valve setup	Regulation valve type	✓		
	Section valve behaviour	✓		
	Section valve type	5		
- Tank setup	Maximum contents	✓		
	Minimum contents	✓		
	Automatic filling	5		
	Automatic filling offset	5		

(Continued on next page)

ISOBUS Job Computer: IC18 Sprayer

INTRODUCTION

OPERATION

SETUP

TRANSPORT

OEM

APPENDIX

Machine (continued)	- OEM (continued)	- Regulation details	Minimum regulation pressure	✓
			Maximum regulation pressure	✓
			Regulation valve time	✓
			Minimum regulation voltage	✓
			Regulation deadband	✓
			Regulation backlash	✓
			Regulation start delay	✓
			Anticipation factor	✓
			Default valve position	✓
			Regulation valve capacity	✓
			Regulation start delay	✓
			Minimum speed	✓
			Manual regulation speed	✓
			Restrictor plate flow	5
- Clear total counters	Area			
	Volume	✓		
	Time			
Help	- Diagnostic	Test input		
		Test output		
		Ut	✓	
		TECU		

CHAPTER 4 – TRANSPORT MODE



While in Transport mode, all operation functions are locked “off” and cannot be activated. Transport mode displays the speed in analogue mode.

Figure 4-1: Transport mode from the Home screen

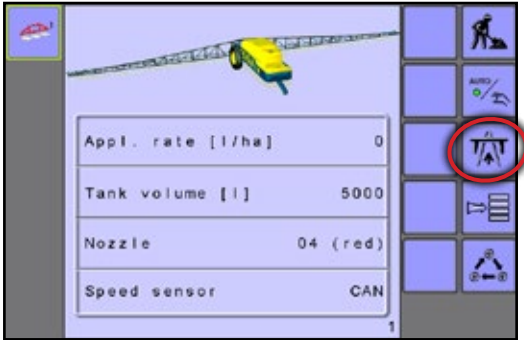
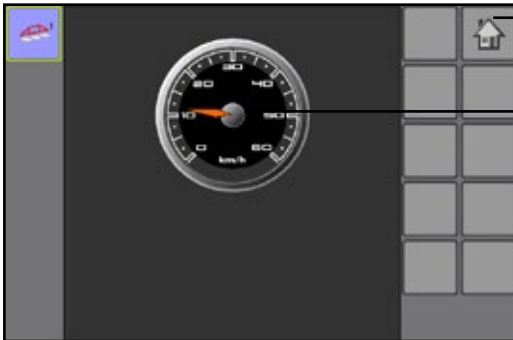

Figure 4-2: Transport mode



Home key - Gives access to the IC18's available functions:
Operation mode, Transport mode and Main setup

Speedometer

CHAPTER 5 – OEM OPTIONS

The OEM setup menu is password protected and the settings in the menu are directly related to the fitted OEM equipment. Contact the manufacturer or local dealer for service.

NOTE: Setup options may vary depending on the OEM settings. See the “Settings Menu Options Table” for more information.

MENU SETUP MODE MENU STRUCTURE

Counters	Job Parameters	Machine	User Interface	Communication	Help
		▶ *Filling			
		▶ Operation			
		▶ Implement parameters			
		▶ Calibrations			
		▶ Alarm configurations			
		▼ OEM			
		▶ Sensor presence			
		▶ Implement parameters			
		▶ Implement geometry			
		▶ Valve setup			
		▶ Tank setup			
		▶ Regulation details			
		▶ Clear total counters			

The OEM setup menu is password protected and the settings in this menu are directly related to the fitted OEM equipment.

**Menu settings directly related to OEM equipment.*



- From the Main Setup Screen , select MACHINE.
- Select OEM.
- Select the Access Code Entry Box to the right of the menu option.
- Use the number pad or slide bar to enter the access code.
- Select the ACCEPT KEY  to complete the unlock process
- Select from:
 - ▶ Sensor Presence – used to establish sensors for Flow, Liquid Pressure, Fill Flow and the Tank
 - ▶ Implement Parameters – used to establish the Sprayer Mode, Number of Sections and Circulation
 - ▶ Implement Geometry – used to establish the connector type and associated offsets between the vehicle and the implement
 - ▶ Valve Setup – used to establish the Regulation Valve Type, Section Valve Behavior and Section Valve Type
 - ▶ Tank Setup – used to establish maximum and minimum tank content, Auto Filling mode and Auto Filling Offset value
 - ▶ Regulation Details – used to adjust the control of the regulation valve
 - ▶ Clear Total Counters – used to delete the Total Count system counter for Area, Volume and Time back to the default settings

Figure 5-1: OEM



Sensor Presence

Sensor Presence establishes sensors for Flow, Liquid Pressure, Fill Flow and the Tank. If the fitted sensors are not registered here, the sensor options will not be available in the calibration menus.

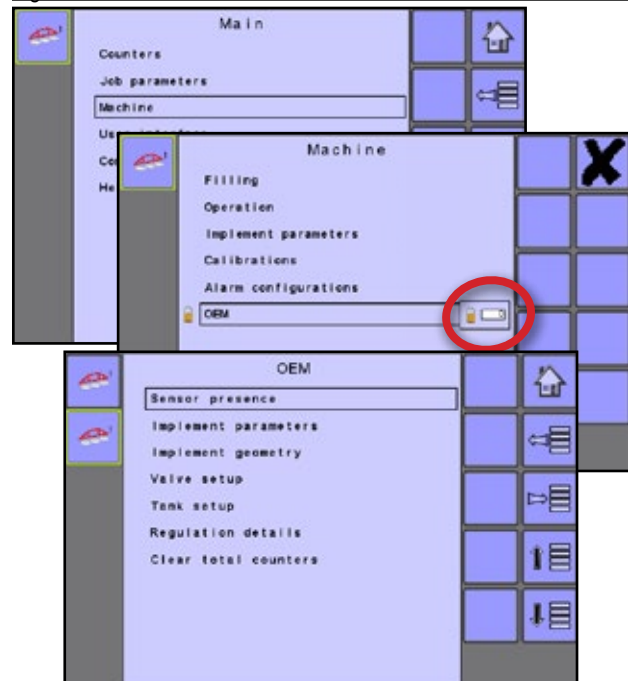
Figure 5-2: Sensor Presence

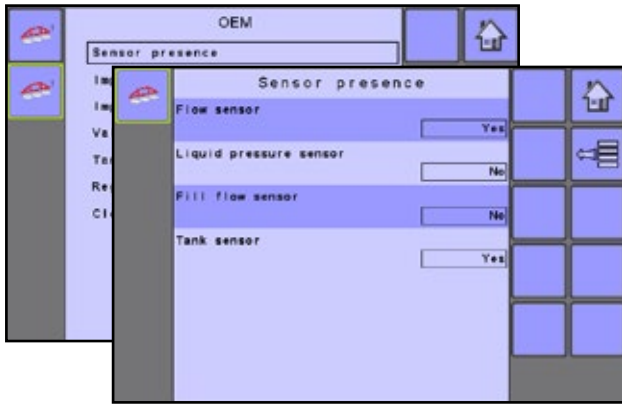

Flow Sensor

Flow Sensor sets the associated sensor availability to "Yes" or "No".

Liquid Pressure Sensor

Liquid Pressure Sensor sets the associated sensor availability to "Yes" or "No".

Fill Flow Sensor (Crop Sprayer or Turf Mode)

Fill Flow Sensor sets the associated sensor availability to "Yes" or "No". Available only in Crop Sprayer or Turf Mode.

Tank Sensor (Crop Sprayer or Turf Mode)

Tank Sensor sets the associated sensor availability to "Yes" or "No". Available only in Crop Sprayer or Turf Mode.

Implement Parameters

Implement Parameters establishes the Sprayer Mode, Number of Sections and if there is tank circulation.

Figure 5-3: Implement Parameters

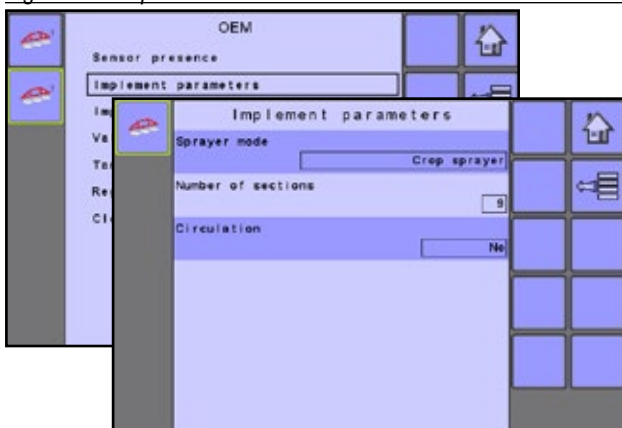

Sprayer Mode

Sprayer Mode sets the implement parameter to either Crop Sprayer, Turf or NH3.

NOTE: When sprayer mode is changed, power must be cycled before all settings will be displayed correctly.

Number of Sections

Number of Sections establishes how many sections are on the boom.

NOTE: The number established here affects options under Main -> Implement Parameters -> Section Width -> Boom Section Width and on the Operations Screen.

Circulation (Crop Sprayer or Turf Mode)

Circulation sets if there is No, Semi or Full tank circulation. Available only in Crop Sprayer Mode.

Implement Geometry

Implement Geometry establishes the connector type and associated offsets between the vehicle and the implement.

Figure 5-4: Implement Geometry

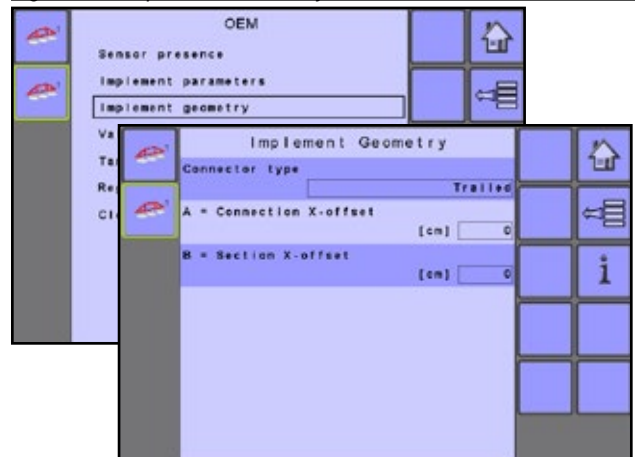

Connection Type

Connection Type establishes the type of connection between the vehicle and the implement.

Different machines have different options. The following machines are detailed in this manual. Contact your TeeJet dealer for information on your specific setup or if there are any questions.

- Three point hitch – rear mount
- Trailed – always rear mount

Review the Help Screen  for more information about each connection type.

A = Connection X-offset

Measured in parallel to the centerline of the machine, defines the distance from the connection point to the center of the front axle of trailed implement.

B = Section X-offset

Measured in parallel to the centerline of the machine, defines the distance from the center of the rear axle to the implement.

ISOBUS Job Computer: IC18 Sprayer

Three point hitch – rear mount

- Ⓐ – Center of the GNSS antenna
- Ⓑ – Connection Point
- ① – Connection Point In-line Offset Direction/Distance
- ② – Connection Point Lateral Offset Direction/Distance
- ④ – B=Section X-offset distance
- ⑤ – Implement In-line Offset Direction/Distance

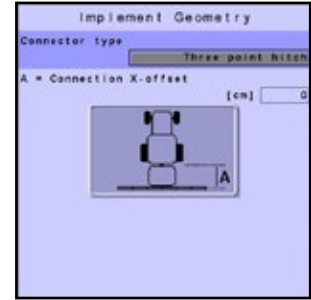
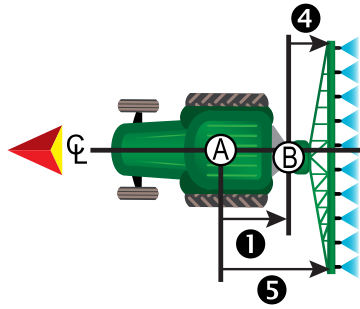

Trailed – always rear mount

- Ⓐ – Center of the GNSS antenna
- Ⓑ – Connection Point
- Ⓒ – Center of the front axle of the trailed implement
- ① – Connection Point In-line Offset Direction/Distance
- ② – Connection Point Lateral Offset Direction/Distance
- ③ – A=Connection X-offset distance
- ④ – B=Section X-offset distance
- ⑤ – Implement In-line Offset Direction/Distance

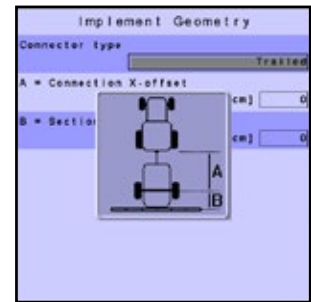
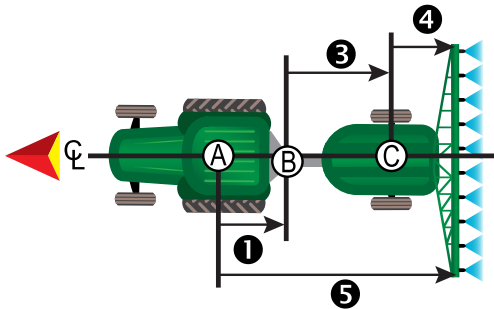

Valve Setup

Valve Setup establishes the Regulation Valve Type, Section Valve Type and Section Valve Behavior.

Figure 5-5: Valve Setup

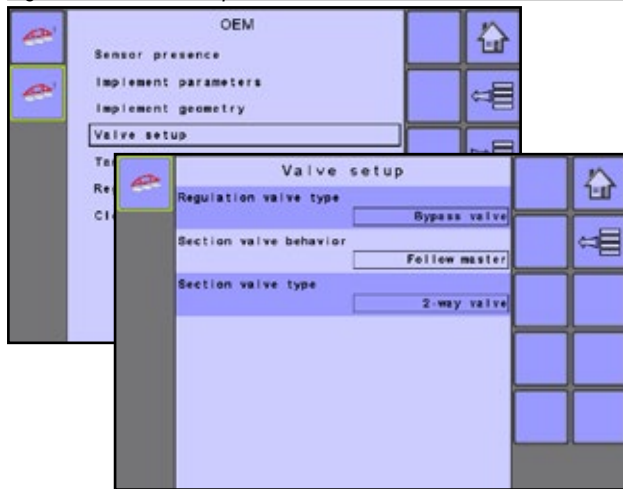

Tank Setup

Tank Setup establishes maximum and minimum tank content, Auto Filling mode and Auto Filling Offset value.

Figure 5-6: Tank Setup

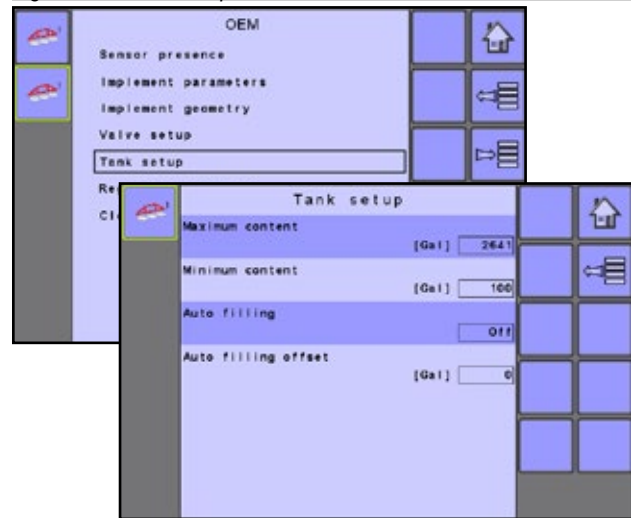

Regulation Valve Type

Regulation Valve Type sets the valve type to either Throttle or Bypass.

Section Valve Behavior

Section Valve Behavior sets the valve to either Independent or Follow Master.

Section Valve Type (Crop Sprayer or Turf Mode)

Section Valve Type sets the valve type to either 2-way or 3-way. Available only in Crop Sprayer and Turf Mode.

Maximum Content

Maximum Content establishes the maximum tank volume.

Minimum Content

Minimum Content establishes the minimum tank volume at which the tank agitation should automatically be shut off.

Auto Filling (Crop Sprayer Mode)

Auto Filling sets the automatic filling mode to either on or off. Available only in Crop Sprayer Mode.

Auto Filling Offset (Crop Sprayer Mode)

Auto Filling Offset establishes the volume that will still run into the tank after the fill valve has started shutting. Available only in Crop Sprayer and Turf Mode.

Regulation Details

Regulation Details adjust the control of the regulation valve.

Figure 5-7: Regulation Details

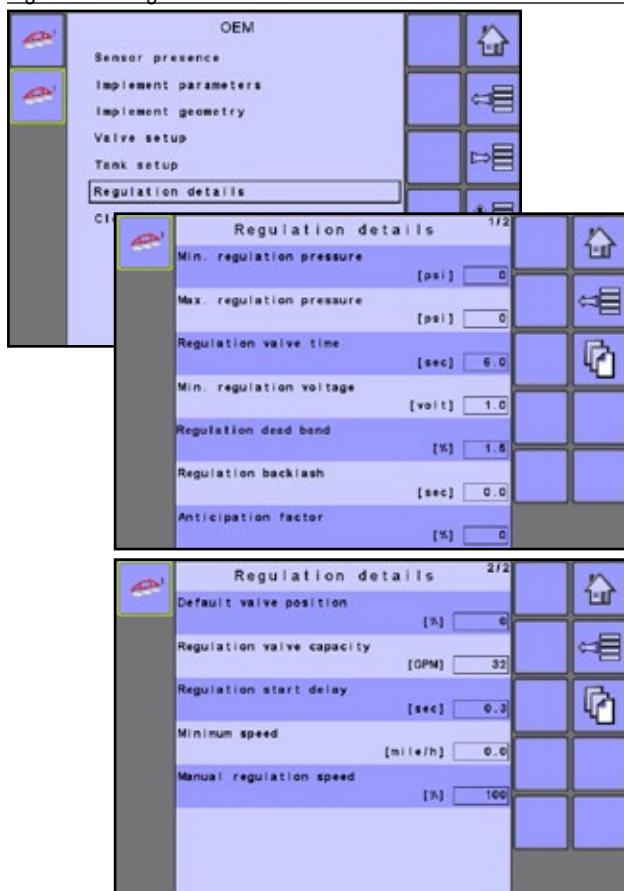

Minimum Regulation Pressure (Crop Sprayer or Turf Mode)

Minimum Regulation Pressure establishes the minimum pressure. The working pressure will not drop lower than this level, even if a lower pressure is required by the regulation system (the controller). If the actual pressure on the sprayer becomes lower than this value, the regulating system will continue to increase the pressure until the minimum pressure level has been reached. Available only in Crop Sprayer and Turf Mode.

Maximum Regulation Pressure (Crop Sprayer or Turf Mode)

Maximum Regulation Pressure establishes the maximum pressure. The working pressure will not rise higher than this level, even if a higher pressure can be obtained by the regulation system (the controller). If the actual pressure on the sprayer becomes higher than this value, the regulating system will continue to decrease the pressure until the maximum pressure level has been reached. Available only in Crop Sprayer and Turf Mode.

Regulation Valve Time

Regulation Valve Time establishes the time, in seconds, for the regulation valve to go from fully closed to fully open (or vice versa).

NOTE: The time is determined by the type of regulation valve used and should be set to the recommendations included with the regulation valve.

Minimum Regulation Voltage

Minimum Regulation Voltage establishes the lowest voltage at which the regulation valve will start to move. The controller uses variable voltage to control the valve; the closer the actual rate is to the target rate, the lower the voltage sent to the valve is. The minimum voltage must therefore be found when the valve is under pressure, as this affects the force required to move the valve.

Regulation Dead Band

Regulation Dead Band establishes an acceptable regulation dead band in percent. Regulation will stop when the difference between the target rate and the actual rate is lower than the entered dead band (percent of the target rate). This is to prevent the valve from oscillating when the actual rate is near the target rate.

Regulation Backlash

Regulation Backlash establishes the time in seconds it takes before the valve starts moving after a direction change.

Anticipation Factor

Anticipation Factor establishes the anticipation factor to ensure that the regulation valve is in a suitable position when switching the master valve on (when turning at headland).

- ▶ 0 = Off. The regulation valve remains stationary at the position when the main valve is switched off.
- ▶ 100 = Full. The regulation valve will move completely to the calculated position.

The number of boom sections open, the target rate, the average forward speed, the regulation valve time and the maximum reg. valve capacity are used to calculate a theoretical position of the regulation valve when the master valve is off (when turning at headland).

Default Valve Position

Default Valve Position establishes the percentage value for the valve position.

Regulation Valve Capacity

Regulation Valve Capacity establishes the capacity of the regulation valve in volume per minute.

Regulation Start Delay

Regulation Start Delay establishes the delay in seconds from when the main valve is switched on until regulation starts.

Minimum Speed

Minimum Speed establishes the forward speed at which the system should automatically switch the master valve off.

Manual Regulation Speed

Manual Regulation Speed establishes the percentage of the regulation valve controlling the speed at which the regulation valve should move in manual operation mode.

Restrictor Plate Flow (Crop Sprayer or Turf Mode)

Restrictor Plate Flow establishes the capacity of the restrictor plate in volume per minute and is to be used when working with return flow (circulation). Available only in Crop Sprayer or Turf Mode.

ISOBUS Job Computer: IC18 Sprayer

Clear Total Counters

Clear Total Counters deletes the Total Count system counter for Area, Volume and Time back to the default settings of "0".

- To clear the total counters, select TRASH CAN KEY . A confirmation screen will be displayed.

Figure 5-8: Clear Total Counters



Area

Displays total applied area for all trips.

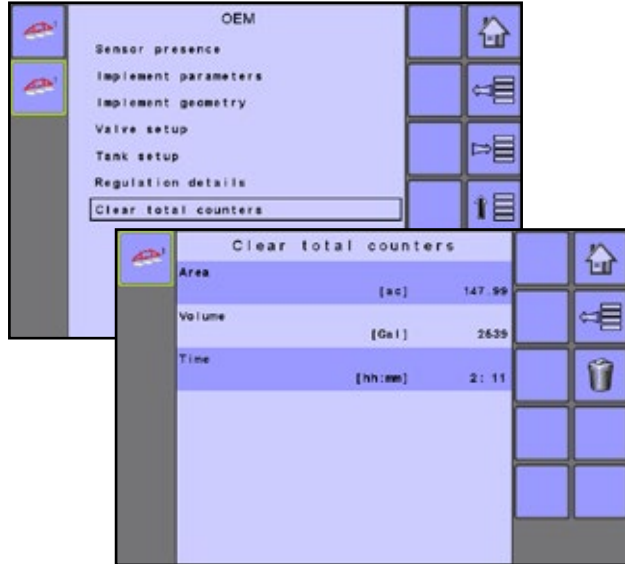
Volume

Displays total volume of material applied during all trips.

Time

Displays total time traveled for all trips.

APPENDIX A - FACTORY SETTINGS & RANGES

JOB PARAMETRES

Description	Factory setting	Range	User setting
Active trip counter	1	1 - 10	1
			2
			3
			4
			5
			6
			7
			8
			9
			10
Preset Application Rate no.1	0.0 GPA (US)	0.0 - 700.6 (US)	no.1
Preset Application Rate no.2	0.0 l/ha	0.0 - 6553	no.2
Preset Application Rate no.3	0.0 GPA (UK)	0.0 - 583.4 (UK)	no.3
Preset Application Rate no.4			no.4
Preset Application Rate no.5			no.5
Nozzle	Established under Machine--> Implement parameters--> Nozzle preset setup		

MACHINE

Tank filling

Description	Factory setting	Range/options	User setting
Actual Content	0 lbN (US)	0 - 12000	
	0 kgN	0 - 5443	
	0 lbN (UK)	0 - 12000	
Density	Water	Water Fertiliser	
Density Factor	6.68 Lb/Gal (US)	6.68 - 16.69 (US)	
	0.80 kg/l	0.80 - 2.00	
	8.02 Lb/Gal (UK)	8.02 - 20.04 (UK)	

Operation

Description	Factory setting	Range/options	User setting
Application rate step	5%	1 - 20	
Speed source	CAN	CAN Implement Simulated	
Simulated Speed	0.0 mile/h / km/h	0.0 - 99.9	

(continued on next page)

ISOBUS Job Computer: IC18 Sprayer

Implement parameters

Regulation parameters

Description	Factory setting	Range	User setting
Valve calibration, rough	19	1 - 19	
Valve calibration, fine	9	1 - 9	
Nozzle spacing	19.7 in 50 cm	1.0 - 787.4 1.0 - 1999.9	
Regulation mode	Flow based	Pressure based Flow based	

Section width

Description	Factory setting	Range	User setting
Section width	118 in. / 300 cm	1 - 9999	

Nozzle preset setup

Description	Factory setting	Range/options	User setting
Nozzle preset	1	1 - 5	1
			2
			3
			4
			5
Nozzle type	General	General User Nozzle	
Nozzle size	025 (purple)	01 Orange 015 Green 02 Yellow 025 Purple 03 Blue 04 Red 05 Brown 06 Grey 08 White 10 Light Blue 12 Telemagenta 15 Light Green 20 Black	
Low pressure limit	14 psi 1.0 bar	0 - 369 0.0 - 25.5	
High pressure limit	58 psi 4.0 bar	0 - 369 0.0 - 25.5	
Reference flow	0.25 GPM (US) 0.81 l/min 0.18 GPM (UK)	0.00 - 26.42 (US) 0.00 - 999.99 0.00 - 22.00 (UK)	
Reference pressure	40 psi (US) 2.00 bar 29 psi (UK)	1 - 1450 (US) 0.10 - 99.99 1 - 1450 (UK)	

(continued on next page)

Calibrations

Implement speed sensor

Description	Factory setting	Range/options	User setting
Impulses per distance	0	0 - 33445	

Alarm configurations

Description	Factory setting	Range/options	User setting
CAN speed source timeout	4 sec	0 - 999	
Active trip count Imformtaion	Off	Off On	
Tank content minimum	0 GAL (US) 0 litres 0 GAL (UK)	0 - 2641 (US) 0 - 9999 0 - 2199 (UK)	

USER INTERFACE

Description	Factory setting	Range/options	User setting
Use preferred UT	Off	Off On	
Pair with switchbox	Auto	Auto None <<specific ID no.>>	
Pair with BoomPilot ECU	Auto	Auto None <<specific ID no.>>	
Show number on soft key	No	No Yes	
Sprayer number (FI)	1	1 - 9	

APPENDIX B - UNIT SPECIFICATIONS

Dimensions	7.5 x 7.25 x 2.375 in / 19.05 x 18.42 x 6.03 cm
Weight	1.42 lbs / 0.644kg
Connector	30 position Cinch pins. A1-K3 30 position Cinch pins. L1-Y3
Environmental	Operating Humidity
	-40 to +85°C 90% non-condensing
Input/output	ISO 11783 (ISOBUS)
Power requirement	<9 watts @12 VDC

IC18 SPRAYER JOB COMPUTER USER MANUAL

Software Version 1.09



TeeJet Technologies

www.teejet.com

A Subsidiary of  **Spraying Systems Co.**

98-05204-EN-A4 R4 English-International
© TeeJet Technologies 2017