

IC18 SPRAYER JOB COMPUTER

U S E R M A N U A L

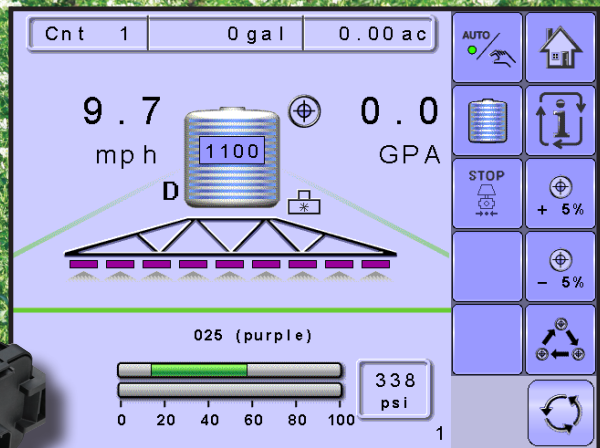

Software version 1.06



TeeJet[®]
TECHNOLOGIES

A Subsidiary of  Spraying Systems Co.[®]

COPYRIGHTS

© 2012 TeeJet Technologies. All rights reserved. No part of this document or the computer programs described in it may be reproduced, copied, photocopied, translated, or reduced in any form or by any means, electronic or machine readable, recording or otherwise, without prior written consent from TeeJet Technologies.

TRADEMARKS

Unless otherwise noted, all other brand or product names are trademarks or registered trademarks of their respective companies or organizations.

LIMITATION OF LIABILITY

TEEJET TECHNOLOGIES PROVIDES THIS MATERIAL "AS IS" WITHOUT WARRANTY OF ANY KIND, EITHER EXPRESSED OR IMPLIED. NO COPYRIGHT LIABILITY OR PATENT IS ASSUMED. IN NO EVENT SHALL TEEJET TECHNOLOGIES BE LIABLE FOR ANY LOSS OF BUSINESS, LOSS OF PROFIT, LOSS OF USE OR DATA, INTERRUPTION OF BUSINESS, OR FOR INDIRECT, SPECIAL, INCIDENTAL, OR CONSEQUENTIAL DAMAGES OF ANY KIND, EVEN IF TEEJET TECHNOLOGIES HAS BEEN ADVISED OF SUCH DAMAGES ARISING FROM TEEJET TECHNOLOGIES SOFTWARE.

To ensure optimal use of the equipment, please read this manual thoroughly. Please contact TeeJet Technologies Customer Support or an authorized TeeJet Technologies dealer if additional support is required.

RESPONSIBILITY FOR USE OF THIS PRODUCT

Regarding responsibility for use of this product, we refer to our sales and delivery terms which states:

Product Usage

Any use of the product is at the sole risk of the buyer. The buyer is therefore not entitled to any form for compensation caused by, for example, any of the following:

- ▶ Disturbance to/from any electronic services or products that do not conform to the standards for CE marketing;
 - ▶ Missing or poor signal coverage or a succession hereof from external transmitters/receivers used by the buyer;
- Functional faults which apply to or from a PC-program or PC equipment not delivered by the seller;
- ▶ Faults that may arise from the buyers' negligence to react to warnings and fault messages from the product or that can be traced to negligence and/or absent constant control of the work carried out in comparison to the planned job.

When implementing any new equipment the buyer must take great care and pay attention. Any doubts as to the correct operation/use should result in contacting the seller's service department.

Table of Contents

CHAPTER 1 – PRODUCT OVERVIEW	1
OPTIONAL SYSTEM COMPONENTS	2
CONFIGURATIONS	4
CHAPTER 2 – GETTING STARTED	7
START UP	7
APPLICATION MODE	8
PAGE LAYOUT AND NAVIGATION	9
Home Screen	9
Transport Mode	9
Operation Mode	10
Main Setup Mode	11
<i>Main Setup Menu Icons and Section Overviews</i>	12
CHAPTER 3 – MAIN SETUP IN SPRAYER MODE	15
Main Setup Screen	16
Master Screen	17
Home Screen	17
COUNTERS	18
Trip Counters	19
<i>Active Trip Counter</i>	19
<i>Area Counter</i>	19
<i>Distance Counter</i>	19
<i>Time Counter</i>	19
<i>Volume Counter</i>	19
Campaign Counters	20
<i>Area Counter</i>	20
<i>Volume Counter</i>	20
<i>Time Counter</i>	20
Total Counters	20
<i>Area Counter</i>	20
<i>Volume Counter</i>	20

OVERVIEW
GETTING STARTED
SETUP
OPERATION
APPENDIX

ISOBUS Job Computer : IC18 Sprayer

Time Counter	20
Export Counters	21

JOB PARAMETERS 22

Active Trip Counter	22
Preset Application Rates	22
Nozzle	22

MACHINE 23

Filling	24
Actual Content	24
Density	24
Density Factor	24
Full Tank	24
Operation	25
Application Rate Step	25
Speed Source	25
Simulated Speed	25
Implement Parameters	26
Section Width	26
Boom Section Width	26
One-Touch Equal Widths	26
Nozzle Preset Setup	27
Nozzle Preset	27
Nozzle Type	27
Nozzle Size	27
Low Pressure Limit	28
High Pressure Limit	28
Reference Flow	28
Reference Pressure	28
Factory Settings	28
Regulation Parameters	29
Valve Calibration, Rough	29
Valve Calibration, Fine	29
Nozzle Spacing	30
Regulation Mode	30
Calibrations	31
Implement Speed Sensor	31
Manual Calibration	31
Automatic Calibration	31
Flow Sensor	32

OVERVIEW

GETTING STARTED

SETUP

OPERATION

APPENDIX

ISOBUS Job Computer : IC18 Sprayer

Manual Calibration	32
Automatic Calibration	32
Alarm Configurations	33
CAN Speed Source Timeout	33
Active Trip Count Information	33
Tank Content Minimum	33
OEM	34

USER INTERFACE 35

Use Preferred VT	35
This IC18	35
Pair with Switchbox	35
Pair with BoomPilot ECU	35
Currently Paired With Information	36
Show Number on Soft Key	36
Sprayer Number (FI)	36

COMMUNICATION 37

HELP 38

Diagnostic	39
Test Input	39
Test Output	40
Liquid Valve PWM Dutycycle	40
Liquid Valve Direction	40
Master Valve	40
Section Valves	40
VT Data	41
TECU	41
About	41

CHAPTER 4 – OPERATION MODE 43

AUTOMATIC OR MANUAL REGULATION MODE 43

OPERATION MODE OVERVIEW 44

Keys Descriptions	45
Section and Icon Descriptions	46
Master Screen	48
Home Screen	48

APPLICATION RATE OPTIONS 49

OVERVIEW
GETTING STARTED
SETUP
OPERATION
APPENDIX

ISOBUS Job Computer : IC18 Sprayer

Target Rate Percentage Increase/Decrease.....	49
Regulation Valve Manual Open/Close.....	49
Target Rate	50
With Switchbox	50
Without Switchbox	50

BOOM SECTIONS 51

On/Off Sections from the Left or Right.....	52
Without Switchbox	52
With Switchbox	52
Start/Stop Application	53
Without Switchbox	53
With Switchbox	53
Master Stop Key	54
With Switchbox	54

INFORMATION KEY 55

TRANSPORT MODE 56

APPENDIX A - FACTORY SETTINGS & RANGES 57

APPENDIX B - UNIT SPECIFICATIONS 61

OVERVIEW

GETTING STARTED

SETUP

OPERATION

APPENDIX

CHAPTER 1– PRODUCT OVERVIEW

Congratulations on the purchase of your new IC18 ECU built on the ISOBUS architecture. This IC18 unit has the capability of either sprayer or NH3 control when integrated into the implement of either capability. When used within the guidelines of this manual, the IC18 controller will be a reliable application tool.

This manual covers the Sprayer functions of the IC18 ECU. For NH3 functions, see manual number 98-05230.

Use with your existing VT or Matrix® 570VT

- Works seamlessly and displays on any ISOBUS VT
- Easy navigation menu and data rich display
- IC18 Sprayer ECU suitable for use with NH3 and liquid fertilizer
- Automatic boom section control upgrade option
- Variable rate control available providing your VT has GPS and task control capability
- Easy navigation menu and data rich display
- Add additional ISOBUS ECUs as your needs change
- Provides basic rate control
- Standardized plugs, cables and software simplify installation and connectivity and result in true “plug and play” technology. IC18 ECU resides on the implement, reducing hardware in the cab

Figure 1-1: IC18 Job Computer



ISOBUS Job Computer : IC18 Sprayer

OPTIONAL SYSTEM COMPONENTS

Matrix 570VT

The Matrix 570VT is a simple to operate, ISOBUS-certified 5.7" (14.5 cm) color touch screen display suitable for bright daylight and nighttime operation

Figure 1-2: Matrix 570VT



IC18 Spreader Electronic Control Unit

Use with your existing VT or the Matrix 570VT for dry product application

- Works seamlessly and displays on any ISOBUS VT
- Easy navigation menu and data rich display
- Add additional ISOBUS ECUs as your needs change
- Provides basic rate control or variable rate if the connecting VT has variable rate task control capabilities
- Standardized plugs, cables and software simplify installation and connectivity and result in true “plug and play” technology. IC18 ECU resides on the implement, reducing hardware in the cab

Figure 1-4: IC18 Spreader Electronic Control Unit



Switchbox

Manual section control with remote master capability. The switchboxes are available in two configurations.

- ▶ 9 sections output or 8 sections and a master output
- ▶ 6 sections output or 5 sections and a master output

Figure 1-3: Switchboxes

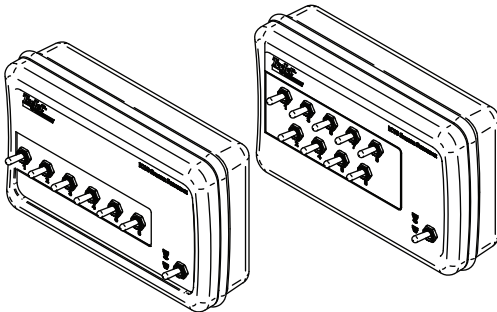

BoomPilot Electronic Control Unit for IC18

BoomPilot (automatic boom section control) is possible in combination with software built into the IC18 Sprayer/NH3 Electronic Control Unit (ECU). The ECU should be combined with the appropriate cable to interface with your BoomPilot system, spray controller and/or spraying machine for quick and easy installation. Electronic Control Units and their related cables are designed to control as many boom sections as the spray controller to which they are connect, up to a maximum of 9 boom sections.

Figure 1-5: BoomPilot Electronic Control Unit



ISOBUS Job Computer : IC18 Sprayer

CONFIGURATIONS

The following diagrams are reflective of typical IC18 Job Computer configurations. Due to the variety of possible configurations, these should be used for reference purposes only.

Figure 1-6: IC18 Sprayer Retro Kit to Matrix 570VT Harnessing with BoomPilot ECU and Optional Switchboxes

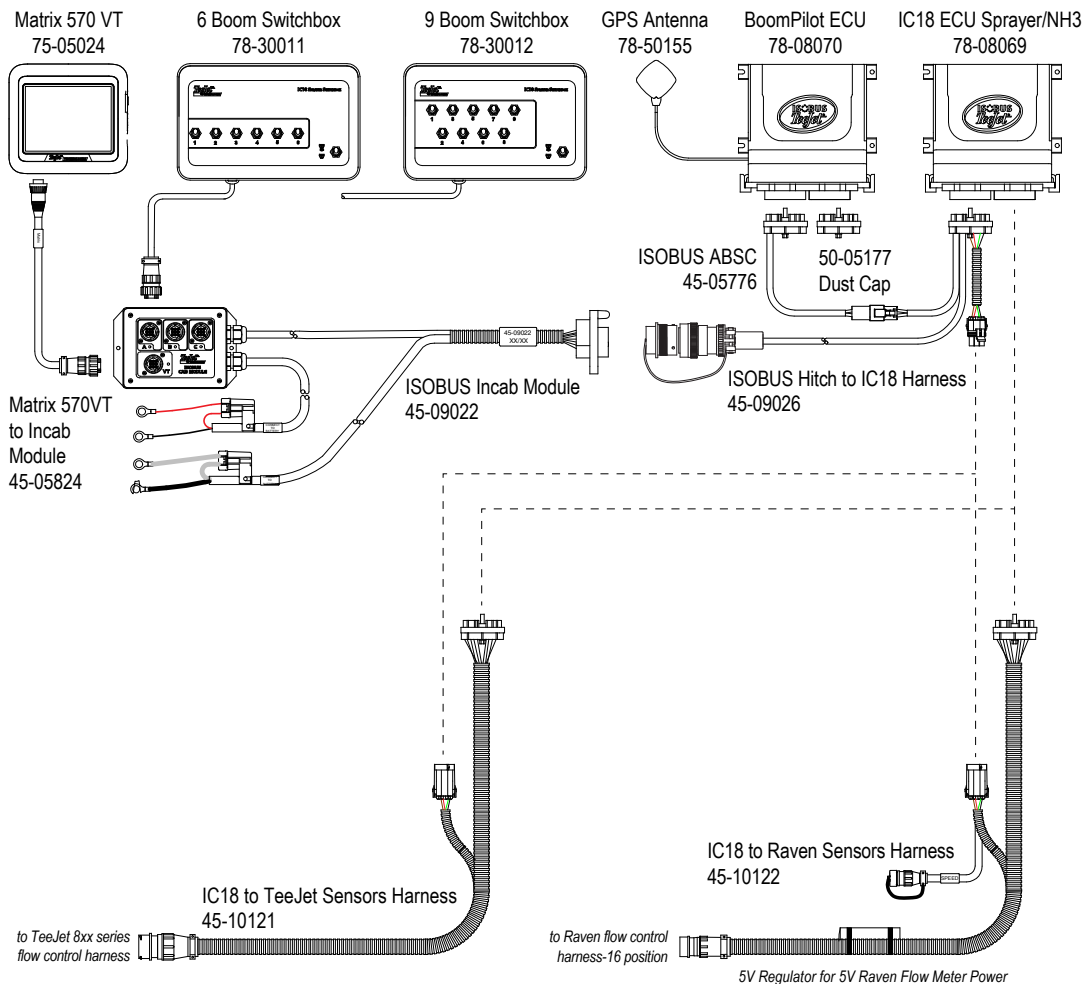

Included in TeeJet Retro Kit

Included in Raven 440-460 Retro Kit

ISOBUS Job Computer : IC18 Sprayer

Figure 1-7: IC18 Sprayer TeeJet Retro Kit to Matrix 570 VT Harnessing. With optional Rate Controller and Matrix 570G for section control and Mapping capabilities

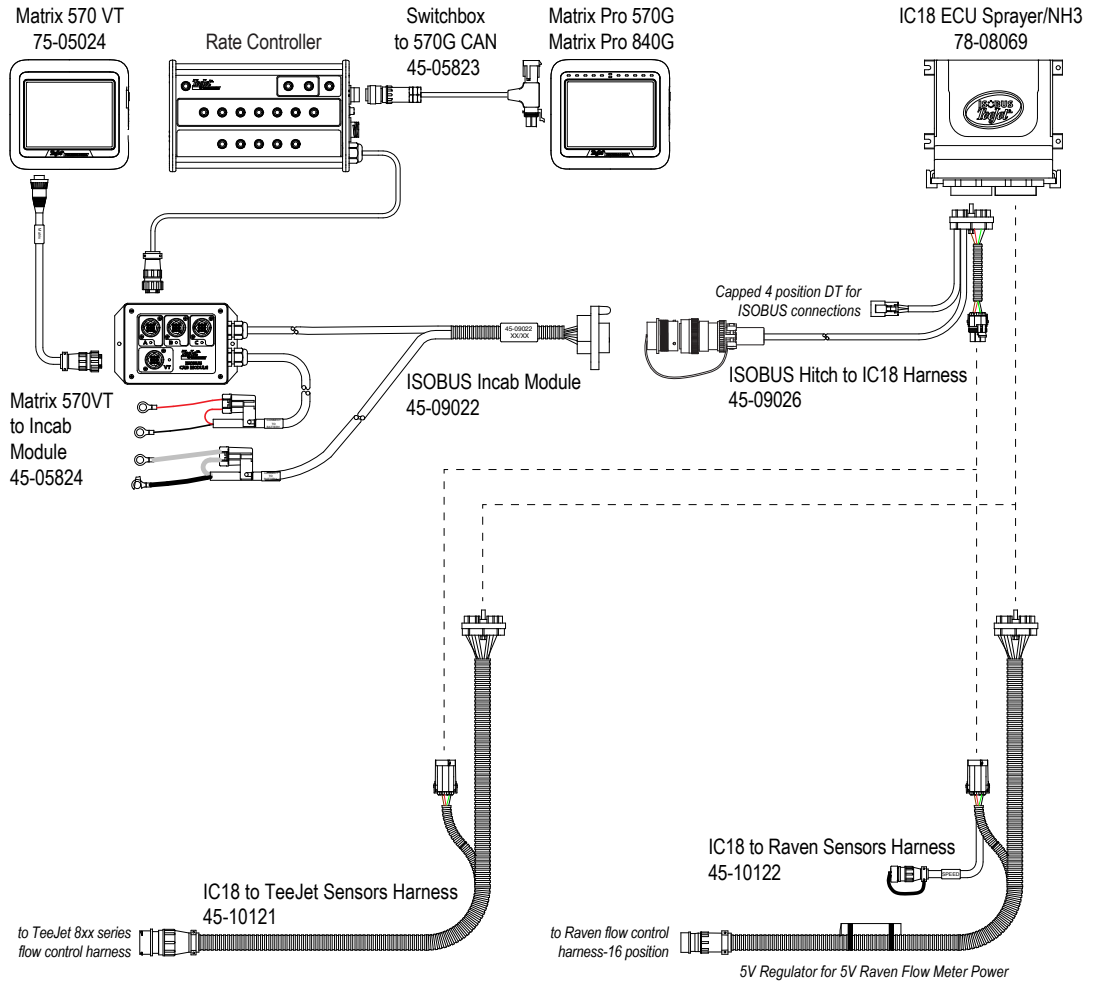

Included in TeeJet Retro Kit

Included in Raven 440-460 Retro Kit

ISOBUS Job Computer : IC18 Sprayer

OVERVIEW



GETTING STARTED

SETUP

OPERATION

APPENDIX

CHAPTER 2 – GETTING STARTED

- A firm touch is required when selecting a screen icon.
- Settings are NOT automatically saved when selected. The ACCEPT KEY  must be selected to save the setting. Select the ESCAPE KEY  to escape without saving settings and return to the previous menu.
- The console needs to be cycled off and back on when changing or attaching equipment to the system.
- The menu structure on your display might vary from the one displayed in this User Manual depending on the virtual terminal being used.

START UP

Power is continuously supplied to the job computer. The virtual terminal will give access to the job computer options and operation.

Figure 2-1: Master Screen - Crop Sprayer Mode

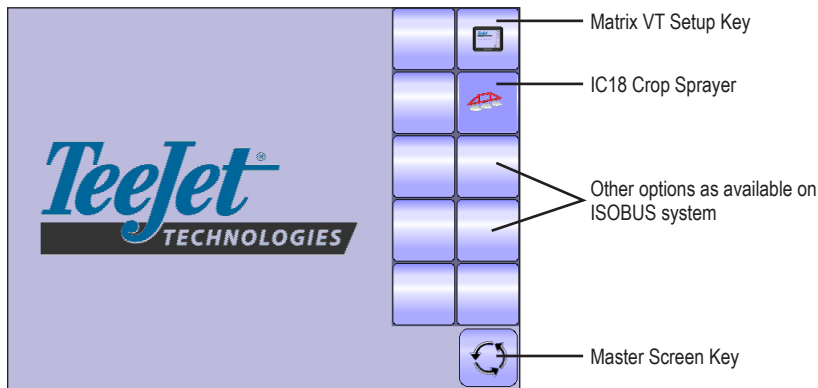

ISOBUS Job Computer : IC18 Sprayer

APPLICATION MODE

The IC18 job computer is programmed to be either a sprayer or NH3 applicator. This setting has been established before leaving the factory, but it can be changed after purchase with assistance from TeeJet Technologies Customer Service or your local dealer through the OEM setup menu options.

Figure 2-2: Crop Sprayer

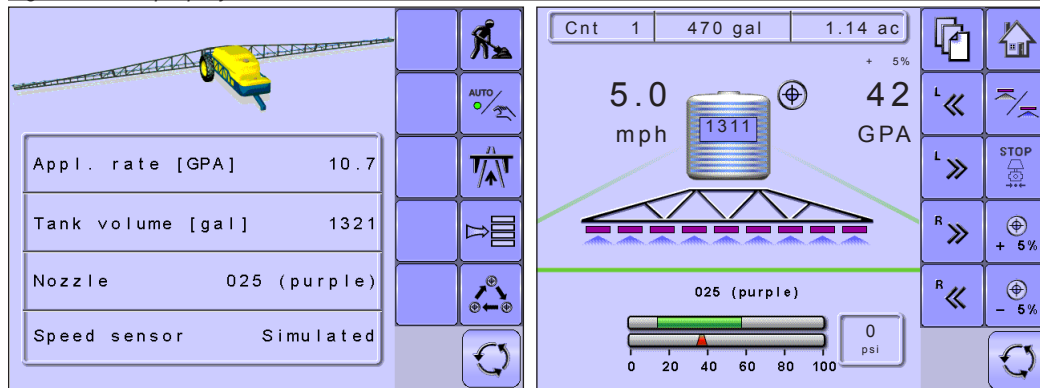
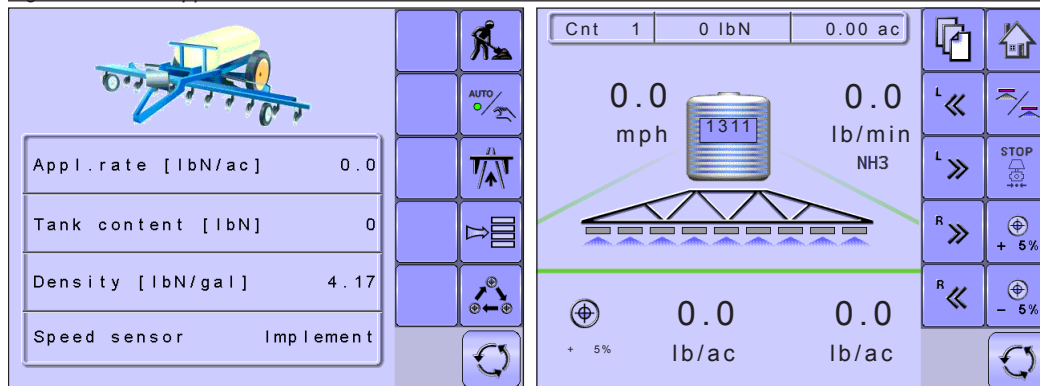

Figure 2-3: NH3 Applicator



This manual discusses specifically the functions and options in Crop Sprayer Mode. See the specific IC18 NH3 User Manual for functions and options in NH3 Mode.

PAGE LAYOUT AND NAVIGATION

The Master Screen gives access to the systems currently available on your VT. From the Master Screen, the Home Screen gives access to the IC18's available functions.

Home Screen



The Home Screen gives access to the IC18's available functions: Operation Mode, Transport Mode and Main Setup.

Figure 2-4: Home Screen - Crop Sprayer Mode

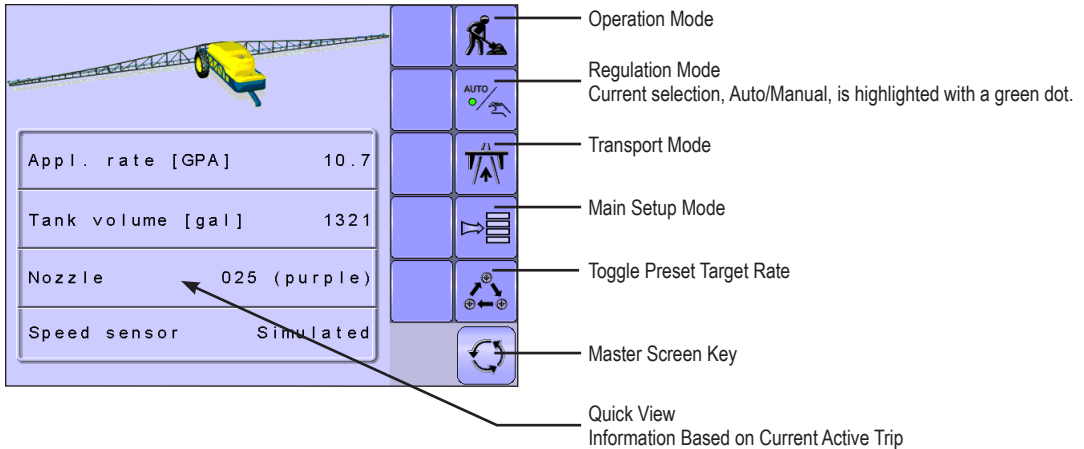

Transport Mode



While in Transport Mode, all operation functions are locked off and cannot be activated.

Figure 2-5: Transport Mode

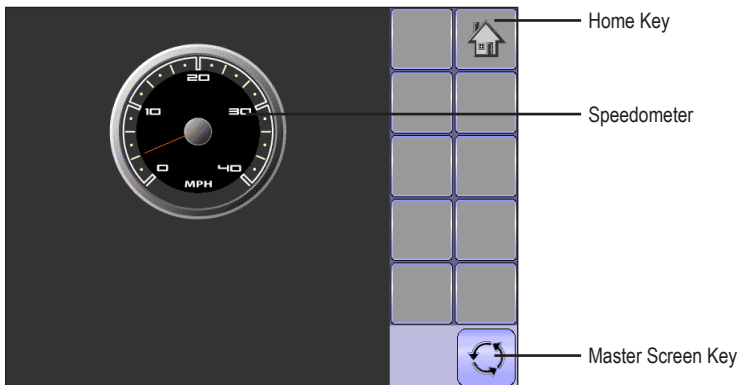

ISOBUS Job Computer : IC18 Sprayer

Operation Mode



Information on the Operation screen will vary depending on the parameters set by the user and the OEM.

Figure 2-6: Operation Mode Screen Overview

OVERVIEW

GETTING STARTED

SETUP

OPERATION

APPENDIX

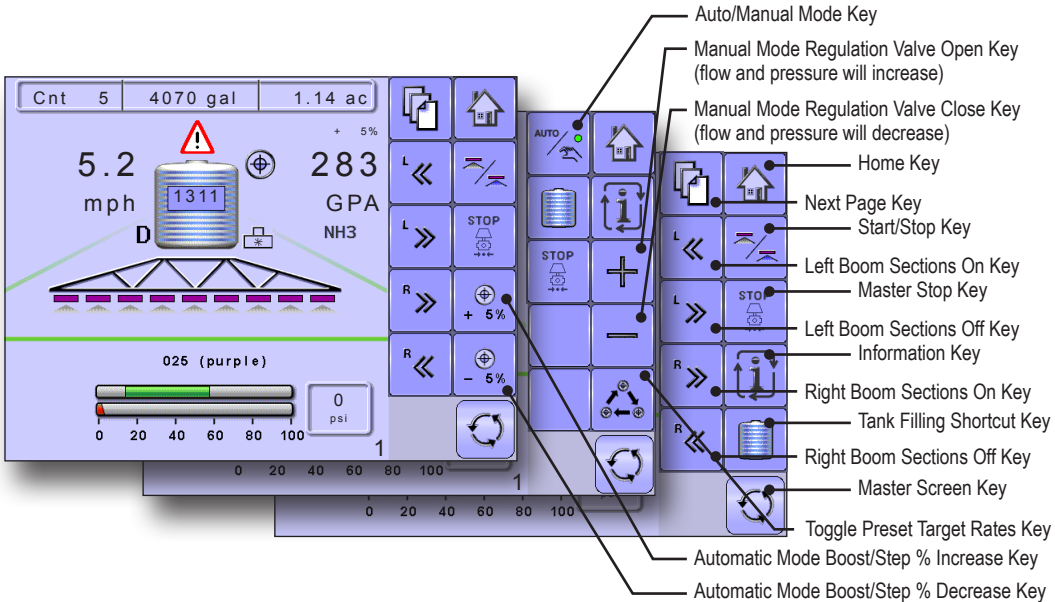
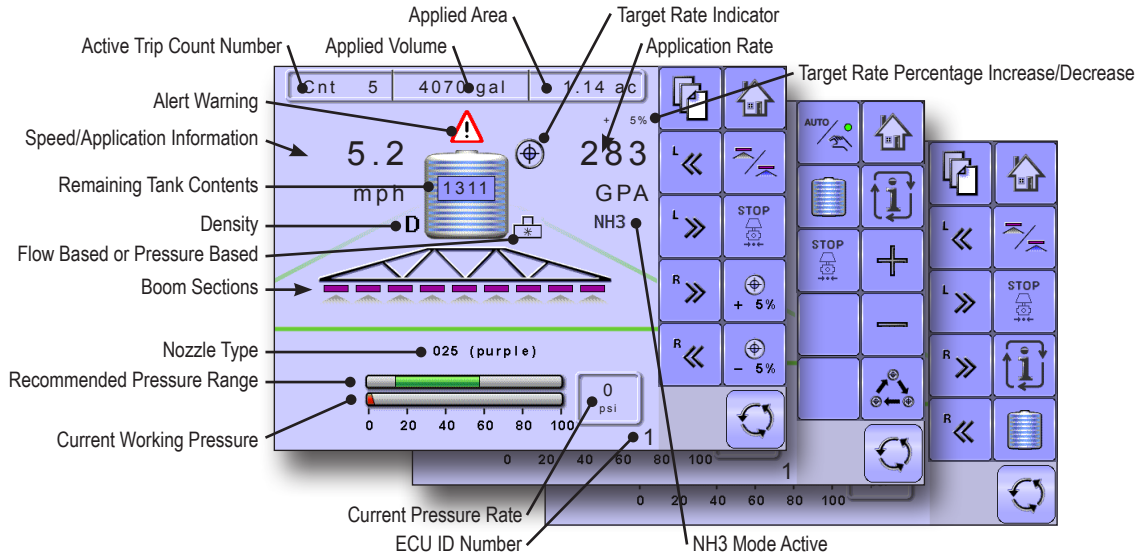

Main Setup Mode



The main setup menu contains six options. Each of these options either directly access settings or additional menus.

Figure 2-7: Main Setup Screen

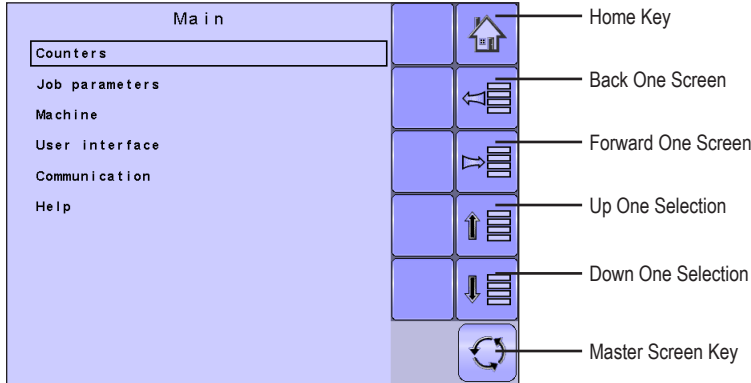

The table below outlines the additional menus and directs you to the setup pages for further information.

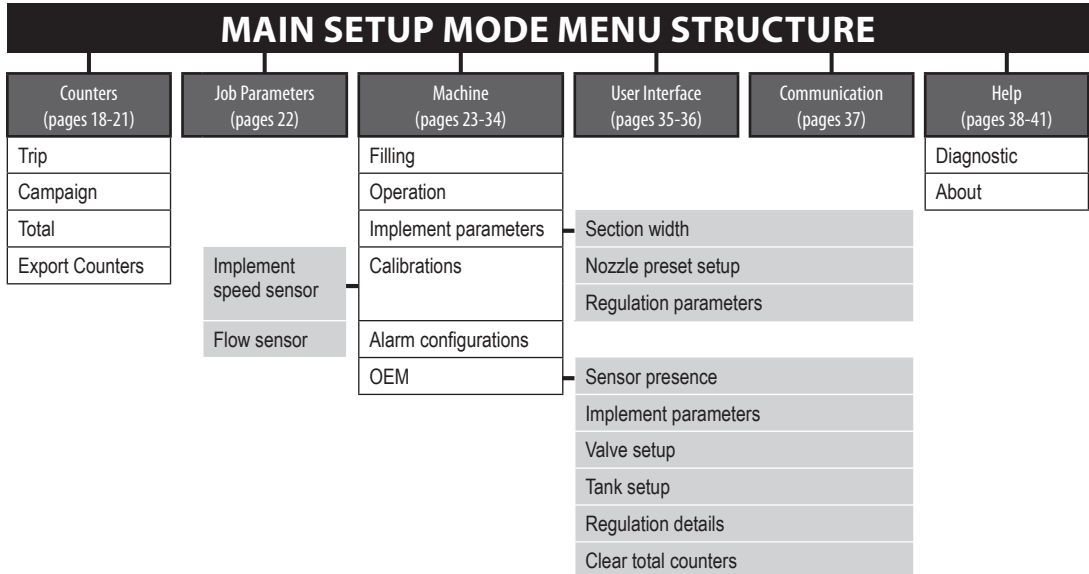

NOTE: Select functions may not be visible due to OEM settings, available equipment or sensors.

The OEM setup menu is password protected and the settings in this menu are directly related to the fitted OEM equipment. Refer to the IC18 Sprayer/NH3 OEM Setup Manual for information regarding OEM settings.







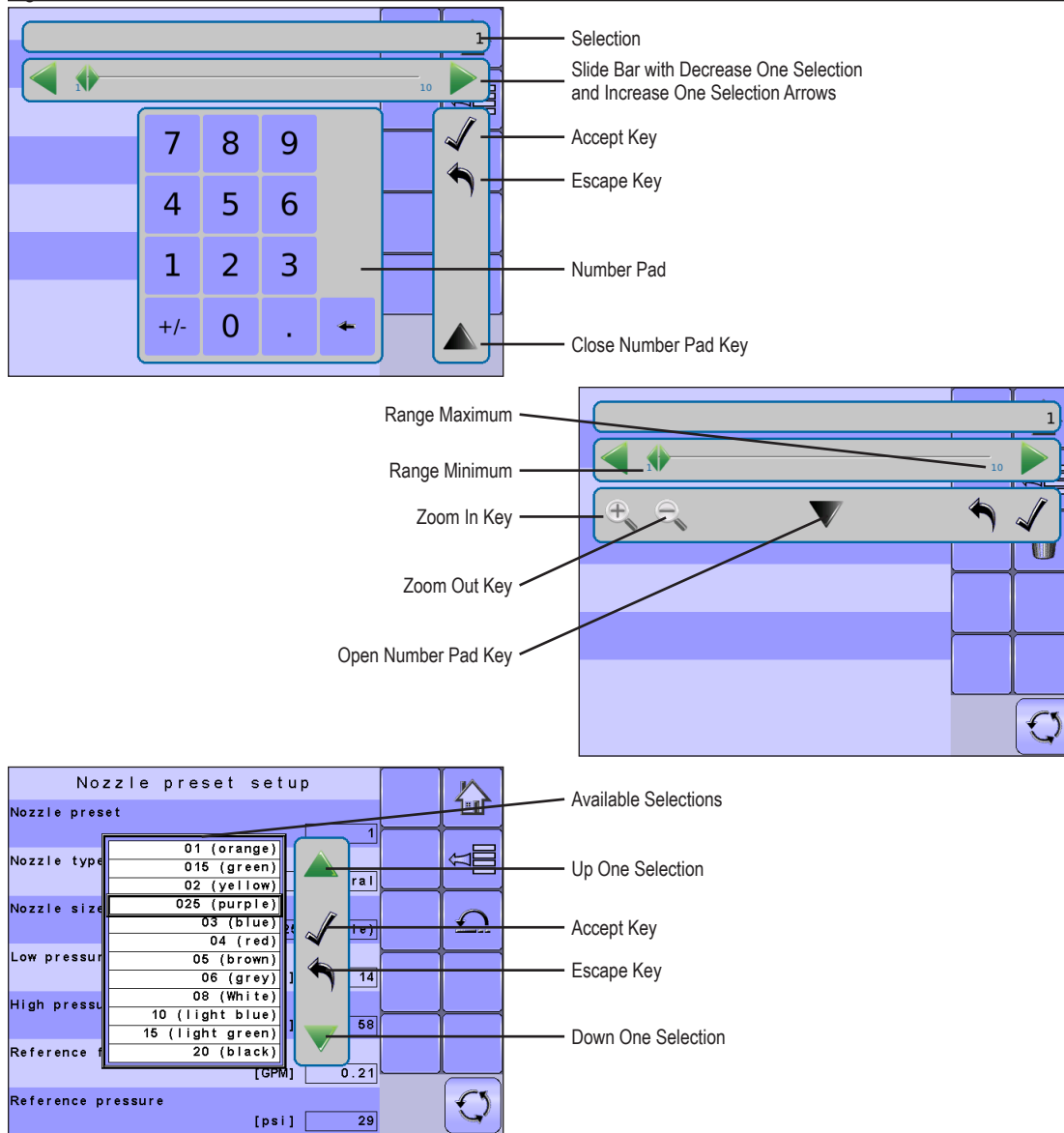



ISOBUS Job Computer : IC18 Sprayer

Main Setup Menu Icons and Section Overviews

Figure 2-8: Enter Selection Screens



ISOBUS Job Computer : IC18 Sprayer

Section or Icon	Description
Accept Key 	Accepts the new selection
Close Number Pad Key 	Minimizes the number pad
Decrease One Selection Arrow 	Decreases the setting
Down One Selection Arrow 	Highlights the selection below
Escape Key 	Escapes without saving changes
Increase One Selection Arrow 	Increases the setting
Number Pad	Use the numbers to set the selection value
Open Number Pad Key 	Maximizes the number pad
Selection	Displays the current or new selection
Slider 	Slide to the left to decrease or right to increase the selection
Slide Bar	Selects the setting by pressing and releasing on the slide bar or pressing and dragging the Slider to a designated value. Range for a specific setting is displayed on the slide bar.
Up One Selection Arrow 	Highlights the selection above
Zoom In Key 	Narrows slide bar range. Gray = maximum zoom level.
Zoom Out Key 	Expands slide bar range. Gray = minimum zoom level.

ISOBUS Job Computer : IC18 Sprayer

OVERVIEW

GETTING STARTED

SETUP

OPERATION

APPENDIX

CHAPTER 3 – MAIN SETUP IN SPRAYER MODE

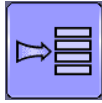

Main Setup Mode configures the Counters, Job Parameters, Machine, User Interface, Communication and Help options.

NOTE: The menu structure on your display might vary from the one displayed in this User Manual depending on the virtual terminal being used.

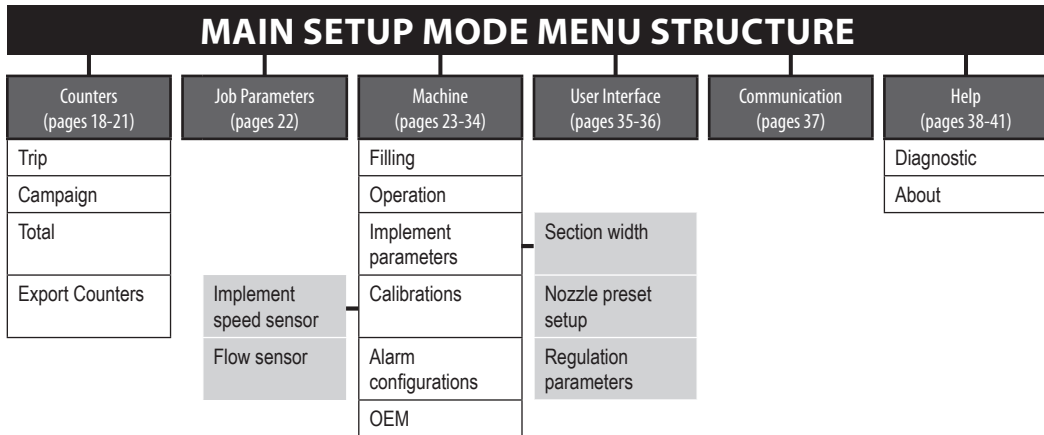
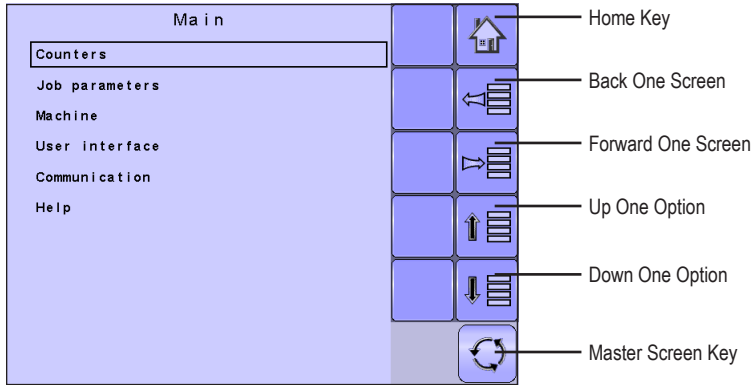

Figure 3-1: Main Setup Screen





The OEM setup menu is password protected and the settings in this menu are directly related to the fitted OEM equipment. Refer to the IC18 Sprayer/NH3 OEM Setup Manual for information regarding OEM settings.

ISOBUS Job Computer : IC18 Sprayer

Main Setup Screen

NOTE: Settings are NOT automatically saved when selected. The ACCEPT KEY  must be selected to save the setting. Select the ESCAPE KEY  to escape without saving settings and return to the previous menu.

To access the Main Setup screens:

1. Select IC18 SPRAYER KEY  from the Master Screen.
2. Select MAIN SETUP SCREEN KEY  from the Home Screen.
3. Select from:
 - ▶ Counters – used to provide an overview of various system counters:
 - ◀ Trip – used to display information regarding area, distance, time and amount applied.
 - ◀ Campaign – used to display information regarding area, amount applied and time for all trips
 - ◀ Total – used to display information regarding area, amount applied, and time for all activity
 - ◀ Export Counters – allows counter information to be exported in HTML or CSV format
 - ▶ Job Parameters – used to configure application settings including active trip counter, application rate and nozzle type.
 - ▶ Machine – used to configure machine settings:
 - ◀ Filling – establishes the amount of material remaining in the tank and the density of that material.
 - ◀ Operation – establishes Application Rate Step, Speed Source, and Simulated Speed
 - ◀ Implement Parameters – establishes the Section Width, Nozzle Preset Setup and Regulation Parameters
 - ◀ Calibrations – establishes either manual or automatic settings of the sensors
 - ◀ Alarm Configurations – establishes alarms for CAN Speed Source Timeout, Active Trip Count Information mode and Tank Content Minimum
 - ◀ OEM – The OEM setup menu is password protected and the settings in this menu are directly related to the fitted OEM equipment. Refer to the OEM Setup Manual for information regarding OEM settings.
 - ▶ User Interface – used to allow the operator to select the system virtual terminal (VT), switchbox pairing, BoomPilot ECU pairing and soft key numbering as well as view serial numbers and ECU identification numbers:
 - ▶ Communication – used to establish the IC18's ability to communicate with an external computer:
 - ▶ Help – allows the operator to choose between Diagnostics and the About screen:
 - ◀ Diagnostic – used to troubleshoot input/output of the controller (sensor or actuator).
 - ◀ About – used to provide information on the console such as software version, build number, etc

NOTE: The menu structure on your display might vary from the one displayed in this User Guide depending on the virtual terminal being used. This User Guide will display all possible options.

Master Screen



The Master Screen gives access to the systems currently available on your VT.

- To view the Master Screen options, select MASTER SCREEN KEY  in bottom right corner of any screen.

Figure 3-2: Master Screen



Master Screen Key on Main Setup Screen

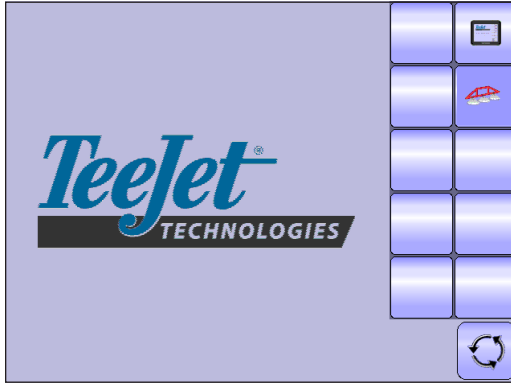
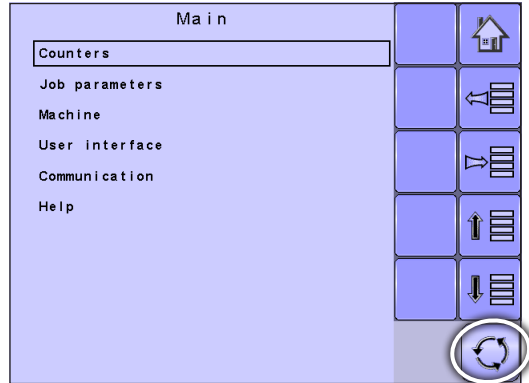

Home Screen



The Home Screen gives access to the IC18's available functions: Operation Mode, Transport Mode and Main Setup.

- To view the Home Screen, select HOME KEY  in the top right corner of any screen.

Figure 3-3: Home Screen

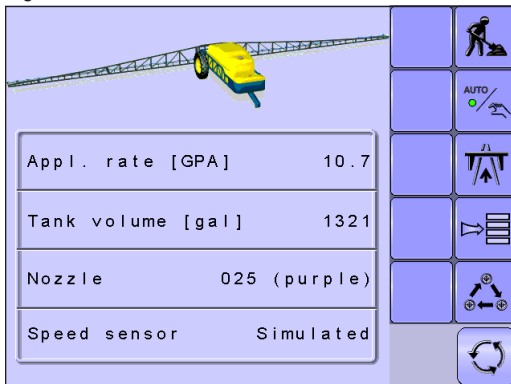

Home Key on Main Setup Screen

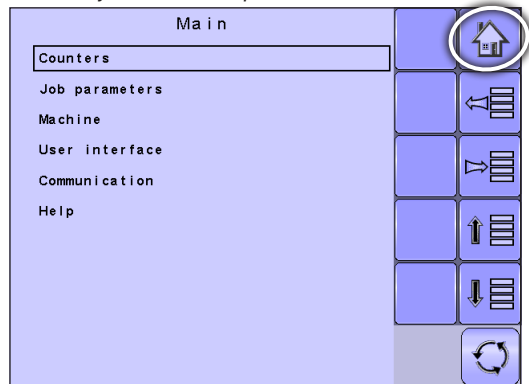

ISOBUS Job Computer : IC18 Sprayer

COUNTERS

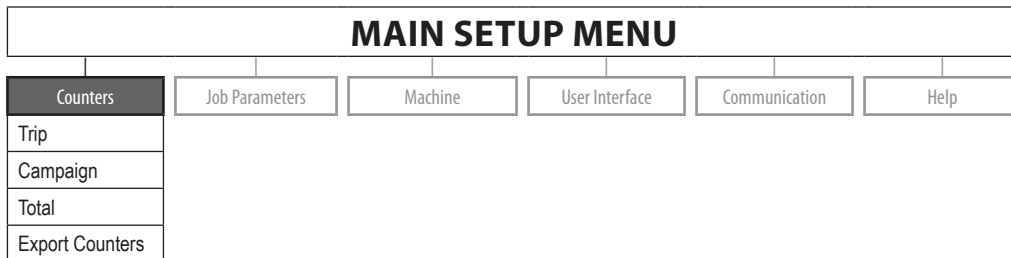

The Counters Menu provides an overview of various system counters including Trip Counters, Campaign Counters and Total Counters. From this screen one can also Export Counters.



1. From the Main Setup Screen , select COUNTERS. *Figure 3-4: Counters*

2. Select from:

- ▶ Trip – used to display information regarding area, distance, time and amount applied
- ▶ Campaign – used to display information regarding area, amount applied and time for all trips
- ▶ Total – used to display information regarding area, amount applied, and time for all activity
- ▶ Export Counters – allows counter information to be exported in HTML or CSV format

NOTE: Settings are NOT automatically saved when selected. The ACCEPT KEY  must be selected to save the setting. Select the ESCAPE KEY  to escape without saving settings and return to the previous menu.

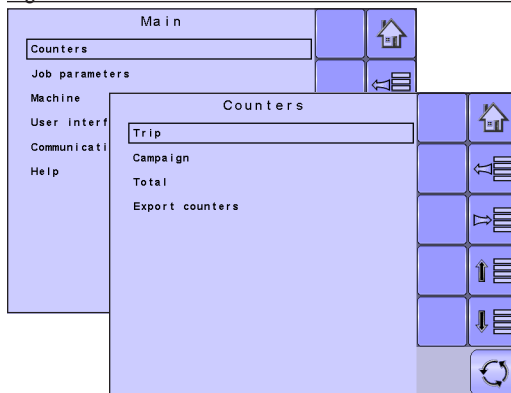

Trip Counters

Trip Counters displays information regarding area, distance, time and amount applied. The trip that is active is displayed/active on the Operations Screen.

Active Trip Counter

One of up to ten (10) Active Trip Counters can be selected to view the desired trip information. The trip that is “active” is displayed/active on the Operation Screen.

- To select the Active Trip Counter, use the number pad or slide bar.
- To clear the Trip Counters, select TRASH CAN KEY . A confirmation screen will be displayed.

Area Counter

Displays applied coverage area for the selected Active Trip.

Distance Counter

Displays distance traveled for the selected Active Trip.

Time Counter

Displays time traveled for the selected Active Trip.

Volume Counter

Displays volume of material applied during the selected Active Trip.

Figure 3-5: Trip Counters Menu

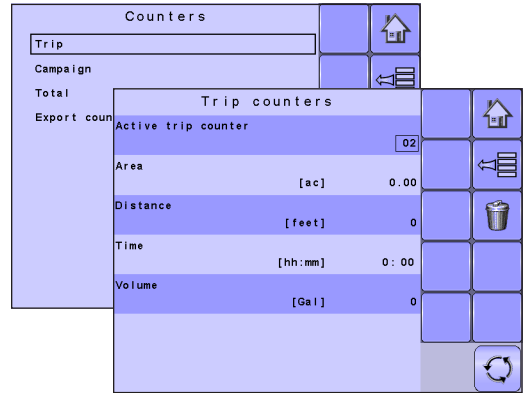
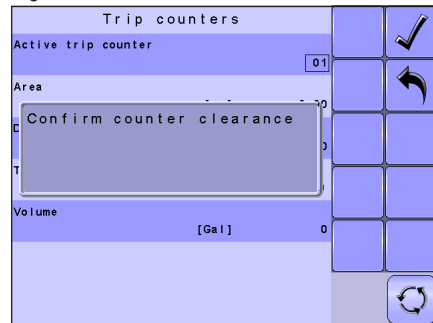



Figure 3-6: Confirm Counter Clearance



ISOBUS Job Computer : IC18 Sprayer

Campaign Counters

Campaign Counters display information regarding area, amount applied and time for all trips.

- To clear the Campaign Counters, select TRASH CAN KEY . A confirmation screen will be displayed.

Area Counter

Displays total applied coverage area for all trips.

Volume Counter

Displays total volume of material applied during all trips.

Time Counter

Displays total time traveled for all trips

Figure 3-7: Campaign Counters

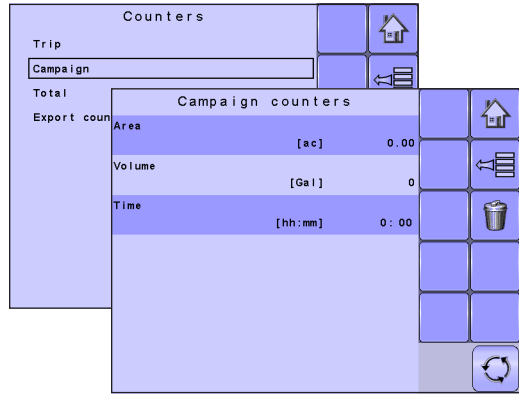

Figure 3-8: Confirm Campaign Clearance

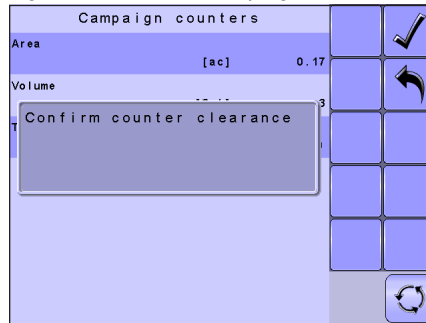
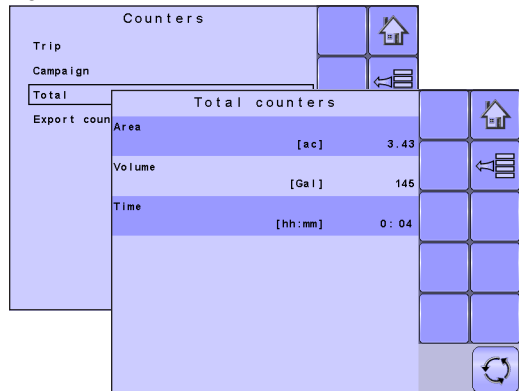

Figure 3-9: Total Counters



Total Counters

Total Counters displays information regarding area, amount applied, and time for all activity. Total Counters can only be cleared in the OEM menu.

Area Counter

Displays total applied coverage area for all trips.

Volume Counter



Displays total volume of material applied during all trips.

Time Counter

Displays total time traveled for all trips.

Export Counters

Export Counters allows counter information to be exported in HTML or CSV format. HTML files can be viewed from an internet browser. CSV files can be viewed as Excel sheets.

- To export a HTML file, select HTML KEY . A confirmation screen will be displayed.
- To export a CSV file, select CSV KEY . A confirmation screen will be displayed.

For data transfer, an optional cable is required. Contact your local dealer for additional information.

Figure 3-10: Export Counters

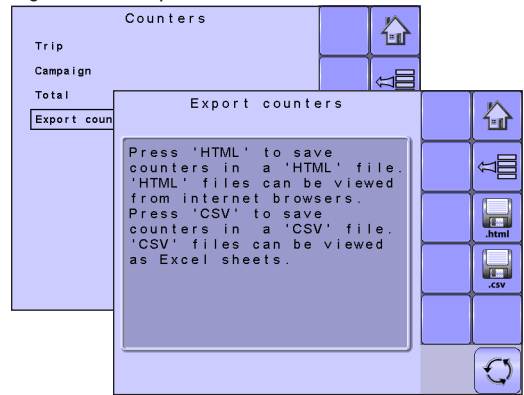
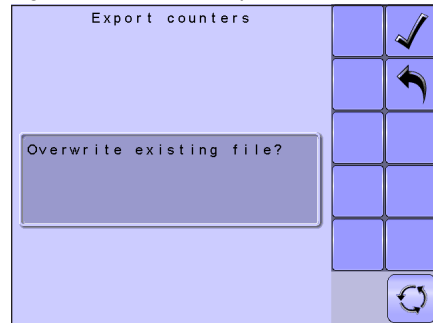

Figure 3-11: Confirm Export Counters





ISOBUS Job Computer : IC18 Sprayer

JOB PARAMETERS

Job Parameters configures application settings. Options include Active Trip Counter, Preset Application Rates and Nozzle.



1. From the Main Setup Screen , select JOB PARAMETERS.

NOTE: Settings are NOT automatically saved when selected. The ACCEPT KEY  must be selected to save the setting. Select the ESCAPE KEY  to escape without saving settings and return to the previous menu.

Active Trip Counter

Active Trip Counter selects one of up to ten (10) active trip counters to view the desired trip information. The trip that is “active” is displayed/active on the Operation Screen.

- To select the Active Trip Counter, use the number pad or slide bar.

NOTE: The selected trip counter will have all data modified (added too) when additional operations are activated. If current trip counter is not cleared, the new data will be added to the existing data.

Preset Application Rates

Preset Application Rates define up to five (5) target rates of product being applied per hectare/acre. These settings will set the same for all active trips. Target rates set to "0.0" will not be included in the TOGGLE PRESET TARGET RATE options  on the Operation Screen or Home Screen.

- To select the Application Rate, use the number pad or slide bar.

Nozzle

Nozzle selects the nozzle type. This setting will set the same for all active trips. The five (5) available nozzle types are preset under Main --> Machine --> Implement Parameters --> Nozzle Preset Setup.

- To select the Nozzle type, select an option from the drop down menu or use the UP/DOWN ARROWS to highlight the option.

Figure 3-12: Job Parameters

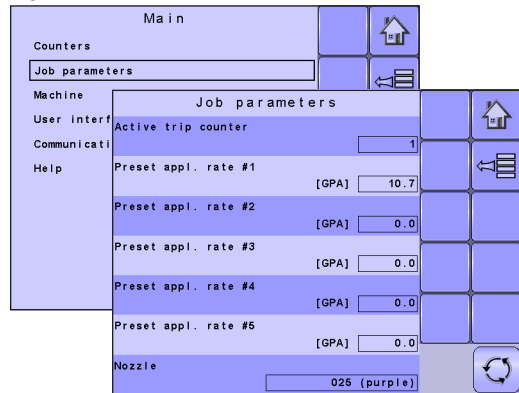

MACHINE

Machine configures machine settings. Options include Filling, Operation, Implement Parameters, Calibrations, Alarm Configurations and OEM.

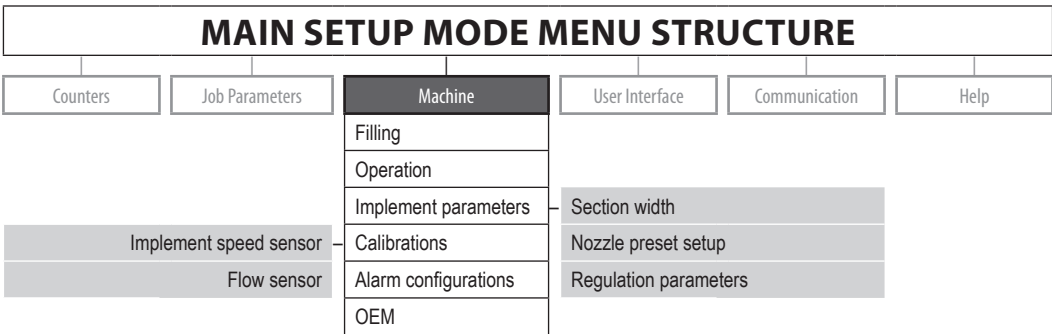



The OEM setup menu is password protected and the settings in this menu are directly related to the fitted OEM equipment.

1. From the Main Setup Screen , select MACHINE.
2. Select from:

- ▶ Filling – establishes the amount of material remaining in the tank and the density of that material.
- ▶ Operation – establishes Application Rate Step, Speed Source, and Simulated Speed.
- ▶ Implement Parameters – establishes the Section Width, Nozzle Preset Setup and Regulation Parameters.
- ▶ Calibrations – establishes either manual or automatic settings of the sensors.
- ▶ Alarm Configurations – establishes alarms for CAN Speed Source Timeout, Active Trip Count Information mode and Tank Content Minimum
- ▶ OEM – The OEM setup menu is password protected and the settings in this menu are directly related to the fitted OEM equipment. Refer to the OEM Manual for information regarding OEM settings.

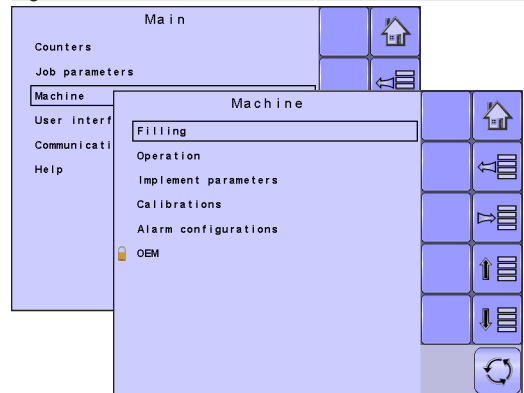
Figure 3-13: Machine



NOTE: Settings are NOT automatically saved when selected. The ACCEPT KEY  must be selected to save the setting. Select the ESCAPE KEY  to escape without saving settings and return to the previous menu.

ISOBUS Job Computer : IC18 Sprayer

Filling

Filling establishes the amount of material remaining in the tank and the density of that material.

Different options will be available depending on if a tank sensor is installed.

NOTE: The size of the tank is established in the OEM menu. This is the number that will repopulate when the Full Tank Key  is pressed.

Actual Content

Actual Content displays the current volume of content in the tank. The volume can be manually adjusted.

- To adjust the volume, use the number pad or slide bar.

NOTE: When a tank sensor is active, the actual content can not be changed manually.

Density

Density establishes the density of the material being applied. It can be set to either “fertilizer” or “water”.

- To select the Density, select an option from the drop down menu or use the UP/DOWN ARROWS to highlight the option.

NOTE: If “Fertilizer” is selected, a Density Factor option appears.

Density Factor

Density Factor establishes the weight per volume setting based on the type of fertilizer being used.

- To select the Density Factor, use the number pad or slide bar.

The fertilizer’s ability to flow is affected by a number of factors. These factors may vary with each batch and it may change due to weather (humidity, etc.). In order to accommodate for this, the job computer uses a density factor to compensate for the nature of the applied fertilizer.

Full Tank

Full Tank returns the Actual Content volume value to the maximum volume of the tank

- To reset the Actual Content value, press the FULL TANK KEY  .

Figure 3-14: Filling

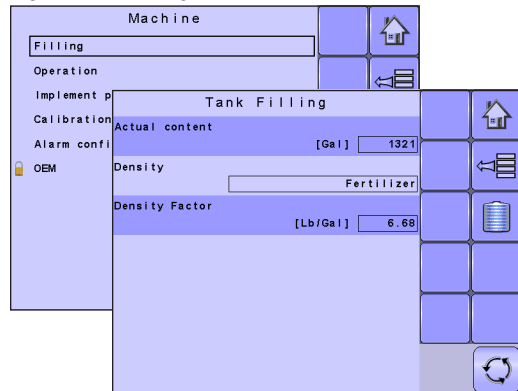

Operation

Operation establishes Application Rate Step, Speed Source and Simulated Speed.

Application Rate Step

Application Rate Step is the percent of increase/decrease “boost” of the active application rate at which the product is being applied.

- To select the percentage, use the number pad or slide bar.

Speed Source

Speed Source selects whether to base the machine’s speed on input from the CAN, an Implement or a Simulated source. Selecting “Implement” will allow for the configuration of pulses per 300 feet / 100 meters. Selecting “Simulated” will allow for simulated speed to be entered using the “Edit Value” option. Selecting “CAN” allows for speed being supplied by the ISOBUS CAN (usually from the TECU) to be used.

- To select the Speed Source, select an option from the drop down menu or use the UP/DOWN ARROWS to highlight the option.

NOTE: If “Implement” is selected, refer to the Calibrations section for further instructions.

Simulated Speed

Simulated Speed establishes a speed to be used when using the Simulated Speed source.

- To select the Simulated Speed, use the number pad or slide bar.

Figure 3-15: Operation

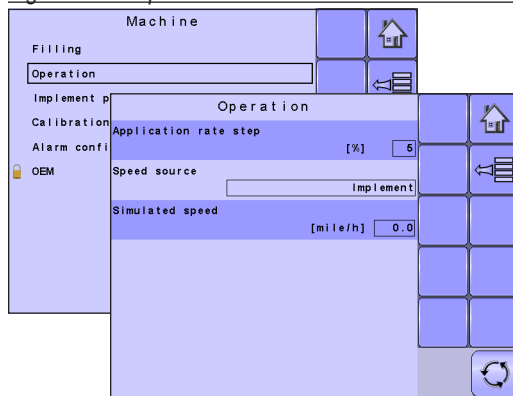
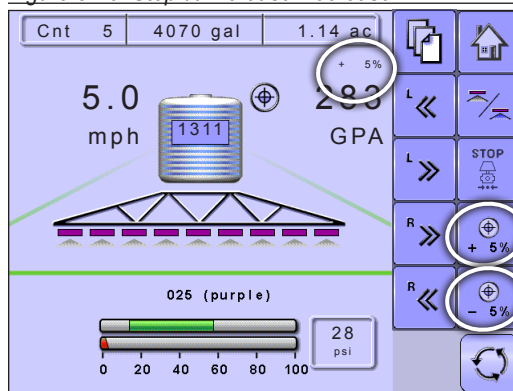

Figure 3-16: Step % Increase/Decrease



Implement Parameters

Implement Parameters establishes the following:

- ▶ Section Width – sets the spraying width during application.
- ▶ Nozzle Preset Setup – where up to five (5) sets of nozzle options can be established to set the nozzle type, size, low/high pressure limit, reference flow and reference pressure.
- ▶ Regulation Parameters – where adjustments to the valve calibration, nozzle spacing and regulations mode can be established.

Figure 3-17: Implement parameters

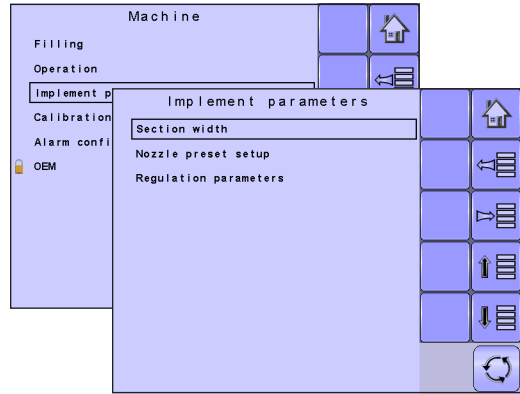

Section Width

Section Width sets the spraying width during application.

Boom Section Width

Section Width establishes the boom sections widths for each boom section.

NOTE: The number of boom sections available is set on the Implement Parameters screen in the OEM section.

- To select the Boom Section Width, use the number pad or slide bar.

When the section widths are changed, power must be cycled in order to update the TASC Controller on the VT.

Figure 3-18: Section Width

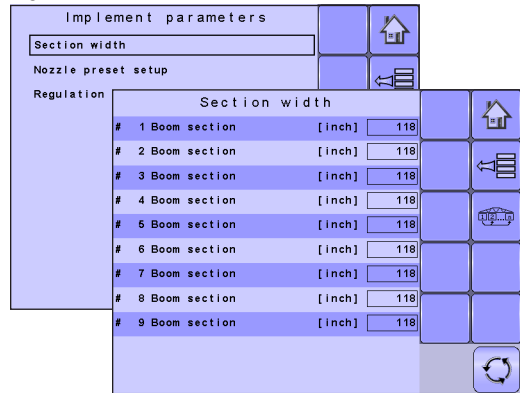

One-Touch Equal Widths

One-Touch Equal Widths sets all boom section widths to the value set for #1 Boom Section.

- To set all boom section widths, press the EQUAL SECTION WIDTH KEY .

Nozzle Preset Setup

Nozzle Preset Setup establishes up to five (5) sets of nozzle options setting the nozzle type, size, low/high pressure limit, reference flow and reference pressure.

Nozzle Preset

Each one of up to five (5) Nozzle Presets can be selected to establish different sets of nozzle options.

- To select the Nozzle Preset set, use the number pad or slide bar.

Nozzle Type

Nozzle Type sets whether the nozzle's size will be selected from a general section of established tips or a optional user tip.

- To select the Nozzle Type, select an option from the drop down menu or use the UP/DOWN ARROWS to highlight the option.

Nozzle Size

Nozzle Size sets the nozzle from a list of established sizes (see chart below) or from a optional user tip.

- To select the Nozzle Size, select an option from the drop down menu or use the UP/DOWN ARROWS to highlight the option.

Established Nozzle Sizes and Colors			
Size	Color	Size	Color
01	Orange	05	Brown
015	Green	06	Grey
02	Yellow	08	White
025	Purple	10	Light Blue
03	Blue	15	Light Green
04	Red	20	

When "General" nozzle type is selected and a established nozzle size is selected, the Low Pressure Limit, High Pressure Limit, Reference Flow and Reference Pressure fields will be automatically set with the standard settings for the specific nozzle chosen. These setting can be manually adjusted.

Figure 3-19: Nozzle Preset Setup

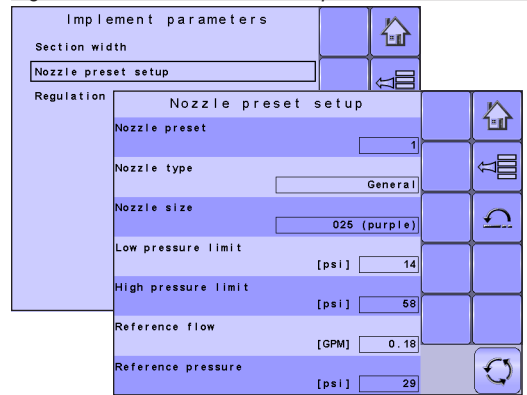
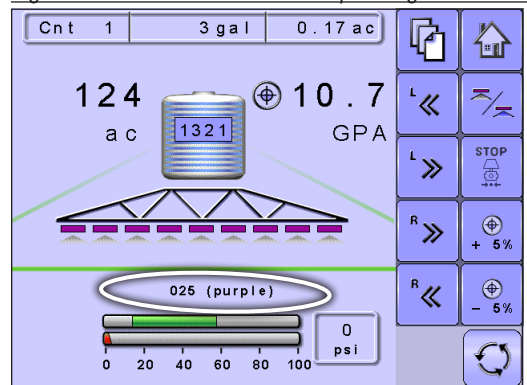

Figure 3-20: Nozzle Size on the Operating Screen



ISOBUS Job Computer : IC18 Sprayer

Low Pressure Limit

Low Pressure Limit establishes the limit for the lowest allowed operating pressure for the selected nozzle type.

- To select the Low Pressure Limit, use the number pad or slide bar.

High Pressure Limit

High Pressure Limit establishes the limit for the highest allowed operating pressure for the selected nozzle type.

- To select the High Pressure Limit, use the number pad or slide bar.

Reference Flow

Reference Flow establishes the value for the volume applied over a specific time (GPM or LPM).

- To select the Reference Flow, use the number pad or slide bar.

Reference Pressure

Reference Pressure establishes the pressure value at which the application rate is true (ISO=2 bar).

- To select the Reference Pressure, use the number pad or slide bar.

IMPORTANT! Always refer to the nozzle pressure values recommended by the supplier when setting the nozzle pressure.

Factory Settings

Factory Settings resets all nozzle settings to the default settings for the selected nozzle size and type.

- To reset the Factory Settings, select FACTORY SETTINGS KEY . A confirmation screen will be displayed.

Figure 3-21: Recommended Pressure Range bar and High Pressure Limit on the Operating Screen

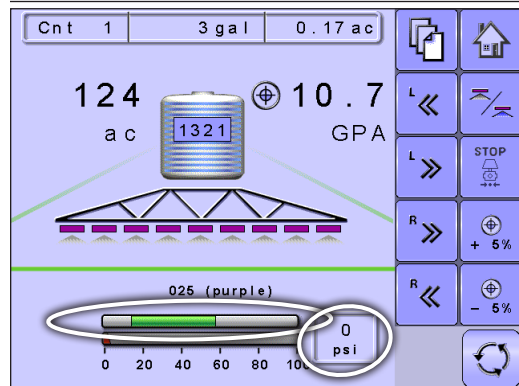
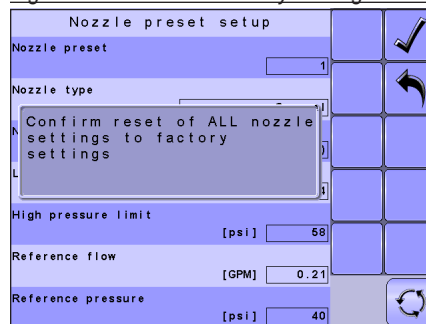

Figure 3-22: Confirm Factory Settings



Regulation Parameters

Regulation Parameters establishes adjustments to the valve calibrations, nozzle spacing and regulations mode.

NOTE: Adjusting the Valve Calibration settings involves significant changes and adjustments should therefore be made in small steps.

Valve Calibration, Rough

Rough regulation value calibration allows you to regulate the setting of the regulating valve to accommodate different application needs. Operating conditions may necessitate a higher or lower response setting for the regulating valve. This value adjusts the setting for coarse adjustments in relation to a large percentage outside of the target application rate

- ▶ If the system is too slow in finding the correct rate, the values should be increased.
- ▶ If the system is too unstable, the values should be decreased.
 - To select the Valve Calibration, Rough, use the number pad or slide bar.

If your system is plumbed in a bypass mode, the valve setting number of 9 works very well in most applications. If your system is plumbed in a throttling mode, start with a valve setting number of 3 and adjust the number according to your application requirements. Low flow situations will require a slower response time. Adjusting agitation volumes to accommodate the regulating valve to work in a more fully open position allows for a faster response time, with little to no searching.

NOTE: This setting value can be adjusted to optimize system performance. If you notice that the valve seems to “search” for the programmed application rate by cycling the pressure up and down continuously, reduce the number until the “searching” is minimized or eliminated. Conversely, a higher number will increase the valve response time and “speed up” the rate of adjustment.

Valve Calibration, Fine

Fine regulation value calibration allows you to regulate the setting of the regulating valve to accommodate different application needs. Operating conditions may necessitate a higher or lower response setting for the regulating valve. This digit adjusts the setting for the fine tune adjustment in relation to a small percentage close to the target application rate.

- ▶ If the system is too slow in finding the correct rate, the values should be increased.
- ▶ If the system is too unstable, the values should be decreased.
 - To select the Valve Calibration, Fine, use the number pad or slide bar.

If your system is plumbed in a bypass mode, the valve setting number of 5 works very well in most applications.

Figure 3-23: Regulation Parameters

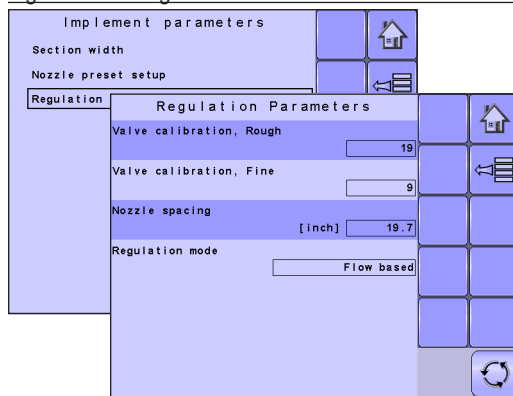

ISOBUS Job Computer : IC18 Sprayer

If your system is plumbed in a throttling mode, start with a valve setting number of 3 and adjust the number according to your application requirements. Low flow situations will require a slower response time. Adjusting agitation volumes to accommodate the regulating valve to work in a more fully open position allows for a faster response time, with little to no searching.

NOTE: This setting value can be adjusted to optimize system performance. If you notice that the valve seems to “search” for the programmed application rate by cycling the pressure up and down continuously, reduce the number until the “searching” is minimized or eliminated. Conversely, a higher number will increase the valve response time and “speed up” the rate of adjustment.

Nozzle Spacing

Nozzle Spacing establishes the distance between the nozzles on the boom.

- To select the Nozzle Spacing, use the number pad or slide bar.

Regulation Mode

Regulation Mode determines if the rate control is pressure based or flow based.

- To select the Regulation Mode, select an option from the drop down menu or use the UP/DOWN ARROWS to highlight the option.

Calibrations

Calibrations establishes either manual or automatic settings of the sensors.

NOTE: For specific calibration options to appear, a specific sensor needs to be installed. Sensor availability is activated on the Sensor Presence screen in the OEM section.

Implement Speed Sensor

The Implement Speed Sensor establishes the wheel pulses over a specified distance. This value can be established manually or calibrated automatically.



Manual Calibration

Manual calibration establishes the pulses based on a user entered value.

- To select the Pulses per Distance, use the number pad or slide bar.

Automatic Calibration

Automatic calibration establishes the pulses using the automatic calibration function.

- To calibrate the pulses per distance, select CALIBRATION KEY .
- Follow the series of instructions displayed.
- Select the ACCEPT KEY  to complete the calibration

The counted wheel pulses will be displayed during the automatic calibration.

Figure 3-24: Calibrations

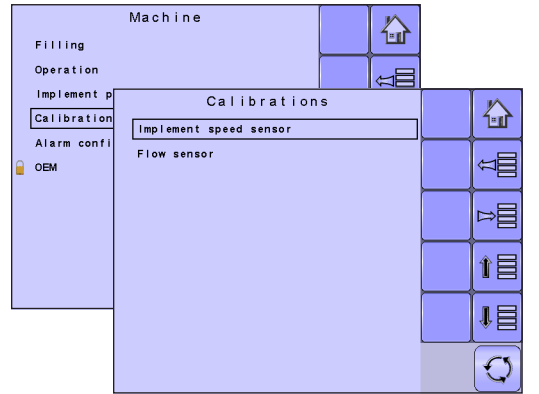
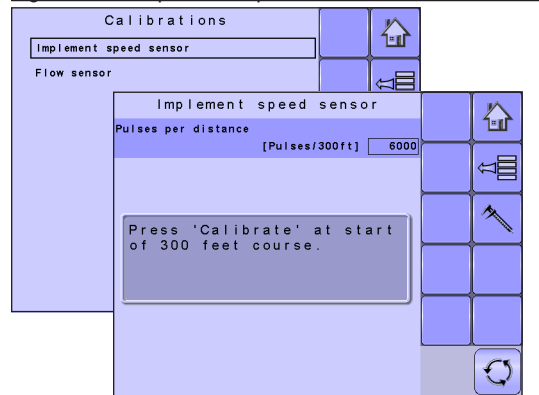

Figure 3-25: Implement Speed Sensor



ISOBUS Job Computer : IC18 Sprayer

Flow Sensor

The Flow Sensor establishes the pulses per gallon/liter. This value can be established manually or calibrated automatically.

Manual Calibration

Manual calibration establishes the calibration and limits based on user entered values.

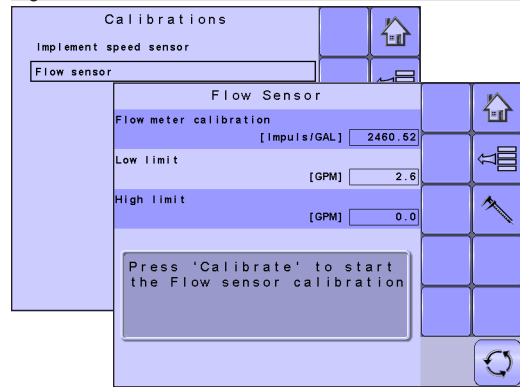

- To select the Flow Meter Calibration, use the number pad or slide bar.
- To select the Low Limit, use the number pad or slide bar.
- To select the High Limit, use the number pad or slide bar.

Figure 3-26: Flow Sensor



Automatic Calibration

If the number of pulses per gallon/liter for the flow meter is not known or to make sure the value is correct, automatic calibration establishes the calibration and limits.

- To calibrate the flow sensor, select CALIBRATION KEY .
- Follow the series of instructions displayed.
- Select the ACCEPT KEY  to complete the calibration

The pulses counted will be displayed during the automatic calibration.

An option to enter a Collected Volume is displayed if there is no calculated volume.

- To enter the Collected Volume, use the number pad or slide bar.

Alarm Configurations

Alarm Configurations establishes alarms on or off as well as sets their trigger level.

CAN Speed Source Timeout

CAN Speed Source Timeout establishes how long the system can operate after the CAN speed source input is lost before the alarm is triggered.

- To select the CAN Speed Source Timeout time, use the number pad or slide bar.

Active Trip Count Information

Active Trip Count Information sets the associated alarm to on or off. This alarm is only displayed at powered up. It tells the user which trip counter is active.

- To select the Active Trip Count Information mode, select an option from the drop down menu or use the UP/DOWN ARROWS to highlight the option.

Tank Content Minimum

Tank Content Minimum establishes the minimum volume level at which an alarm will sound. Without a Tank Sensor, the minimum is determined by calculating the difference between the established actual tank content volume and the calculated applied content volume. With a Tank Sensor, the minimum is directly related to the sensor reading.

- To select the minimum volume, use the number pad or slide bar.

Figure 3-27: Alarm Configurations

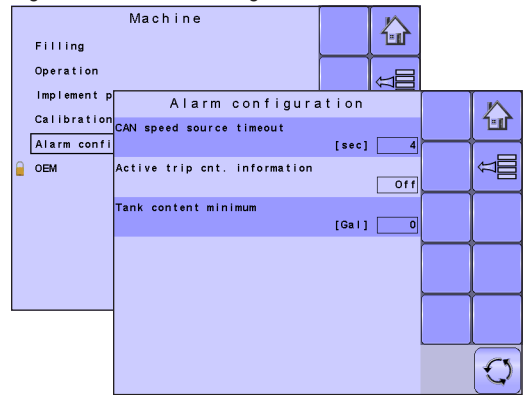



ISOBUS Job Computer : IC18 Sprayer

OEM

The OEM setup menu is password protected and the settings in this menu are directly related to the fitted OEM equipment. To obtain an access code, contact your local dealer or TeeJet Technologies Customer Service.

To access the OEM screens:

1. From the Main Setup Screen , select MACHINE.
2. Select OEM.
3. Select the Access Code Entry Box to the right of the menu option.
4. Use the number pad or slide bar to enter the access code.
5. Select the ACCEPT KEY  to complete the unlock process
6. Select from:
 - ▶ Sensor presence – used to establish sensors for Flow, Liquid Pressure, Fill Flow and the Tank
 - ▶ Implement parameters – used to establish the Sprayer Mode, Number of Sections and Circulation
 - ▶ Valve setup – used to establish the Regulation Valve Type, Section Valve Behavior and Section Valve Type
 - ▶ Tank setup – used to establish maximum and minimum tank content, Auto Filling mode and Auto Filling Offset value
 - ▶ Regulation details – used to adjust the control of the regulation valve
 - ▶ Clear total counters – used to delete the Total Count system counter for Area, Volume and Time back to the default settings



NOTE: Settings are NOT automatically saved when selected. The ACCEPT KEY  must be selected to save the setting. Select the ESCAPE KEY  to escape without saving settings and return to the previous menu. OEM

Figure 3-28: Machine to OEM

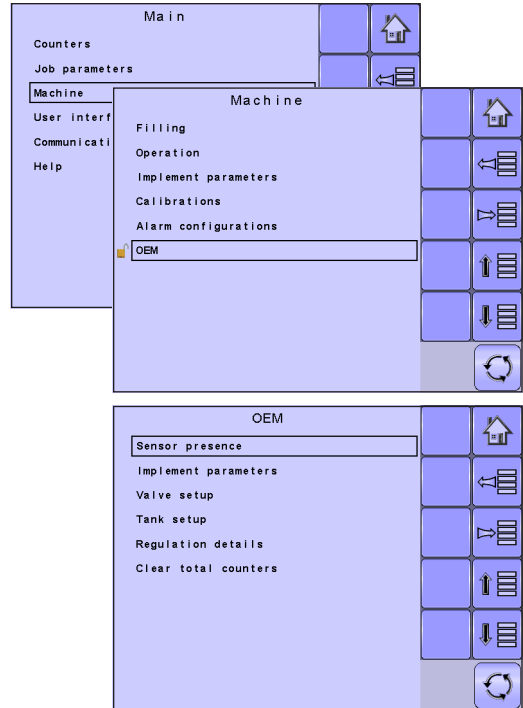
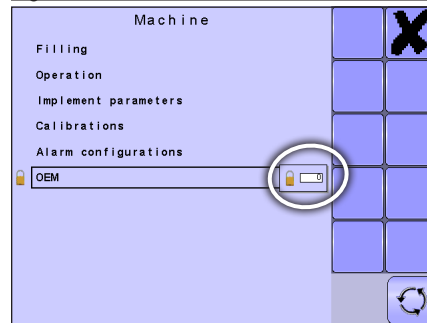



Figure 3-29: OEM Unlock





USER INTERFACE

User Interface allows the operator to select the system virtual terminal (VT), switchbox pairing, BoomPilot ECU pairing and soft key numbering as well as view serial numbers and ECU identification number.



1. From the Main Setup Screen , select USER INTERFACE.

NOTE: Settings are NOT automatically saved when selected. The ACCEPT KEY  must be selected to save the setting. Select the ESCAPE KEY  to escape without saving settings and return to the previous menu.

Use Preferred VT

Use Preferred VT sets the virtual terminal preference to either on or off. If “On” is selected, the preferred VT will be used. If “Off” is selected, the system will arbitrarily select which VT to use (if more than one VT is available on the ISOBUS CAN).

NOTE: This should always be set to “off” unless another VT is on the CAN bus.

- To set the Use Preferred VT mode, select an option from the drop down menu or use the UP/DOWN ARROWS to highlight the option.

This IC18

Displays IC18’s serial number and associated ECU identification number.

Pair with Switchbox

The pairing of a switchbox can be set to be done automatically, not at all or to a specific switchbox ECU ID number on the CAN network.

- To set the Switchbox pairing, select an option from the drop down menu or use the UP/DOWN ARROWS to highlight the option.

Pair with BoomPilot ECU

The pairing of a BoomPilot ECU can be set to be done automatically, not at all or to a specific BoomPilot ECU ID number on the CAN network.

Figure 3-30: User Interface

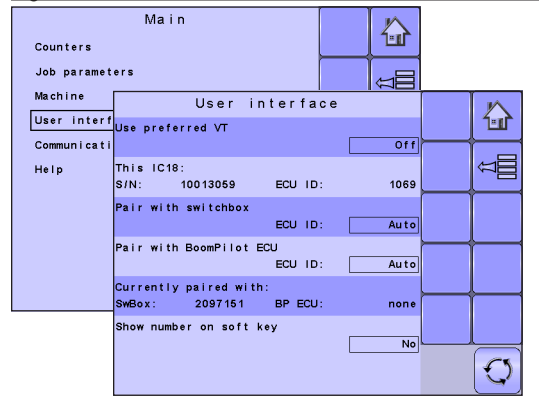

ISOBUS Job Computer : IC18 Sprayer

- To set the BoomPilot ECU pairing, select an option from the drop down menu or use the UP/DOWN ARROWS to highlight the option.

Currently Paired With Information

Displays the current ECU ID numbers for a paired switchbox or BoomPilot ECU.

- If no switchbox or BoomPilot ECU is on the system, "none" will be shown.
- If a specific switchbox or BoomPilot ECU has been chosen to be paired with and it is not available on the system, "none" will be shown.

Show Number on Soft Key

Show Number on Soft Key establishes if a user assigned identification number will be visible on the Master Screen, Home Screen and Operation Screen.

- To set the Soft Key Number mode, select an option from the drop down menu or use the UP/DOWN ARROWS to highlight the option.

NOTE: Typically used only if more than one (1) IC18 ECU is on the CAN bus.

If "Yes" is selected, a Sprayer Number (FI) option appears.

Sprayer Number (FI)

Sprayer Number is the identification number referring specifically to the IC18 ECU referenced under the "This IC18" information row on the User Interface screen.

- To set the Sprayer Number, use the number pad or slide bar.

Figure 3-31: Sprayer Number

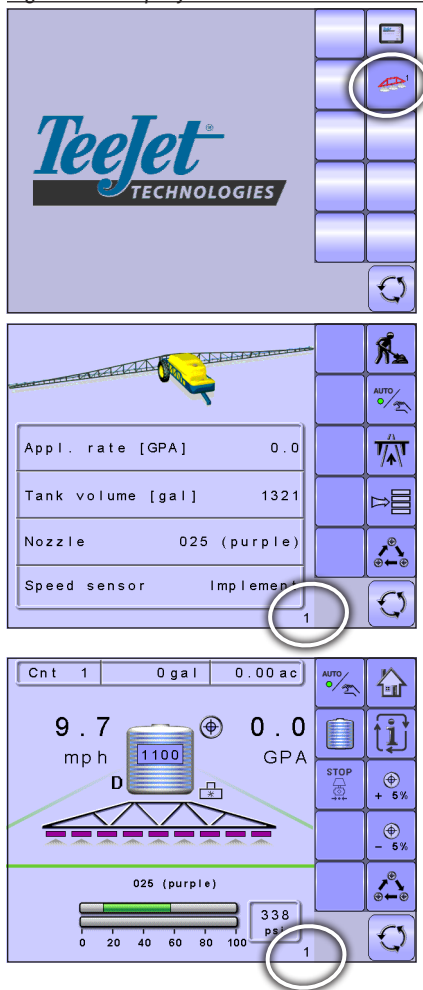

COMMUNICATION

Communication establishes the IC18's ability to communicate with an external computer.



1. From the Main Setup Screen , select COMMUNICATION.

Figure 3-32: Communication

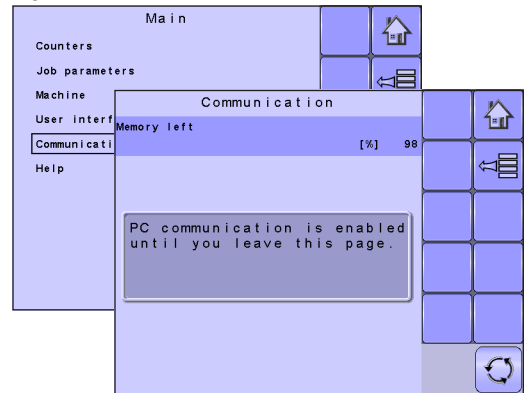

ISOBUS Job Computer : IC18 Sprayer

HELP

The Help menu allows the operator to choose between Diagnostics and the display of information about serial number, CAN BUS information, etc. These menus are typically accessed upon Customer Service personnel request only.

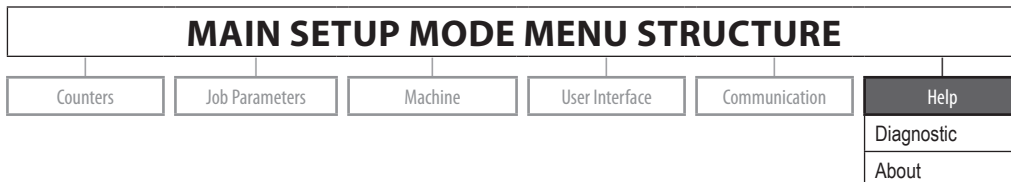

1. From the Main Setup Screen , select HELP.
2. Select from:
 - ▶ Diagnostic – used to troubleshoot input/output of the controller (sensor or actuator).
 - ▶ About – provides information on the console such as software version, build number, etc.



NOTE: Settings are *NOT* automatically saved when selected. The **ACCEPT KEY**  must be selected to save the setting. Select the **ESCAPE KEY**  to escape without saving settings and return to the previous menu.

Figure 3-33: Help



Diagnostic

Diagnostic is used to troubleshoot input/output of the controller (sensor or actuator).

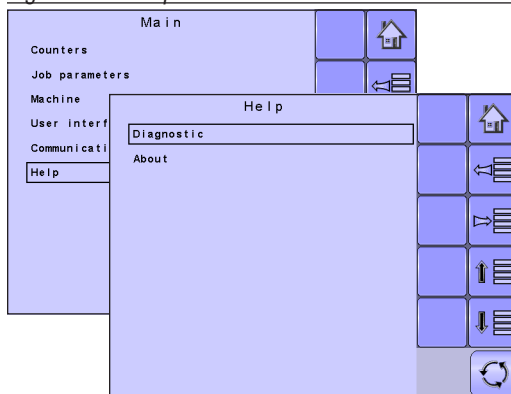
- ▶ Test Input – displays the input high and low values on the installed sensors.
- ▶ Test Output – sets the Liquid Valve PWM Dutycycle percentage as well as if Liquid Valve Direction, Master Valve, Fill Valve and Section Valves 1-9 are on or off.
- ▶ VT – provides information regarding the virtual terminal controller.
- ▶ TECU – provides information regarding the TECU.

Test Input

Test Input displays the input high and low values on the installed sensors.

- To reset the sensors to "0", select TRASH CAN KEY .

Figure 3-34: Diagnostic

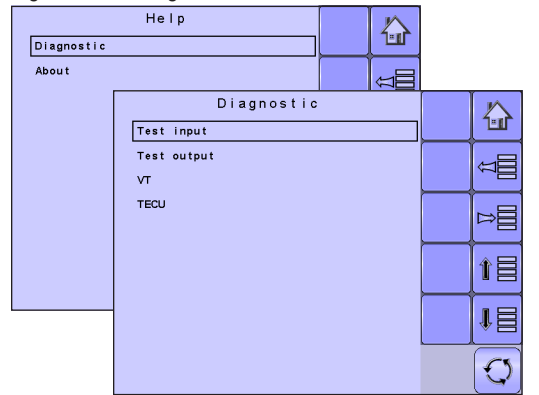
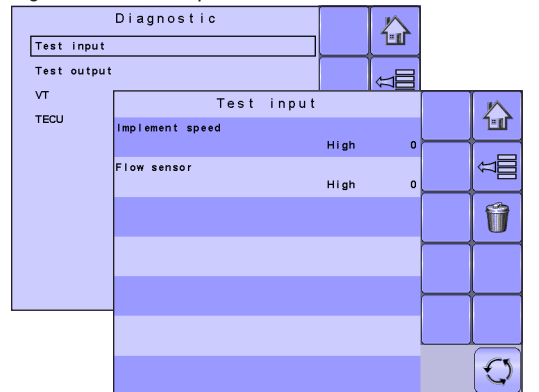

Figure 3-35: Test Input



ISOBUS Job Computer : IC18 Sprayer

Test Output

Test Output sets the Liquid Valve PWM Dutycycle percentage as well as if Liquid Valve Direction, Master Valve, Fill Valve and Section Valves 1-9 are on or off.

Liquid Valve PWM Dutycycle

Liquid Valve PWM Dutycycle is used to test the regulating valve at different percentages of duty cycle.

- To set the Liquid Valve PWM Dutycycle, use the number pad or slide bar.

Liquid Valve Direction

Liquid Valve Direction is used to verify the option of the Liquid valve direction is correct to a specific duty cycle.

- Set the Liquid Valve PWM dutycycle to the percentage to be tested.
- Change the Liquid valve direction to "on" and the liquid valve will open at the specific dutycycle.
- Change it back to off and the valve will close.

Master Valve

Master Valve is used to test if the Master Valve is operating correctly. If you change the setting to "on", the valve will open, change it to "off" and the valve will close.

- To set the Master Valve, select an option from the drop down menu or use the UP/DOWN ARROWS to highlight the option.

Section Valves

Section Valves is used to test if the section Valve is operating correctly. If you change the setting to "on", the valve will open, change it to "off" and the valve will close.

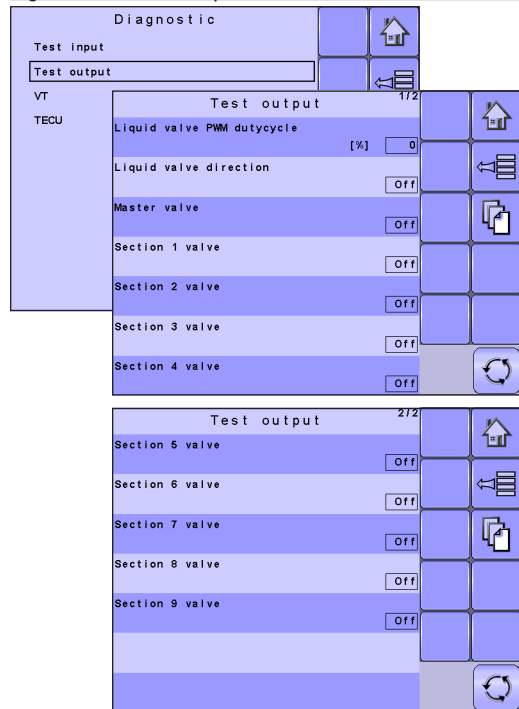

- To set the Section Valves, select an option from the drop down menu or use the UP/DOWN ARROWS to highlight the option.

Figure 3-36: Test Output



VT Data

The Virtual Terminal (VT) menu provides information regarding the virtual terminal controller (i.e., address version, etc.).

- If more terminals/controllers are used, switch between these by pressing the GO TO NEXT VT KEY .
- Press the DELETE OBJECT POOL KEY  to delete saved information on the VT. This forces the VT to upload all information from the IC18 on the next power cycle.

NOTE: Restart the IC18 Job Computer to implement and display changes.

Figure 3-37: VT Data

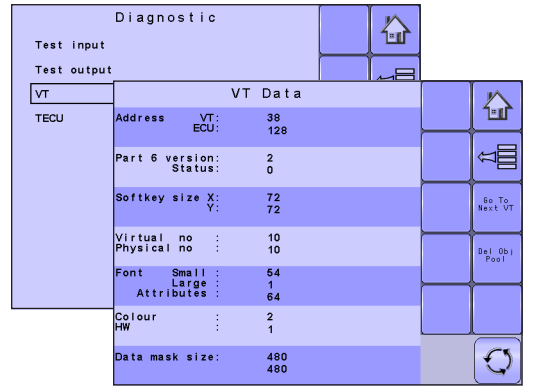

TECU

The TECU is a control unit, residing on the tractor, that performs basic functions such as power handling, speed info, etc. The TECU data are displayed on this page.

Figure 3-38: TECU

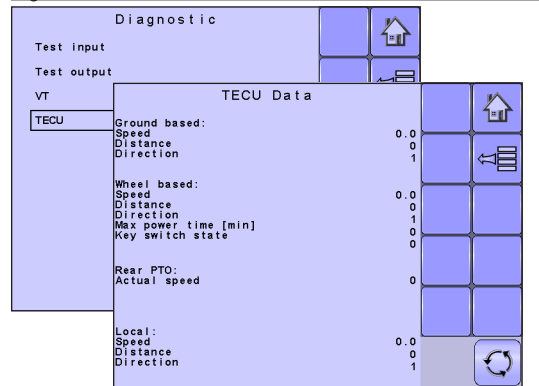

About

The About screen provides information on the IC18 such as software version, build number, etc. This information may become useful in case of technical support.

Figure 3-39: About

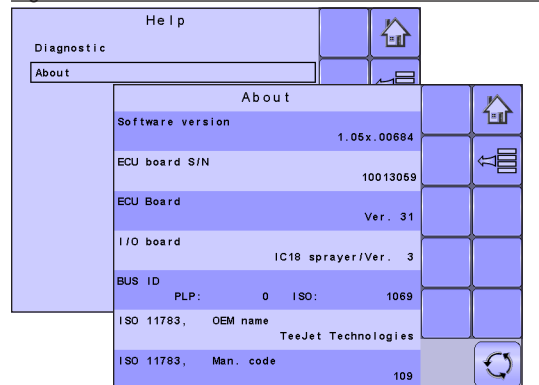

ISOBUS Job Computer : IC18 Sprayer

OVERVIEW

GETTING STARTED

SETUP

OPERATION

APPENDIX

CHAPTER 4 – OPERATION MODE



The Operation Screen accesses the working aspects of the IC18 including boom section control, rate control and trip/count/application information.

NOTE: Settings are automatically saved when selected.

NOTE: The menu structure on your display might vary from the one displayed in this User Manual depending on the virtual terminal being used.

AUTOMATIC OR MANUAL REGULATION MODE

Automatic regulation mode will automatically adjust the application rate based on the current speed in reference to the target rate. The target rate can be adjusted using the Boost/Step % Increase/Decrease Keys on the Operation Screen. Preset Application Rates define up to five (5) target rates for product being applied per hectare/acre. These can be toggled using the Toggle Preset Target Rate Key on the Operation Screen or Home Screen.

Manual regulation mode will retain an established regulation valve setting regardless of speed. The regulation valve setting can be adjusted using the Regulation Valve Open/Close Keys on the Operation Screen.

If a switchbox is being used to control the boom sections, automatic or manual regulation mode can be set on the Operation Screen.

When using the IC18, not a switchbox, for boom section control, automatic or manual regulation mode needs to be established on the Home Screen before entering Operation Mode.

1. On the Home Screen or Operation Screen , establish Automatic Operation Mode or Manual Operation Mode by pressing the AUTO/MANUAL KEY so that the green dot is on AUTO (automatic) or the hand (manual) accordingly.

Figure 4-1: Auto/Manual Key on Home Screen

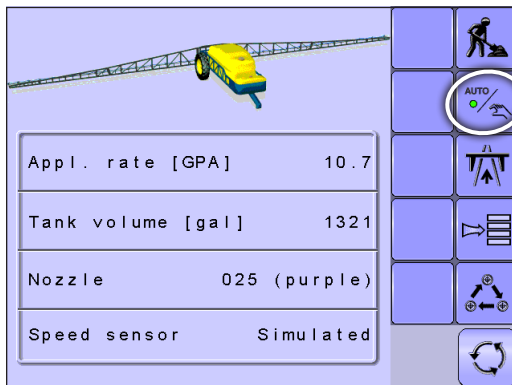

Auto/Manual Key on Operation Screen

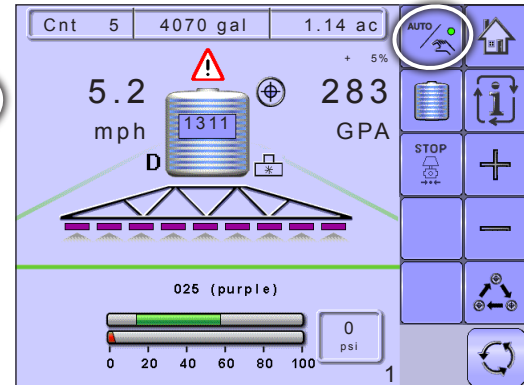

ISOBUS Job Computer : IC18 Sprayer

OPERATION MODE OVERVIEW

Information on the Operation screen will vary depending on the parameters set by the user and the OEM.

Figure 4-2: Operation Mode Screen Overview

OVERVIEW

GETTING STARTED







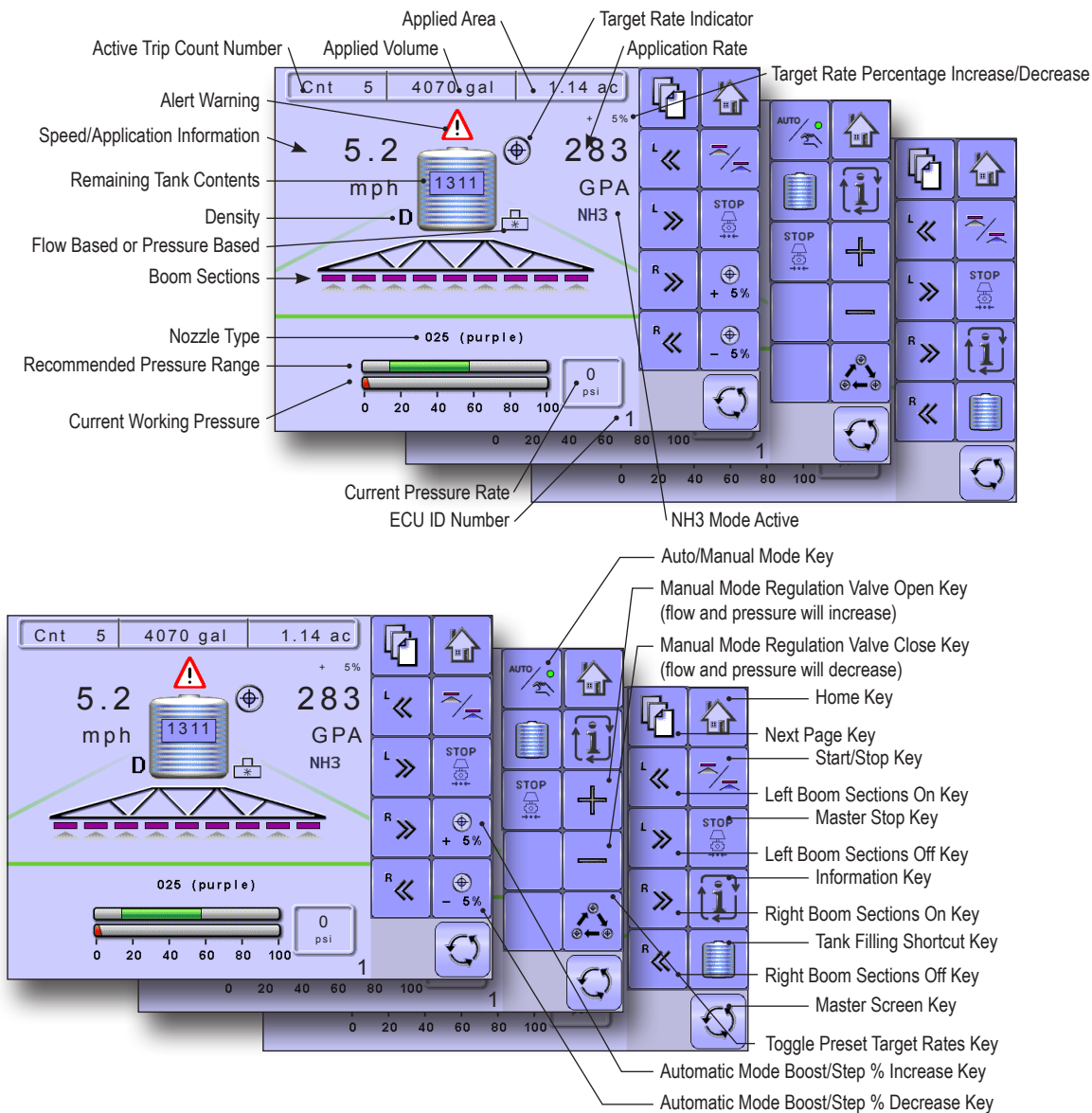







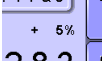

SETUP

OPERATION

APPENDIX

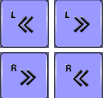









Keys Descriptions



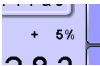





Icon	Description
	Home Key Press to return to the Home Screen
	Start/Stop Key Press to start or stop application
	Information Key Press to toggle between display modes
	Boost/Step Percentage Increase/Decrease Keys Press to establish the required boost percentage step, i.e. the step size, at which the application rate is to increase/decrease with the boost function 
	Manual Mode Regulation Valve Open Keys Press  to open the regulation valve Press  to close the regulation valve
	Toggle Preset Target Rates Key Press to toggle between established target application rates
	Auto/Manual Key Press to toggle between automatic and manual application modes. Automatic regulation mode will automatically adjust the application rate based on the current speed in reference to the target rate. Manual regulation mode will retain an established regulation valve setting regardless of speed.
	Tank Filling Shortcut Key Press for one-press access to the Tank Filling setup screen
	Master Stop Key Press to stop all application, close all regulation valves and change to manual regulation mode
	Next Page Key Press to toggle between soft key options
	Boom Sections On/Off Keys Press to turn on sections to left  , turn off sections from left  , turn on sections to right  or turn off sections from right 

ISOBUS Job Computer : IC18 Sprayer

Section and Icon Descriptions

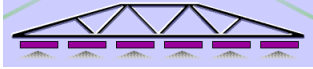
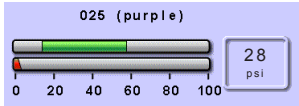
Section or Icon	Description
Job Information	This information bar displays the active count number, applied volume and applied area 
Count Number	Displays the current active trip or job number
Applied Volume	Displays volume applied for the selected count number
Applied Area	Displays applied area for the selected count number
Speed/Application Information	Displays vehicle speed or volume applied per minute or projected area per hour to be covered or projected total area remaining to be covered depending upon which view is active. The Information Key toggles  between display modes.
Remaining Tank Contents	Displays the remaining tank content <i>NOTE: If no tank sensor is fitted or the contents are not entered in the Tank Filling Menu prior to spraying, Tank Contents may not display the correct amount.</i> 
Application Rate	Displays the actual application rate per hectare/acre <i>NOTE: When the Master is "On" the actual application rate per hectare/acre will be displayed. When the Master is "Off" the target rate is displayed and the TARGET RATE ICON  appears</i>
Target Rate Percentage Increase/Decrease	Displays boost percentage step, i.e. the step size, at which the application rate is to increase/decrease with the boost function 
Alarm 	Displayed if an alarm condition is active
Flow Based or Pressure Based Icons	These symbols will only appear if both a flow sensor and a pressure sensor are installed.
	Flow Based - displayed if a regulation is based on flow
	Pressure Based - displayed if regulation is based on pressure.
Density 	Displays a "D" to the left of the tank icon if the density is set to "Fertilizer" instead of water.

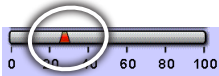
ISOBUS Job Computer : IC18 Sprayer

Section or Icon	Description
Boom Sections	<p>Displays the active  and inactive  boom sections as well as if they are on  (spray is blue) or off  (spray is gray).</p> <p><i>NOTE: The color on the boom sections indicates the color of the selected nozzle type.</i></p> 
Circulation sc cc	<p>If Circulation is installed and selected in the OEM Menu, “SC” (Semi Circulation) or “CC” (Full Circulation) will be displayed.</p>
NH3 Mode Active NH3	<p>Displays if the unit is in NH3 mode.</p>
Sprayer ID Number	<p>Displays the soft key number assigned to the displayed IC18 ECU.</p>
Nozzle Information	<p>This information section displays the nozzle type, recommended pressure range, current working pressure and high pressure limit.</p> 
Nozzle Type	<p>Displays the selected nozzle type</p> 
Recommended Pressure Range	<p>Displays the recommended pressure range for the selected nozzle (the green area indicates the pressure range). The pressure range will change depending upon the selected nozzle, working speed, etc.</p> <p>IMPORTANT! ALWAYS REFER TO THE RECOMMENDED PRESSURE RANGE AS FAILURE TO DO SO MAY RESULT IN UNEVEN SPRAY PATTERNS.</p> 
Current Working Pressure	<p>Displays the current working pressure</p> <p><i>NOTE: This pressure range should not exceed the recommended pressure range.</i></p> <p>IMPORTANT! ALWAYS REFER TO THE RECOMMENDED NOZZLE PRESSURE VALUES WHEN SETTING NOZZLE PRESSURE.</p> 
Current Pressure Rate	<p>Displays the current pressure to the nozzle</p> 

ISOBUS Job Computer : IC18 Sprayer

Master Screen



The Master Screen gives access to the systems currently available on your VT.

- To view the Master Screen options, select MASTER SCREEN KEY  in bottom right corner of any screen.

Figure 4-3: Master Screen



Master Screen Key on Operation Mode Screen

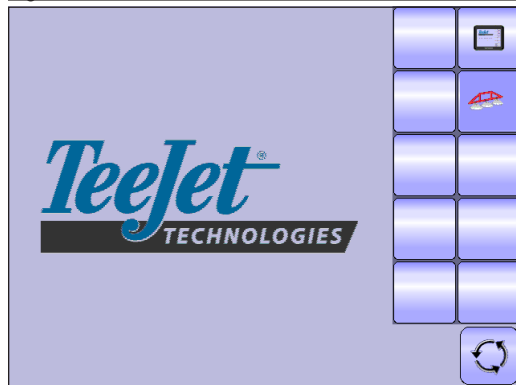
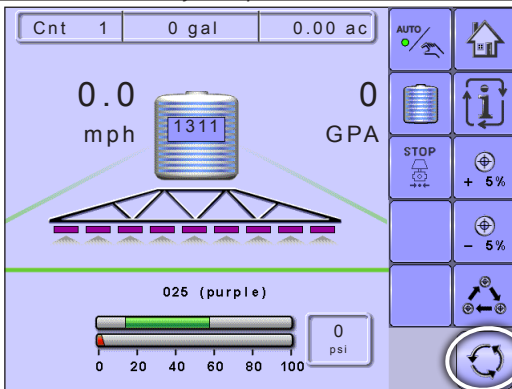

Home Screen



The Home Screen gives access to the IC18's available functions: Operation Mode, Transport Mode and Main Setup.

- To view the Home Screen, select HOME KEY  in the top right corner of any screen.

Figure 4-4: Home Screen

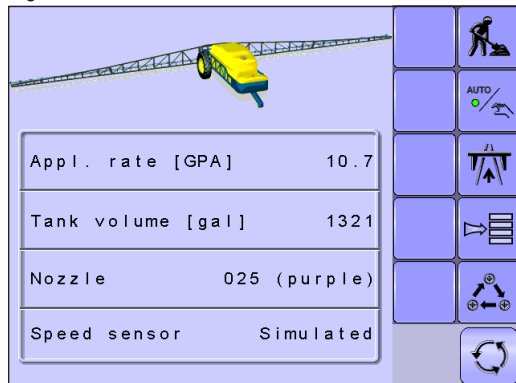

Home Key on Operation Mode Screen

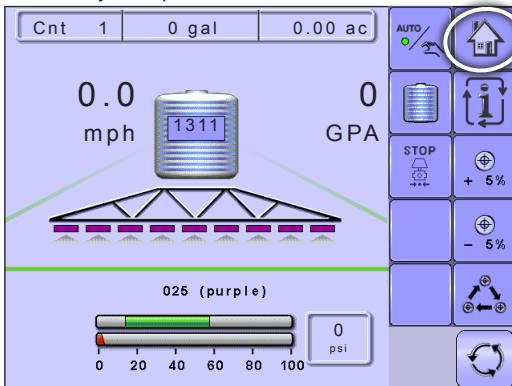

APPLICATION RATE OPTIONS

Target Rate Percentage Increase/Decrease

Target Rate Percentage Increase/Decrease Keys increase/decrease the application target rate per the established percentage set in the Machine Operation setup screen under Application Rate Step. Automatic regulation mode will automatically adjust the application rate based on the current speed in reference to the target rate. Preset Application Rates define up to five (5) target rates of product being applied per hectare/acre. These can be toggled using the Toggle Preset Target Rate Key  on the Operation Screen or Home Screen.





- To adjust the Target Rate, press the BOOST/STEP % INCREASE/DECREASE KEYS  .

Figure 4-5: Target Rate Percentage Increase/Decrease

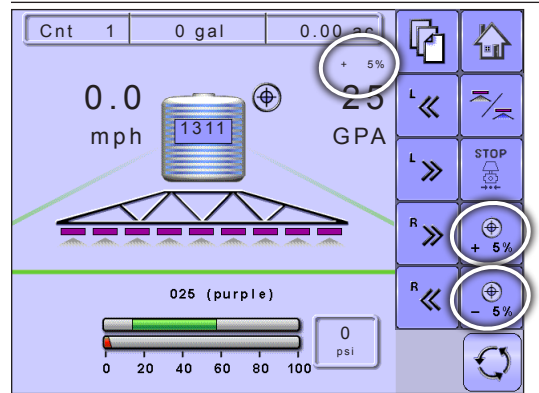

Regulation Valve Manual Open/Close

The regulation valve setting can be adjusted using the Regulation Valve Open/Close Keys   on the Operation Screen. Manual regulation mode will retain an established regulation valve setting regardless of speed.





- To adjust the regulation valve, press the REGULATION VALVE OPEN/CLOSE KEYS  .

Figure 4-6: Regulation Valve Manual Open/Close

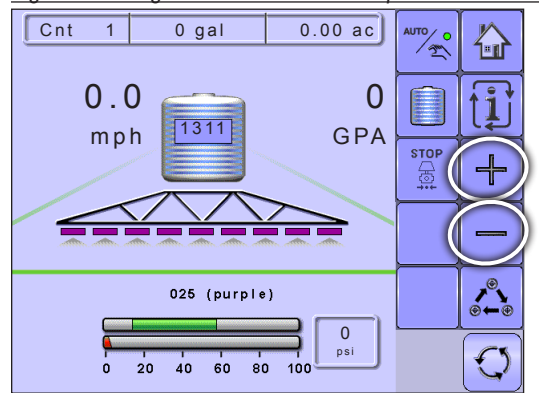

ISOBUS Job Computer : IC18 Sprayer

Target Rate

Preset Application Rates define up to five (5) target rates of product being applied per hectare/acre. These settings will set the same for all active trips. Target rates set to "0.0" will not be included in the toggle preset target rate options  on the Operation Screen or Home Screen.

If a switchbox is being used to control the boom sections, current target application rate can be set on the Operation Screen.

When a switchbox is not connected to the system current target application rate needs to be established on the Home Screen before entering Operation Mode.

With Switchbox

- To toggle between Target Application Rates, press the TOGGLE PRESET TARGET RATE KEY .

Figure 4-7: Target Application Rate

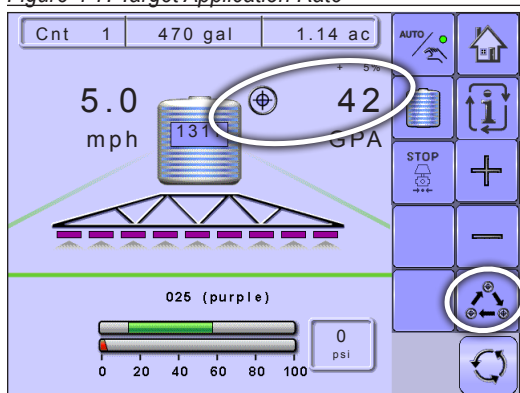

Without Switchbox

- To toggle between Target Application Rates, press the TOGGLE PRESET TARGET RATE KEY .

Figure 4-8: Target Application Rate

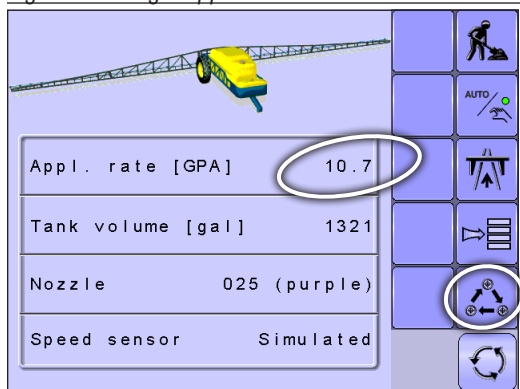

BOOM SECTIONS

Boom Sections displays the active  and inactive  boom sections as well as if they are on  (spray is blue) or off  (spray is gray).

The color on the boom sections indicates the color of the selected nozzle type.

Established Nozzle	
Size	Color
01	Orange
015	Green
02	Yellow
025	Purple
03	Blue
04	Red
05	Brown
06	Grey
08	White
10	Light Blue
15	Light Green
20	Black

Figure 4-9: Boom Sections

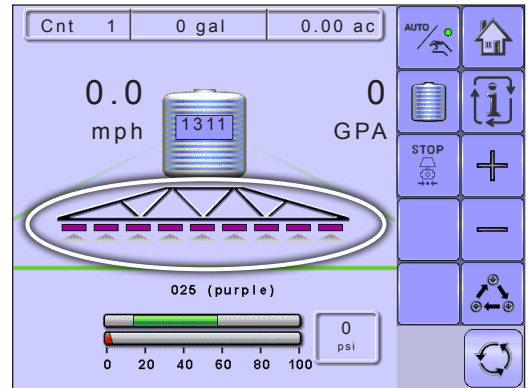

ISOBUS Job Computer : IC18 Sprayer

On/Off Sections from the Left or Right

When a switchbox is not connected for boom section control, booms sections are controlled using the Boom Sections On/Off Keys.

Without Switchbox

- To adjust the sections on the left, press the LEFT BOOM SECTIONS ON/OFF KEYS « « .
- To adjust the sections on the right, press the RIGHT BOOM SECTIONS ON/OFF KEYS » » .

With Switchbox

If a switchbox is being used to control the boom sections, boom sections will be controlled by the switchbox.

Figure 4-12: Operations Screen With Switchbox

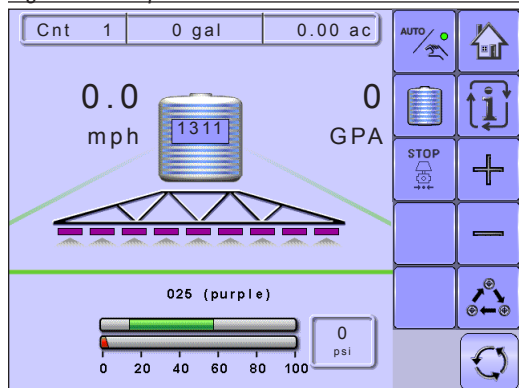

Figure 4-10: Left Off

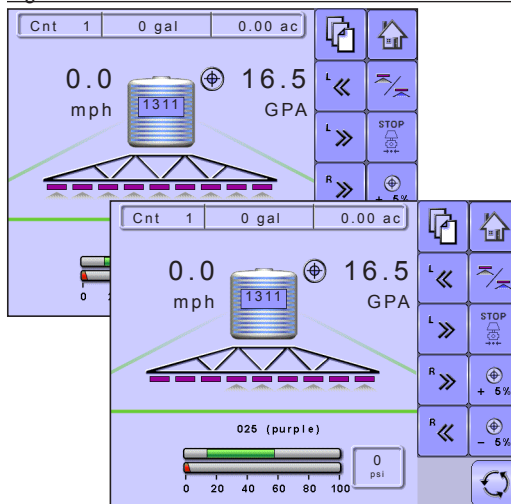
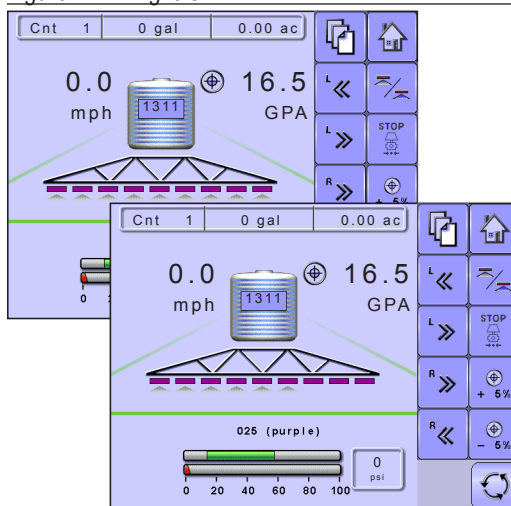

Figure 4-11: Right Off



Start/Stop Application

When a switchbox is not connected for boom section control, starting/stopping application is controlled using the Start/Stop Key.

Without Switchbox

- To start or stop the application, press the START/STOP KEY .

With Switchbox

If a switchbox is being used to control the boom sections, starting/stopping application will be controlled by the switchbox.

Figure 4-15: Operations Screen With Switchbox

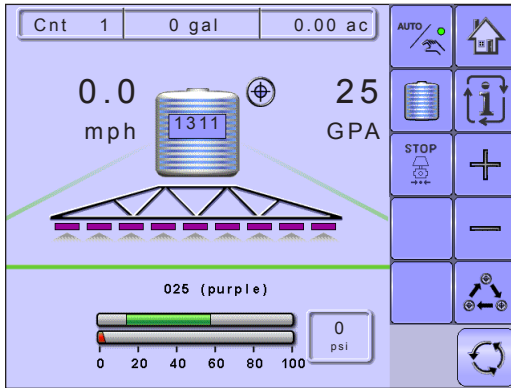

Figure 4-13: Spraying Stopped

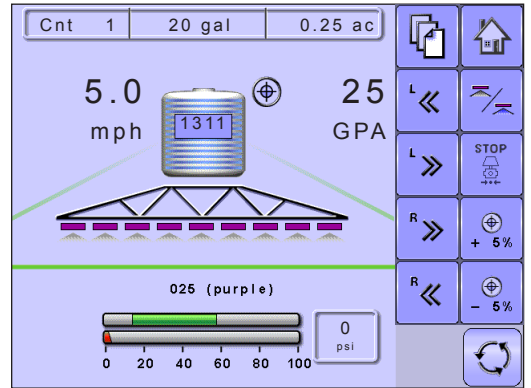
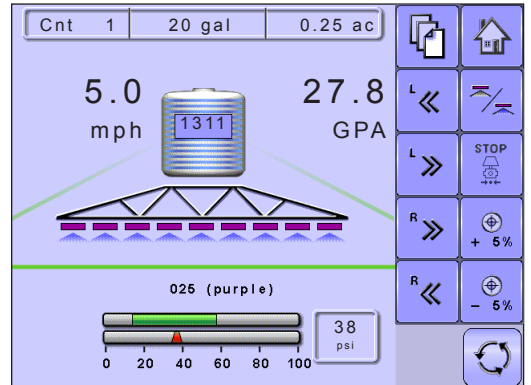



Figure 4-14: Spraying Started



ISOBUS Job Computer : IC18 Sprayer

Master Stop Key

Master Stop Key is used to stop all application, close all regulation valves and change to manual regulation mode.

- To stop all application, close all regulation valves and change to manual regulation mode, press the STOP KEY .

This is designed to be like an emergency stop button.

With Switchbox

If a switchbox is being used to control the boom sections, the Master Stop Key will override the Master Switch on the switchbox and turn off any boom application in progress.

Figure 4-16: Spraying In Progress

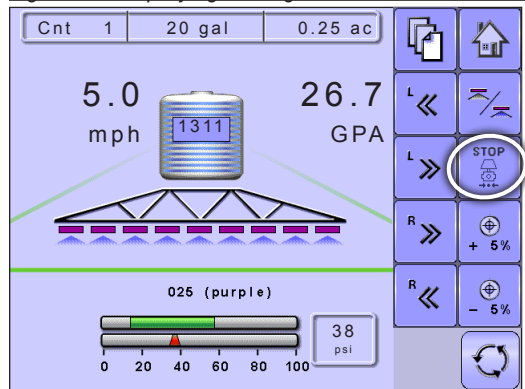
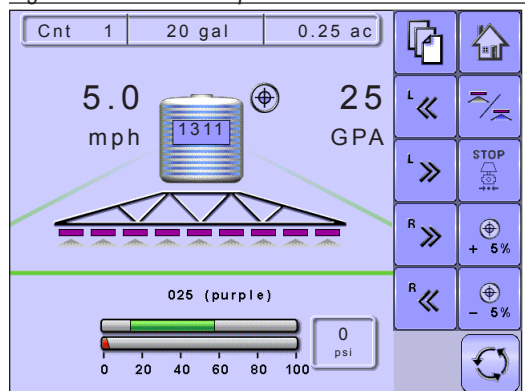

Figure 4-17: Master Stop Pressed



INFORMATION KEY

Information Key toggles the Speed/Application Information section on the Operation Screen between the display modes.

- Vehicle speed
- Volume applied per minute
- Projected area per hour to be covered based on current speed, target rate and tank level
- Projected total area remaining to be covered based on current target rate and current tank level

Figure 4-18: Information Key

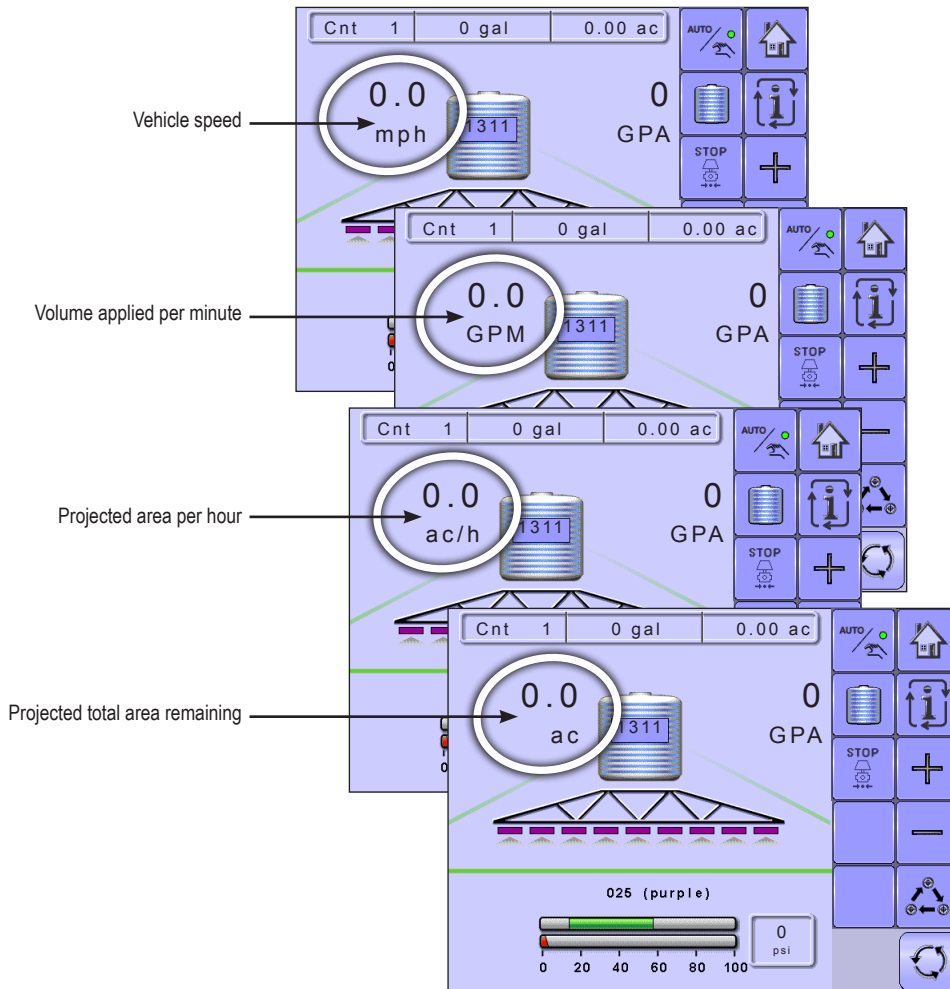

ISOBUS Job Computer : IC18 Sprayer

TRANSPORT MODE

While in Transport Mode, all operation functions are locked off and cannot be activated. Transport Mode displays the speed in analogue mode.

Figure 4-19: Transport Mode

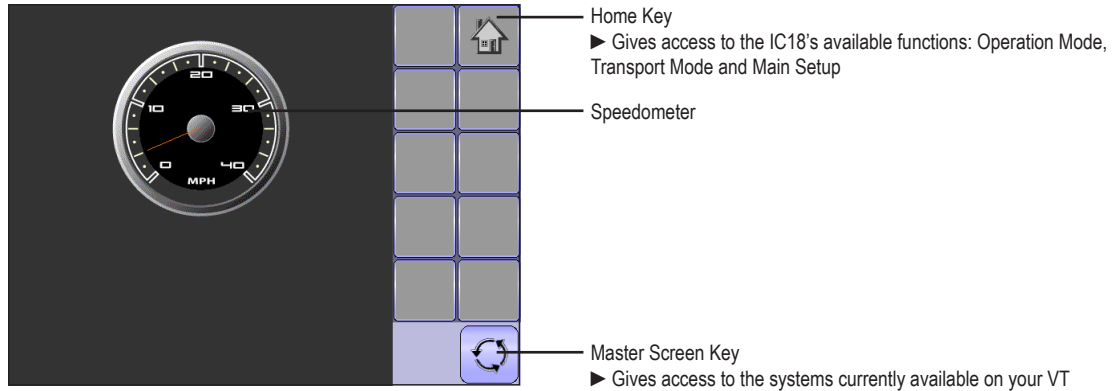

OVERVIEW

GETTING STARTED

SETUP

OPERATION

APPENDIX

APPENDIX A - FACTORY SETTINGS & RANGES

JOB PARAMETERS

Description	Factory Setting	Range	User Setting
Active Trip Counter	1	1 - 10	1
			2
			3
			4
			5
			6
			7
			8
			9
			10
Preset Application Rate #1	0.0 GPA (US)	0.0 - 700.6 (US)	#1
Preset Application Rate #2	0.0 l/ha	0.0 - 6553	#2
Preset Application Rate #3	0.0 GPA (UK)	0.0 - 583.4 (UK)	#3
Preset Application Rate #4			#4
Preset Application Rate #5			#5
Nozzle		Established under Machine--> Implement Parameters--> Nozzle Preset Setup	

ISOBUS Job Computer : IC18 Sprayer

MACHINE

Tank Filling

Description	Factory Setting	Range/Options	User Setting
Actual Content	0 lbN (US) 0 kgN 0 lbN (UK)	0 - 12000 0 - 5443 0 - 12000	
Density	Water	Water Fertilizer	
Density Factor	6.68 Lb/Gal (US) 0.80 kg/l 8.02 Lb/Gal (UK)	6.68 - 16.69 (US) 0.80 - 2.00 8.02 - 20.04 (UK)	

Operation

Description	Factory Setting	Range/Options	User Setting
Application Rate Step	5%	1 - 20	
Speed Source	CAN	CAN Implement Simulated	
Simulated Speed	0.0 mile/h / km/h	0.0 - 99.9	

Implement Parameters

Regulation Parameters

Description	Factory Setting	Range	User Setting
Valve Calibration, Rough	19	1 - 19	
Valve Calibration, Fine	9	1 - 9	
Nozzle Spacing	19.7 in 50 cm	1.0 - 787.4 1.0 - 1999.9	
Regulation Mode	Flow Based	Pressure Based Flow Based	

OVERVIEW

GETTING STARTED

SETUP

OPERATION

APPENDIX

Section Width

Description	Factory Setting	Range	User Setting
Section Width	118 in. / 300 cm	1 - 9999	

Nozzle Preset Setup

Description	Factory Setting	Range/Options	User Setting
Nozzle Preset	1	1 - 5	
Nozzle Type	General	General User Tip	
Nozzle Size	025 (purple)	01 Orange 015 Green 02 Yellow 025 Purple 03 Blue 04 Red 05 Brown 06 Grey 08 White 10 Light Blue 15 Light Green 20 Black	
Low Pressure Limit	14 psi 1.0 bar	0 - 369 0.0 - 25.5	
High Pressure Limit	58 psi 4.0 bar	0 - 369 0.0 - 25.5	
Reference Flow	0.25 GPM (US) 0.81 l/min 0.18 GPM (UK)	0.00 - 26.42 (US) 0.00 - 999.99 0.00 - 22.00 (UK)	
Reference Pressure	40 psi (US) 2.00 bar 29 psi (UK)	1 - 1450 (US) 0.10 - 99.99 1 - 1450 (UK)	

ISOBUS Job Computer : IC18 Sprayer

Calibrations

Implement Speed Sensor

Description	Factory Setting	Range/Options	User Setting
Pulses per Distance	0	0 - 33445	

Alarm Configurations

Description	Factory Setting	Range/Options	User Setting
CAN Speed Source Timeout	4 sec	0 - 999	
Active Trip Count Imformtaion	Off	Off On	
Tank Content Minimum	0 GAL (US) 0 liters 0 GAL (UK)	0 - 2641 (US) 0 - 9999 0 - 2199 (UK)	

USER INTERFACE

Description	Factory Setting	Range/Options	User Setting
Use Perferred VT	Off	Off On	
Pair with Switchbox	Auto	Auto None <<specific ID #>>	
Pair with BoomPilot ECU	Auto	Auto None <<specific ID #>>	
Show Number on Soft Key	No	No Yes	
Sprayer Number (FI)	1	1 - 9	

OVERVIEW

GETTING STARTED

SETUP

OPERATION

APPENDIX

APPENDIX B - UNIT SPECIFICATIONS

Dimensions		7.5 x 7.25 x 2.375 in 19.05 x 18.42 x 6.03 cm
Weight		1.42 lbs / 0.644kg
Connector		30 position Cinch pins. A1-K3 30 position Cinch pins. L1-Y3
Environmental	Operating	-40 to +85°C
	Humidity	90% non-condensing
Input/Output		ISO 11783 (ISOBUS)
Power Requirement		<9 watts @12 VDC

IC18 SPRAYER JOB COMPUTER USER MANUAL

Software Version 1.06



1801 Business Park Drive
Springfield, Illinois 62703 USA
Tel: (217) 747-0235 • Fax: (217) 753-8426
www.teejet.com

A Subsidiary of  *Spraying Systems Co.*

98-05204 R1 US
© TeeJet Technologies 2012