

## Legacy 2000 System



## USER GUIDE

---

PN: 98-05034



## MID-TECH WARRANTY

**MIDWEST TECHNOLOGIES ILLINOIS, LLC** (herein called Mid-Tech) warrants to the original purchaser that the product purchased shall be free of defect in material or workmanship. If the product proves to be defective within the warranty period the purchaser must return, freight prepaid, said product to Mid-Tech within thirty (30) days after such defect is discovered. Upon inspection and examination by Mid-Tech, and at its option, Mid-Tech shall repair or replace, with a new or comparable product. No product will be considered defective if it substantially fulfills the performance specifications. Purchaser shall be responsible for all required maintenance service in accordance with procedures outlined in Mid-Tech's product operator manual or service bulletins.

All product(s) replaced or repaired under warranty shall carry the remainder of the warranty left on the original purchase. All out of warranty product(s) serviced for fee or goodwill will have ninety (90) days of warranty. The ninety (90) days shall begin on the date serviced by Mid-Tech.

Warranty periods for Mid-Tech products shall be:

Mid-Tech Legacy Consoles	-	2 ½ years
Mid-Tech TASC Consoles	-	2 ½ years
Mid-Tech ARC Consoles	-	2 ½ years
Mid-Tech AgLogix Consoles	-	2 ½ years
<b>Mid-Tech Switch boxes</b>	-	<b>2 ½ years (3, 5, 9 boom)</b>
All other Mid-Tech products	-	12 months (unless otherwise noted)

### WARRANTY LIMITATIONS AND EXCLUSIONS

Mid-Tech will have no warranty obligation hereunder if the product is subjected to abuse, misuse, improper or abnormal usage, acts of God, faulty installation, improper maintenance as outlined in Mid-Tech's product operator manual or service bulletins. Consumable items (items that are used during normal operation) such as light bulbs, batteries, etc., and expendable items (items which wear out in normal use) such as injection pump tubes, flow meter bearings, etc., will not be covered by warranty. For products that come in direct contact with chemical, the specific recommendations contained in Mid-Tech product bulletins must be adhered to, or this warranty is void. Any repairs or alterations, other than those provided by Mid-Tech and/or its authorized representatives, will void the warranty. Mid-Tech neither assumes nor authorizes anyone to assume for it any other obligation or liability in connection with said product.

### **DISCLAIMER OF UNSTATED WARRANTY**

The warranty printed above is the only warranty applicable to this purchase. Mid-Tech's warranty cannot be modified by any person or entity, including without limitation, any distributor or retailer of Mid-Tech. All other warranties, express or implied, including but not limited to, the implied warranties of merchantability and fitness for a particular purpose, are disclaimed.

### **LIMITATION OF LIABILITY**

It is understood and agreed that Mid-Tech's liability, whether in contract, in tort, under any warranty, in negligence or otherwise, shall not exceed the return of the amount of the purchase price paid by purchaser and under no circumstances shall Mid-Tech be liable for special, indirect or consequential damages. In particular, Mid-Tech shall not be liable for damage to crops as the result of misuse or negligence in the application of chemicals or operation of Mid-Tech products. The price stated for the equipment is a consideration in limiting Mid-Tech's liability. No action, regardless of form, arising out of the transactions under this agreement may be brought by purchaser more than one year after the cause of action has occurred.

# Table of Contents

 A black rectangular graphic with the word "Introduction" written in white, slanted text from the bottom-left to the top-right.

<b>Chapter 1 Introduction</b>	<b>1-1</b>
<b>Chapter 2 Start-up</b>	<b>2-1</b>
START-UP SEQUENCE	2-1
<b>Chapter 3 Operate</b>	<b>3-1</b>
ENTERING THE OPERATE MODE	3-1
PRODUCT MONITORING	3-1
PRODUCT CONTROL	3-2
CHOOSING PRE-SELECTED RATES	3-2
MANUAL RATE CONTROL	3-2
RESETTING ACCUMULATORS	3-3
SPEED AND DISTANCE MONITORING	3-4
TOTAL DISTANCE RESET	3-4
MANUAL SPEED	3-4
AREA MONITORING	3-5
AREA RESET FUNCTION	3-6
DATA LOGGING	3-7
<b>Chapter 4 Setup</b>	<b>4-1</b>
FIELD SETUP	4-1
LIQUID MODE SETUP	4-2
PRESET APPLICATION RATES	4-2
FLOWMETER CAL. # SET	4-3
PRESSURE BASED SETUP	4-3
GRANULAR/NH3 SETUP	4-6
PRESET APPLICATION RATES	4-6
GRANULAR CAL. # SET	4-7
INITIAL SPREADER CONSTANT	4-7
SEEDER SETUP	4-8
PRESET APPLICATION RATES	4-8
SEEDER CAL # SET	4-9
SPINNER MODE SETUP	4-10
PRESET SPINNER RATES	4-10
SPINNER CAL # SET	4-11
INJECTION PRIME/CALIBRATE FUNCTION	4-11
PRIME FUNCTION	4-12
CALIBRATE FUNCTION	4-13
MACHINE SETUP	4-14
PRODUCT MODES	4-14
APPLICATION UNITS OF MEASURE	4-15
VALVE/DRIVE TYPES	4-16
SERVO VALVE SETUP	4-16
PWM VALVE SETUP	4-20
INJECTION DRIVE SETUP	4-21
SYSTEM SETUP	4-22
SYSTEM UNITS	4-22
KEY BEEP	4-23

SHOW MODULES -----	4-23
LOG DATA -----	4-24
COM PORTS -----	4-25
HARDWARE TEST -----	4-26
SOFTWARE RESET -----	4-26
TIME AND DATE -----	4-27
SPEED SETUP -----	4-28
SPEED CALIBRATION -----	4-28
GSO SETUP -----	4-29
BOOM SETUP -----	4-29
SWATH SETUP -----	4-30
NUMBER OF SWATHS -----	4-30
BOOM ASSIGNMENT -----	4-30
GPS SPEED SETUP -----	4-31
<b>Chapter 5 Trouble Shooting -----</b>	<b>5-1</b>
<b>Chapter 6 Emergency Operations ----</b>	<b>6-1</b>
GROUND SPEED SENSOR FAILURE -----	6-1
FLOW CONTROL VALVE FAILURE -----	6-2
FLOWMETER/PRESSURE SENSOR FAILURE -----	6-3
APPLICATION RATE SENSOR FAILURE -----	6-4
<b>Appendix A System Diagram -----</b>	<b>A-1</b>
SAMPLE SYSTEM DIAGRAM -----	A-2
<b>Appendix B - System Overview -----</b>	<b>B-1</b>
<b>System Components -----</b>	<b>B-2</b>
MODULES -----	B-2
CABLES AND HARNESSSES -----	B-4
LEGACY 2000 CONSOLE -----	B-4
POWER SPEED MODULE -----	B-4
SWITCH SENSE MODULE -----	B-5
PRODUCT CONTROL MODULE -----	B-5
CAN EXTENSION CABLES -----	B-6
<b>Appendix C - Glossary/Tables -----</b>	<b>C-1</b>
GLOSSARY -----	C-2
ENGLISH/METRIC CONVERSION -----	C-8
USEFUL FORMULAS -----	C-9
MISCELLANEOUS NOTES -----	C-10
CALIBRATION NUMBERS -----	C-10
NH3 DENSITY TABLE -----	C-10
<b>Index -----</b>	<b>I-1</b>

---

Mid-Tech, Auto-Range, & TASC are all registered trademarks of Midwest Technologies, Inc.

## Chapter 1 Introduction

Welcome to the Legacy 2000, the new generation of chemical control systems. The Legacy 2000 controls up to two different products, automatically, manually, or under external control.

New technology allows the Legacy 2000 console to communicate with remotely mounted control modules through a single cable. These modules in turn control and monitor the valves, sensors, pumps, etc. of the system. Control modules can be "tapped" into the main cable at any point, which means that they can be mounted anywhere on the machine, near the components that they are associated with. Using one cable to connect the modules to the control console in the cab eliminates the "rat's nest" of cables running into the cab from all over the vehicle.

The operating program is contained on an SRAM card inserted into the side of the console making it easy to change or upgrade your program. **(CAUTION: To prevent damage to the program or the SRAM Card, the console must be powered down while inserting or removing the card)**

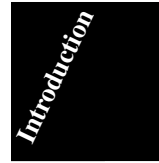

### HOW TO USE THIS MANUAL

This User Guide provides you with the basic information needed to set up and operate the MID-TECH® Legacy 2000 control system. Actual procedures may vary, depending on the configuration of your system.

When you see "Mitch", he is pointing out special information that you should be aware of, regarding safety, preventing equipment damage, an easier way to perform an operation, etc..



A brief description of the console control buttons and the icons that appear on the display are described at the edges of the pages in Chapter 3 (Operate functions) and Chapter 4 (Setup Functions)

The topics are presented with the most often used information located toward the front of the guide.

Following is a listing of the chapters in this manual, along with a brief description of the information found in each chapter.

**Chapter 1** - “Introduction” - A brief overview of the User Guide.

**Chapter 2** - “Start-up” - Describes the system start-up sequence followed when powered on.

**Chapter 3** - “Operation” - Describes how to control the application process.

**Chapter 4** - “Setup” - Takes you through the calibration of each sensor providing input to the system and the entering of other necessary information.

**Chapter 5** - “Trouble Shooting” - Lists possible causes and remedies for the error messages that may appear on the display.

**Chapter 6** - “Emergency Operation” - Suggests ways to operate, **under reduced accuracy**, in the event of a major fault.

**Appendix A** - “Sample System Diagram.”

**Appendix B** - “System Components” - Describes the major components of the Legacy 2000 system and their individual functions.

**Appendix C** - Glossary/Tables

**Back Cover** - Quick Start/Quick Set Up Guides

## Chapter 2 Start-up

### START-UP SEQUENCE

The Legacy system monitors the accessory position of the ignition switch. When the ignition switch is turned on the Legacy system begins its start-up sequence. The console will alternate between the two screens shown in Fig. 2-1 while it is performing its system check.



Fig. 2-1. Legacy System Check Screens





During the system check each module (Console, PSM, SSM, PCM) is verified to make sure nothing has changed since the system was last powered up. If any discrepancies are found the console asks for user input to verify the module information.

Once the system check is complete the screens shown in Fig. 2- 2 appear and three beeps are heard.



Fig. 2-2. System Ready Screens

At this point the operator can:

- Press the Setup button (  ) to make any necessary system setup changes to the Legacy system
- Press the Operate button (  ) to go directly to the operate mode.

This page left blank intentionally



**Chapter 3 Operate**

This chapter discusses the various “Operate” screens that allow the operator to monitor and control the application process.

**ENTERING THE OPERATE MODE**

Press **Operate** to enter the “Operate” mode. The screen shown in Fig. 3-1 appears. There are several icons that may appear on the screen to provide information to the operator. These icons are explained in the corner of the even numbered pages.

- Operate**
- Setup**
- Manual**
- Left**
- Right**
- Enter**
- 1 Product 1**
- 2 Product 2**
- Speed**
- Area**
- Increase**
- Decrease**

**PRODUCT MONITORING**

Figures 3-1 through 3-4 give examples of the types of information provided by some of the different screens. The screen shown in Fig. 3-1

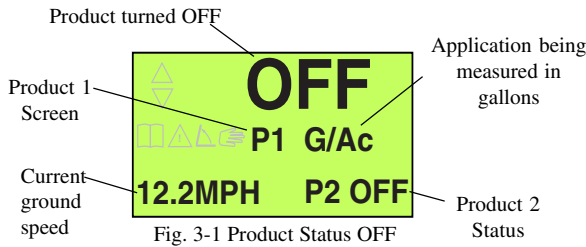
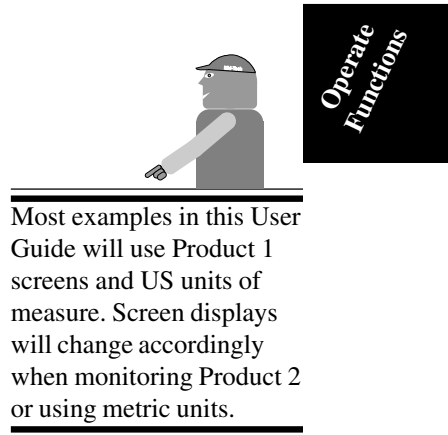

Fig. 3-1 Product Status OFF



Most examples in this User Guide will use Product 1 screens and US units of measure. Screen displays will change accordingly when monitoring Product 2 or using metric units.

is the “Product Status OFF” screen, the first of several “Product Information” screens. Pressing **Enter** turns the product ON, changing the **1** from red to green indicating that the product is turned ON, and taking you to the “Product Status ON” screen (Fig. 3-2).

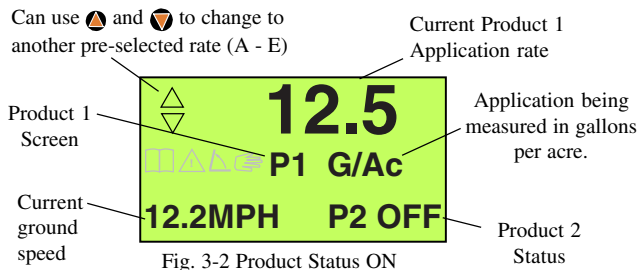









Fig. 3-2 Product Status ON

Pressing **1** at this point causes the display to alternate between Fig. 3-2 (Product ON) and Fig. 3-3 (Total

-  Logging On
-  System Error
-  Not Used
-  Manual Mode
-  Control Active
-  Use Enter Key
-  Use Inc/Dec
-  Use Left/Right

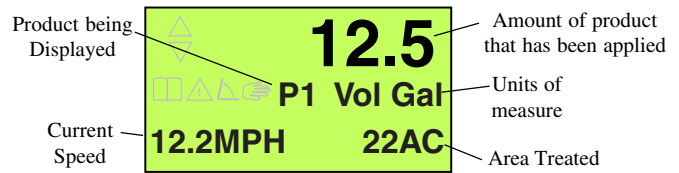



Fig. 3-3 - Total Applied

Applied).

While in the “Product OFF” and “Product ON” screens (Figs. 3-1 & 3-2) the  and  buttons can be used to select the information to be displayed on the third line of the display, as shown in Fig. 3-4.

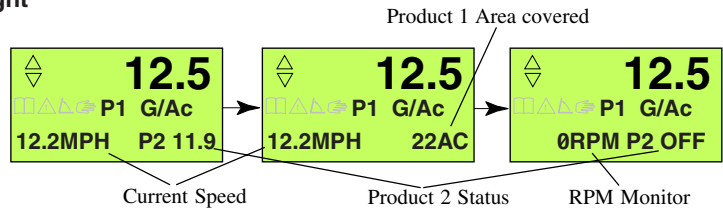





Fig. 3-4 - Third Line Display

Pressing  gives the operator the same set of screens, displaying information about product 2, with Product 1 being monitored in the background.

## PRODUCT CONTROL

### CHOOSING PRE-SELECTED RATES

While in the “Product Off” or “Product ON” screens (Figs. 3-1 & 3-2) the  and  buttons can be used to step through the application rates (A - E) preset in the “Field Setup” routine. When the desired rate is being displayed, wait for about 3 seconds. The selected rate will be locked in and the display will revert back to the previous screen. The selected rate is now the control rate.

### MANUAL RATE CONTROL

The application rate of each product can be controlled manually, using the “Manual Mode”, from either the “Product ON” or “Product OFF” screens. To enter “Manual Mode” select the desired product and press . The screen shown in Fig. 3-5 is displayed and the associated control valve “holds” in its present position (closed if product is turned OFF or

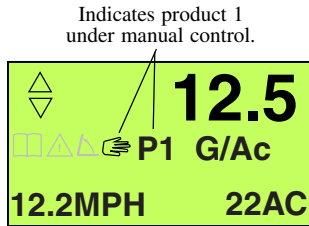

Fig. 3-5 Manual Mode

at the current rate if the product is turned on) and can only be changed using the ▲ and ▼ buttons, overriding any programmed rate or external variable rate command. When “Manual Mode” is turned off, control of the application rate returns to the previous input source.

Each product works independently meaning one or both products can be under manual control but only the selected product will be affected by the ▲ and ▼ buttons at any one time.

To return to automatic control select the desired product (1 or 2) and press [Manual] again. The “Manual Mode” symbol on the display is turned off indicating that the product is back under automatic control.

### RESETTING ACCUMULATORS

The “Total Applied” accumulators for each product can be reset independently, with the product turned ON or OFF. Just display the “Total Applied” screen (Fig. 3-3) for the desired product and press ▼. The confirmation message shown in Fig. 3-6 appears in the third line of the display.

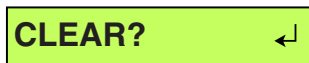

Fig. 3-6 Clear Alert

Press [Enter] to reset the accumulator to zero.

- Operate
- ⓘ Setup
- ☰ Manual
- ◀ Left
- ▶ Right
- ↵ Enter
- 1 Product 1
- 2 Product 2
- 🚗 Speed
- 📏 Area
- ▲ Increase
- ▼ Decrease



**CAUTION: EXTREME CARE MUST BE USED WHEN OPERATING IN “MANUAL MODE”.** The longer the ▲ and ▼ buttons are held down the faster the rate at which the valve moves. This means that the application rate can change drastically in a short amount of time causing a severe over or under application.

- ☐ Logging On
- ⚠ System Error
- △ Not Used
- ☞ Manual Mode
- ⬆ Control Active
- ↵ Use Enter Key
- ▲ Use Inc/Dec
- ▶ Use Left/Right

### SPEED AND DISTANCE MONITORING

While in the “Operate Mode” pressing  accesses the “Speed/Distance” function. The screens used in this function are shown in Fig. 3-7. The first screen that appears is screen “A” which

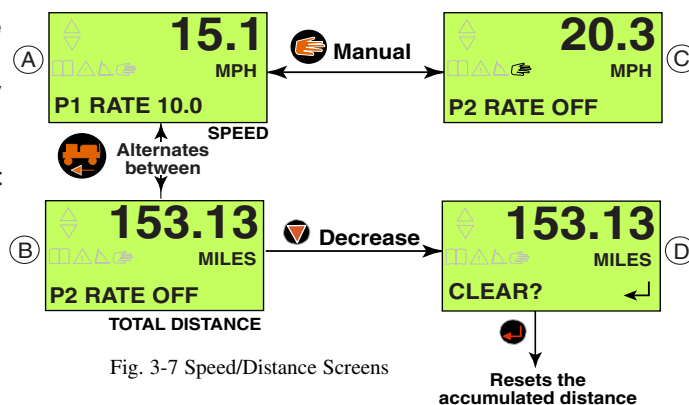





Fig. 3-7 Speed/Distance Screens





indicates the current vehicle speed with “Product 1 and 2” status alternating in the lower left corner. Pressing  now alternates the display between screen “A” and screen “B” which indicates the total distance traveled. To exit the “Speed/Distance” function press any other function button.

#### TOTAL DISTANCE RESET

To reset the Total Distance accumulator go to screen “B” of Fig. 3-7 and press . This takes you to screen “D” with the alert at the bottom of the display. To reset the accumulator press . To exit the “Total Distance Reset” function without resetting the accumulator press any other function button.

#### MANUAL SPEED

The Legacy 2000 has a “Manual Speed” function that allows the operator to manually input a simulated speed which overrides the actual vehicle ground speed. This feature can be used to perform static tests on the system or in an emergency situation such as the failure of the vehicle speed sensor.

To switch to Manual Speed press  from Screen “A” in Fig. 3-7 taking you to screen “C” which is similar except for the  symbol indicating that you are operating under Manual Speed control. While in screen “C” the operator can use the  and  buttons to adjust the speed being simulated by the system. Pressing  again turns the “Manual Speed” function off and the speed control reverts to the previous input source.

The Manual Speed selected is held in the console, even when the feature is turned off, until the console is powered OFF. The Manual Speed value then defaults back to 5.0 MPH.

-  Operate
-  Setup
-  Manual
-  Left
-  Right
-  Enter
-  Product 1
-  Product 2
-  Speed
-  Area
-  Increase
-  Decrease

**AREA MONITORING**

To monitor the Total Area Accumulation of the individual products and swaths press  which presents the screen shown in Fig. 3-8. Continu-

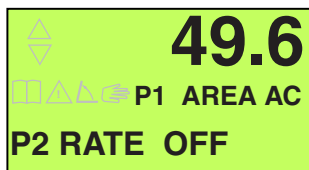

Fig. 3-8 Area Display



ing to press and release  cycles the display through the following screens:

- The total accumulated area for each active product
- The total accumulated area for each active Swath
- The swath width for each active swath

As each screen is being displayed the third line of the screen continuously cycles through:

- P1 RATE
- P2 RATE
- Current Vehicle Speed

Press any other function to exit the “Area Display” screen.

-  Logging On
-  System Error
-  Not Used
-  Manual Mode
-  Control Active
-  Use Enter Key
-  Use Inc/Dec
-  Use Left/Right



**CAUTION:** When performing a “Reset All” on the Area accumulators, even the accumulators for active products will be reset.

**AREA RESET FUNCTION**

Each area accumulator can be reset individually or all can be reset at the same time. When resetting a **Product Area** accumulator the product must be turned OFF. Select the screen displaying the accumulator (Product or Swath) that you want to reset. Press  to take you to the screen shown in Fig. 3-9. (The information displayed on the center

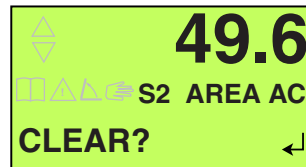



Fig. 3-9 - Area Reset Screen

line will vary depending on which accumulator you have selected.) To reset the selected accumulator press . To exit without resetting press any other function button.

To reset all area accumulators at the same time press  from the screen in Fig. 3-9 taking you to the screen

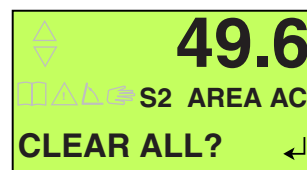



Fig. 3-10 Area clear all Screen

in Fig. 3-10. Press  to reset all area accumulators. To exit without resetting press any other function button.

**DATA LOGGING**

The Legacy 2000 can log operational data to either an external recording device, connected to the COM 1 or COM 2 ports, or to the SRAM Card (**See caution at side**) in the Legacy console. To do this the Logging Function must first be configured as described in Chapter 4 under “Log Data”.

To initiate Data Logging hold the  button down for three seconds. The Logging Control Screen shown in



Fig. 3-11 - Starting Logging

Fig. 3-11 will appear. Press  to start the logging process. Pressing any other button will take you out of the Logging Control Screen without making any changes.

With logging active the logging icon () will appear on all screens.

The same procedure is used to stop logging except the



Fig. 3-12 Stopping Logging

screen will look like the one in Fig. 3-12. When  is pressed logging stops and the logging icon disappears from the screen.

-  Operate
-  Setup
-  Manual
-  Left
-  Right
-  Enter
-  Product 1
-  Product 2
-  Speed
-  Area
-  Increase
-  Decrease



**CAUTION:** Always make sure the Legacy console is powered down before inserting or removing the SRAM card.

This page left blank intentionally



## Chapter 4 Setup

Before the Legacy system is used for chemical application, important information must be entered using the buttons on the face of the console. The icons for these control buttons, and their functions, are shown to the right.

**NOTE:** Always read and follow the prompts and messages on the screen carefully. The first line indicates the value currently being adjusted. The second line indicates the function being set up, instructions, or other information. The third line provides information and instructions. The display may cycle through several screens to provide all needed information. See Fig. 4-1 for examples.

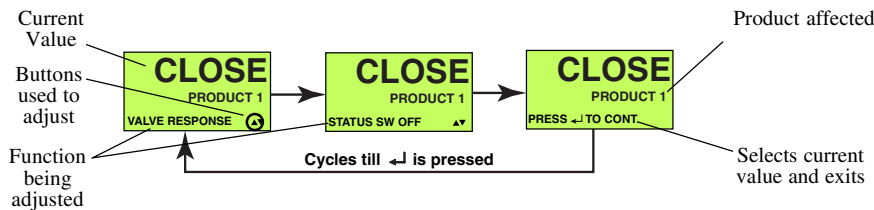
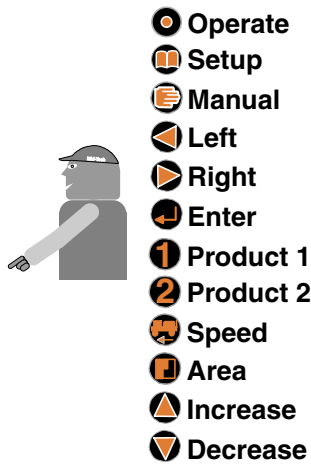



Fig. 4-1: Screen Cycling



To enter the Setup mode press , taking you to the “Main Setup” screen (fig. 4-2).

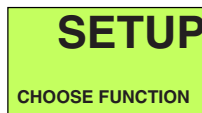





Fig. 4-2: Main Setup Screen

### FIELD SETUP

The “Field Setup” functions allow you to adjust values such as application rates, density, calibration numbers, etc.. The “Field Setup” mode is entered by pressing the desired product button,  or , from the Main Setup Screen (Fig. 4-2).

The “Product Application Modes” can be divided into 5 basic groups:

-  Logging On
-  System Error
-  Not Used
-  Manual Mode
-  Control Active
-  Use Enter Key
-  Use Inc/Dec
-  Use Left/Right

- Liquid Mode (Page 4-2)
- Granular/NH<sub>3</sub> Mode (Page 4-6)
- Seeder Mode (Page 4-8)
- Spinner Mode (Page 4-10)
- Injection Mode (Page 4-11)

## LIQUID MODE SETUP

### Preset Application Rates

As many as five different rates (A - E) can be preset into the Legacy 2000 Console.

With the desired “Product Application Mode” selected under “Machine Setup” (Pg. 4-14) press **1** or **2** from the “Main Setup” screen (Fig. 4-2) to enter the appropriate setup function. (We are using “Liquid Product 1” for this illustration.) This displays the screens shown in Fig. 4-3. Which indicates that you are



Fig. 4-3 Setting preset Rates

setting Preset Rate “A”, it is being measured in Gallons per Acre and the current value is 10.0 GPA. The **▶◀** symbol indicates that you can use the **◀** and **▶** buttons to select which digit of the Rate Value is changed (The flashing digit). The **▲▼** symbol indicates that you can use the **▲** and **▼** buttons to adjust the value of the flashing digit. When the desired value has been selected press the **ENTER** button to register the value and advance to the Rate “B” preset screen. This continues until all desired Preset Rates are set.

When setting the “Preset Rates” the **⇄** button can be used to move the decimal point. Each time **⇄** is pressed the decimal point moves one position to the left until it disappears from the screen. The next press of the button brings the decimal point back at the right side of the screen.

If a flowmeter is used to control or monitor the selected product continue to the next section. If only a pressure sensor is involved go to the Pressure Calibration Section on page 4-3.



When operating under GPS control, Rate “C” becomes the external, “Variable Rate”. Rate “D” becomes the Minimum Allowable Rate and Rate “E” the Maximum Allowable Rate. Rates “A” and “B” are preset rates, which will override the external rate command, when either of them are selected.

**Flowmeter Cal. # Set**

From the screen shown in Fig. 4-4 the initial flowmeter calibration number can be set using the same method as that for the Preset Rates

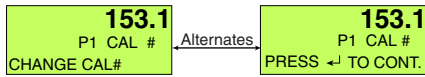

Fig. 4-4 Flowmeter Cal. # Set

(Use and to select the digit and and to adjust the value of the digit). Use the button to adjust the position of the decimal point as described on page 4-2. When the desired value is selected press . If a pressure sensor is also used with this product the next screen is Fig. 4-5. Otherwise the display exits to the “Main Setup” screen (Fig. 4-2).

The flowmeter calibration number represents “Pulses/Gallon” for US units and “Pulses/Liter” for metric units. The flowmeter usually has a tag indicating the “**Initial Calibration Number**” in Pulses/Gallon.

**NOTE:** Before starting actual application, a field test, using water, should be done to verify the accuracy of the Cal. #, and any necessary adjustments made. Use the following formula to calculate a new Cal. #, if necessary:

$$\text{New Cal. \#} = \frac{\text{INDICATED AMOUNT}}{\text{MEASURED AMOUNT}} \times \text{OLD CAL. \#}$$

**Pressure Based Setup**

If a pressure sensor is used to control or monitor the selected product, the low and high pressure values of the sensor must be calibrated to match those of a manual pressure gauge installed near the pressure transducer. This process starts with the “Zero Set Point” screen (Fig. 4-5).

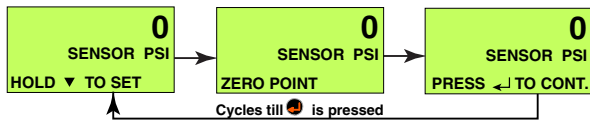



Fig. 4-5 PSI Zero Point Set

From this screen we are setting the “Zero Pressure Reference Point” for the console.

- Operate
- Setup
- Manual
- Left
- Right
- Enter
- Product 1
- Product 2
- Speed
- Area
- Increase
- Decrease



-  Logging On
-  System Error
-  Not Used
-  Manual Mode
-  Control Active
-  Use Enter Key
-  Use Inc/Dec
-  Use Left/Right

- The product pump must be turned OFF.
- At least one boom section of the associated swath must be turned on to ensure that there is no pressure in the boom. (It may be necessary to loosen a diaphragm check valve to relieve all pressure.)
- Press and hold  until the console beeps. The “Zero Reference Point” is now set.

You should now see the screen sequence shown in Fig. 4-6, from which we set the “High Pressure Reference Point”.

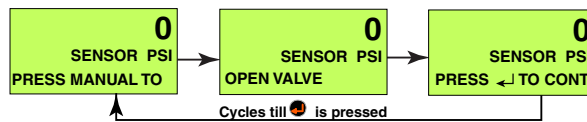







Fig. 4-6 High Set Point

- Be sure to tighten any check valve loosened previously.
- The booms must be off (Master Switch OFF).
- The product pump must be turned ON.
- Slowly increase the engine RPM to adjust the pressure reading on the **manual pressure gauge** to a maximum no higher than the sensor’s specification.
- Set the pressure reading on the console to match that on the manual pressure gauge.

- Use the  and  buttons to select the digit of the display to be changed.
- Use the  and  buttons to adjust the selected digit.
- When the console display has been set to match the pressure gauge press .



**NOTE:** When using dual pressure sensors, both sensors use the same Hi/Low pressure values.

The display reverts to the “Main Setup” screen (Fig. 4-2) unless you are using a pressure sensor to **control** product flow. In this case the screen shown in Fig 4-7



Fig. 4-7 Setting the Nozzle Constant

appears. This screen allows the operator to set the “Nozzle Constant” into the console. The constant should be taken from a nozzle chart for the particular set of nozzles that you are using. Use the 10 MPH/30 PSI value (10KPH/2.0 Bar) for metric operation).

- Use the and buttons to select the digit of the display to be changed.
- Use the and buttons to adjust the selected digit.
- Use the button to adjust the position of the decimal point as described on page 4-2.
- When the constant has been set to the correct value press .

- Operate
- Setup
- Manual
- Left
- Right
- Enter
- Product 1
- Product 2
- Speed
- Area
- Increase
- Decrease

The “Conversion Factor” screen (Fig. 4-8) is now

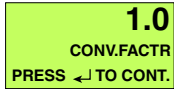

Fig. 4-8 Setting the conversion Factor

displayed. The “Conversion Factor” is normally set to 1.0. If you are spraying a liquid with a specific gravity different than water adjust the Conversion Factor according to the following chart.

<u>Weight of Solution</u>	<u>Conversion Factor</u>
7.0 lbs/gal	.92
8.0 lbs/gal	.98
8.34 lbs/gal (Water)	1.00
9.0 lbs/gal	1.04
10.0 lbs/gal	1.10
10.65 lbs/gal (28% Nitrogen)	1.13
11.0 lbs/gal	1.15
12.0 lbs/gal	1.20
14.0 lbs/gal	1.30



- Use the and buttons to select the digit of the display to be changed.
- Use the and buttons to adjust the selected digit.
- Use the button to adjust the position of the decimal point as described on page 4-2.
- When the factor has been set to the correct value press .







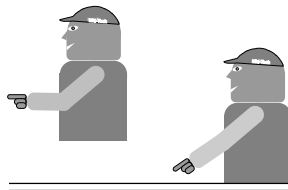

The display now returns to the “Main Setup” screen (Fig. 4-2)

**NOTE:** Before actual application, a field test, using water, should be done to verify the accuracy of the Cal. #, and any necessary adjustments made. Use the following formula to calculate a new Cal. # if necessary:

$$\text{New Cal. \#} = \frac{\text{MEASURED AMOUNT}}{\text{INDICATED AMOUNT}} \times \text{OLD CAL. \#}$$



The formula for flow and pressure based calibration numbers are not the same. Make sure you use the correct one.

-  Logging On
-  System Error
-  Not Used
-  Manual Mode
-  Control Active
-  Use Enter Key
-  Use Inc/Dec
-  Use Left/Right







See the NH<sub>3</sub> Density Chart in Appendix C to determine proper density settings.

## GRANULAR/NH<sub>3</sub> SETUP

With one of the “Granular” or “Anhydrous Modes” selected under “Machine Setup” (Pg. 4-14) press **1** or **2** from the “Main Setup” screen (Fig. 4-2) to enter the “Granular or Anhydrous Setup” function. We are using Product 1 for this example. The first screen displayed will be the “Density Set” screen (Fig 4-9). We will use the



Fig. 4-9 Density Set Screen

“Granular” mode in this example. The “Anhydrous” mode is similar except that NH<sub>3</sub> density is entered in Lb/G (pounds per gallon). Use  and  to adjust the density to the desired value. Use the  button to adjust the position of the decimal point as described on page 4-2. Press  to proceed to the “Preset Rates” setup.







## Preset Application Rates



As many as five different rates (A - E) can be preset into the Legacy 2000 Console.

With the desired “Product Application Mode” selected under “Machine Setup” (Pg. 4-14) press **1** or **2** from the “Main Setup” screen (Fig. 4-2) to enter the appropriate setup function. (We are using “Granular Product 1” for this illustration.) This displays the screen shown in Fig. 4-10. Which indicates that you





Fig. 4-10 Setting preset Rates

are setting Preset Rate “A”, it is being measured in Pounds per Acre and the current value is 81.2 Lb/Ac. The  symbol indicates that you can use the  and  buttons to select which digit of the Rate Value is changed (The flashing digit). The  symbol indicates that you can use the  and  buttons to adjust the value of the flashing digit. When the desired value has been selected press the  button to register the value and advance to the Rate “B” preset screen. This continues until all desired Preset Rates are set.

The  button can be used to move the decimal point. Each time  is pressed the decimal point moves one position to the left until it disappears from the screen. The next press of the button brings the decimal point back at the right side of the screen.

**Granular Cal. # Set**

When Rate “E” has been entered the screen changes to the “Cal. # Set” screen (Fig. 4-11). Use the  and  buttons to select which digit

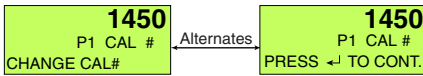







Fig. 4-11 Set Cal. #

of the Cal. Value is changed (The flashing digit). Use the  and  buttons to adjust the value of the flashing digit. When the desired value has been selected press the  button to register the value. When the Cal. # is set and  is pressed the display returns to the “Main Setup” screen (Fig. 4-2).

The  button can be used to move the decimal point. Each time  is pressed the decimal point moves one position to the left until it disappears from the screen. The next press of the button brings the decimal point back at the right side of the screen.

The calibration number represents “Pulses/Ft.<sup>3</sup>” for US units and “Pulses/Decimeter<sup>3</sup> for Metric units. Anhydrous calibration numbers represent ”Pulses/Gal” for US units and “Pulses/ Liter” for Metric units.

**Initial Spreader Constant**









**(Most spreader bed manufacturers furnish a list of spreader constants)**

Calculation of the initial spreader constant requires the following information:

- Gate height (**H**) and width (**W**) in inches
- Number of sensor pulses for each revolution of the spreader rate sensor (**P**)
- The distance the conveyor moves during one revolution of the rate sensor (**D**), in inches.

-  Operate
-  Setup
-  Manual
-  Left
-  Right
-  Enter
-  Product 1
-  Product 2
-  Speed
-  Area
-  Increase
-  Decrease



-  Logging On
-  System Error
-  Not Used
-  Manual Mode
-  Control Active
-  Use Enter Key
-  Use Inc/Dec
-  Use Left/Right



$$\frac{D \times W \times H}{1728} = Ft_r^3$$

Calculate the initial spreader constant as follows:

$$\frac{P}{Ft_r^3} = \text{Initial Calibration Number (Spreader Constant)}$$

Where:  $Ft_r^3$  is the volume discharged, in Cubic Feet, during each revolution of the spreader rate sensor.

It is recommended that an off load test be done to verify the accuracy of the spreader constant. Use the following formula to calculate any corrections needed: When using dual sensors, both use the same Cal. #.

$$\text{New Cal. \#} = \frac{\text{INDICATED AMOUNT}}{\text{MEASURED AMOUNT}} \times \text{OLD CAL. \#}$$

### SEEDER SETUP

When the Legacy 2000 is used to control seed application, the following procedure is used to prepare the console.

With one of the “Seeder Modes” selected under “Machine Setup” (Pg. 4-14) press 1 or 2 from the “Main Setup” screen shown in Fig. 4-2 to enter the “Preset rates” setup.

### Preset Application Rates

As many as five different rates (A - E) can be preset into the Legacy 2000 Console.

With the desired “Product Application Mode” selected under “Machine Setup” (Pg. 4-14) press 1 or 2 from the “Main Setup” screen (Fig. 4-2) to enter the appropriate setup function. (We are using “Seeder Product 1” for this illustration.) This displays the screen shown in Fig. 4-12. Which indicates that you



Fig. 4-12 Setting Preset Rates

are setting Preset Rate “A”, it is being measured in Seeds per Acre and the current value is 18 Seeds/Ac.



(The Cal. # can be adjusted to allow the rates to represent 100's or 1000's of seeds/acre). The  $\blacktriangleleft$  symbol indicates that you can use the  $\blacktriangleleft$  and  $\blacktriangleright$  buttons to select which digit of the Rate Value is changed (The flashing digit). The  $\blacktriangleup$  symbol indicates that you can use the  $\blacktriangleup$  and  $\blacktriangledown$  buttons to adjust the value of the flashing digit. When the desired value has been selected press the  $\bullet$  button to register the value and advance to the Rate "B" preset screen. This continues until all desired Preset Rates are set.

The  $\text{⊖}$  button can be used to move the decimal point. Each time  $\text{⊖}$  is pressed the decimal point moves one position to the left until it disappears from the screen. The next press of the button brings the decimal point back at the right side of the screen.

**Seeder Cal # Set**

When Rate "E" has been entered the screen changes to the "Cal. # Set" screen (Fig. 4-13). Use the  $\blacktriangleleft$  and  $\blacktriangleright$  buttons to select which digit

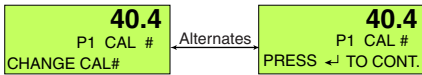

Fig. 4-13 Set Cal. #

of the Cal. Value is changed (The flashing digit). Use the  $\blacktriangleup$  and  $\blacktriangledown$  buttons to adjust the value of the flashing digit. When the desired value has been selected press the  $\bullet$  button to register the value. When the Cal. # is set and  $\bullet$  is pressed the display returns to the "Main Setup" screen (Fig. 4-2).

The  $\text{⊖}$  button can be used to move the decimal point. Each time  $\text{⊖}$  is pressed the decimal point moves one position to the left until it disappears from the screen. The next press of the button brings the decimal point back at the right side of the screen.



The calibration number represents "Pulses/Seed, Tuber, Pound, or Kilogram" for US units and "Pulses/Seed, Tuber, or Kilogram" for metric units.

**NOTE:** Before starting actual application, a test run should be done to verify the accuracy of the Cal. #, and any necessary adjustments made. Use the following formula to calculate a new Cal. #, if necessary:

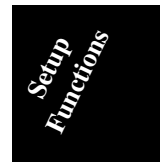

- $\bullet$  Operate
- $\text{⊖}$  Setup
- $\text{⊕}$  Manual
- $\blacktriangleleft$  Left
- $\blacktriangleright$  Right
- $\bullet$  Enter
- $\text{1}$  Product 1
- $\text{2}$  Product 2
- $\text{⊖}$  Speed
- $\text{⊕}$  Area
- $\blacktriangleup$  Increase
- $\blacktriangledown$  Decrease



-  **Logging On**
-  **System Error**
-  **Not Used**
-  **Manual Mode**
-  **Control Active**
-  **Use Enter Key**
-  **Use Inc/Dec**
-  **Use Left/Right**



$$\text{New Cal. \#} = \frac{\text{INDICATED AMOUNT}}{\text{MEASURED AMOUNT}} \times \text{OLD CAL. \#}$$

When the Cal # is set and  is pressed the display returns to the “Main Setup” screen (Fig. 4-2).

When using dual sensors, both use the same Cal. #.

### SPINNER MODE SETUP

The Legacy 2000 console can control the Spinner Speed of one or two spinners on a granular vehicle.

With the “Spinner Mode” selected under “Machine Setup” (Pg. 4-14) press  or  from the “Main Setup” screen (Fig. 4-2) to enter the “Preset rates” setup.

### Preset Spinner Rates

As many as five different rates (A - E) can be preset into the Legacy 2000 Console.











With the desired “Spinner Mode” selected under “Machine Setup” (Pg. 4-14) press  or  from the





Fig. 4-14 - Setting Preset Rates

“Main Setup” screen (Fig. 4-2) to enter the appropriate setup function. (We are using “Product 1” for this illustration.) This displays the screen shown in Fig. 4-14. Which indicates that you are setting Preset Rate “A”, it is being measured in Revolutions per Minute and the current value is 40.4 RPM. The  symbol indicates that you can use the  and  buttons to select which digit of the Rate Value is changed (The flashing digit). The  symbol indicates that you can use the  and  buttons to adjust the value of the flashing digit. When the desired value has been selected press the  button to register the value and advance to the Rate “B” preset screen. This continues until all desired Preset Rates are set.

The  button can be used to move the decimal point. Each time  is pressed the decimal point moves one position to the left until it disappears from the screen. The next press of the button brings the decimal point back at the right side of the screen.

**Spinner Cal # Set**

**W**hen Rate “E” has been entered the screen changes to the “Cal. # Set” screen (Fig. 4-15). Use the  and  buttons to select which digit

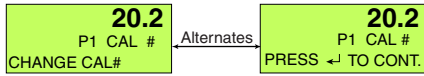









Fig. 4-15 Set Cal. #

of the Cal. Value is changed (The flashing digit). Use the  and  buttons to adjust the value of the flashing digit. When the desired value has been selected press the  button to register the value. When the Cal. # is set and  is pressed the display returns to the “Main Setup” screen (Fig. 4-2).

The  button can be used to move the decimal point. Each time  is pressed the decimal point moves one position to the left until it disappears from the screen. The next press of the button brings the decimal point back at the right side of the screen.

The Cal #. represents the number of pulses generated during each revolution of the spinner. When using dual sensors, both use the same Cal. #.

When the Cal # is set and  is pressed the display returns to the “Main Setup” screen (Fig. 4-2).

**INJECTION PRIME/CALIBRATE FUNCTION**

**I**f your system includes an injection pump, that pump must be calibrated for maximum accuracy. To enter the “Inj. Pump Setup” function press  from the “Main Setup” screen (Fig. 4-2). If both chemical channels are selected as injection channels (see Product Selection under “Product Modes”) the “Injection Pump select” screen (Fig. 4-16) appears.

-  Operate
-  Setup
-  Manual
-  Left
-  Right
-  Enter
-  Product 1
-  Product 2
-  Speed
-  Area
-  Increase
-  Decrease

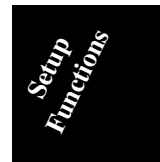

- ☐ Logging On
- ⚠ System Error
- △ Not Used
- ☞ Manual Mode
- ⬆ Control Active
- ↵ Use Enter Key
- ▲▼ Use Inc/Dec
- ▶◀ Use Left/Right



Fig. 4-16 Injection Pump Select

Use the ▲ or ▼ to select which pump you want to setup and press ☞.

The “Prime/Cal Select” screen appears next. Use ▲ or ▼ to alternate between Prime (Fig. 4-17) or Cal. (Fig.



Fig. 4-17 Prime Function Selected

4-21) setup screens. When the desired function is displayed press ☞.

**Prime Function**

The “Prime Volume” screen is shown in Fig. 4-18. Use the ▲ and ▼ to select the digit to be changed. The ▲ and ▼ buttons are used to set



Fig. 4-18 - Prime Volume Screen

the digit to the desired value. Use the 🌀 button to adjust the position of the decimal point as described on page 4-2. When the Prime Volume has been entered into the console press ☞ to start the Priming process. You now see the “Pump Prime” screen (Fig. 4-19).

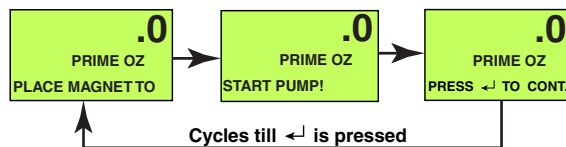

Fig. 4-19 Pump Prime Screen

Place the magnet in the **lower right** corner of the PCM

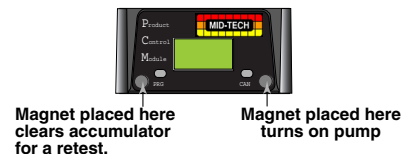

Fig 4-20 PCM Magnet Placement

as shown in Fig. 4-20. This turns on the injection pump and the number of ounces pumped accumulates on the screen. When the amount pumped reaches the preset prime value the pump stops.

**Calibrate Function**

The “Calibrate Function is entered by pressing  from the “Cal Function Select” screen (Fig. 4-21). This brings up the “Pump Cal Run” screen (Fig. 4-22). When your calibration container is



Fig. 4-21 Cal Function Selected

positioned to catch the liquid from the injection pump

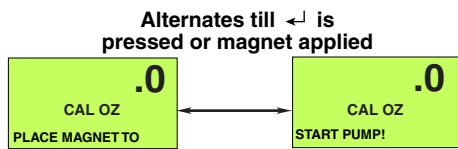

Fig. 4-22 Pump Cal. Run

place the magnet in the **lower right** corner of the PCM as shown in Fig. 4-20 to turn on the pump. The screen changes to the one shown in Fig. 4-23 and ounces start accumulating on the display. When the desired amount

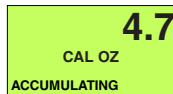

Fig. 4-23 - Product Accumulating





of liquid has been collected remove the magnet from the PCM. The screen changes to the one shown in Fig. 4-24. Using the , , , and  arrow buttons, the amount shown on the display can be adjusted to match













Fig. 4-24 Cal. Volume correction

the amount actually collected. When the “Amount Displayed” matches the “Amount Collected” press . This corrects the calibration number and returns you to the screen in Fig. 4-22. If you want to do another Calibration run to verify your test, place the magnet in



-  Operate
-  Setup
-  Manual
-  Left
-  Right
-  Enter
-  Product 1
-  Product 2
-  Speed
-  Area
-  Increase
-  Decrease



-  **Logging On**
-  **System Error**
-  **Not Used**
-  **Manual Mode**
-  **Control Active**
-  **Use Enter Key**
-  **Use Inc/Dec**
-  **Use Left/Right**

the **lower left** corner of the PCM, as shown in Fig. 4-20, to clear the Volume Accumulator and perform the catch test as before. When you are satisfied with the results press  or  to exit the procedure.

### MACHINE SETUP

In this section we are entering information concerning the product type and units of measure being used and configuring the modules controlling the application process. To enter the “Machine Setup” function press , then  or  (for Product 1 or 2) and hold the button for three seconds.

### PRODUCT MODES

The first screen displayed is the “Product Select” screen (Fig. 4-25) from which the type of product and



Fig. 4-25 Product select screen

control are chosen. The product modes available are shown in Table 4-1. **The product mode chosen at**

<b>Liquid</b>	- Flowmeter - Flowmeter/Pressure Sensor - Pressure Sensor - Dual Pressure Sensors - Reflow
<b>Injection Spinner</b>	- Liquid - Single Sensor - Dual Sensors
<b>Seeder</b>	- Split Drive/Single Sensor - Split Drive/Dual Sensors - Standard
<b>Granular</b>	- Split Drive/Single Sensor - Split Drive/Dual Sensors - Standard
<b>NH<sub>3</sub></b>	- Flowmeter - Flowmeter/Pressure Sensor

Table 4-1 - Product Modes





**this point determines what setup choices are available later.** Use the  and  buttons to select the correct Product Mode for your application. Press  to move on to the “Units select” screen (Fig. 4-26)



Fig. 4-26 Units Select Screen

APPLICATION UNITS OF MEASURE

Use the  and  buttons to select the desired units of measure for your application (Table 4-2), indicates the Units of Measure available for

-  Operate
-  Setup
-  Manual
-  Left
-  Right
-  Enter
-  Product 1
-  Product 2
-  Speed
-  Area
-  Increase
-  Decrease

US	EU
<b>Liquid</b>	
Gallons/Acre ( <i>G/Ac</i> )	Liters/Hectare ( <i>Lt/Ha</i> )
Gallons/Minute ( <i>G/MIN</i> )	Liters/Minute ( <i>Lt/Min</i> )
Gallons/Lane Mile ( <i>G/LnMi</i> )	Liters/Lane Kilometer ( <i>Lt/LnKm</i> )
Gallons/1000 Feet <sup>2</sup> ( <i>G/1000Ft<sup>2</sup></i> )	Liters/100 Meters <sup>2</sup> ( <i>Li/100 M<sup>2</sup></i> )
Gallons/100 Yard <sup>2</sup> ( <i>G/100Yd<sup>2</sup></i> )	Liters/Kilogram ( <i>Lt/Kg</i> )
Gallons/Pound ( <i>G/Lb</i> )	Liters/100 Liters ( <i>Lt/100 Lt</i> )
Gallons/100 Gallons ( <i>G/100G</i> )	
Liters/Acre ( <i>Lt/Ac</i> )	
<b>Injection</b>	
Ounces/Acre ( <i>OZ/Ac</i> )	Liters/Hectare ( <i>Lt/Ha</i> )
Ounces/Gallon ( <i>OZ/G</i> )	Liters/Liter ( <i>Lt/Lt</i> )
Ounces/1000 Ft <sup>2</sup> ( <i>OZ/1000Ft<sup>2</sup></i> )	Liters/100 Meters <sup>2</sup> ( <i>Lt/100 M<sup>2</sup></i> )
Ounces/100 Yard <sup>2</sup> ( <i>OZ/100Yd<sup>2</sup></i> )	Liters/Lane Kilometer ( <i>Lt/LnKm</i> )
Ounces/Lane Mile ( <i>OZ/LnMi</i> )	Liters/Kilogram ( <i>Lt/Kg</i> )
Ounces/Pound ( <i>OZ/Lb</i> )	Liters/Minute ( <i>Lt/MIN</i> )
Ounces/Minute ( <i>OZ/MIN</i> )	Liters/100 Liters ( <i>Lt/100LT</i> )
Ounces/100 grams ( <i>OZ/100 G</i> )	
Liters/acre ( <i>Lt/Ac</i> )	
<b>Spinner</b>	
Revolutions/Minute ( <i>RPM</i> )	Revolutions/Minute ( <i>RPM</i> )
<b>Seeder</b>	
Seeds/Acre ( <i>SEED/Ac</i> )	Seeds/Hectare ( <i>SEED/Ha</i> )
Tubers/Acre ( <i>TUBER/Ac</i> )	Tubers/Hectare ( <i>TUBERS/Ha</i> )
Pounds/Acre ( <i>Lb/Ac</i> )	Kilograms/Hectare ( <i>Kg/Ha</i> )
Kilograms/Acre ( <i>Kg/Ac</i> )	
<b>Granular</b>	
Pounds/Acre ( <i>Lb/Ac</i> )	Kilograms/Hectare ( <i>KG/Ha</i> )
Pounds/1000 Feet <sup>2</sup> ( <i>Lb/1000 Ft<sup>2</sup></i> )	Kilograms/100 Meters <sup>2</sup> ( <i>Kg/100M<sup>2</sup></i> )
Pounds/100 Yards <sup>2</sup> ( <i>Lb/100 Yd<sup>2</sup></i> )	Kilograms/Lane Kilometer ( <i>Kg/LnKm</i> )
Pounds/Lane Mile ( <i>Lb/LnMi</i> )	Kilograms/Liter ( <i>Kg/Lt</i> )
Pounds/Gallon ( <i>Lb/G</i> )	Metric Tons/Lane Kilometer ( <i>mTN/LnKm</i> )
Tons/Lane Mile ( <i>TN/LnMi</i> )	Metric Tons/Hectare ( <i>mTN/Ha</i> )
Tons/Acre ( <i>TN/Ac</i> )	Kilograms/Minute ( <i>Kg/MIN</i> )
Pounds/Minute ( <i>Lb./MIN</i> )	Metric Tons/Hour ( <i>mTN/HOUR</i> )
Tons/Hour ( <i>TN/HOUR</i> )	Kilograms/Kilometer ( <i>Kg/Km</i> )
Pounds/Mile ( <i>Lb/Mi</i> )	Metric Tons/Kilometer ( <i>mTN/Km</i> )
Tons/Mile ( <i>TN/Mi</i> )	Kilograms/Metric Ton ( <i>Kg/mTN</i> )
Pounds/Ton ( <i>Lb/TN</i> )	Kilograms/100 Liters ( <i>Kg/100Lt</i> )
Pounds/100 Gallons ( <i>Lb/100G</i> )	
Kilograms/Acre ( <i>Kg/Ac</i> )	
<b>NH<sub>3</sub></b>	
Pounds/Acre ( <i>Lb/Ac</i> )	Kilograms/Hectare ( <i>Kg/Ha</i> )
Kilograms/Acre ( <i>Kg/Ac</i> )	



Table 4-2 - Units of Measure

each Product Mode.) Pressing  at this point takes you to the “Valve/Drive Select” Screen (Fig. 4-27).

- ☐ Logging On
- ⚠ System Error
- △ Not Used
- ☞ Manual Mode
- ⬆ Control Active
- ↵ Use Enter Key
- ▲▼ Use Inc/Dec
- ▶◀ Use Left/Right



Fig. 4-27 Valve/Drive Select Screen

### VALVE/DRIVE TYPES

The valve or drive types available depend on the Product Mode selected earlier and only the valid types appear in this setup routine. The choices are shown in Table 4-3. Use the ▲ and ▼ buttons to select the desired type and press ↵ to register the selection and move you to the proper setup sequence.

Liquid/Spinner/NH3	- Servo Valve ( <i>SERVO</i> ) - Pulse Width Modulated ( <i>PWM</i> )
Granular/Seeder	- Servo Valve ( <i>SERVO</i> ) - Pulse Width Modulated ( <i>PWM</i> )
Injection	- Peristaltic Drive ( <i>PERiS</i> )

Table 4-3 Valve/Drive Types

buttons to select the desired type and press ↵ to register the selection and move you to the proper setup sequence.

### Servo Valve Setup

The first “Servo Valve” setup screen is the “Valve Speed Select” screen (Fig. 4-28).



Fig. 4-28 Valve Speed Select

Valve Speed is how fast the valve reacts when the application is off target. This value can be adjusted to allow the quickest rate correction without overshooting the target rate. Increasing the “Valve Speed” number makes the valve respond faster. A lower number causes the valve to respond slower.

Use the ▲, ▼, ▶, and ◀ buttons to set the desired “Drive speed” and press ↵. This takes you to the “Status Switch OFF” valve response screen (Fig. 4-29).

When the “HOLD” condition is selected, opening the Implement Status Switch causes the Flow Control



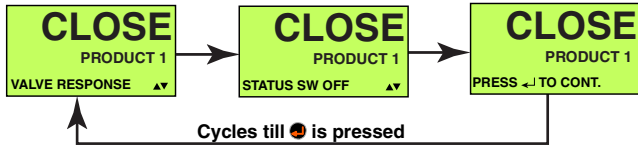

Fig. 4-29 Status switch OFF Valve Response

Valve to hold in its current position. When the Implement Status Switch is closed the Flow Control Valve is already open and product flow is instantaneous. This response assumes that some other device, such as a solenoid dump valve, has stopped the product flow.

When the “CLOSE” condition is selected, opening the Status Switch automatically causes the Flow Control Valve to close. This response is preferred when it is necessary to use the Flow Control Valve to stop the product flow.

If setting up a PWM valve (chosen in the previous section) an additional selection (RESUM) is included at this point.

When “RESUM” is selected and the Status Switch is turned on (closed), the valve is immediately furnished the same Duty Cycle drive that was being furnished when the Status switch was turned OFF (opened).

Use the ▲ and ▼ buttons to select either HOLD or CLOSE response for the “Status switch OFF” condition and press [stop icon].

The next screen is the “Booms OFF” valve response screen (Fig. 4-30).

When the “HOLD” condition is selected, an “All











Fig. 4-30 Booms OFF Valve Response

Booms OFF” condition causes the Flow Control Valve to hold its current position. When the booms are turned “ON” again the Flow Control Valve is already open and product flow is instantaneous.

When the “CLOSE” condition is selected, an “All Booms OFF” condition (all Boom Switches “OFF” or

- ⊙ Operate
- 📖 Setup
- 👉 Manual
- ⬅️ Left
- ➡️ Right
- ⏎ Enter
- 1 Product 1
- 2 Product 2
- 🏎 Speed
- 📦 Area
- ▲ Increase
- ▼ Decrease



-  Logging On
-  System Error
-  Not Used
-  Manual Mode
-  Control Active
-  Use Enter Key
-  Use Inc/Dec
-  Use Left/Right

Master Switch “OFF”) automatically causes the Flow Control Valve to CLOSE. This response is used when the Flow Control Valve is used to stop the product flow.

If setting up a PWM valve (chosen in the previous section) an additional selection (RESUM) is included at this point.

When “RESUM” is selected and the Booms are turned on, the valve is immediately furnished the same Duty Cycle drive that was being furnished when they were turned OFF.







The “Booms OFF” response is selected in the same manner as the “Status Switch OFF” response. Press  to move to the “Valve Delay Time” screen (Fig. 4-31).



Fig. 4-31 Valve Hold Delay Setup

This is the time the valve waits, after coming out of a HOLD condition, before resuming automatic control. This feature is used to allow the flow dynamics, present when a sprayer boom is first turned on, to stabilize before the system starts reacting to the rate it is calculating from the flow sensor.

The “Delay Time” value is set using the , , , and  buttons. Pressing  takes you to the “Start Up Drive % Duty Cycle” screen (Fig. 4-32).

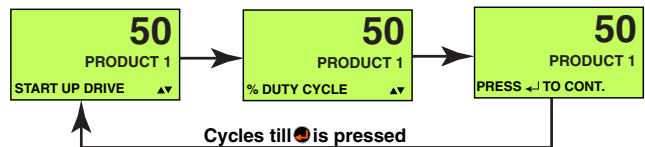

Fig. 4-32 Start Up % Duty Cycle

The Start Up % Duty Cycle is the amount of drive signal which opens the valve from a dead closed position until sensor response is achieved and stabilized.





The “% Duty Cycle” value is set using the , , , and  buttons. Pressing  takes you to the “Swath Assignment” screen (Fig. 4-33).



Fig. 4-33 Swath Assignment

If you have set up more than one swath the screen will look similar to Fig. 4-34 which displays a dash for



Fig. 4-34 Swaths Available

each programmable swath (1 - 5 from left to right). Use and to select the swath that you wish to assign to this product. Press to make the assignment. The swath number appears in place of the dash for the chosen swath. A product can be assigned to more than one swath so assign any other swaths desired at this time. Fig. 4-35 shows all five possible swaths available

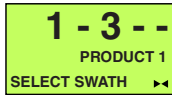

Fig. 4-35 Swaths Assigned

with swaths 1 and 3 assigned to Product 1. To un-assign a swath, select the swath with or and press . The selected swath number reverts back to a dash.

Press to move to the final screen for the “Servo Valve Setup” routine (Fig. 4-36). This screen activates

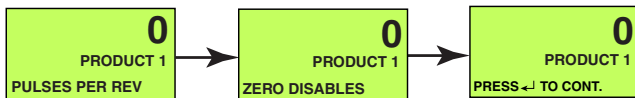

Fig. 4-36 RPM Setup Screen

an auxiliary sensor input which can be used to monitor the RPM of any desired function and display the RPM on the third line of the Product screens (as shown in Fig. 3-4). For instance you may want to monitor the spinner RPM on a spreader truck.

Use and , to set the number of sensor pulses that are generated during each revolution of the unit being monitored, and press to register the number (If the number is set to zero this feature is disabled and does not show up in the third line of the Product display.)

- Operate
- Setup
- Manual
- Left
- Right
- Enter
- Product 1
- Product 2
- Speed
- Area
- Increase
- Decrease



-  Logging On
-  System Error
-  Not Used
-  Manual Mode
-  Control Active
-  Use Enter Key
-  Use Inc/Dec
-  Use Left/Right

The display now returns to the “Main Setup” screen (Fig. 4-2).

### PWM Valve Setup

The first “Pulse Width Modulated (PWM) Valve” setup screen is the “PWM Frequency” screen (Fig. 4-37).



Fig. 4-37 PWM Frequency Setup





This value is provided by the PWM valve or machine supplier (Use default of 100 for electric motor drive, unless otherwise recommended by MID-TECH Customer Service). All of the PWM screen values are adjusted in the same manner. Use  and  to select the digit to be adjusted and  and  to set the desired value. Press  to take you to the “Max Duty Cycle” screen (Fig. 4-38). This value is provided by the valve



Fig. 4-38 PWM Max Duty cycle Setup

or machine supplier. Press  to take you to the “Min. Duty Cycle” screen (Fig. 4-39). This value is provided



Fig. 4-39 PWM Min Duty cycle Setup

by the valve or machine supplier. Press  to take you to the “PWM % Dither” screen (Fig. 4-40). This value



Fig. 4-40 PWM % Dither Setup

fine tunes a sticky valve. This value defaults to 4 and should not be changed unless recommended by Customer Service. Set to zero for electric motor drive. Press  to take you to the “Ramp Time” screen (Fig. 4-41). Ramp Time is how fast a PWM valve reacts when the application is off target. The longer the time, the slower the valve will be to react to changes.



Fig. 4-41 PWM Ramp Time Setup

Pressing takes you to the “Valve Speed Select” screen (Fig. 4-28 under “Servo valve setup”). The Valve Speed function is not used by the PWM valve so press to take you to the “Status Switch OFF” screen and Proceed through the “Servo Valve” setup as described on page 4-16, after which the display returns to the “Main Setup” screen (Fig. 4-2).

### Injection Drive Setup

The first “Injection drive” setup screen is the “Product Linking” screen (Fig. 4- 42). Pressing links the selected product to the other



Fig. 4-42 Product Linking

product. For instance, in the example shown, pressing links Product 1 to Product 2 as shown in Fig. 4-43.



Fig. 4-43 Product 1 Linked to Product 2









In this case Product 1 would only be applied when Product 2 is being applied. Pressing unlinks the products.

Pressing returns the display to the “Main Setup” screen (Fig. 4-2).

If the injected product is linked to another product it is automatically assigned to the same swath as the control product. If not linked to another product the next three screens are the same as those in Figs. 4-34, 4-35, and 4-36 and the Injection Drive setup follows the same instructions as those given in that section. The display returns to the “Main Setup” screen when that setup is completed.

- Operate
- Setup
- Manual
- Left
- Right
- Enter
- Product 1
- Product 2
- Speed
- Area
- Increase
- Decrease





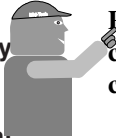



-  Logging On
-  System Error
-  Not Used
-  Manual Mode
-  Control Active
-  Use Enter Key
-  Use Inc/Dec
-  Use Left/Right



## SYSTEM SETUP

This section deals with the entering of basic system information such as System Units & Date & Time, setting COM Ports, performing system tests, etc. Most of these functions should have to be performed only once unless there is a problem.

Pressing  or  at any point takes you out of the current setup function without making any changes.

To enter the “System Setup” mode press and hold  for three seconds. This takes you to the “System Setup/System Units” screen shown in Fig. 4-44 - #1. Pressing  or  allows you to step through the “System Setup” screens (Fig. 4-44). When the desired function screen is displayed press  to enter that setup routine.

## SYSTEM UNITS

This function allows the selection of either “US” or “EU” (metric) units of measurement for speed, volume, rate etc.. While in the “System Units” setup screen, (Fig. 4-44 - #1), pressing  takes you to one of the “Change Units” screens shown in Fig. 4-45 which displays the currently selected

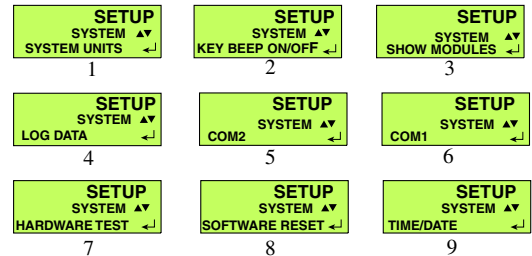

Fig. 4-44: System Setup Screens



**WARNING!** When the “Units of Measure” is changed, all distance, area and volume accumulations are reset to zero and rates will revert to default values.

takes you to one of the “Change Units” screens shown in Fig. 4-45 which displays the currently selected

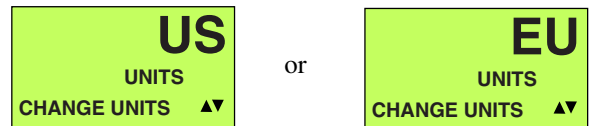

Fig. 4-45: Change Units Screen

system units. Use  and  to change the system units if necessary.

When the “Units of Measure” is about to be changed the “ALERT Screens” shown in Fig. 4-46 are displayed.

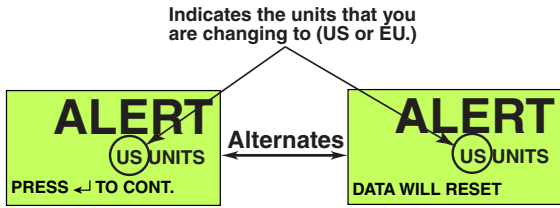

Fig. 4-46: Unit Alert Screen

To make the change press . To cancel the change press .

### KEY BEEP

The Legacy console beeps each time a button is pressed. To disable this feature select the “Key Beep” screen (Fig. 4-44 - #2) and Press to get to the screen shown in Fig 4-47. Use the or to

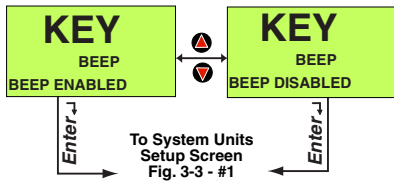

Fig. 4-47: Key Beep Screen

select “Key Beep” ON or OFF. When the desired choice is being displayed press .

### SHOW MODULES

In the “Show Modules” mode the operator can select each system module (Console, PSM, SSM, PCM) and display its Serial Number, Software Version and “On-line/Off-line status”. Select the “Show Modules” screen (Fig. 4-44 - #3) and press . Use or to select the desired module. The screen alternates between the module serial number and software version as shown in Fig. 4-48. Pressing











Fig. 4-48: Show Modules Screen

takes you back to the “System Setup” screen (Fig. 4-44 - #1).

- Operate
- Setup
- Manual
- Left
- Right
- Enter
- Product 1
- Product 2
- Speed
- Area
- Increase
- Decrease



-  Logging On
-  System Error
-  Not Used
-  Manual Mode
-  Control Active
-  Use Enter Key
-  Use Inc/Dec
-  Use Left/Right

**LOG DATA**

In addition to controlling chemical application the Legacy console can also record (log) a variety of operations data such as speed, target and actual application rates, areas treated, error messages, etc..



To enable this feature select the “Log Data” screen (Fig. 4-44 - #4) and press  which takes you to the “Log Destination” Screen (Fig. 4-49.) Use  and  to



Fig. 4-49: Log Destination Screen





select the destination for your Log Data (SRAM Card (See caution at side), COM 1, COM 2.) When the desired destination is being displayed press  bringing up the “Time Logging” screen (Fig. 4-50.) Using 



Fig. 4-50: Time Logging Screen

and , select the rate (in one second increments) at which log data is to be recorded. Pressing  selects the desired time interval and returns the console to the “Main Setup” screen (Fig. 4-2).

If the logging interval is set to zero (Time Logging not being used) the “Event Logging” screen (Fig. 4-51) is



Fig. 4-51: Select Logging Event

displayed when  is pressed. Data can then be logged when certain, user selected, events occur. From the screen in Fig. 4-52 any or all of the following system events can be selected to trigger the logging of information.

- Stop/Go
- Change in Application Width
- Product ON/OFF
- Product rate change



**CAUTION:** Always make sure the Legacy console is powered down before inserting or removing the SRAM card.





Use ▲ and ▼ to scroll through the event selections. When an event is displayed that you want to change, press ▶ to select the event or ◀ to deselect the event. The screen (Fig. 4-52) shows “Rate Change” selected



Fig. 4-52: Event Select Screen

as one of the events that will trigger the logging of a record (an \* is shown next to the event.)

### COM PORTS

Before the console can communicate with an external device, such as a computer, GPS receiver, data recording device, etc., the proper COM port (COM 1, COM 2) must be enabled and configured to match the device involved.

To set up a COM port, select the proper “COM Port” screen (Fig. 4-44, - #5 or #6) and press ●. This takes you to the setup screen shown in Fig. 4-53. The



Fig. 4-53: COM Port Mode Screen

screens and procedures are the same for both COM ports except for the port number that is displayed. We are using COM 2 in our example.

Use ▲ and ▼ to select the port status desired (OFF, NMEA 183, MT PROTO). Press ● again to take you to the “Baud Rate” setup screen (Fig. 4-54). Use ▲

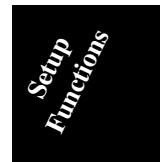



Fig. 4-54: COM Port Baud Rate Screen

and ▼ to select the desired port communication speed

- 1200 BPS
- 2400 BPS
- 4800 BPS
- 9600 BPS
- 19200 BPS

- Operate
- 📖 Setup
- 👉 Manual
- ◀ Left
- ▶ Right
- ⏎ Enter
- 1 Product 1
- 2 Product 2
- 🚗 Speed
- 📏 Area
- ▲ Increase
- ▼ Decrease



-  Logging On
-  System Error
-  Not Used
-  Manual Mode
-  Control Active
-  Use Enter Key
-  Use Inc/Dec
-  Use Left/Right

and press .

### HARDWARE TEST

The “Hardware Test” function verifies the proper operation of the console screen display segments and input buttons.

To start the test select the “Hardware Test” screen (Fig. 4-44 - #7) and press . This takes you to the “Display Segment Test” screen ( Fig. 4-55). All of the

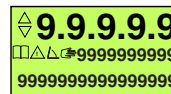

Fig. 4-55: Display segment Test

digits cycle from 0 through 9. The decimal points and symbols then light up. This sequence is repeated until  is pressed. The console then proceeds to the “Input Button” test screen (Fig. 4-56). As each button on the



Fig. 4-56: Button Test Screen

console is pressed its name appears on the screen as shown in the Fig. 4-57 for the “Operate” button test.

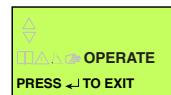



Fig. 4-57: Operate Button Test

Press the  button last as this will terminate the test and send the console back to the “System Units Setup” screen (Fig. 4-44 - #1)

### SOFTWARE RESET



When a software reset is required select the “Software Reset” screen (Fig. 4-44 - #8) and press . The “Alert” screens shown in Fig. 4-58 appear. Pressing  at this point takes you back



Fig. 4-58: Reset Alert Screen

to the “Main Setup” screen (Fig. 4-2) without performing the reset.

Pressing  initiates the reset procedure. The system goes through the normal “Start-up” routine as described on page 2-1.

**WARNING: During this “System Reset” routine all system variables are reset to factory default values and all accumulators are reset to zero.**



-  Operate
-  Setup
-  Manual
-  Left
-  Right
-  Enter
-  Product 1
-  Product 2
-  Speed
-  Area
-  Increase
-  Decrease

### TIME AND DATE

To set the system date and time (should only have to be set once) select the “Time/Date” screen (Fig. 4-44 - #9) and press . This takes you to the top pair of screens shown in Fig. 4-59. Follow the

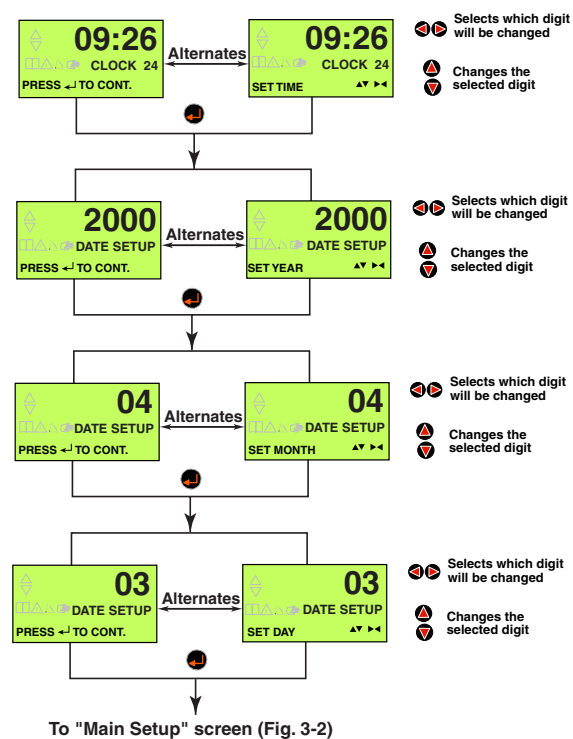





Fig. 4-59: Set Time and Date

instructions at the right of the figure to set each value.

When the desired value is shown press  to take you to the next pair of screens. When  is pressed from the “Set Day” screen the operator is taken back to the



-  Logging On
-  System Error
-  Not Used
-  Manual Mode
-  Control Active
-  Use Enter Key
-  Use Inc/Dec
-  Use Left/Right

“Main Setup” screen (Fig. 4-2)

## SPEED SETUP

### SPEED CALIBRATION

The next step is to calibrate the speed sensor. From the “Main Setup” screen (Fig. 4-2) press  to enter the “Speed Setup” routine. The display cycles through the series of screens shown in Fig. 4-60. The current Speed Calibration number is

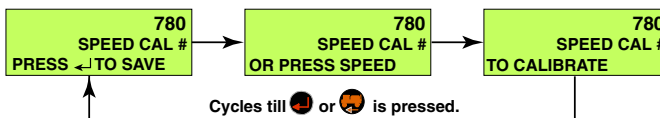





Fig. 4-60: Speed Setup Screen

shown on the top line of the screen.  and  can be used to adjust the Cal. # if necessary. Pressing  takes you to the “Speed Cal.” screen shown in Fig. 4-61. The

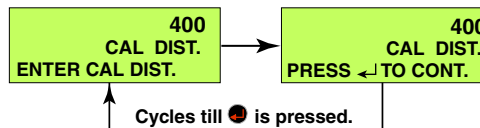





Fig. 4-61: Speed Cal. Screen

current calibration distance is shown in the first line.  and  can be used to adjust the value to agree with the calibration distance you have marked off. Pressing  at this point actually starts the calibration process. The “Cal. Start” screen (Fig. 4-62) is shown. When the

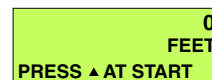



Fig. 4-62: Speed Cal. Start

vehicle is at the start of the measured calibration distance press . The “Cal. In Process” screen (Fig. 4-63) appears with the “distance from start” shown on

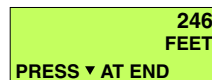

Fig. 4-63: Speed Cal. In Process

the top line. When the vehicle reaches the end of the measured distance press . The screen shown in Fig.

4-64 appears with the distance actually driven shown

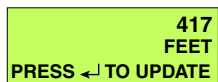

Fig. 4-64: Speed Cal. End

on the first line. Pressing automatically updates the “Speed Cal. #” value. Pressing exits the Speed Calibration function without changing the “Speed Cal. #” value.

### GSO SETUP

If is pressed from the screen in Fig. 4-60 the Ground Speed Override (GSO) setup function is entered. The screen shown in Fig. 4-65 is displayed.

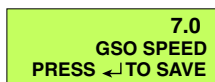

Fig. 4-65 GSO Setup

Use and to set the desired GSO speed. Press to save the value to memory and return you to the “Main Setup” screen (Fig. 4-2).

### BOOM SETUP

In the ‘Boom Setup’ function we enter the number of active boom sections and the width of each individual section.

From the “Main Setup” screen (Fig. 4-2) press to enter the “Boom Setup” function. The first screen is shown in Fig. 4-66. Use and to set the number of

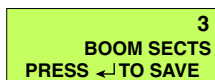

Fig. 4-66: Active boom sections

active boom sections the vehicle is using. Press to save the value to memory and move you to the “Boom Width” setup screen (Fig. 4-67). The boom number

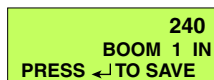









Fig. 4-67: Boom Widths

being set is shown on the second line. Use and to

- Operate
- Setup
- Manual
- Left
- Right
- Enter
- Product 1
- Product 2
- Speed
- Area
- Increase
- Decrease



-  **Logging On**
-  **System Error**
-  **Not Used**
-  **Manual Mode**
-  **Control Active**
-  **Use Enter Key**
-  **Use Inc/Dec**
-  **Use Left/Right**



set the width (in inches/centimeters) of the boom section being displayed. Press  to register the value. The same screen reappears for each active boom section. When the last width is entered the display goes back to the “Main Setup” screen (Fig. 4-2).

### SWATH SETUP

A swath is a boom section or a group of boom sections that accumulate area as a group. For instance you may have three active boom sections. The center section might be applying a burn down herbicide to kill the weeds between rows of fruit trees while the left and right sections are applying a milder herbicide to stunt the weeds under the trees without damaging the trees. The left and right sections could be assigned as Swath 1 and the center section as Swath 2. Each swath would accumulate area independently. The “Swath Setup” routine allows you to make these types of assignments.

From the “Main Setup” screen (Fig. 4-2) press  and hold it for three seconds to enter the “Swath Setup” function.

### NUMBER OF SWATHS

The first screen (Fig. 4-68) allows you to set the number of active swaths (max. - 5). Use  and  to set the number of active swaths the vehicle



**NOTE: After changing the number of swaths, the products must be assigned/reassigned to the swaths**

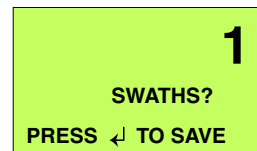





Fig. 4-68: Active Swaths

is using. Press  to enter the value into memory and move you to the “Boom Assignment” function.

### BOOM ASSIGNMENT

The “Boom Assignment” screen is shown in Fig. 4-69. The boom section being assigned is shown on the middle line of the screen. Use  and  to select the swath number that the boom section is to

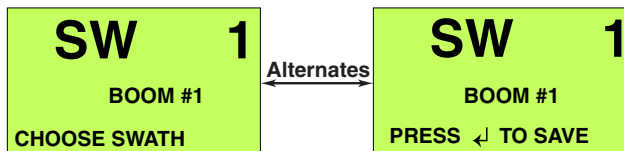

Fig. 4-69: Boom/Swath Assignment

be assigned to and press . The “Boom Assignment” screen re-appears for each active boom section. Repeat this procedure until all boom sections have been assigned to swaths. After the last boom section has been assigned the display returns to the “Main Setup” screen (Fig. 4-2).

### GPS SPEED SETUP

From the “Main Setup” screen (Fig. 4-2) press and hold for three seconds to turn on or off the GPS speed input to the Legacy 2000 system. The screen shown in Fig. 4-70 appears. The center line indicates the

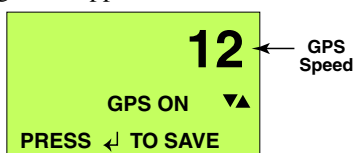

Fig. 4-70: GPS Setup Screen

current status of the GPS Speed function (ON or OFF). Use and to toggle between “GPS ON” and “GPS OFF”. When the desired selection is displayed press to save the value to memory and return you to the “Main Setup” screen (Fig. 4-2).

- Operate
- Setup
- Manual
- Left
- Right
- Enter
- Product 1
- Product 2
- Speed
- Area
- Increase
- Decrease



This page left blank intentionally



**Chapter 5 Trouble Shooting**

The MID-TECH Legacy 2000 system is constantly monitoring itself, alerting the operator with visual and audible alarms when any abnormality is detected. The following chart presents the error messages that may appear on the display, and possible causes and remedies. If you cannot resolve the problem with these suggestions call MID-TECH Customer Service (1-800-MID-TECH) for assistance.



**FIRST check the battery connections!!**

ERROR MSG.	CAUSE	REMEDY
<b>ERROR</b> AREA BOOM xxx:WIDTH 0	Undefined Boom Width	Using the "Boom set-up" function, enter the width for the boom section indicated.
<b>ERROR</b> SPEED CALIBRATION 0	Speed Calibration # Zero	Re-enter the speed calibration number using the "Speed Set-up Function."
<b>ERROR</b> PRODUCT x CALIBRATION 0	Sensor Calibration Zero	Go to the appropriate "Field Set-up" function for the mode you are using (granular/NH#, Seeder, Spinner) and re-enter the sensor calibration number for the product indicated.
<b>ERROR</b> PRODUCT x DENSITY 0	Density Factor Zero	Go to the Granular/NH3 "Field set-up" function and re-enter the density factor for the product indicated.
<b>ERROR</b> PRODUCT x NO FLOW SIGNAL Sensor Input #1	No Flow Signal  <b>FLOW/GRANULAR/SEEDER CHANNEL</b>  <b>Check for actual operation.</b>  <b><u>No discharge of product/Spinner not running.</u></b>  Main product container is empty.  Leak in main feed line (Liquid).  No output from product pump (liquid).	     Refill Container  Check for ruptures or leaks at joints, fittings, etc.  Turn product pump ON.



<p><b>ERROR</b> PRODUCT x NO FLOW SIGNAL (Cont.)</p>	<p>Obstruction in main supply line (liquid).</p> <p>Boom valves are not opening (liquid).</p> <p>Main flow control valve/ hydraulic valve not opening. (Liquid/Granular/Spinner)</p> <p>Defective PCM module for product indicated. (Liquid/Granular/Spinner)</p> <p><u>Product is being discharged/Spinner is running.</u></p>	<p>Check for correct operation of hydraulic valves feeding the pump motor.</p> <p>Check for air lock in the product pump, causing no output. Purge pump using the PRIME function.</p> <p>Check for blockage in product strainers.</p> <p>Check for blown fuses</p> <p>Check cables from SSM to valves for bad connections, abrasions, and pinched or broken wires.</p> <p>Check cables from PCM to valves for bad connections, abrasions, and pinched or broken wires.</p> <p>Replace defective PCM module.</p> <p>In the case of a flowmeter check for blockage of the flowmeter rotor.</p> <p>Check for damage to sensor.</p> <p>Check cables between sensor and PCM for bad connections, abrasions, and pinched or broken wires.</p>
<p><b>ERROR</b> PRODUCT x NO SENSOR SIGNAL Sensor Input 2</p>	<p>(Secondary Sensor of PCM module for affected product shown on display)</p> <p>Sensor bad</p> <p>Poor Cable Connection</p> <p>Cable to PCM damaged</p>	<p>Replace sensor.</p> <p>Check cable connection between valve and PCM module.</p> <p>Check cables between sensor and PCM for abrasions, and pinched or broken wires.</p>
<p><b>ERROR</b> PRODUCT x SENSOR MISMATCH</p>	<p>The two sensors in a dual sensor arrangement do not agree.</p> <p>Liquid System</p> <p>Granular/Seeder/Spinner</p>	<p>Defective sensor or one sensor partially blocked</p> <p>Bad sensor, motor, or hydraulic pressure on one side.</p>

<p><b>ERROR</b> PRODUCT x OVER APPLICATION</p>	<p>Valve not responding to "Close" signal</p>	<p>Check cable to, and connection with the designated PCM module.  Make sure valve is not sticking.</p>
<p><b>ERROR</b> PRODUCT x UNDER APPLICATION</p>	<p>Valve not responding to "Open" signal</p>	<p>Check cable to, and connection with the designated PCM module.</p>
	<p>Traveling too fast for desired application rate</p>	<p>Slow down, or check hydraulic flow to a hydraulically driven pump.</p>
	<p>Nozzles are too small for rate and speed (Pressure will read high)</p>	<p>Change to larger nozzles or slow down.</p>
	<p>Too much product being diverted to sparge</p>	<p>Reduce sparging or turn up product pump output.</p>
	<p>Strainer or nozzle screens plugged</p>	<p>Clean screens.</p>
<p><b>ERROR</b> PRODUCT x BELOW INJ RANGE</p>	<p>Speed too slow for pump to accurately control.</p>	<p>Increase speed</p>
	<p>If displayed at normal operating speeds this may indicate a bad spot in the pump tubing causing the pump to stall</p>	<p>Inspect tubing and replace if necessary. If replaced, re-calibrate pump before using.</p>
<p><b>ERROR</b> PRODUCT x PUMP RUNNING !!!</p>	<p>Pump Actually Running</p>	<p>unplug the pump power cable at the battery and call for service help.</p>
	<p>Pump not running</p>	<p>check sensor mounting for excessive vibration and sensor wire routing to make sure it is not running near a source of electrical pulses which could cause false rate signals to the pcm.</p>
<p><b>ERROR</b> PRODUCT x CAN VOLTAGE LOW</p>	<p>Bad connection in CAN cable associated with displayed product.</p>	<p>Check all connections between CAN cable segments and CAN "T" connector.</p>
	<p>Defective PSM module (more than 1 module affected)</p>	<p>Replace PCM module.</p>
<p><b>ERROR</b> PRODUCT x BATTERY VOLTAGE</p>	<p>Low Battery Voltage</p>	<p>Check battery connection and fuse for PCM of product being displayed.</p>
<p><b>ERROR</b> PRODUCT x NO COMMUNICATION</p>	<p>Lost Communication With Any Module</p>	<p>Restart System</p>

**Errors**

<b>ERROR</b> PRODUCT x BATTERY GROUND	Battery Ground Fault	Check battery connection of the PCM for the product being displayed.
<b>ERROR</b> LOG DATA FILE ALMOST FULL	Log file Filling Up (Only possible when logging to a PCMCIA card)	Clear data from PCMCIA card .
<b>ERROR</b> LOG DATA FILE IS FULL !!!	Log File Full (Only possible when logging to a PCMCIA card)	Clear data from PCMCIA card.

## Chapter 6 Emergency Operations

**M**IDWEST TECHNOLOGIES has gone to great lengths to make the Legacy 2000 System as foolproof and reliable as possible. However, problems may still occur from time to time. If the operator does experience a failure of the ground speed sensor, the main flow control valve, the flow meter, or rate sensor, first carefully check any associated CAN Bus cables, "T" connectors, and control module to controlled unit wiring for obvious breaks, abrasions, or loose connections. Follow the suggested troubleshooting advice outlined in Chapter 5 in this manual. Assuming there is no success in attempts to get the failed component to respond, MIDWEST TECHNOLOGIES suggests the following procedures, **as a temporary measure**, until the component can be fixed or replaced.

**If the operator chooses to follow one of the following procedures, he should recognize that the accuracy of application is reduced. If this reduced accuracy is acceptable, these procedures allow the operator to continue on a temporary basis.**

### GROUND SPEED SENSOR FAILURE

**I**f the Ground Speed Sensor fails, a GPS equipped machine can continue normal application by enabling the GPS speed input to the Legacy system as described on page 4-25.

Another "temporary fix" is using the "Manual Speed" function for the speed input as described on page 3-4. When the unit is operated in this manner, the Legacy system establishes the application rate as if the vehicle were actually moving across the field at the programmed Manual Speed. **Consequently the application accuracy will depend on the ability of the operator to drive at the programed speed.**

**MIDWEST TECHNOLOGIES RECOMMENDS THIS PROCEDURE ONLY AS A TEMPORARY, EMERGENCY PROCEDURE. THE PROBLEM WITH THE GROUND SPEED SENSOR SHOULD BE RESOLVED AS SOON AS PRACTICAL SO THAT FULL CONTROL OF THE APPLICATOR CAN AGAIN BE ENJOYED.**



## **FLOW CONTROL VALVE FAILURE**

(Liquid Applicator)

**T**he Legacy system can be operated **at a reduced level of accuracy** in the event of a flow control valve failure. To operate the sprayer, it is necessary to manually adjust the flow control valve to provide sufficient pressure to the booms to provide a good spray pattern. Thus, there is no longer automatic control of the flow. Use the following procedure to manually position the flow control valve.

**A. With the vehicle stopped, turn OFF all boom sections.**

**B. Disconnect the valve from the PCM. If the valve has failed in an open position, allowing sufficient flow to provide a good spray pattern, no further action is needed to adjust the valve. If the valve has failed in a closed or nearly closed position, it is necessary to remove the electric actuator assembly and manually rotate the valve stem to an open position. CAUTION. FIRST MARK THE VALVE POSITION. TYPICALLY FULL OPEN TO FULL CLOSE IS ONLY A 90° ROTATION. For machines that use Mid-Tech's EXR II hydraulic control valve to regulate the pump speed, loosen the locking collar at the base of the actuator, and rotate the complete actuator until the desired boom pressure is achieved. Retighten the locking collar.**



**C. Turn ON the normal boom sections. Use a nozzle chart to determine the boom pressure that will give the desired APPLICATION RATE at the target speed. Adjust the pump bypass valve (if one is provided) or manually turn the control valve stem to generate the desired boom pressure. Turn all boom sections OFF.**

**D. At this point, the operator can monitor functions, such as speed, application rate, and area but has no automatic control of the flow control valve.**

**E. Monitor the Application Rate and adjust the ground speed to maintain the desired rate.**

**F. The console cannot automatically adjust for**

changes in boom widths. If booms sections are turned on or off, the pressure must be readjusted manually.









**MIDWEST TECHNOLOGIES RECOMMENDS THIS PROCEDURE ONLY AS A TEMPORARY, EMERGENCY PROCEDURE. THE PROBLEM WITH THE FLOW CONTROL VALVE SHOULD BE RESOLVED AS SOON AS PRACTICAL SO THAT FULL CONTROL OF THE SPRAYER CAN AGAIN BE ENJOYED.**

### **FLOWMETER/PRESSURE SENSOR FAILURE**

(Liquid Applicator)

The procedure is very similar to operating with a defective flow control valve except, in this instance, the flow control valve is cycled using the Manual Rate Control function.

- A. Turn OFF all boom sections and stop the vehicle. Disconnect the flowmeter from the PCM.**
- B. Enter the Manual Rate Control function as described on page 3.2. The Flow Control Valve will now respond only to OPEN/CLOSE commands from the  and  buttons on the Legacy console.**
- C. Turn ON the normal boom sections and allow spray. Use a nozzle chart to determine the boom pressure that will give the desired APPLICATION RATE at the target speed. Adjust the boom pressure using the  and  buttons. Once the desired pressure is attained, turn all boom sections OFF.**
- D. At this point, the operator can monitor functions such as speed and area but has no automatic control of the flow control valve.**
- E. Adjust the ground speed to maintain the target speed desired.**
- F. The console cannot automatically adjust for changes in boom widths. If booms sections are turned on or off, the pressure must be readjusted using the  and  buttons.**





**MIDWEST TECHNOLOGIES RECOMMENDS THIS PROCEDURE ONLY AS AN EMERGENCY, TEMPORARY PROCEDURE. THE PROBLEM WITH THE FLOW METER OR PRESSURE SENSOR SHOULD BE RESOLVED AS SOON AS PRACTICAL SO THAT FULL CONTROL OF THE SPRAYER CAN AGAIN BE ENJOYED.**

**APPLICATION RATE SENSOR FAILURE**

(GRANULAR APPLICATION)

The Legacy spreader system, suffering a rate sensor failure, can be operated in a manner similar to the previously described sprayer failure.

**A. Turn the Conveyor Switch OFF and stop the vehicle. Disconnect the rate sensor from the PCM.**

**B. Enter the Manual Rate Control function as described on page 3.2. The Hydraulic Flow Control Valve now responds only to OPEN/CLOSE commands from the ▲ and ▼ buttons on the Legacy console.**

**C. At this point, the operator can monitor the speed and area but has no automatic control of the hydraulic flow control valve. NOTE: On some systems, the hydraulic control valve is used to turn the spreader on and off. If this is the case, it is necessary to use the ▲ and ▼ buttons to start and stop the spreader conveyor.**

**D. Adjust the ground speed to reach the target rate desired.**



**MIDWEST TECHNOLOGIES RECOMMENDS THIS PROCEDURE ONLY AS AN EMERGENCY, TEMPORARY PROCEDURE. THE PROBLEM WITH THE RATE SENSOR SHOULD BE RESOLVED AS SOON AS PRACTICAL SO THAT FULL CONTROL OF THE SPREADER CAN AGAIN BE ENJOYED.**



# *Appendix A*

## *System Diagram*



SAMPLE SYSTEM DIAGRAM

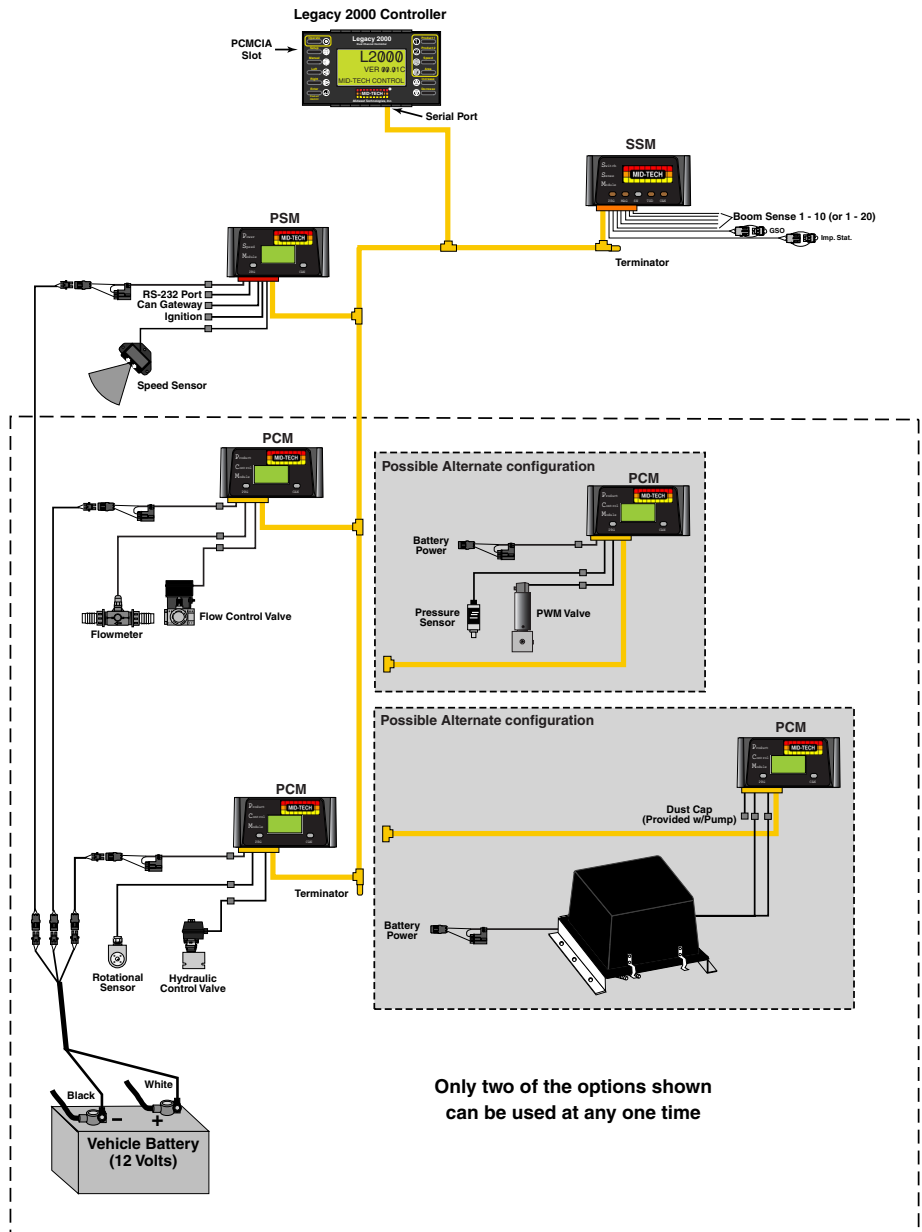

# *Appendix B*

## *System Overview*



## System Components

### MODULES

There are several basic components that make up the Legacy 2000 Control System. These components are designed to work with most existing valves, sensors, motors, etc. providing an easy to use, more versatile, easier to install and upgrade system.

A sample system diagram is shown on page A-2. Several possible combinations are shown but, since the Legacy is a two channel system, only two of the configurations shown can be used at any one time.

The “Legacy Console” (Fig. B-1) is the ‘Human Interface’ with the system. The operator enters all

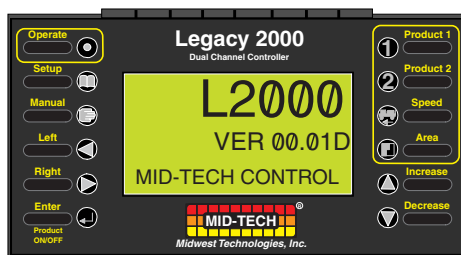

Fig. B-1 - Legacy 2000 Console

system configuration information and application requirements into the console. In return the console keeps the operator informed of the system and application status. Ports are also provided to connect to a task computer for GPS control and to other CAN Bus systems allowing the exchange of certain information.

Unlike most application systems the Legacy console does not do all of the “thinking” for the system. Each remote module has a microprocessor to help it perform its specific duties. This allows for a faster response to a change in conditions. At frequent intervals the modules report status back to the console and check for any change in orders.

The “Power Speed Module” (PSM) (Fig. B-2) monitors

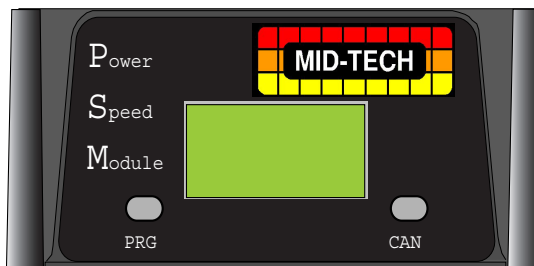

Fig. B-2 Power Speed Module

the ignition switch to know when the machine is turned on, controls the system start-up sequence, provides power to the CAN Bus system, processes the input signal from an external speed sensor, and monitors the CAN voltage.

The “Switch Sense Module” (SSM) (Fig. B-3) monitors up to 20 Boom sense lines and provides for input from a Ground speed Override (GSO) or Implement Status switch.

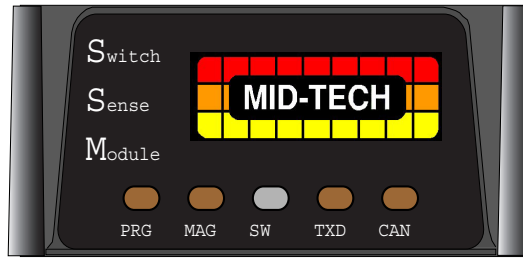

Fig. B-3 Switch sense Module

The “Product Control Module (PCM) (Fig. B-4) is the direct interace with the valves, pumps, sensors, etc. that are doing the physical controlling of the application. The flexibility of this module allows it to control servo and PWM valves and DC motors. It can monitor up to three sensors per product including pressure sensors, flowmeters, and granular sensors.

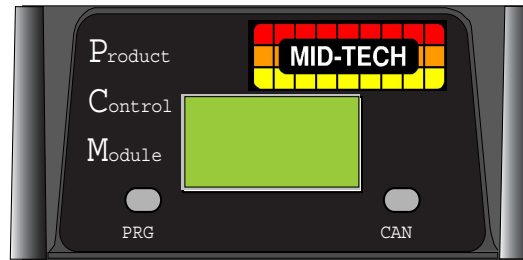
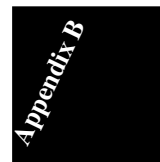

Fig. B-4 Product control Module

Each module is constantly monitoring its portion of the system status, such as CAN voltage, application rate, switch status, etc. and reporting back to the console for display to the operator. Most of the modules have displays which provide information that may be helpful when working with Customer Service on some problems which may arise.

Changing product types may only require a quick change of system settings. Adding or changing a module is “Plug and Play”. Module set-up information is stored in the console as well as the module so, if a module is changed out, the previous set-up information can be downloaded to the new module without going through the set-up routine again.

The system is tied together with the CAN Bus cable. To add a module to the system, just insert a CAN “T” connector between cable sections and plug in the new module.



**CABLES AND HARNESSES**

A variety of cables and harnesses are available for the Legacy system to connect the various modules to the main CAN cable and to make the system compatible with a wide range of existing equipment. Several of these cables are shown in the system diagram in Appendix A. The boot on each cable is color coded to match the label on the type of module it is used with. Following are the cables associated with the various types of modules.

**LEGACY 2000 CONSOLE**



**Legacy 2000 cable options**

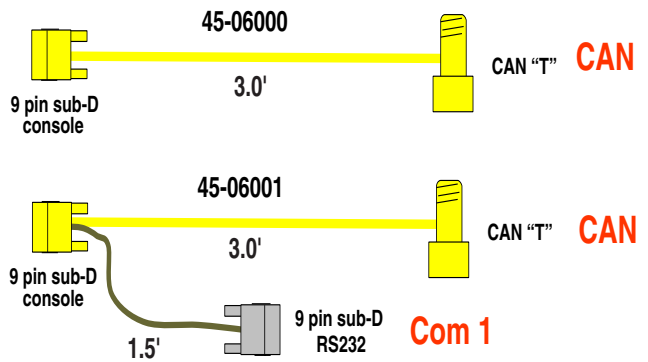

**POWER SPEED MODULE**

**PSM Harness**

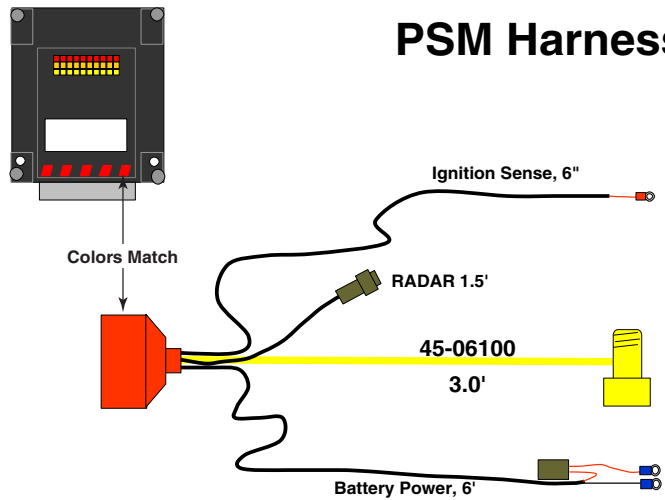

SWITCH SENSE MODULE

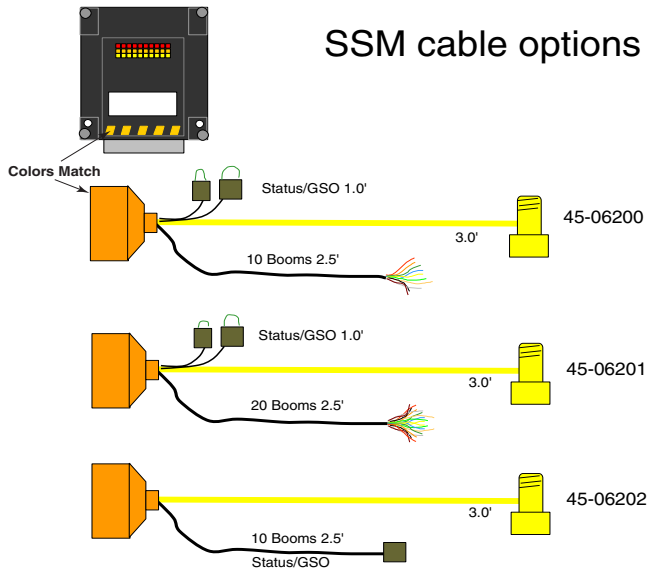

PRODUCT CONTROL MODULE

PCM Cable Options

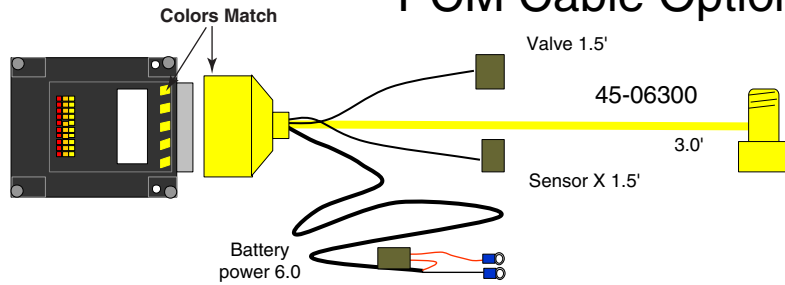

P/N	A	B	C	D	E	F	CAN	PWR	Valve	Snsor	Description
45-06300	X						X	X	X	1	Single sensor
45-06301	X			X			X	X	X	2	Single sensor w/rpm
45-06302	X	X		X			X	X	X	3	Dual sensor w/rpm
45-06303	X					X	X	X	X	2	Single sensor w/press
45-06304					X		X	X	X	1	Pressure control, single
45-06305					X	X	X	X	X	2	pressure control, dual

Appendix B

## CAN EXTENSION CABLES

The CAN Extension Cables serve as the main “Backbone” cable for the Legacy system, tying the individual modules together. The cables come in three, six and twelve foot lengths.

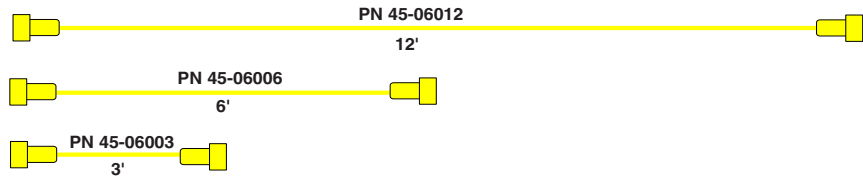



# *Appendix C*

## *Glossary/Tables*



**GLOSSARY**

The definitions in this glossary are worded to fit the needs of this manual only and may not apply to all operations in general.

**AutoRange® Valve** - A three port valve which controls both the main liquid flow and bypass flow.

**Boom** - An application width that is assigned a value and is used to calculate area.

**Boom Section** - Part of a boom that can be turned on or off independent of other boom sections.

**Bypass** - The process of routing excess product pump output back to the low pressure side of the pump to control the amount of product available to the spray booms for application. This process is also used in hydraulic flow control also.

**CAN** - (Controller Area Network) - A control system that incorporates a single "Bus" cable, rather than several individual cables, to communicate with the other components of the system.

**Carrier** - A liquid or dry material that is used to convey herbicide, insecticide, fungicide, micronutrients, etc., to the ground.

**Chemical Flow Monitor** - A console mounted near the operator, which monitors up to six injection pumps, and initiates an alarm condition when the control system is calling for product from a certain injection pump but that pump's chemical flow sensor detects no flow. This console is also used in some granular applications to monitor the product level in granular application bins.

**Chemical Flow Sensor** - Monitors the output of an injection pump and sends a signal to the chemical flow monitor if there is no output from the pump.

**Chemical Injection System** - A system that includes a control console and a chemical injection pump. This system is designed to control chemical at a target rate, normally into a carrier product.

**Console** - An operator interface which allows the operator to set and monitor all application conditions, such as speed, swath width, and current product flow rate, etc., and sends the necessary information on the bus cable so the system can maintain the application rate at that designated by the operator.

**Electromagnetic Interference** - Externally generated electromagnetic fields, such as those from a high voltage transmission line, a vehicle alternator with a bad diode, sparkplugs, etc., which can disrupt the normal operation of an electronic device.

**Flow Control System** - A system that includes a control console, a rate sensor device, and a valve to control product flow. This system is designed to control product to a target rate.

**Flowmeter** - A device which measures volumetric liquid flow.

**Standard Flowmeter** - Each standard flowmeter has a standard range that it can accurately measure. To change ranges requires changing flowmeters.

**Rapid Check Flowmeter** - Similar to a standard flowmeter but has several different “inserts”, each with a different effective range, that can be installed. Changing the range of the flowmeter only requires removing one insert and inserting one having the desired flow range.

**GSO** - Ground Speed Override is a minimum application speed function. When the vehicle speed drops below the selected GSO speed, the system controls application to the GSO speed. Area is accumulated at the actual ground speed.

**Hydraulic Servo Control Valve** – The term used to describe a control valve that is capable of receiving and acting upon open and close commands from the system and in turn controls the flow of hydraulic fluid.

**Impeller** - A metallic device, similar to a propeller, used in a flowmeter to monitor the liquid flow.

Liquid flowing past the impeller causes it to turn. A magnet sensor, placed near the flowmeter wall, senses the impeller blades as they pass and generates pulses to be sent to the control console.

**Implement Status Switch** - Provides another way to stop the application. This switch may take the form of a foot switch or an implement switch mounted on the tool bar that opens a circuit as the tool bar is raised, effectively stopping the application.

**Liquid Flow Control Valve** – A valve, controlled by open and close commands from the system, that in turn controls the flow of liquid product.

**Master switch** - A control switch that allows the operator to turn on and off all active booms with one switch.

**Max Duty Cycle** - Maximum controllable Duty Cycle - Usable range provided by valve or machine supplier. Set to 98 for electric motor drive.

**Min Duty Cycle** - The starting drive from a valve closed condition. Same as start drive for an electric motor. The system can operate below this level after initial control has been achieved. Provided by PWM Valve or machine supplier.

**PCM** - (Product Control Module) - A microprocessor controlled module that interfaces between the console of the MID-TECH CAN system and units such as valves, sensors, pumps, etc..

**PSM** - (Power/Speed Module) - A microprocessor controlled module that monitors the signal from a speed sensor such as a radar unit, provides power to the CAN bus, and controls the powering up and down of the MID-TECH CAN system.

**PCMCIA Memory Card** - a unit which can be plugged into a computer device having a "PCMCIA Slot". The card acts as an additional storage drive. In the Legacy 2000 the cards contain the necessary programs and can be used to store information .

**Product** – Refers to the material that is to be metered and controlled by the system. This material can be grouped into the following categories:

**Liquid** – Includes, but is not limited to, liquid fertilizer, liquid fertilizer with chemical, water, water with chemical, liquid lime, deicing solutions, salt solutions, liquid manure, etc.

**Chemical** – Includes, but is not limited to, herbicide, liquid fertilizer, spray adjuvants, fungicides, insecticide, etc.

**Granular** - Includes, but is not limited to lime, dry fertilizer, phosphate, and DAP.

**NH<sub>3</sub>** - (Anhydrous Ammonia) A fertilizer material that is condensed from a gas to a liquid in order to be metered. Density of this material is entered into the equation in order for pounds of Nitrogen to be targeted and recorded.

**Seed** - Includes, but is not limited to, corn and beans.

**Peristaltic Injection Pump** - A pump in which a piece of tubing (see Pump Tube) inserted into the pump is squeezed between the inside wall of the pump and rollers attached to a rotating plate. Since the rollers are evenly spaced on the plate, the amount of material trapped between the rollers is always consistent. By knowing how many revolutions the pump rotor has made, the volume of liquid discharged by the pump can be calculated quite precisely .

**Pump Control Module**- An electronic module, located inside the injection pump enclosure, which controls the various pump functions as required by the PCM.

**Pump Tube** - A length of tubing, usually Python or ED-Plex type, used in a peristaltic type injection pump.

**PWM - Pulse Width Modulation.** A method used to electrically control the position of a valve or the speed of a motor by adjusting the duty cycle of the control signal.

Appendix C

**PWM Dither %** - Used to fine tune a “sticky” PWM valve. Do not change without recommendation of MID-TECH customer service. Set to 0 for electric motor drive.

**PWM Frequency** - Provided by PWM Valve or machine supplier.

**Ramp Time** - How fast a PWM valve, or electric motor drive, reacts when the application is off target. The longer the time, the slower the valve will be to react to changes.

**Returned Material Authorization Number (RMA) -**

A number obtained from MID-TECH through your dealer, which serves as your approval to return an item and informs MID-TECH of the circumstances of the return so that proper action (repair, replacement, credit, etc.) can be initiated quickly upon receipt of the item at MID-TECH.

**SSM - (Switch Sense Module)** - A microprocessor controlled module that monitors the status of boom and conveyor control lines and Implement status and GSO switches and passes this information to the console of the MID-TECH CAN system.

**Startup Drive Duty Cycle** - The amount of drive signal which initially opens the valve from a dead closed position until sensor response is achieved and stabilized.

**Swath** – A boom section or group of boom sections that accumulates area as a group.

**Spurge** - The process of routing excess product pump output back to the product tank to be used for agitation keeping dissolved products in suspension.

**Terminator** - A plug which must be placed at any open end of a CAN Bus cable to make the cable electrically balanced.

**Valve Hold Delay Time** - The amount of time the valve waits, after coming out of a HOLD or CLOSE condition, before resuming automatic control.

**Valve Speed Value** - How fast a servo valve reacts when the application is off target. The bigger the number the faster the valve will move. Does not function when in PWM drive, see ramp time.

Appendix C

USEFUL FORMULAS

$$\text{Noz. Press.} = \left[ \frac{(\text{Rate} \times \text{Speed} \times \text{Noz. Spacing})}{(\text{GPM}_{40} \times 939.2)} \right]^2$$

Where: Rate = GPA  
 Speed = MPH  
 Noz. Spacing = Inches  
 GPM<sub>40</sub> = Noz. Flow @ 40 PSI

$$\text{GSO}_{p. \text{ Min}} = \frac{[\text{GPM}_{40} \times 939.2 \times \sqrt{P_{\text{Min}}}]}{(\text{Noz. Spacing} \times \text{GPA})}$$

$$\text{Where: GSO}_{(10 \text{ PSI})} = \frac{(\text{GPM}_{40} \times 2970)}{(\text{Noz. Spacing} \times \text{Rate})}$$

$$\text{GSO}_{(15 \text{ PSI})} = \frac{(\text{GPM}_{40} \times 3637.5)}{(\text{Noz. Spacing} \times \text{Rate})}$$

GSO = Speed to Maintain a Min. Press (P<sub>Min</sub>)  
 Rate = GPA  
 Noz. Spacing = Inches  
 GPM<sub>40</sub> = Noz. Flow @ 40 PSI

$$\text{Gal/MinBoom} = \frac{(\text{Rate} \times \text{Speed} \times \text{Boom Width})}{495}$$

Where: Rate = GPA  
 Speed = MPH  
 Boom Width = Ft.

$$\text{Gal/MinNoz} = \frac{(\text{Rate} \times \text{Speed} \times \text{Noz. Spacing})}{5940}$$

Where: Rate = GPA  
 Speed = MPH  
 Noz. Spacing = Inches



ENGLISH/METRIC CONVERSION

**U.S. to Metric**

1 Acre = 0.405 Hectares  
1 mile = 1.61 Kilometers  
1 Foot = 0.305 Meters  
1 Inch = 2.54 Centimeters  
1 US Gallon = 3.785 Liters  
1 Fluid Ounce = 29.57 Milliliters  
1 pound = 0.454 Kilogram  
1 Cubic Foot (ft<sup>3</sup>) = 0.028 Cubic Meters (M<sup>3</sup>)  
1 Pound per Gallon = 119.68 Grams per Liter  
1 US Gallon per Acre = 9.35 Liters per Hectare

**Metric to U.S.**

1 Hectare = 2.471 Acres  
1 Kilometer = .62 Miles  
1 Meter = 3.28 Feet  
1 Centimeter = 0.394 Inches  
1 Liter = 0.2642 Gallons  
1 Milliliter = 0.034 - Fluid Ounces  
1 Kilogram = 2.205 Pounds  
1 Cubic Meter = 35.31 Cubic Feet  
1 Kilogram per Liter = 8.36 Pounds per Gallon  
1 Liter per Hectare = 0.107 Gallons per Acre

Appendix C



<b>NH<sub>3</sub> DENSITY TABLE</b>
-------------------------------------

## ANHYDROUS OPERATION

### (NH<sub>3</sub> Procedures)

### Special Considerations

**SENSOR CALIBRATION:** The sensor calibration will be the number of sensor pulses per gallon of Nitrogen discharged. This will vary slightly with temperature. Use the following chart to choose the correct density for calculating the calibration number. Use the pounds per gallon number as your density in the Legacy console.

#### DENSITY TABLE

NURSE TANK TEMPERATURE °F	NURSE TANK PRESSURE (PSI)	POUNDS OF NITROGEN PER GALLON
-28	0	4.68
-8	10	4.59
6	20	4.52
16	30	4.46
26	40	4.42
34	50	4.38
42	60	4.33
50	75	4.29
58	90	4.25
68	110	4.20
77	130	4.14
86	155	4.09
96	185	4.04
105	215	3.97
115	250	3.92

For MID-TECH flow meters calibrated in pulses per gallon, use the following formula:

$$\text{Cal\#}_{(\text{pounds of N})} = (\text{flow meter cal\#})$$

For RAVEN flow meters calibrated in pulses per 10 gallons, use the following formula:

$$\text{Cal\#}_{(\text{pounds of N})} = (0.1 \times \text{flow meter cal\#})$$

For DICKEY-john flow meters calibrated in pulses per cubic inch, use the following formula:

$$\text{Cal\#}_{(\text{pounds of N})} = (\text{flow meter cal\#} \times 231)$$

Appendix C

This page left blank intentionally

# *Index*

**INDEX**

**A**

active boom sections 4-29  
Adding or changing a module B-3  
ALERT Screens 4-23  
Amount Collected 4-13  
Amount Displayed 4-13  
Area Monitoring. *See* Monitoring: Area  
Area Reset 3-6

**B**

Baud Rate 4-25  
Boom Assignment 4-30  
Boom sense lines B-3  
Boom Setup 4-29  
Boom Width 4-29

**C**

Calibrate Function 4-13  
Calibration 1-2  
Calibration Numbers C-10  
CAN Bus cable B-3  
CAN Bus system B-2  
CAN "T" connector B-3  
CAUTION 3-3, 3-6  
Clear the accumulator 4-14  
COM 1 3-7, 4-24, 4-25  
COM 2 3-7, 4-24, 4-25  
COM Ports 4-22, 4-25  
Components 1-2  
Console 2-1, 4-23  
Console control buttons 1-1  
Control modules 1-1  
Conversion Factor 4-5

**D**

Data Logging 3-7  
Density 4-6

**E**

Emergency Operation  
Application Rate sensor Failure 6-4

Flow Control Valve Failure 6-2  
Flowmeter/Pressure sensor Failure 6-3  
Ground Speed Sensor Failure 6-1  
English/Metric Conversion C-8  
Entering The Operate Mode 3-1  
Error Messages  
LOG DATA FILE IS FULL !!! 5-4  
LOG DATAFILE ALMOST FULL 5-4  
PRODUCT x BATTERY GROUND 5-4  
PRODUCT x BELOW INJ RANGE 5-3  
PRODUCT x CAN VOLTAGE LOW 5-3  
PRODUCT x NO COMMUNICATION 5-3  
PRODUCT x NO SENSOR SIGNAL 5-2  
PRODUCT x OVER APPLICATION 5-3  
PRODUCT x PUMP RUNNING !!! 5-3  
PRODUCT x SENSOR MISMATCH 5-2  
PRODUCT x UNDER APPLICATION 5-3  
PRODUCT x BATTERY VOLTAGE 5-3  
PRODUCT x CALIBRATION 0 5-1  
PRODUCT xDENSITY 0 5-1  
PRODUCT xNO FLOW SIGNAL 5-1  
SPEED CALIBRATION 0 5-1  
WIDTH BOOM xxx:WIDTH 0 5-1  
error messages 1-2  
Event Logging 4-24

**F**

Field Set-up 4-1  
flashing digit 4-2, 4-6, 4-7, 4-9, 4-10, 4-11  
Flowmeter Cal. # Set 4-3

**G**

Glossary C-2  
 GPS OFF 4-31  
 GPS ON 4-31  
 GPS Speed Setup 4-31  
 Granular/NH3 Set-up 4-6  
 Ground Speed Override 4-29  
 Ground speed Override B-3  
 GSO 4-29, B-3  
 GSO Setup 4-29

**H**

Hardware Test 4-26  
 High Pressure Reference Point 4-4

**I**

Illustrations. *See* Screens  
 Implement Status B-3  
 Initial Calibration Number 4-3  
 Initial Spreader Constant 4-7  
 Injection Drive Setup 4-21  
 Injection Prime/Calibrate Function 4-11  
 Injection pump 4-11  
 Introduction 1-1

**L**

Legacy Console B-2  
 Liquid Mode Set-up 4-2  
 Log Destination 4-24

**M**

Machine Set-up 4-14  
 Magnet 4-12, 4-13  
 Manual Mode. *See* Manual Rate Control  
 Manual pressure gauge 4-4  
 Manual Rate Control 3-2  
 Manual Speed 3-4  
 Max Duty Cycle 4-20  
 Measured calibration distance 4-28  
 Min. Duty Cycle 4-20  
 Miscellaneous Notes C-10  
 Mitch 1-1  
 Monitoring  
   Area 3-5  
   Product 3-1

MT PROTO 4-25

**N**

New Cal. # 4-2, 4-4, 4-8, 4-10  
 NMEA 183 4-25  
 Nozzle Constant 4-4  
 Number Of Swaths 4-30

**O**

On-line/Off-line status 4-23  
 Operate 3-1  
 Operate Mode 3-1

**P**

PCM 4-12, 4-13, 4-23, B-3  
 Port communication speed 4-25  
 Power Speed Module B-2  
 Pre-selected Rates 3-2  
 Preset Application Rates 4-2  
 preventing equipment damage 1-1  
 Prime Function 4-12  
 Product Application Modes 4-1  
 Product Area accumulator 3-6  
 Product Control 3-2  
 Product Control Module B-3  
 Product Linking 4-21  
 Product Modes 4-14  
 Product Monitoring. *See* Monitoring:  
   Product  
 PSM 2-1, 4-23, B-2  
 Pulses/Gallon 4-3, 4-7, 4-9  
 Pulses/Liter 4-3, 4-7, 4-9  
 PWM % Dithe 4-20  
 PWM Valve Set-up 4-20

**R**

Resetting accumulators 3-3  
 RESUM 4-18  
 RPM 4-19

**S**

safety 1-1  
 Screens  
   Active boom sections 4-29



Active Swaths 4-30  
Area clear all 3-6  
Area Display 3-5  
Area Reset Screen 3-6  
Boom Widths 4-28  
Boom/Swath Assignment 4-30  
Booms OFF Valve Response 4-17  
Button Test Screen 4-26  
Cal Function Selected 4-13  
Cal. Volume correction 4-12  
Change Units Screen 4-22  
Clear Alert 3-3  
COM Port Mode Screen 4-25  
COM Port Speed Select Screen 4-25  
Cycling 4-1  
Density Set 4-7  
Display segment Test 4-27  
Event Select Screen 4-25  
Flowmeter Cal. # Set 4-3  
GPS Setup Screen 4-30  
GSO Setup 4-29  
Key Beep Screen 4-23  
Log Destination Screen 4-25  
Logging Control 3-7  
Main Setup 4-1  
Manual Mode 3-3  
Operate Button Test 4-27  
PCM Magnet Placement 4-12  
Prime Function Selected 4-8, 4-13  
Prime Volume 4-13  
Prime/Cal Select 4-12  
Product 1 Linked to Product 2 4-20  
Product Accumulating 4-10, 4-13  
Product Linking 4-20  
Product select screen 4-15  
Product Status OFF 3-1  
Product Status ON 3-1  
PSI Zero Point Set 4-3  
Pump Cal. Run 4-13  
Pump Prime 4-13  
PWM % Dither Set-up 4-20  
PWM Frequency Set-up 4-20, 4-21  
PWM Max Duty cycle Set-up 4-21  
PWM Ramp Time Set-up 4-20  
Reset Alert Screen 4-27  
RPM Set-up Screen 4-19  
Select Logging Event 4-24  
Set Cal. # 4-7  
Set Time and Date 4-26  
Setting preset Rates 4-2, 4-6  
Setting the conversion Factor 4-4  
Setting the Nozzle Constant 4-4  
Show Modules Screen 4-22  
Speed Cal. End 4-28, 4-29  
Speed Cal. Screen 4-28  
Speed Cal. Start 4-28  
Speed Setup Screen 4-28  
Speed/Distance 3-4  
Start Up Duty Cycle 4-19  
Starting Logging 3-7  
Status switch OFF Valve Response 4-17  
Stopping Logging 3-7  
Swath Assignment 4-19  
Swaths Assigned 4-19  
Swaths Available 4-19  
System Check 2-1  
System Ready 2-1  
System Setup Screens 4-22  
Third Line Display 3-2  
Time Logging Screen 4-24  
Total Applied 3-2  
Unit Alert Screen 4-23  
Units Select Screen 4-15  
Valve Speed Select 4-16  
Valve Start Up Delay Set-up 4-19  
Valve/Drive Select Screen 4-17  
Seeder Set-up 4-8  
Serial Numbers 4-23  
Servo Valve Setup 4-16  
Setup 4-1  
Show Modules 4-23  
Software Reset 4-26  
Software Versions 4-23  
Specific gravity 4-5  
Speed and Distance Monitoring 3-4  
Speed Calibration 4-28  
Speed Calibration number 4-28  
Spinner Mode Set-up 4-10  
SRAM Card 1-1, 3-7, 4-24  
SSM 4-23, B-3  
Start Up Drive % Duty Cycle 4-18  
Start-up 2-1  
Start-up Sequence 2-1





start-up sequence B-2  
Status Switch 4-16, 4-21  
Swath 4-30  
Swath Setup 4-30  
Switch Sense Module B-3  
Symbols  
    Icons 1-1  
    Mitch 1-1  
System Check 2-1  
System Components B-2  
System Diagram A-2  
System Overview B-1  
System Restart 4-27  
System Setup 4-22  
System tests 4-22  
System Units 4-22

## **T**

### Tables

    4-1 - Product Modes 4-15  
    4-2 - Units of Measure 4-15  
    4-3 Valve/Driver Types 4-16  
task computer B-2  
Time & date 4-22  
Time Logging 4-24  
Total Area Accumulation 3-5  
Total Distance accumulator 3-4

## **U**

Units of Measure 4-23  
Useful Formulas C-9

## **V**

Valve Speed Selec 4-21

## **W**

WARNING 4-22, 4-27

## **Z**

Zero Pressure Reference Poin 4-3  
Zero Set Point 4-3

This page left blank intentionally

## QUICK START REFERENCE

The following items should be checked before starting each days operation. (For detailed information, or if this is the initial setup for the machine, see Chapter 3.)

- 1. Preset Application Rates -----Page 3-2
- 2. Clear accumulators
  - A. Total Applied Accumulators -----Page 3-3
  - B. Total Distance Accumulator ----- Page 3-4
  - C. Area Accumulators ----- Page 3-6
- 3. Data Logging - ON/OFF ----- Page 3-7

## QUICK SET UP REFERENCE

- 1. Select U.S./Metric Units ----- Page 4-22
- 2. Set Date & Time -----Page 4-27
- 3. Console Calibration Numbers
  - A. Speed Cal. -----Page 4-28
  - B. Flow Sensor Cal. - (Liquid) ----- Page 4-3
    - (Granular/NH<sub>3</sub>) ----- Page 4-6
    - (Seeder) ----- Page 4-9
    - (Spinner) ----- Page 4-11
    - (Injection) ----- Page 4-13
  - C. Boom Set-up -----Page 4-29
- 4. Product Mode Set-up ----- Page 4-14
- 5. GSO Speed -----Page 4-29
- 6. GPS Speed -----Page 4-31
- 7. Manual Speed ----- Page 3-4
- 8. COM Ports ----- Page 4-25

# MIDWEST TECHNOLOGIES, LLC

*Specialists in Control System Electronics Since 1983*



**Contact your Mid-Tech dealer to see our  
complete line of accessories for your  
application**

### ***Corporate Office***

2733 East Ash Street  
Springfield, IL 62703  
Phone: 217.753.8424 Fax:  
217.753.8426

### ***Sales and Service***

[www.mid-tech.com](http://www.mid-tech.com)  
1.800.MID.TECH  
(1.800.643.8324)

### ***Montana Office***

90 West Central Avenue  
Belgrade, MT 59714  
Phone: 406.388.1993 Fax:  
406.388.1883