

# AEROS 9040

U S E R   G U I D E

Software version 4.32



**TeeJet**<sup>®</sup>  
TECHNOLOGIES

A Subsidiary of  **Spraying Systems Co.**<sup>®</sup>

# Table of Contents

## START SIMPLE GUIDANCE

1

### #1 POWER ON

1

### #2 HOME SCREEN

1

System Setup .....	1
RealView Camera Full Screen Video View .....	1
ISOBUS Universal Terminal View .....	1
Simple or Advanced Mode .....	1

### #3 GO TO CONFIGURATION

2

1) Set Up the Local Cultural Settings .....	2
2) Set Up the GNSS .....	2
3) Set Up the Implement .....	3
Implement Settings per Equipment Present .....	3
Single Section Setup .....	3
Section(s) with ISOBUS Sprayer/Spreader Setup .....	4
Additional Settings per Implement Type .....	4
Section Numbers .....	5
Straight .....	5
Spreader – TeeJet .....	6
Lateral Implement Offset Distance Adjustment .....	7
GNSS Offset Adjustment Calculation .....	7
Lateral Implement Offset Adjustment .....	8
4) Set Up the Mapping Location .....	9

### #4 START NEW JOB OR CONTINUE JOB

10

Simple Mode .....	10
Advanced Mode .....	10

### #5 SET UP GUIDANCE

11

1) Choose a Guidance Mode .....	11
2) Establish an AB guideline .....	12
3) Create an Application Boundary .....	12

## ADD RATE CONTROL

14

Guidance Screen Options .....	14
-------------------------------	----



### MAPPING OPTIONS

15

Duplicating and Transferring Maps .....	15
Coverage Map .....	16
Polygons Map .....	16
Prescription Map .....	16
Application and Target Rate Maps .....	17
Target Rates .....	17
Color Range Selection .....	17

## INFORMATION ON GUIDANCE MODES

18

Vehicle View.....	18
Field View.....	18
RealView Guidance .....	19



## GUIDANCE MODES

19

Straight AB Guidance.....	19
Curved AB Guidance .....	19
Adaptive Curve AB Guidance .....	19
Circle Pivot Guidance .....	20
Last Pass Guidance.....	20
NextRow Guidance .....	20
No Guidance.....	20

## SCREENS OPTIONS

21

## GUIDANCE BAR

25

## STATUS BAR

26

## GUIDANCE FEATURES DETAILS

27

A+ Nudge Feature .....	27
Azimuth Degree.....	27
Return to Point.....	28
Next Guideline Feature.....	29



## REFRESH GNSS POSITION

29



## BOOMPILOT

30

No Section Control Module .....	30
ISOBUS Sprayer.....	30
ISOBUS Spreader.....	31
With TeeJet Section Control Module And Switchbox or ISM .....	32
With TeeJet Section Control Module .....	32

## ADDITIONAL IMPLEMENT OPTIONS

33

### TIP SELECTION

33

Preset.....	33
<i>Tip Sizes and Associated Colors.....</i>	33
Current Tip.....	34

### DROPLET SIZE MONITOR

34

Setup.....	34
Enable/Disable DSM .....	34
Tip Selection / Current Tip.....	34
Input/Output Module Pressure Sensor.....	34

# Aeros 9040 Field Computer

---

Operation .....	35
Status Bar .....	35
<i>Droplet Size Chart</i> .....	35
Guidance Bar .....	35

<b>REVERSE SENSE</b> .....	<b>36</b>
----------------------------	-----------

<b>BOOMPILOT SECTION CONTROL</b> .....	<b>37</b>
--	-----------

<b>TIP FLOW MONITOR</b> .....	<b>38</b>
-------------------------------	-----------

<b>ISOBUS SPRAYER OFFSETS</b> .....	<b>38</b>
-------------------------------------	-----------

Self-propelled .....	39
Three Point Hitch .....	39
Trailed .....	40

<b>DATA MANAGEMENT</b> .....	<b>41</b>
------------------------------	-----------

---

Job Data .....	42
<i>Copy Job Data</i> .....	42
Machine Settings .....	43
<i>Copy Machine Profile</i> .....	43

<b>SYSTEM CONFIGURATIONS</b> .....	<b>44</b>
------------------------------------	-----------

---



## Safety Information

TeeJet Technologies is not responsible for damage or physical harm caused by failure to adhere to the following safety requirements.

As the operator of the vehicle, you are responsible for its safe operation.

The Aeros 9040 in combination with any assisted/auto steering device is not designed to replace the vehicle's operator.

Do not leave a vehicle while the Aeros 9040 is engaged.

Be sure that the area around the vehicle is clear of people and obstacles before and during engagement.

The Aeros 9040 is designed to support and improve efficiency while working in the field. The driver has full responsibility for the quality and work related results.

Disengage or remove any assisted/auto steering device before operating on public roads.

## START SIMPLE GUIDANCE

### #1 POWER ON

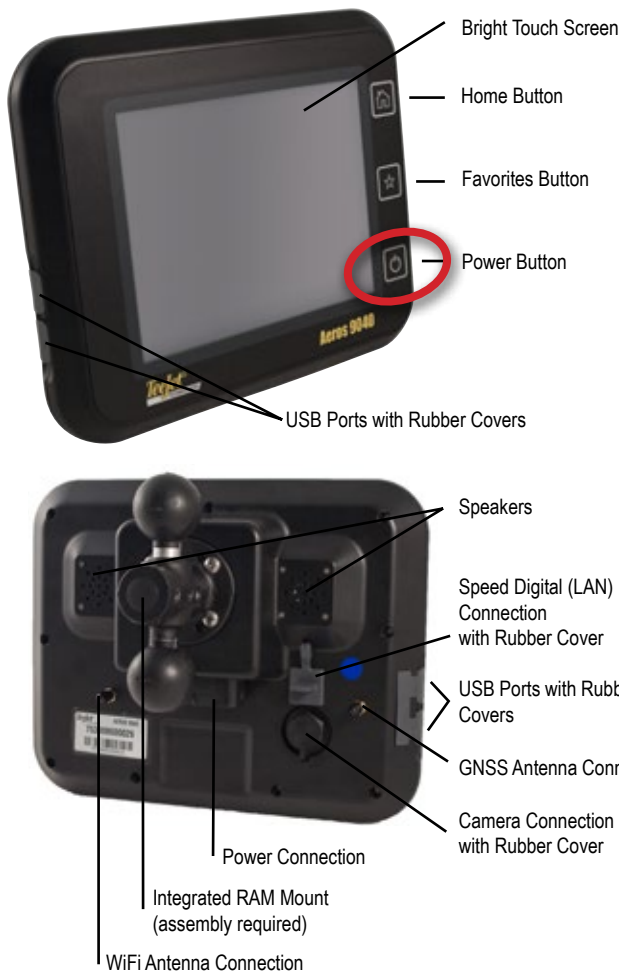

### Recommended Antenna Installation

The GNSS antenna should be mounted as far forward as possible on top of the cab on a metal surface of at least 4 in × 4 in / 10 cm × 10 cm.

### Home Button

The Home button  provides a shortcut to the Home screen.

### Power On/Off Button

On – Press the POWER button  to power on the console. Upon power up, the Aeros will begin its start up sequence.

Off – Press and briefly hold the POWER button  until a confirmation screen acknowledges shut down mode.

**WARNING!** Wait 10 seconds before restarting the console.

### #2 HOME SCREEN

Once the power up sequence has completed, the Home screen will appear with the options to start a new job or continue an existing job.

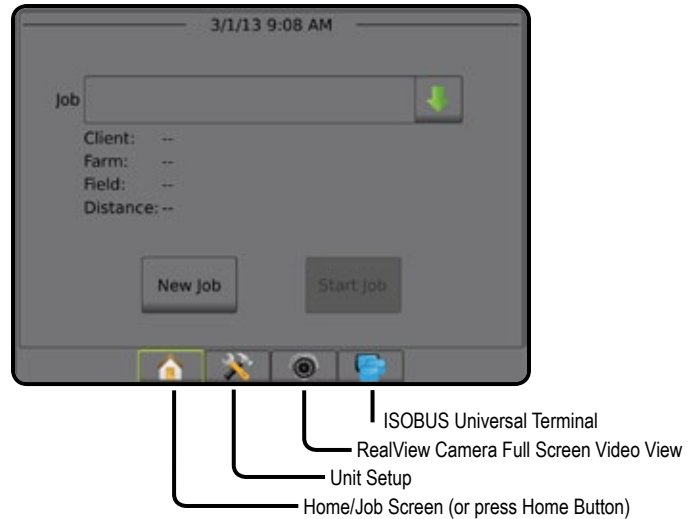

### System Setup

System Setup is used to configure the console, the machine and its implements. Four side tabs access options for Machine/Implement Configuration, Data Management, Console Settings, and Tools.

### RealView Camera Full Screen Video View

View video feed(s) and setup cameras without GNSS available. Options for RealView Guidance are not available on this screen.

### ISOBUS Universal Terminal View

Access to an ISOBUS Electronic Control Unit (ECU) options and operation. This provides crop sprayer or spreader control when integrated into the implement of either capability.

### Simple or Advanced Mode

To change between simple mode and advanced mode, see the configuration chapter under Data → Options.

- ▶ Simple Mode – only one job will be available at a time. Only bounded area and coverage areas are displayed on the home screen. Only the current job is available for saving in Reports. Use with Fieldware Link is not available.
- ▶ Advanced Mode – more than one job will be available at any time. Client, farm, field and job names; bounded and coverage areas; application time; and distance from selected job are displayed on the home screen. All saved job profiles can be exported as a PDF, SHP or KML file to a USB drive using Data → Reports.



## #3 GO TO CONFIGURATION

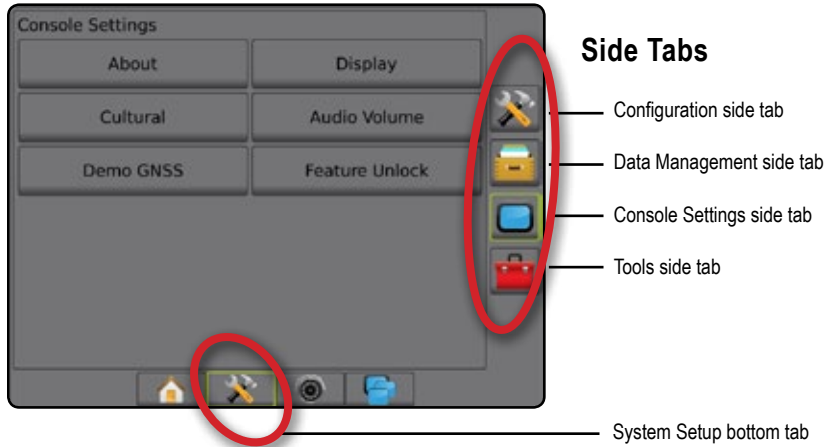

From the Home screen, select the System Setup bottom button to configure the console, the machine and its implements. Four side tabs access options for Machine/Implement Configuration, Data Management, Console Settings, and Tools.



### 1) Set Up the Local Cultural Settings

Cultural is used to configure units, language, and time zone settings for the Aeros console and any Electronic Control Units (ECUs) in the system.



*NOTE: The languages available in a particular ECU may vary.*

1. Press SYSTEM SETUP bottom tab .
2. Press CONSOLE side tab .
3. Press **Cultural**.
4. Select from:
  - ▶ Units – used to define the system units
  - ▶ Language – used to define the system language
  - ▶ Time Zone – used to establish the local time zone



### 2) Set Up the GNSS

GNSS Receiver Configuration is used to configure GNSS Type, GNSS Port, and PRN, and other GNSS parameters, and to view GNSS status information.

1. Press SYSTEM SETUP bottom tab .
2. Press CONFIGURATION side tab .
3. Press **GNSS Receiver Configuration**.
4. Select from:
  - ▶ GNSS Type – sets to accept GNSS source transmissions: GPS, GLONASS, SBAS (with or without DGPS Required)
  - ▶ GNSS Port – sets GNSS communication port to either Internal or External
  - ▶ GNSS Status Information – displays current GNSS status information
  - ▶ Program – only TeeJet support technicians should use this feature
  - ▶ PRN – selects the first of two possible SBAS PRN's to provide SBAS correction data. Set to **Automatic** for automatic PRN selection.
  - ▶ Alternate PRN – when PRN is not automatic, allows possible selection of a second SBAS PRN to provide correction data
  - ▶ Show refresh GNSS position button – establishes if the refresh GNSS position button is available on the guidance screens.
5. Press NEXT PAGE arrow  to set up the selected specific GNSS options.
6. Select:
  - ▶ GPS – single point uncorrected position data based on GPS only with a GGA QI of “1” is accepted.  
*NOTE: GPS is always selected.*
  - ▶ GPS+GLONASS – single point uncorrected position data based on GPS and GLONASS with a GGA QI of “1” is accepted.

- ▶ GPS+SBAS – either single point uncorrected or SBAS corrected position data are accepted - GGA QI of “1” or “2” (3, 4 or 5 are also accepted).
- ▶ GPS+GLONASS+SBAS – either single point uncorrected or SBAS corrected position data are accepted - GGA QI of “1” or “2” (3, 4 or 5 are also accepted).
- ▶ GPS+GLONASS+SBAS+DGPS – only GGA data with a QI value of “2” or higher is accepted (3, 4 or 5 are also accepted).

*NOTE: All console based mapping, application and guidance functions are ceased if the GGA QI value drops below “2” with this setting checked.*

7. Exit this screen to begin initializing the GNSS receiver. This takes about a minute, and the console will not respond until complete.

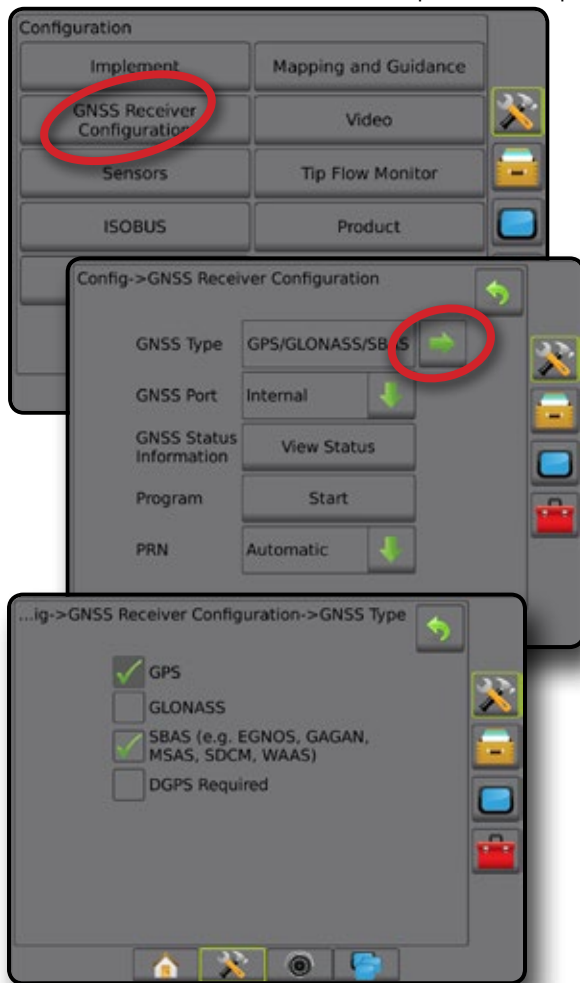

## 3) Set Up the Implement

Implement Setup is used to establish the various settings associated with straight mode, spreader mode, or staggered mode. Available settings will vary depending on the specific equipment present in the system.

### Implement Settings per Equipment Present

This section includes setup options for these implement configurations:

- ▶ Single Section
- ▶ Section(s) with ISOBUS Sprayer/Spreader Setup

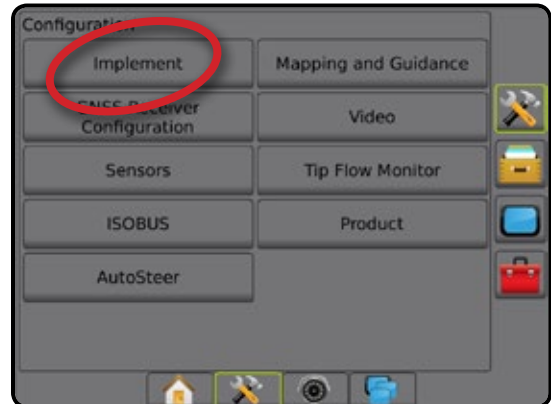

### Single Section Setup

Single Section Setup is used when a SmartCable, Section Driver Module (SDM), or Switch Function Module (SFM) is not on the system (that is, no section control is present). The entire boom or delivery area is considered to be one section.

1. Press CONFIGURATION side tab .
2. Press **Implement**.
3. Select from:
  - ▶ Machine Type [when available]– used to select the type of machine that most closely represents your machine
  - ▶ GNSS Antenna Height [when available]– used to measure the height of the antenna from the ground
  - ▶ Implement Type – used to select the layout of the sections for the applied product location (*see Implement Type section for additional details*)
  - ▶ Working/ Application Width – used to enter the total width of the implement. Range is 3.28 to 246.06 feet / 1.0 to 75.0 meters.
  - ▶ Droplet Size Monitor [when available] – used to enable droplet size monitoring for up to five preselected sprayer tips
  - ▶ Tip Selection [when available] – used to select the type of sprayer tip (series and capacity) for determining droplet size information
  - ▶ Applied Alert – used to establish an alert to signal when exiting or entering an applied area
  - ▶ BoomPilot Start Mode – used to establish whether BoomPilot will be controlled by speed or by the BoomPilot icon

# Aeros 9040 Field Computer

- ▶ BoomPilot Icon – used to activate the guidance screen icon for manually controlling on-screen application painting
4. Press NEXT PAGE arrow  to set up specific implement options. See the Implement chapter for details.



## Section(s) with ISOBUS Sprayer/Spreader Setup

Some Implement options are completed on the ISOBUS ECU. When these options are also available in the Implement Setup section, they will be grayed out or unavailable.

1. Press CONFIGURATION side tab .
2. Press **Implement**.
3. Select from:
  - ▶ Machine Type [when available] – used to select the type of machine that most closely represents your machine
  - ▶ GNSS Antenna Height [when available] – used to measure the height of the antenna from the ground
  - ▶ Implement Type – used to select the layout of the sections for the applied product location
  - ▶ Application Width [Straight Implement Type completed on ISOBUS ECU] – used to display the total width of the implement as entered on the ISOBUS sprayer
  - ▶ Working Width [Spreader Implement Type completed on the ISOBUS ECU] – used to display the total width of the implement as entered on the ISOBUS spreader
  - ▶ Droplet Size Monitor [available only with Pressure Sensor Interface Kit] – used to enable droplet size monitoring for up to five sprayer tips

- ▶ Tip Selection [Straight Implement Type completed on the ISOBUS ECU] – used to display the type of sprayer tip as entered on the ISOBUS sprayer
- ▶ Applied Alert – [only available without a switchbox] used to establish an alert to signal when exiting or entering an applied area
- ▶ BoomPilot Start Mode – used to control BoomPilot automatically by speed, or manually by BoomPilot icon
- ▶ BoomPilot Icon – used to activate icon for manually controlling BoomPilot

4. Press NEXT PAGE arrow  to set up specific implement options.

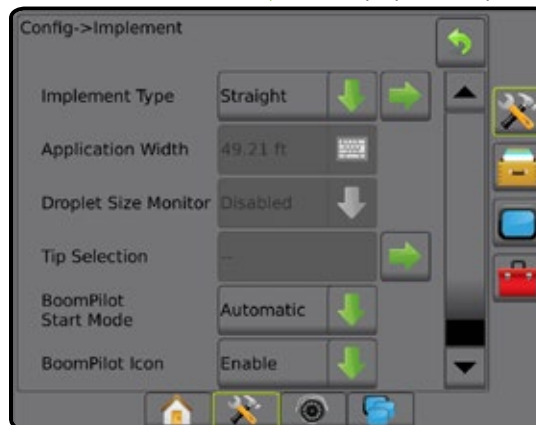

## Additional Settings per Implement Type

Implement Type selects the type of application pattern that most closely represents your system.

- In Straight Mode – the boom sections have no length and are on a line a fixed distance from the antenna
- In Spreader Mode – a virtual line is created in line with the delivery disks from which the application section or sections can vary in length and can be at different distances from the line (availability depends on the specific equipment in the system)
- In Staggered Mode – a virtual line is created in line with Section 1 from which the application section or sections have no length and can be at different distances from the line (availability depends on the specific equipment in the system)

Figure 1: Implement Type – Straight

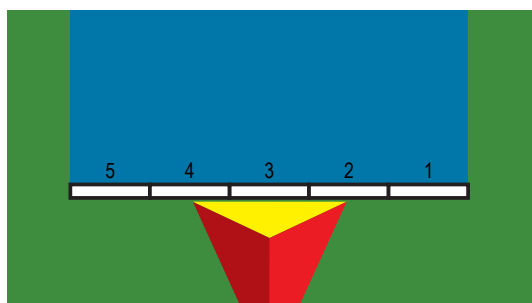



Figure 2: Implement Type – Spreader

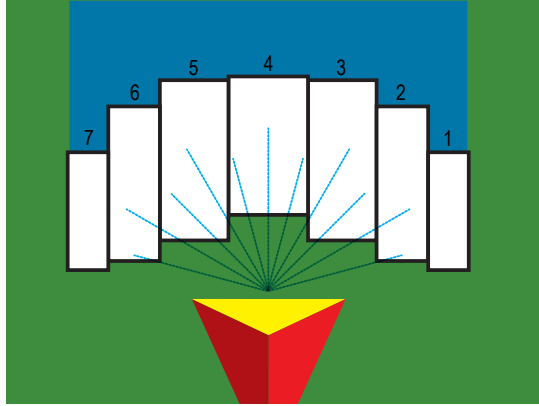
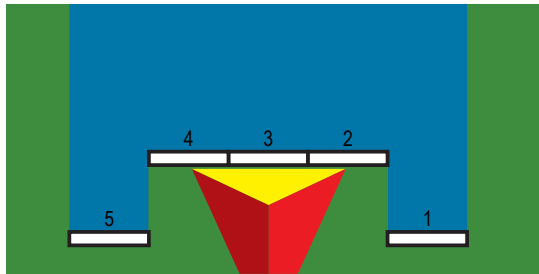

Figure 3: Implement Type – Staggered



## Section Numbers

Sections are numbered from left to right while facing in the machine's forward direction.

## Straight

The boom sections have no length and are on a line a fixed distance from the antenna.

1. Select **Straight** implement type on Implement screen.
2. Press Implement Type NEXT PAGE arrow .
3. Select from:
  - ▶ Connection Point In-line Offset Direction **3** [ISOBUS only] – establishes if reference point **B** is located in front of (forward) or behind (backward) the GNSS antenna while facing in the machine's forward direction
  - ▶ Connection Point In-line Offset Distance **3** [ISOBUS only]– measured in parallel to the centerline of the machine, defines the in-line distance from the GNSS antenna to reference point **B**
  - ▶ Connection Point Lateral Offset Direction **4** [ISOBUS only]– defines the lateral direction, either left or right, from the centerline of the machine to the center of reference point **B** while facing in the machine's forward direction
  - ▶ Connection Point Lateral Offset Distance **4** [ISOBUS only]– defines the lateral distance from the centerline of the machine to the center of reference point **B**
  - ▶ Implement In-line Offset Direction **1** – displays if the implement is located in front of (forward) or behind (backward) the GNSS antenna while facing in the machine's forward direction

- ▶ Implement In-line Offset Distance **1** – measured in parallel to the centerline of the machine, displays the in-line distance from the GNSS antenna to the implement
- ▶ Implement Lateral Offset Direction **2** – displays the lateral direction, either left or right, from the centerline of the machine to the center of the implement while facing in the machine's forward direction
- ▶ Implement Lateral Offset Distance **2** – displays the lateral distance from the centerline of the machine to the center of the implement
- ▶ Overlap – used to define the amount of overlap allowed when using automatic boom section control
- ▶ Delay On Time – used to set the time when the section will switch on when entering an area that has not been applied  
*NOTE: If the application turns on too soon when entering an unapplied area, decrease the Delay On Time. If the application turns on too late, increase the Delay On Time.*
- ▶ Delay Off Time – used to set the time when the section will switch off when entering an area that has been applied  
*NOTE: If the application turns off too soon when entering an unapplied area, decrease the Delay Off Time. If the application turns off too late, increase the Delay Off Time.*

\*Available with SmartCable, Section Driver Module (SDM) or Switch Function Module (SFM) or ISOBUS)

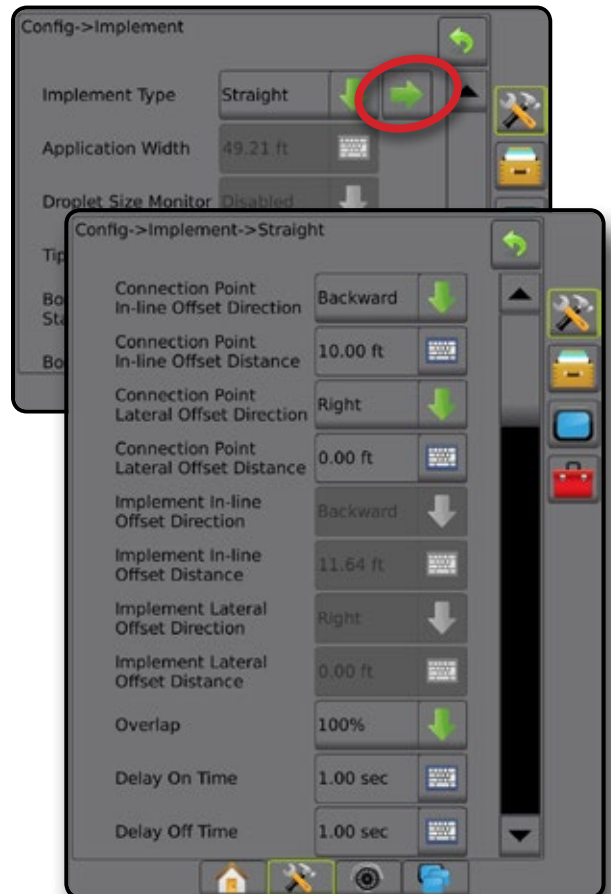

# Aeros 9040 Field Computer

Figure 4: Implement Offset Directions and Distances

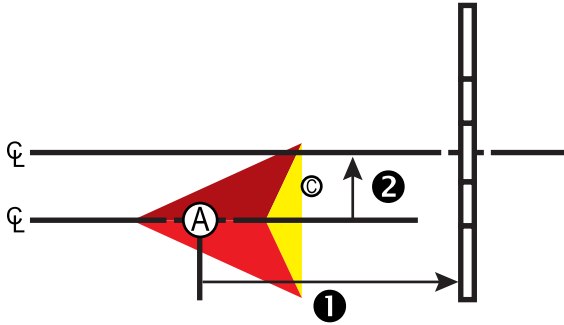
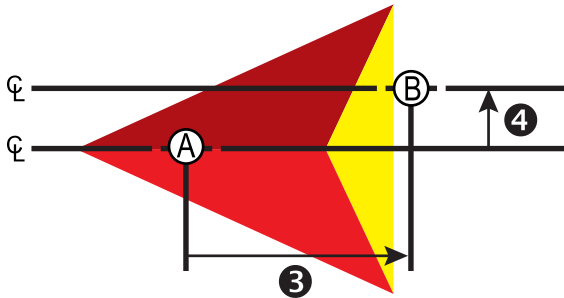

Figure 5: Connection Point Offset Directions and Distances



- Ⓐ – Center of the GNSS antenna
- Ⓑ – Reference point
- ❶ – Implement In-line Offset Direction/Distance
- ❷ – Implement Lateral Offset Direction/Distance
- ❸ – Connection Point In-line Offset Direction/Distance
- ❹ – Connection Point Lateral Offset Direction/Distance

## Spreader – TeeJet

A virtual line is created in line with the delivery disks from which the application section or sections can vary in length and can be at different distances from the line (availability depends on the specific equipment in the system).

1. Select **Spreader** implement type on Implement screen.
2. Press Implement Type NEXT PAGE arrow →.
3. Select from:
  - ▶ Setup type – used to select **TeeJet** spreader type
  - ▶ Antenna to Disks In-line Offset Distance ❶ – measured in parallel to the centerline of the machine, defines the in-line distance from the GNSS antenna to the disks, or dispersal mechanism
  - ▶ Implement Lateral Offset Direction ❷ – defines the lateral direction, either left or right, from the centerline of the machine to the center of the implement while facing in the machine's forward direction
  - ▶ Implement Lateral Offset Distance ❷ – defines the lateral distance from the centerline of the machine to the center of the implement
  - ▶ Overlap – used to define the amount of overlap allowed when using automatic boom section control

- ▶ Delay On Time – used to set the time when the section will switch on when entering an area that has not been applied  
*NOTE: If the application turns on too soon when entering an unapplied area, decrease the Delay On Time. If the application turns on too late, increase the Delay On Time.*
- ▶ Delay Off Time – used to set the time when the section will switch off when entering an area that has been applied  
*NOTE: If the application turns off too soon when entering an unapplied area, decrease the Delay Off Time. If the application turns off too late, increase the Delay Off Time.*
- ▶ Spread Offset Distance ❸ – used to set the distance between the disks or dispersal mechanism and where product initially hits the ground on Section 1.
- ▶ Section Offsets ❹ – used to set the offset distance from section 1 (the Spread offset line) to the leading edge of each section. Section 1 is always 0. All other sections can be different distances.
- ▶ Section Lengths ❺ – used to set the length of application in each section. Each section can be a different length.  
*NOTE: Sections are numbered from left to right while facing in the machine's forward direction.*

\*Available with SmartCable, Section Driver Module (SDM), or Switch Function Module (SFM) or ISOBUS)

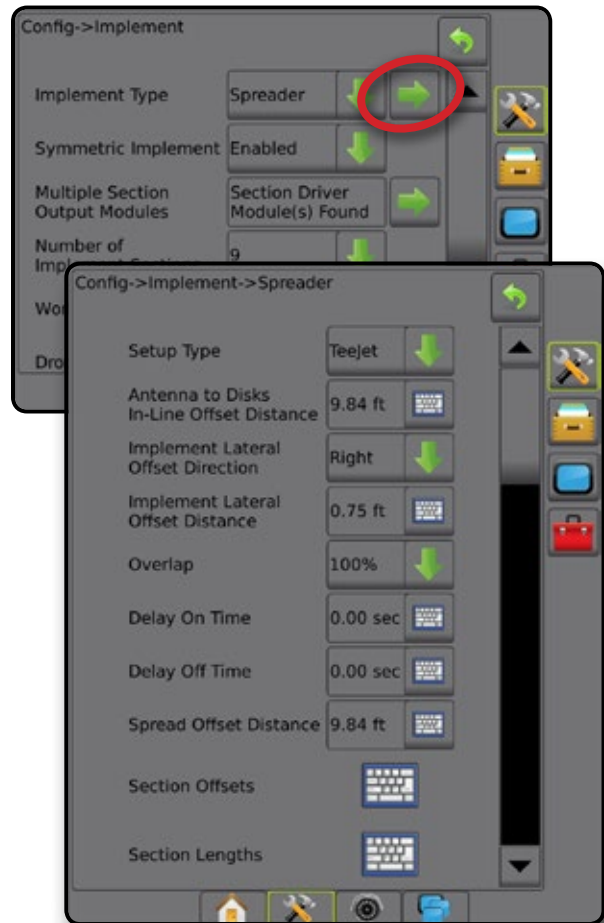
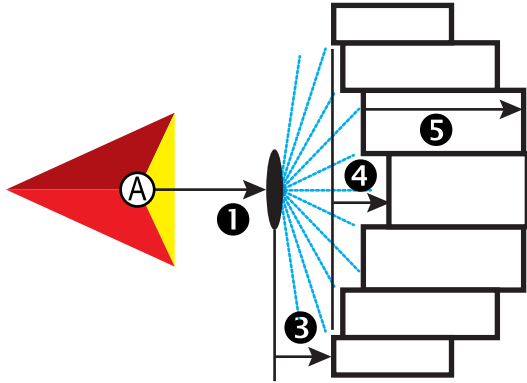
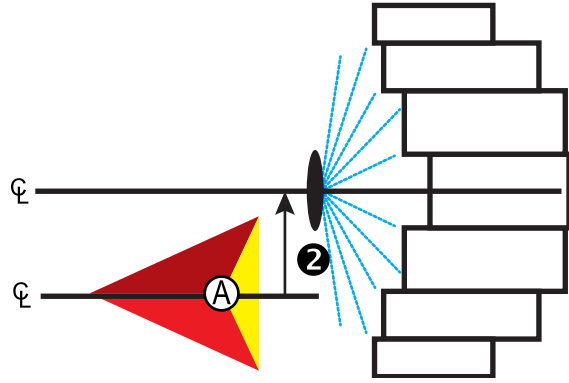

Figure 6: Distances and Length



- Ⓐ – Center of the GNSS antenna
- ① – Antenna to Disks In-line Offset Distance
- ② – Implement Lateral Offset Direction/Distance

Figure 7: Lateral Offset Direction and Distance



- ③ – Spread offset distance
- ④ – Section offsets
- ⑤ – Section lengths

## Lateral Implement Offset Distance Adjustment

Lateral implement offset distance is used to enter the distance from the center line of the machine to the center of the implement. When on-screen mapping shows no overlap or gap, yet field application produces an overlap or gap consistently to only one side in the direction of travel, an adjustment to the lateral implement offset distance should be calculated and made to the implement offset distance value.

If using a self-propelled sprayer or spreader, use the GNSS Offset Adjustment Calculation to calculate the implement offset distance adjustment.

If using a pull behind or trailed implement, use the Implement Offset Adjustment Calculation to calculate the implement offset distance adjustment.

**NOTE:** While using assisted/auto steering, if on-screen mapping shows overlaps and gaps, adjustments may need to be made to the assisted/auto steering settings.

## GNSS Offset Adjustment Calculation

To calculate a GNSS offset adjustment using the same guideline:

1. Create a straight AB line.
2. With assisted/auto steering engaged, drive pass ① at least 30 meters, and place flags at the draw bar or next to the machine.
3. Turn around and engage assisted/auto steering on pass ② on the same AB guideline. Place flags at the draw bar or next to the machine, or stop while on the AB guideline next to the flags you placed on pass ①.
4. Measure the difference ③ between the flags of pass ① and pass ②.
5. Divide the measured distance ③ in half. This difference will be the offset adjustment.
6. Increase or decrease the offset distance as needed dependent on where the field application overlap occurs and the current implement offset direction setting.

Field Application Overlap	Current Offset Settings		
	Offset Direction = Left	Offset Direction = Right	Offset Direction = Right Offset Distance = 0 ft/m
To the right of pass ①	Increase distance offset value	Decrease distance offset value	Increase distance offset value
To the left of pass ①	Decrease distance offset value	Increase distance offset value	Change to implement offset direction to left and increase distance offset value

Figure 8: GNSS Offset Distance

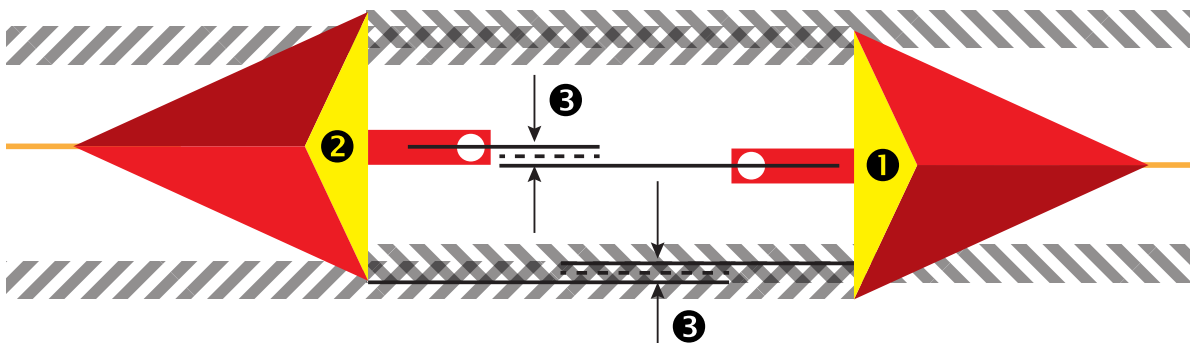

# Aeros 9040 Field Computer

## Lateral Implement Offset Adjustment

To calculate an implement offset adjustment using adjacent guidelines:

1. Create a straight AB line.
2. With assisted/auto steering engaged, drive pass ① as if you were operating the implement, and place flags at the outside edges of the implement.
3. Turn around and engage assisted/auto steering on pass ② on the adjacent AB guideline. Place additional flags at the outside edges of the implement or stop while on the AB guideline next to the flags you placed on pass ①.
4. Measure the difference ③ between the flags of pass ① and pass ②.
5. Divide the measured distance ③ in half. This difference will be the offset adjustment.
6. Increase or decrease the offset distance ④ as needed dependent on where the field application overlap occurs and the current implement offset direction setting.

Field Application	Current Offset Settings		
	Offset Direction = Left	Offset Direction = Right	Offset Direction = Right Offset Distance = 0 m
Overlap on the right of pass ① or Gap on the left of pass ①	Increase distance offset value	Decrease distance offset value	Increase distance offset value
Overlap on the left of pass ① or Gap on the right of pass ①	Decrease distance offset value	Increase distance offset value	Change to implement offset direction to left and increase distance offset value

Figure 9: Lateral Implement Offset Distance and Direction

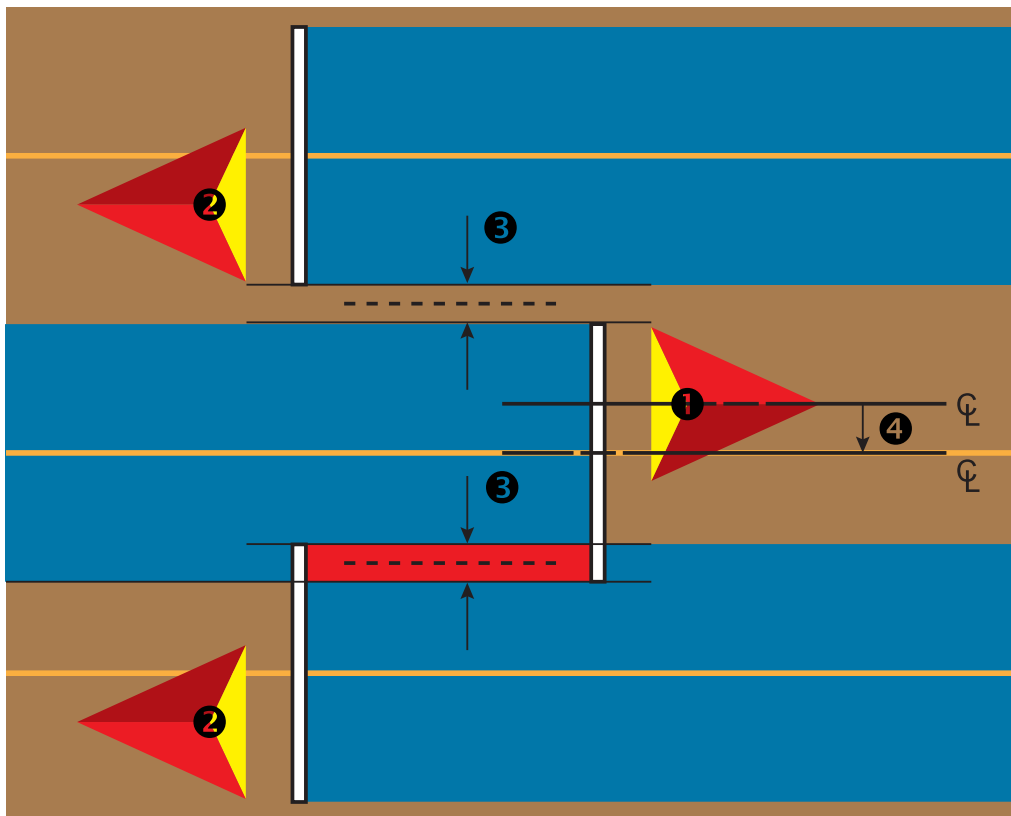

## 4) Set Up the Mapping Location

Mapping location establishes the location from which boundary and polygon mapping will take place.





1. Press CONFIGURATION side tab .
2. Press **Mapping and Guidance**.
3. Select from:
  - ▶ Mapping Location – establishes the layout of the location from which the boundary or polygon will be mapped.
    - Default Location – While creating an exterior boundary or polygon, the line will be to the exterior of the outermost active section. While creating an interior boundary, the line will be to the interior of the innermost active section. If no sections are active, the boundary will be marked to the end of the outermost section.
    - User Entry – in-line and lateral offset from the GNSS antenna directions and distances can be specified by the user. Up to five (5) user entries can be created. See “User Entered Mapping Location” for details.
  - ▶ Guidance Width – used to set the distance between guidelines
  - ▶ Guidance Sensitivity – sets the distance around the guideline that is perceived as zero error.
4. Select user entry location from the Mapping Locations drop-down options.
5. Press MAPPING LOCATION NEXT PAGE arrow  to set up the selected specific mapping location options.
6. Select:
  - ▶ Location Name – used to enter the name of the mapping location for the current user entry selected
  - ▶ Mapping Location In-line Offset Direction – used to select whether the mapping location is located in front of or behind the GNSS antenna as the vehicle moves in a forward direction
  - ▶ Mapping Location In-line Offset Distance – used to define the in-line distance from the GNSS antenna to the mapping location
  - ▶ Mapping Location Lateral Offset Direction – used to select the lateral direction from the centerline of the machine to the mapping location while facing in the machine's forward direction
  - ▶ Mapping Location Lateral Offset Distance – used to define the lateral distance from the centerline of the machine to the mapping location
7. Press RETURN arrow  to return to the Mapping and Guidance screen or CONFIGURATION side tab  to return to the main Configuration screen.

Figure 10: User Entered Mapping Location



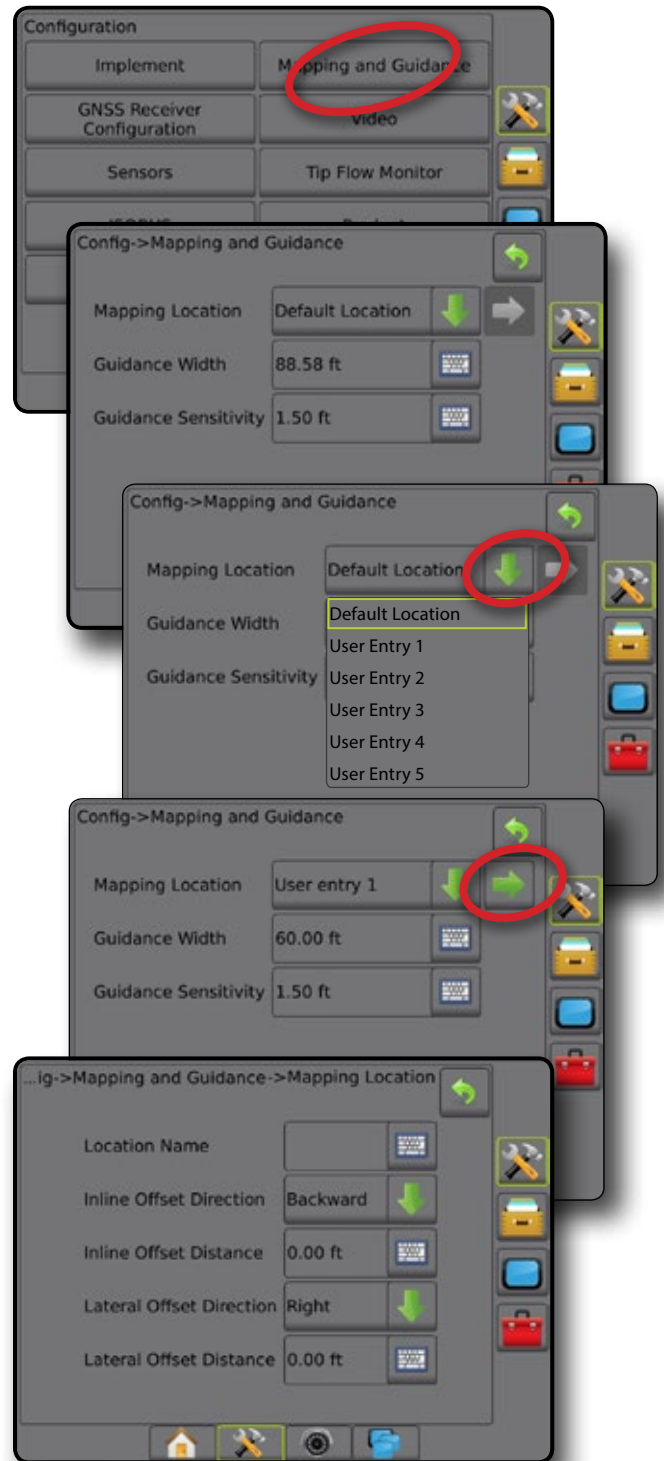

# Aeros 9040 Field Computer

## #4 START NEW JOB OR CONTINUE JOB

Once the power up sequence has completed, the Home screen will appear with the option to start a new job or continue an existing job. The console must have GNSS before starting or continuing a job. **Setup for the specific machine and its components must be completed before starting a job.** Once a job is active, some setup options can no longer be changed. To change between simple and advanced mode, go to Data-> Options-> Job Mode in the System Setup.

### Simple Mode

In simple mode, only one job will be available at a time.

#### New Job

1. On the Home screen , press **New Job**.

#### Continue Job

1. On the Home screen , press **Continue**.

If the current job is in a UTM zone other than the current or adjacent UTM zone **Continue** will be disabled.

#### Close Job

1. On the Home screen , press **Close Job**.

To create a report of the job when closing a job, Insert a USB drive into the USB port of the console before pressing "Close Job".



### Advanced Mode

In advanced mode, more than one job will be available at any time.

Client information, farm information, field information, and prescription maps can only be inputted using Fieldware Link. A job name can only be edited using Fieldware Link.

A user can duplicate jobs for reuse of guidelines, boundaries, applied data, prescription map and/or polygons using Fieldware Link or Data -> Job Data -> Manage in the console.



#### New Job

1. On the Home screen , press **New Job**.
2. Press:
  - ▶ Yes – to automatically generate a name
  - ▶ No – to enter a name using the on screen keyboard

Client, farm, and field information are inputted using Fieldware Link.

#### Start Job

The Aeros 9040 is programmed with a field finder tool to assist the user in finding the job closest to the vehicle's location. With GNSS acquired, the job pick list will be updated every ten seconds. During this update, the list of jobs is sorted by distance and the closest two jobs are displayed on the top of the list. The remaining jobs are listed beneath these.

1. On the Home screen , press DOWN arrow  to access the list of jobs saved in the console.
2. Select the job name to be started/continued.
3. Press **Start Job**.

#### Close Job

1. On the Home screen , press **Close Job**.

To create a report of the job when closing a job, Insert a USB drive into the USB port of the console before pressing **Close Job**.

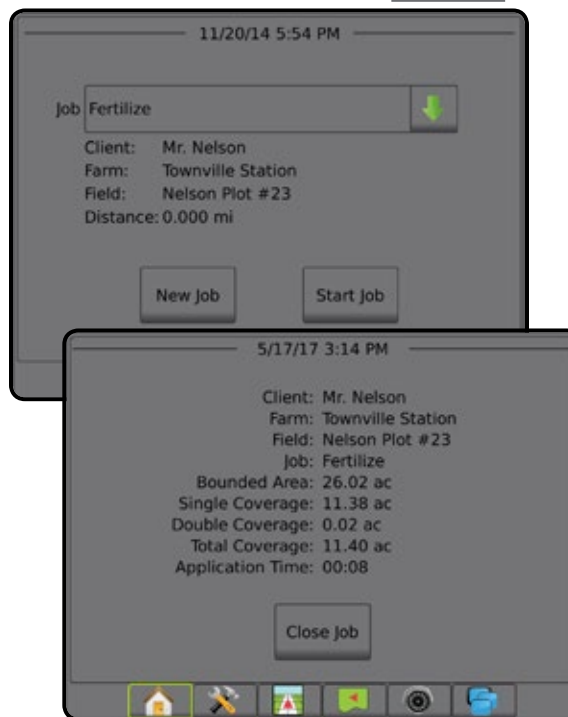

## #5 SET UP GUIDANCE

### 1) Choose a Guidance Mode

Three guidance screens assist in keeping you informed.

**Vehicle View guidance** creates a computer-generated image of the vehicle position displayed in the application area.

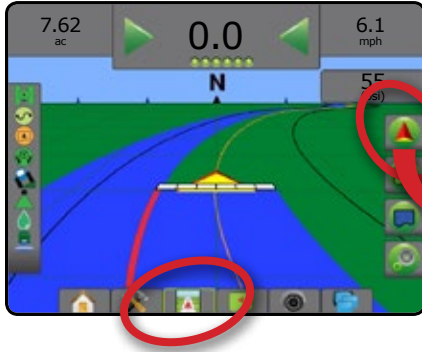



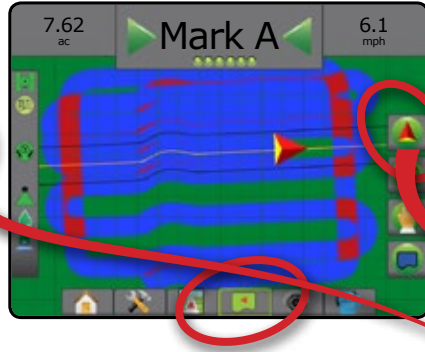





**Field View guidance** creates a computer-generated image of vehicle position and application area from an aerial perspective.



**RealView guidance** allows live video input to be displayed instead of a computer-generated image.



To choose a guidance mode:



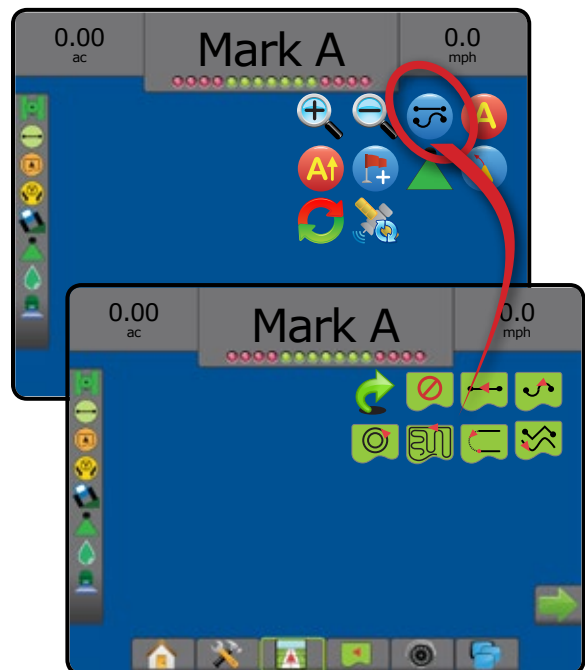

2. Press NAVIGATION AND GUIDANCE OPTIONS tab  to display navigation options.
3. Press GUIDANCE MODE icon .
4. Select from:
  - ▶ No Guidance 
  - ▶ Straight AB Guidance 
  - ▶ Curved AB Guidance 
  - ▶ Circle Pivot Guidance 
  - ▶ Last Pass Guidance\* 
  - ▶ NextRow Guidance\* 
  - ▶ Adaptive Curve Guidance 

*\*Guidance options may not be available depending on assisted/automatic steering system installed.*

Figure 11: Choose a Guidance Mode



## 2) Establish an AB guideline

1. Drive to the desired location of Point A .
2. Press NAVIGATION AND GUIDANCE OPTIONS tab  to display navigation options.
3. Press MARK A icon .
4. Drive to the desired location of Point B .
5. Press MARK B icon  to establish the AB line.
6. "Would you like to name this guideline?"  
Press:
  - ▶ Yes – to enter a name and save the guideline in the console
  - ▶ No – to automatically generate a name and save the guideline in the console

The console will begin providing navigation information.

**NOTE:** The MARK B Icon  is not available for selection (grayed out) until the minimum distance is travelled (9.84 feet / 3.0 meters in Straight or Curved guidance, 164.04 feet / 50.0 meters in Circle Pivot guidance).

**NOTE:** It is not necessary to drive the entire circumference of the center pivot in order to initiate Circle Pivot Guidance.

Use CANCEL MARK icon  to cancel the Mark A command and revert to the previous guideline (when established).

Figure 12: Mark A Point

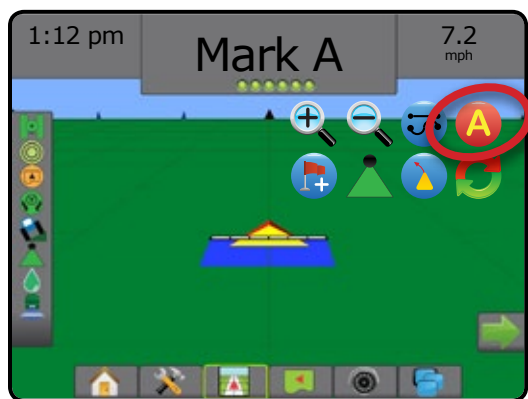
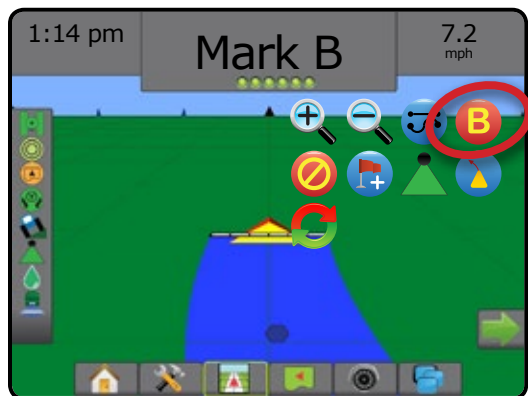



Figure 13: Mark B Point



## 3) Create an Application Boundary

Available on any guidance screen, the Boundaries and polygons tab displays exterior boundary, interior boundary and polygon options.

Application boundaries establish the work areas where product is or is not applied while using ASC or BoomPilot.



- Exterior Boundary  – establishes a work area where application will be applied while using ASC or BoomPilot.
- Interior Boundary  – establishes a work area where application will NOT be applied while using ASC or BoomPilot.

Boundaries can be established in all guidance modes. Up to 100 total exterior boundary and/or interior boundaries can be stored within a single job. Application is not required to map a boundary.

Using Data -> Job Data -> Manage or with Fieldware Link, a user can duplicate and edit jobs for reuse of boundaries for different applications over the same field.

Application is not required to map a boundary or polygon.



If mapping a boundary or polygon with one or more sections folded in and turned off, it is necessary to maintain this section configuration for the duration of the boundary or polygon pass. Any changes made to the number of sections turned on, and therefore the width of the machine after the boundary or polygon mapping process has started, will result in the application mapping the boundary or polygon at the outer edge of all the programmed sections – not necessarily those turned on at any given time during the boundary or polygon pass.

When mapping a boundary or polygon with some sections turned off, it is necessary to turn BoomPilot to Manual mode  and turn ON the master and section switches for all sections that will be used during the boundary or polygon pass. Once the boundary or polygon pass is complete the sections switches can be turned OFF, master switch remains ON, BoomPilot can be returned to Automatic mode  and automatic section control can then be used.

**NOTE:** If a boundary is mapped with some sections folded as described above, it may be necessary to use the A+ NUDGE icon  on the guideline over to the correct position for subsequent passes in the field.







### Establishing an Exterior or Interior Boundary

To establish an exterior or interior boundary:



1. Drive to a desired location at the perimeter of the application area and orientate the vehicle in association to the established mapping location.
2. Press BOUNDARY AND POLYGON OPTIONS tab  to display boundary and polygon options.
3. Press MARK BOUNDARY icon  .
4. Verify that the Mapping location is correct.
  - ◀ If the Mapping location is not correct, press **Cancel** then go to Configuration-> Mapping and guidance-> Mapping location.

- Travel the perimeter of the application area.

While traveling, use as needed:

- ▶ Pause Boundary   – pauses the mark boundary process.
- ▶ Resume Boundary   – resumes the mark boundary process.
- ▶ Cancel Boundary   – cancels mark boundary process.

- Finish the boundary:

- ▶ Automatic close – travel to within one swath width of the starting point. The boundary will close automatically (the white guideline will turn black).
- ▶ Manual close – press the FINISH BOUNDARY icon   to close the boundary with a straight line between the current location and the starting point.

*NOTE: If the minimum distance is not travelled (five times the swath width), an error message will pop-up.*

- Press:

- ▶ Save – to save the boundary
- ▶ Delete – to delete the boundary

Figure 14: Exterior Boundary

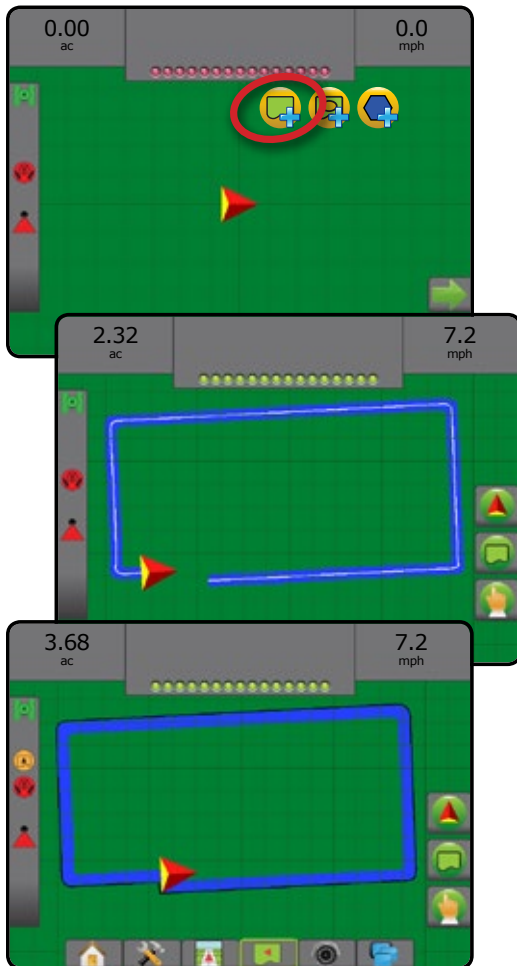
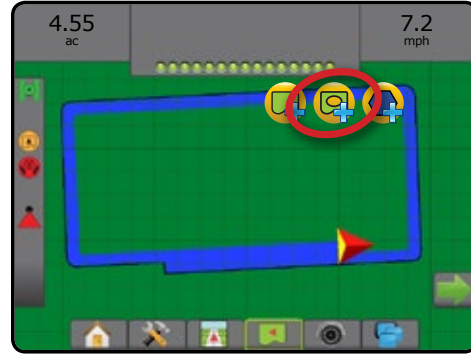

Figure 15: Add Interior Boundary



## Delete Last Marked Boundary



Use DELETE BOUNDARY icon  to delete the last marked boundary (interior or exterior) from the current job. Press again to remove additional boundaries in order from last to first created.

Figure 16: Delete Last Marked Boundary

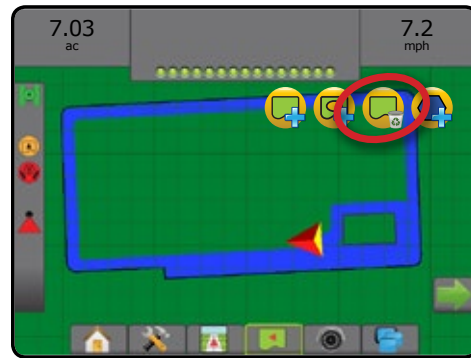

## Boundary on Status Bar

In reference to your current location, the IN EXTERIOR BOUNDARY icon  or OUT OF EXTERIOR BOUNDARY icon  is displayed on the Status Bar once a boundary is established.

- Press BOUNDED AREA icon .
  - ◀ Working Area – total area of all exterior boundaries
  - ◀ Field Area – total area of all exterior boundaries minus the area of all interior boundaries
  - ◀ Internal Area – total area of all interior boundaries

Figure 17: Boundary on Status Bar



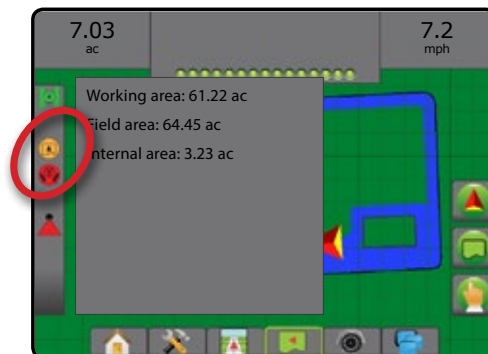

## ADD RATE CONTROL

*NOTE: TeeJet Dual Control Module (DCM) is no longer supported and will not be referenced in this manual.*

ISOBUS universal terminal (UT) gives access to an ISOBUS electronic control unit (ECU) options and operation. This provides crop sprayer or spreader control when integrated into the implement of either capability.

*NOTE: For detailed setup instructions, refer to the specific ISOBUS user manual for the connected ECU.*

1. Press UNIVERSAL TERMINAL bottom tab .

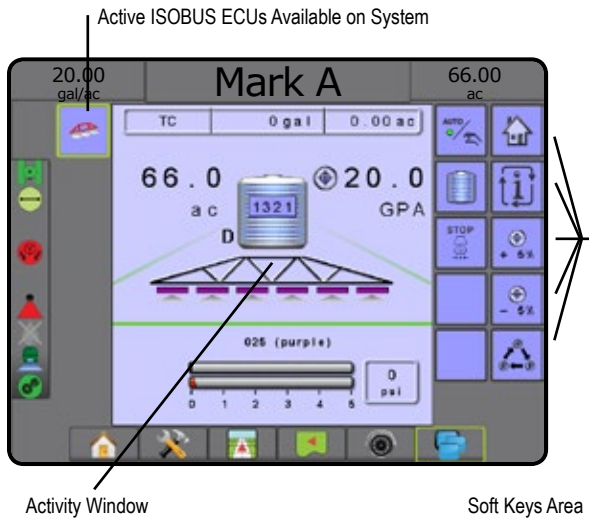

## Guidance Screen Options

When a ISOBUS Electronic Control Unit (ECU) sprayer or spreader control is integrated into the implement, rate control options and mapping options are available on the Vehicle View and Field View guidance screens.

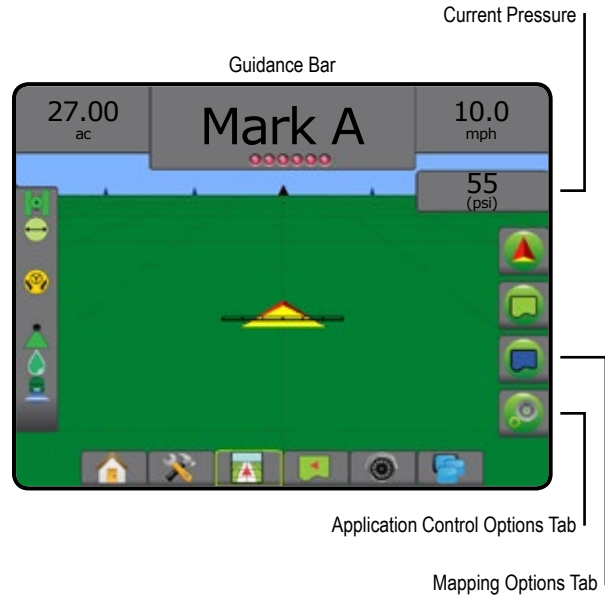

## Ready for Operation

Upon starting up the system, an ISOBUS product may take a few minutes to load all required information or object pools.

Before starting a job, check to be sure the ISOBUS ECU is ready.

- Home Screen is available
- Tack Control (TC) is active – Active Trip Count Number should show “TC”



## Current Pressure

Displays the current pressure to the tip.

## Guidance Bar

In addition to the standard Guidance bar options, the following selectable information will become available with an ISOBUS ECU:

- ▶ Actual Application Rate – displays the current application rate
- ▶ Target Application Rate – displays the target application rate
- ▶ Volume/Product Applied – displays the volume or weight of product applied
- ▶ Tank/Bin Amount Remaining – displays the volume or weight of product remaining in the tank/bin

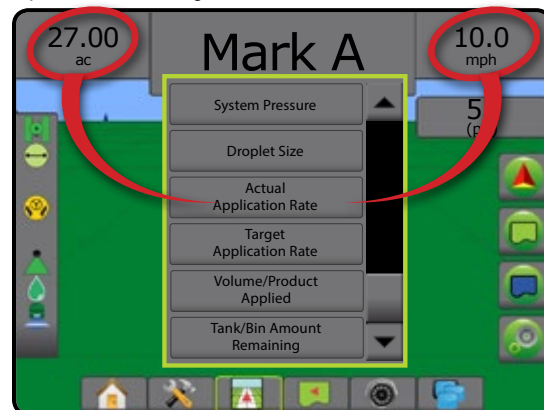











## Mapping

GNSS-based product application mapping is available in Vehicle View or Field View. Mapping can record areas covered by the implement (Coverage) or how much product has been applied and where (Application) and can direct single- and variable-rate product application (Preset Target Rate and Prescription, respectively).

*NOTE: For more information, see "Application Mapping".*

1. Press VEHICLE VIEW GUIDANCE bottom tab  or FIELD VIEW GUIDANCE bottom tab .
2. Press MAPPING OPTIONS tab  to display mapping options.
3. Select one or more:
  - ▶ Coverage Map 
  - ▶ Polygons 
  - ▶ Prescription Map 
  - ▶ Application Map 
  - ▶ Target Rate Map 



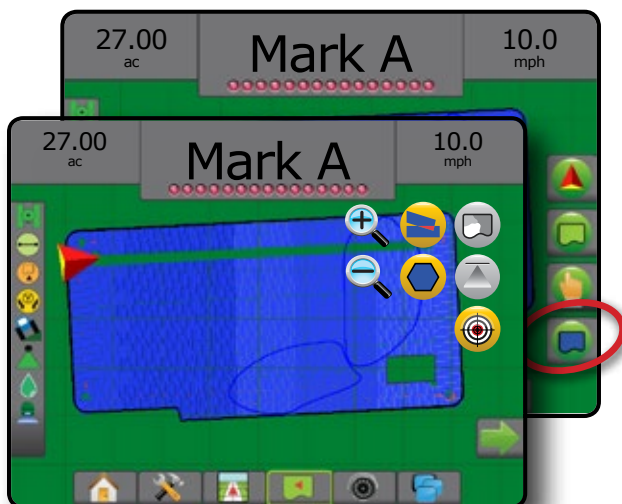

*NOTE: Application Map and Target Rate Map cannot be selected simultaneously.*



## Application Control

Target Rate Percentage Increase/Decrease icons increase/decrease the application target rate per the established percentage set in the Machine Operation setup screen under Application Rate Step. Automatic regulation mode will automatically adjust the application rate based on the current speed in reference to the target rate.

*NOTE: The Target Rate Percentage Increase/Decrease icons do the same adjustment as the Boost/Step Percentage Increase/Decrease Keys from the ISOBUS UT.*

1. Press VEHICLE VIEW GUIDANCE bottom tab .
2. Press APPLICATION OPTIONS tab .
3. Select from:
  - ▶ Target Rate Percentage Increase  – establishes the required boost percentage step increase
  - ▶ Target Rate Percentage Decrease  – establishes the required boost percentage step decrease
  - ▶ Percentage Boost and Reset  – shows current boost percentage step and when pressed, zeros the boost percentage step

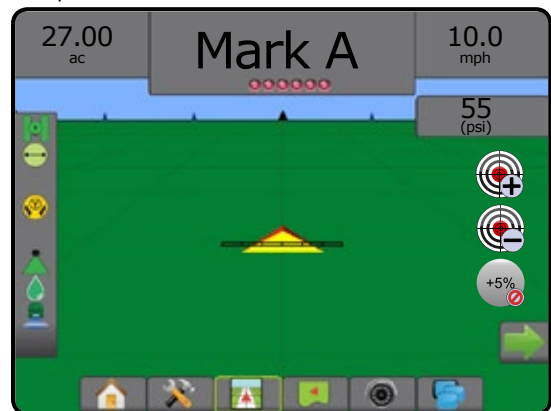

## MAPPING OPTIONS

On vehicle view or field view guidance screens, in any guidance mode, the mapping options tab displays options to display polygon maps, coverage maps and application maps.

Polygon and coverage mapping are available when a polygon has been established.

GNSS-based product application mapping is available when a rate controller is on the system. Rate control mapping can record areas covered by the implement (Coverage) or how much product has been applied and where (Application), and can direct single- and variable-rate product application (Preset Target rate and Prescription, respectively).

*NOTE: Before using mapping, set or verify product mapping options under Configuration->Product.*









### Duplicating and Transferring Maps

Maps are stored in the job data. Using Data-> Job Data, job data containing maps can be duplicated or transferred to Fieldware Link so the maps can be opened, viewed, edited, and printed, and transferred back to the console. See "Data management->Job data-> Transfer" and "Data Management-> Job Data-> Manage" in the System Setup chapter for details.

Using Data-> Reports, reports in multiple formats can be generated that contain data and any maps from the job.

# Aeros 9040 Field Computer

To access application mapping:

1. Press VEHICLE VIEW GUIDANCE bottom tab  or FIELD VIEW GUIDANCE bottom tab .
2. Press MAPPING OPTIONS tab  to display mapping options.
3. Select one or more:
  - ▶ Coverage map  – shows areas covered by the implement, regardless of whether product was applied
  - ▶ Polygons  – shows all mapped polygons
  - ▶ Prescription map  – pre-loaded map that provides information to the rate controller for use in applying product
  - ▶ Application map  – shows how much product has been applied and where, using color to indicate level in proportion to preset or automatically set maximum and minimum levels
  - ▶ Target Rate map  – shows the application rate that the rate controller attempted to achieve at each location

*NOTE: Application Map and Target Rate map cannot be selected simultaneously.*

Figure 18: Coverage, Polygon and Target Rate Maps

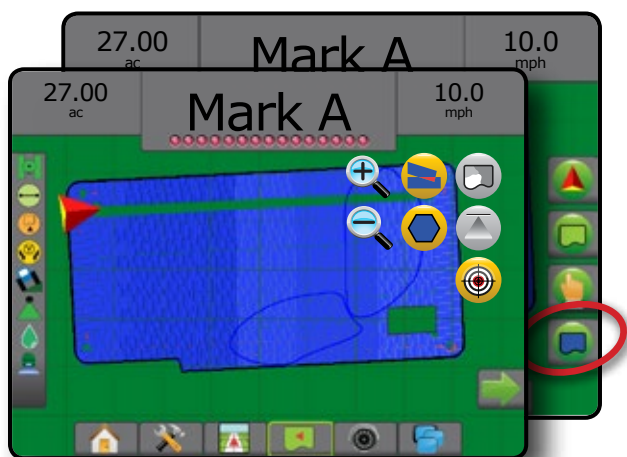

## Coverage Map

 Coverage map showing areas covered by the implement. ISOBUS requires product to be applied.

- Coverage area – illustrates applied area and overlap:
  - ◀ Blue – one application
  - ◀ Red – two or more applications

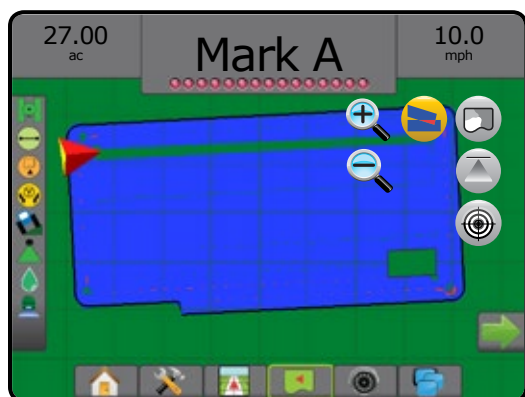

## Polygons Map

 Polygon map shows all mapped polygons.

- Guidelines
  - ◀ Blue – polygon boundary line



## Prescription Map

 Prescription map is a pre-loaded map that provides information to the rate controller for use in applying product. Prescription maps contain geo-referenced product rate information. The Aeros 9040 can import job data containing Prescription maps for use with variable-rate application (VRA) using compatible rate controllers.

- Zone Lines:
  - ◀ Black when approaching the application zone.
  - ◀ White when within the application zone.
  - ◀ Other zones having the same rate will also be shown in white.
- Coverage Area – illustrates different prescription rate zones:
  - ◀ User selected – zone colors are selected when establishing the prescription map.

With Fieldware Link (v5.01 or later), users can import VRA jobs created in Fieldware Link, as well as export job data from the console, edit the included maps to create Target rate or Prescription maps, and transfer back to the console for job use.

*NOTE: Advanced Job Mode is required for variable rate applications. See Options (Job mode) in the System Setup chapter.*

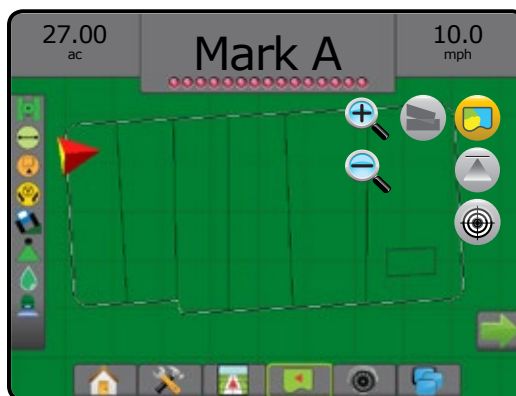

## Application and Target Rate Maps

Application Map  shows how much product has been applied and where, using color to indicate level in proportion to preset or automatically set maximum and minimum levels

Target Rate Map  shows the application rate that the rate controller attempted to achieve at each location

*NOTE: Application map and Target Rate map cannot be selected simultaneously.*

### Application Map

- Coverage area – illustrates applied area:
  - User selected – applied areas show colored bars relative to selected color range and map selection.

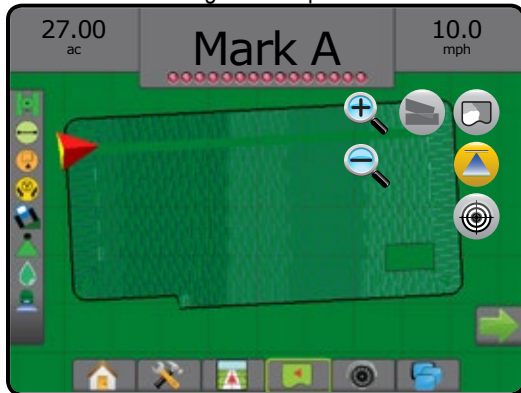

### Target Rate Map

- Coverage area – illustrates applied area:
  - User selected – applied areas show colored bars relative to selected color range and map selection.

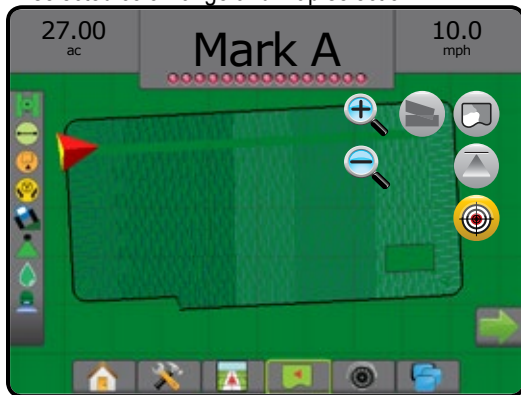

### Target Rates

Preset target application rates define target rates of product being applied per hectare/acre. These settings will set the same for all active jobs.

Target rates are established on the ISOBUS ECU using the ISOBUS UT. The current Target rate is selected and boosted using the ISOBUS Operation screen on the UT. Boosting can also be controlled using the Vehicle view screen

- Up to five (5) target rates can be established

## Color Range Selection

Product options configure maximum/minimum rate limits and corresponding display colors for mapping.



- Press SYSTEM SETUP bottom tab .
- Press CONFIGURATION side tab .
- Press **Product**.
- Select:
  - ▶ Color Range – mode used to set the rate for Maximum rate color and Minimum rate color.
    - ◀ Automatic – maximum and minimum will be determined by actual applied rate values or target rate values
    - ◀ Manual – maximum and minimum limits will be set to those set in Applied rate mapping upper limit and Applied rate mapping lower limit options
  - ▶ Maximum Rate Color – used to set the color for the maximum rate. When in Manual Color Range mode, this color will be used for all rates above the Applied Rate Mapping Upper Limit
  - ▶ Minimum Rate Color – used to set the color for the minimum rate. When in Manual Color Range mode, this color will be used for all rates below the Applied Rate Mapping Lower Limit

Figure 19: Product Options



# Aeros 9040 Field Computer

## INFORMATION ON GUIDANCE MODES

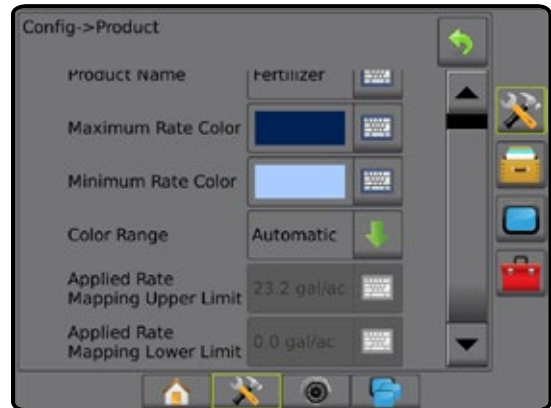
### On screen guidance

- Guidelines
  - ◀ Orange – active guidance line
  - ◀ Black (multiple) – adjacent guidance lines
  - ◀ Black – exterior boundary line
  - ◀ Gray – interior boundary line
  - ◀ Blue – polygon boundary line
  - ◀ Black/white – prescription map zone boundary line
- Points – markers for established points
  - ◀ Red point – Return to Point
  - ◀ Blue point – Mark A
  - ◀ Green point – Mark B
- Horizon compass – general heading can be displayed on horizon (when zoomed in)
- Coverage area – illustrates applied area and overlap:
  - ◀ Blue – one application
  - ◀ Red – two or more applications
  - ◀ User selected – Application map and Target rate map applied areas show colored bars relative to selected color range and map selection.
- Sections
  - ◀ Empty boxes – inactive sections
  - ◀ White boxes – active sections

### Vehicle View

 Vehicle View creates a computer-generated image of the vehicle position displayed in the application area. From this screen all setup, boundary, polygon, mapping, application and navigation options can be accessed via the options tabs on the right side of the screen.

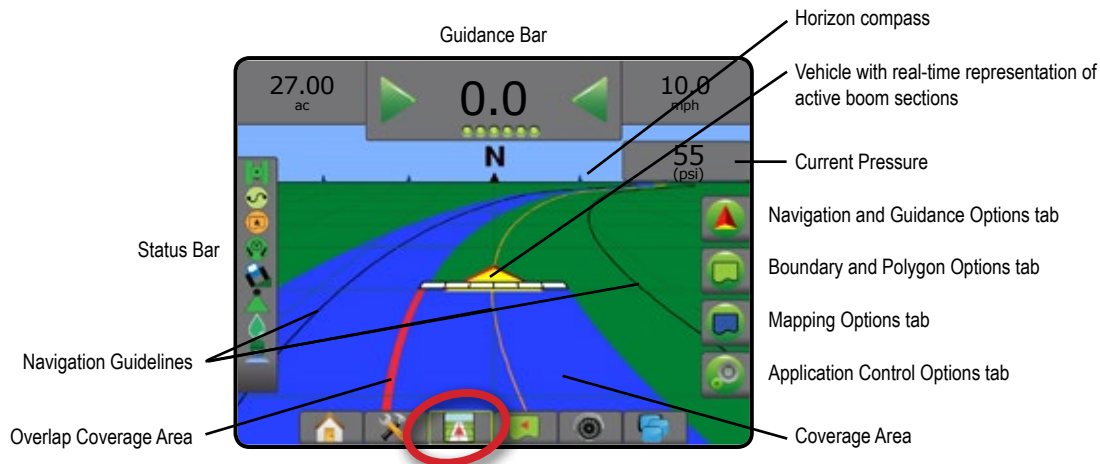

### Field View

 Field View creates a computer-generated image of the vehicle position and application area from an aerial perspective. From this screen, all setup, boundary, polygon and navigation options, as well as Pan mode and mapping options, can be accessed via the option tabs on the right side of the screen.

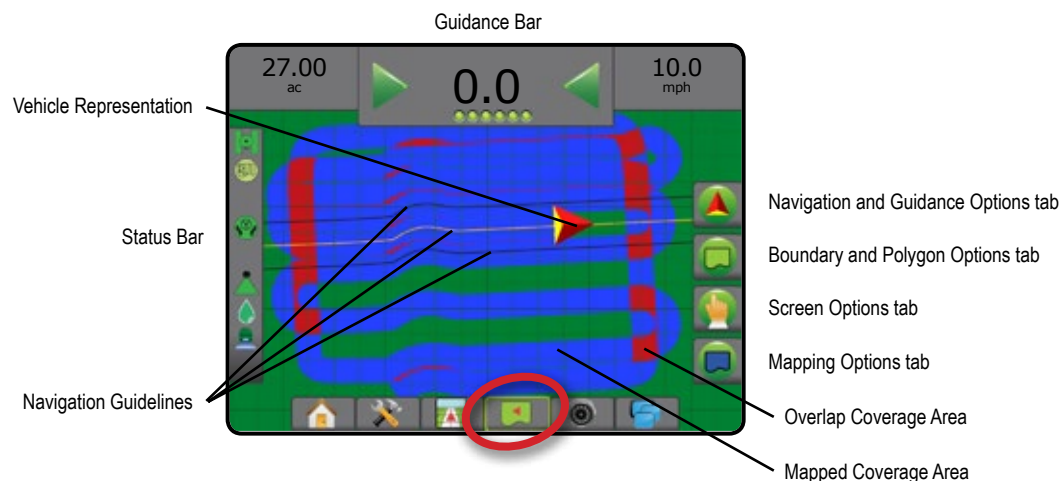



## RealView Guidance

RealView guidance allows live video input to be displayed instead of a computer-generated image. From this screen all setup, boundary, polygon and navigation options can be accessed via the tabs on the right side of the screen. To adjust the camera view [reverse, upside down], go to Setup-> Configuration-> Video.

- ▶ Single Camera – a single camera is directly attached to the console
- ▶ Video Selection Module – if a Video Selection Module (VSM) is installed on the system, two (2) video options are available:
  - One camera view – one of up to eight camera inputs can be selected to change the view of the video input.
  - Split camera view – one of two sets of four camera inputs (A/B/C/D or E/F/G/H) can be selected to divide the screen into four separate video feeds.

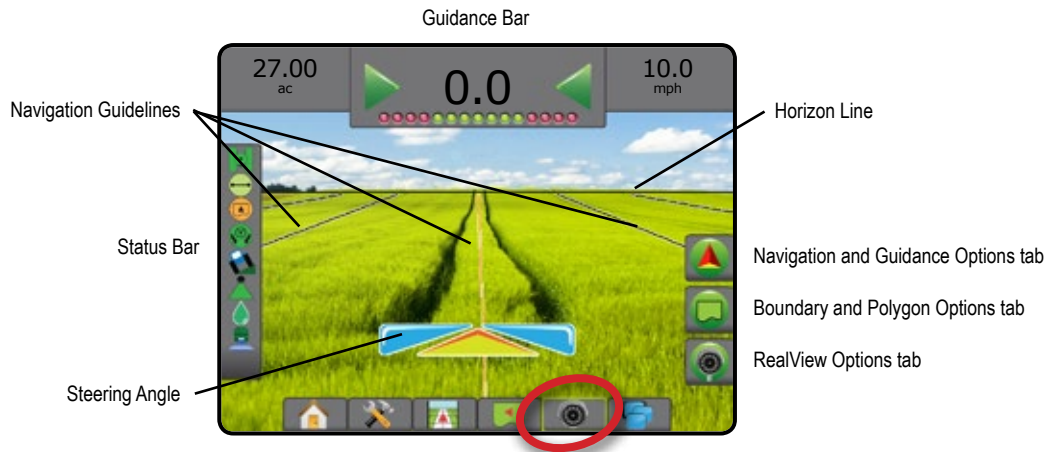





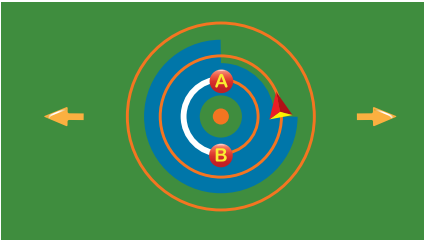

## GUIDANCE MODES

	<h3>Straight AB Guidance</h3> <p>Straight AB guidance provides straight-line guidance based on A and B reference points. The original A and B points are used to calculate all other parallel guidelines.</p> <p><i>NOTE: Offset to adjacent guidelines will be calculated using the guidance width: see "Configuration-&gt; Mapping and guidance" in the System setup chapter.</i></p>	
	<h3>Curved AB Guidance</h3> <p>Curved AB guidance provides guidance along curved lines based on an initial AB reference line. This initial baseline is used to calculate all other guidelines.</p> <p><i>NOTE: Curved guidance is recommended not to exceed 30° within the AB guideline.</i></p> <p><i>Offset to adjacent guidelines will be calculated using the guidance width: see "Configuration-&gt; Mapping and guidance" in the System setup chapter.</i></p> <p><i>HINT: While working in a bounded area, the guidance pattern extending beyond the established AB points will be straight-line guidance.</i></p>	
	<h3>Adaptive Curve AB Guidance</h3> <p>Adaptive Curve guidance* provides guidance along a curved line based on an initial AB reference line where each adjacent guideline is drawn from the projected guidance width and heading.</p> <p><i>NOTE: Offset to adjacent guidelines will be calculated using the guidance width: see "Configuration-&gt; Mapping and guidance" in the System setup chapter.</i></p>	

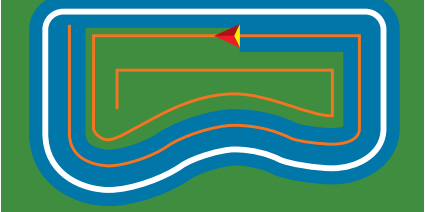

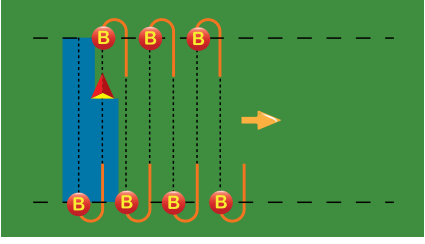
# Aeros 9040 Field Computer

	<h3>Circle Pivot Guidance</h3> <p>Circle Pivot guidance provides guidance around a central location that radiates inward or outward based on an initial AB reference line. This initial baseline is used to calculate all other guidelines.</p> <p>It is used for product application in a center pivot field while being guided along a circular guideline that matches a center pivot irrigation system radius.</p> <p><i>NOTE: Offset to adjacent guidelines will be calculated using the guidance width: see "Configuration-&gt; Mapping and guidance" in the System setup chapter.</i></p>	
	<h3>Last Pass Guidance</h3> <p>Last Pass guidance* offers true last-pass navigation. The console will automatically detect the nearest applied area and establish parallel guidelines based on that area.</p> <p><i>NOTE: If a boundary is established but no application occurred during the boundary process, guidance will not initiate.</i></p>	
	<h3>NextRow Guidance</h3> <p>NextRow guidance* indicates where the NextRow is located, and provides guidance at row ends to the next adjacent row. When the operator marks the end of the row and begins turning to the next row, a Straight AB guidance line is provided in the next row. When the vehicle is in the NextRow, guidance is turned off.</p> <p><i>NOTE: Offset to NextRow will be calculated using the guidance width: see "Configuration-&gt; Mapping and guidance" in the System setup chapter.</i></p> <p><i>The NextRow Guidance does not support skipping rows.</i></p>	
	<h3>No Guidance</h3> <p>No guidance* turns off guidance.</p> <p><i>NOTE: No guidance mode does not delete established guide lines or points from the console. To delete established/saved data from the console, see "Data management" in the System setup chapter.</i></p>	

\*Guidance options may not be available depending on assisted/automatic steering system installed.

Adjacent rows may be skipped in Straight AB guidance, Curved AB guidance, Adaptive Curve guidance and Circle Pivot guidance. Last Pass guidance and NextRow guidance do not support skipping adjacent rows.

## SCREENS OPTIONS

Guidance and navigation can be accessed from the Vehicle View screen, Field View screen, or RealView screen.







- Navigation and Guidance Options tab  – on any guidance screen, displays navigation options including guidance modes, guideline options, return to point options, refresh GNSS, BoomPilot toggle, curved lookahead toggle and Tip Flow Monitor reset.
- Boundary and Polygon Options tab  – on any guidance screen, displays exterior boundary, interior boundary and polygon options.
- Mapping Options tab  – on Vehicle View or Field View guidance screens, displays polygon maps, coverage maps and application maps.
- Application Options tab  – on Vehicle View guidance screen, displays ISOBUS Sprayer application options.
- Screen Options tab  – on Field View guidance screen, displays zoom and pan options.
- RealView Options tab  – on RealView guidance screen, displays camera setup and guidance over video options.

Figure 20: Guidance Screen Options







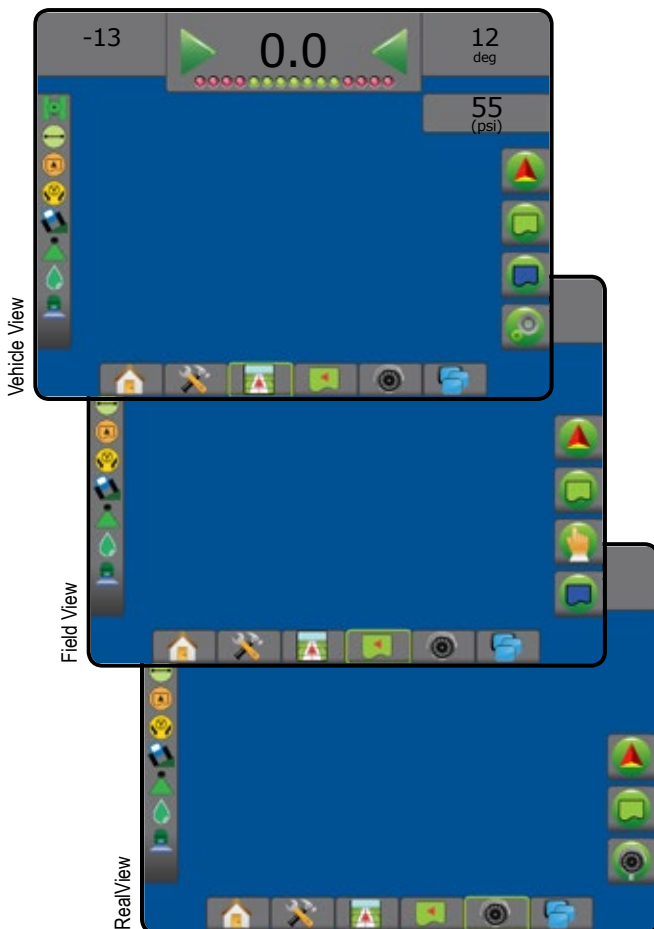
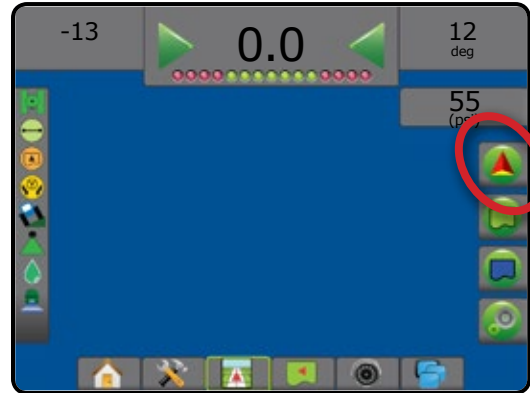









### Navigation and Guidance Options

On any guidance screen, displays navigation options including guidance modes, guideline options, return to point options, refresh GNSS, BoomPilot toggle, curved lookahead toggle and Tip Flow Monitor reset.



#### Guidance Mode

	Guidance Mode – access to guidance mode options
	No guidance – turns off guidance
	Straight AB guidance  – provides straight-line guidance based on A and B reference points
	Curved AB guidance  – provides guidance along curved lines based on an initial AB reference line
	Circle Pivot guidance  – provides guidance around a central location that radiates inward or outward based on an initial AB reference line
	Last Pass guidance  – offers true last-pass navigation
	NextRow guidance  – indicates where the NextRow is located, and provides guidance at row ends to the next adjacent row
	Adaptive Curve guidance  – provides guidance along a curved line based on an initial AB reference line where each adjacent guideline is drawn from the projected guidance width and heading















#### BoomPilot

	Toggles the Automatic Section Control (ASC) on or off. Grayed = GNSS is unavailable.
---	--





#### Curved Lookahead

	Indicates where the current steering will take the vehicle using a 'pointer' as guidance.
---	---

## Guidelines

	Mark A  – marks the first point of the guideline.
	Mark B  – marks the end point of the guideline. Grayed = minimum distance has not been travelled.
	Cancel mark A – cancels the Mark A process. Reverts to previous AB guideline (when established).
	NextRow mark B  – marks the end point of the row.
	Azimuth Degree  – establishes a straight guideline measured by degrees clockwise from a north-south baseline. North = 0, East = 90, South = 180, West = 270.
	A+ Nudge – shifts the existing guideline to the vehicle's current position.
	Next Straight Guideline – shows the next straight AB or Azimuth Degree guideline saved in the current job.
	Next Curved AB Guideline – shows the next Curved AB guideline saved in the current job.
	Next Circle Pivot Guideline – shows the next Circle Pivot AB guideline saved in the current job.
	Next Adaptive Curve Guideline – shows the next Adaptive Curve AB guideline saved in the current job.

## Return to Point

	Mark point  – establishes a point at the vehicle location. Grayed = GNSS is unavailable.
	Return to Point guidance – provides distance and guidance back to an established point.
	Delete point – deletes the Marked Point.
	Cancel guidance – hides the distance and guidance back to the marked point.

## Tip fault reset

	Clears any tip fault indications.
---	-----------------------------------

## Refresh GNSS position

	Resets the ClearPath filter in the OEMStar receiver.
---	--







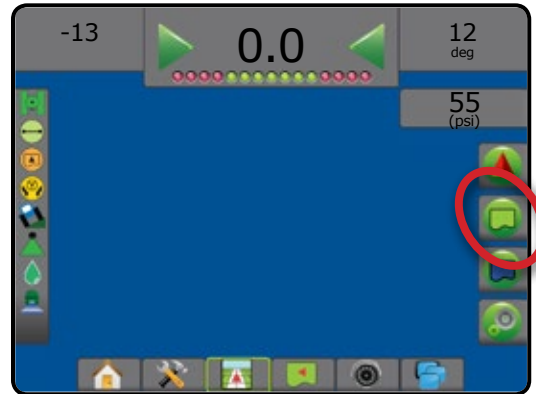

## Boundary and Polygon Options



On any guidance screen, displays exterior boundary, interior boundary and polygon options.











## Exterior boundaries

	Mark exterior boundary – establishes application area and determines no-apply zones. While creating an exterior boundary, the boundary line will be to the exterior of the outer-most section. Grayed = GNSS is unavailable.
	Cancel exterior boundary – cancels mark exterior boundary process
	Finish exterior boundary – finalizes current mark exterior boundary process. Boundaries can also be closed by travelling to within a swath width of the starting point.
	Pause exterior boundary – pauses the mark exterior boundary process
	Resume exterior boundary – resumes the mark exterior boundary process
	Delete last marked boundary – deletes the last marked boundary (interior or exterior) from the current job. Press again to remove additional boundaries in order from last to first created

## Interior boundaries

	Mark interior boundary – establishes application area and determines no-apply zones. While creating an interior boundary, the boundary line will be to the interior of the inner-most section. Grayed = GNSS is unavailable.
	Cancel interior boundary – cancels current mark interior boundary process
	Finish interior boundary – finalizes current mark interior boundary process. Boundaries can also be closed by travelling to within a swath width of the starting point

	Pause interior boundary – pauses the mark interior boundary process
	Resume interior boundary – resumes the mark interior boundary process
	Delete last marked boundary – deletes the last marked boundary (interior or exterior) from the current job. Press again to remove additional boundaries in order from last to first created









Polygons	
	Mark polygon – establishes mapping areas. Grayed = GNSS is unavailable.
	Cancel polygon – cancels current mark polygon process
	Finish polygon – finalizes current mark polygon process
	Pause polygon – pauses the mark polygon process
	Resume polygon – resumes the mark polygon process
	Delete last marked polygon – deletes the last marked polygon from the current job. Press again to remove additional polygons in order from last to first created

## Mapping Options

On Vehicle View or Field View guidance screens, displays polygon maps, coverage maps and application maps.

*NOTE: Options are available only when a rate controller is on the system or a polygon has been established.*







	Coverage map – shows areas covered by the implement, regardless of whether product was applied.	
	Polygon map – shows all mapped polygons	
	Prescription map – shows pre-loaded map that provides information to the rate controller for use in applying product	
	Application map – shows where product has been applied, using color to indicate level in proportion to preset maximum and minimum levels	
	Target rate map – shows the application rate that the rate controller will attempt to achieve	
	Vehicle View – icons adjust the vehicle's view or perspective to the horizon from Vehicle View to bird's-eye view.	
	Field View – icons increase/decrease the area displayed on the screen.	

## Application Control Options

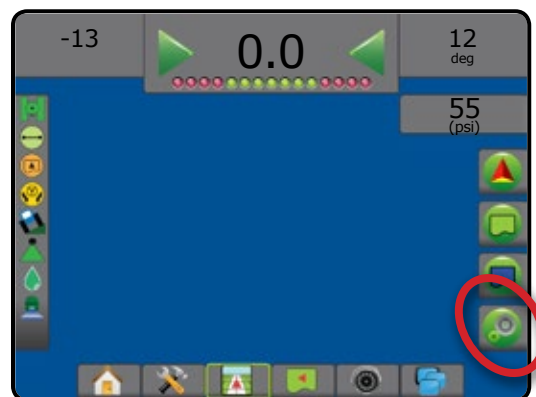
On Vehicle View guidance screen, displays ISOBUS Sprayer application options.

*NOTE: Options are available only when a ISOBUS Sprayer rate controller is on the system.*



	Target rate percentage increase – establishes the required boost percentage step increase
	Target rate percentage decrease – establishes the required boost percentage step decrease
	Percentage boost and reset – shows current boost percentage step and when pressed, zeros the boost percentage step

# Aeros 9040 Field Computer

## Screen Options

On Field View guidance screen, displays zoom and pan options.

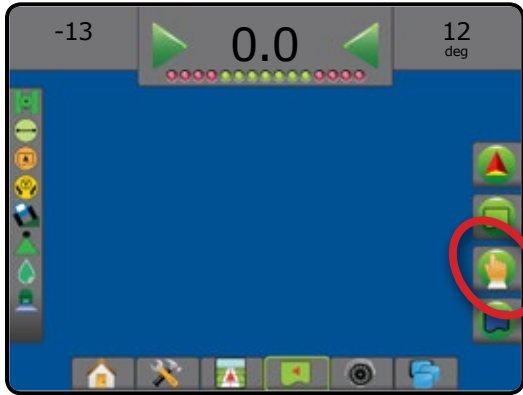



## RealView Guidance Options

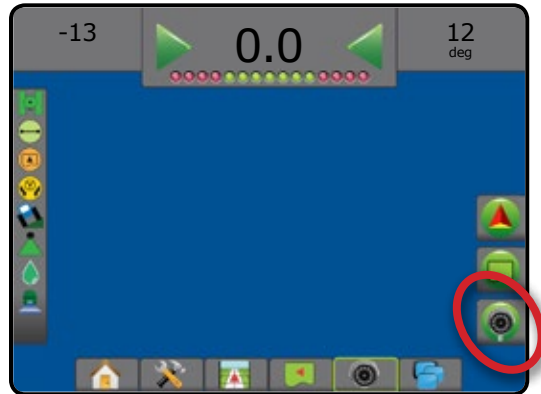

On RealView guidance screen, displays camera setup and guidance over video options.









### Zoom In/Out

	Vehicle View – icons adjust the vehicle's view or perspective to the horizon from Vehicle View to bird's-eye view.	
	Field View – icons increase/decrease the area displayed on the screen.	

### Pan

	Arrows – move the displayed map area in the corresponding direction without moving the vehicle.
	World View – extends the screen view to the widest area available.

	Video camera select – selects one of up to eight camera views if a Video Selection Module (VSM) is attached.
	Split camera view – selects one of two sets of four camera inputs (A/B/C/D or E/F/G/H) to divide the screen into four separate video feeds.
	Guidance Over Video setup – access to turn on Guidance Over Video or Steering angle and adjust guidelines.
	Guidance Over Video – places three-dimensional guidelines over the video feed for navigational assistance.
	Steering angle – displays the direction in which the steering wheel needs to be adjusted.
	Up & down icons – used to adjust the guidance lines and horizon line to match the camera's view.
	Camera image capture – saves a still photo of the current view on the screen to a USB drive.



## GUIDANCE BAR

The Guidance bar keeps you informed of your choice of selectable information, navigation activity, and section status.

### Navigation Activity & Boom Status

GNSS Status – displays “No GNSS” when GNSS is unavailable, or “Slow GNSS” when GNSS is receiving GGA data at less than 5Hz

Cross Track Error – displays the distance from your desired guideline.

The distance around the guideline that is perceived as zero error can be adjusted using Configuration-> Guidance-> Guidance Sensitivity.

To change the format in which the distance is displayed:

1. Press the Navigation Activity box on the guidance bar.
2. Select the measurement format.

Current Activity – displays activities such as mark an A or B point, approaching the end of a row, indicating to turn now, and distance to return to a marked point

Section Status – one dot is displayed for each section programed: a green dot indicates the section is active, and a red dot indicates the section is not active



### Selectable Information

Speed – displays the current speed of travel

Heading – displays the course of travel based clockwise from a true north baseline. North = 0°, East = 90°, South = 180°, West = 270°.

Total Applied Area – displays the total accumulated area that has had product applied, including double-coverage areas

Application Time – displays the total time application is active during the current job

Time – displays the current time based on the selected time zone

Swath Number – displays the current swath number in reference to the initial AB guidance line, facing in the direction from A to B. Number will be positive when the vehicle is to the right of the AB baseline, or negative when the vehicle is to the left of the AB baseline.

System Pressure – displays the current system pressure (available only when an Input/Output Module or Dual Control Module with an active pressure sensor is on the system)

Droplet Size – displays the current tip droplet size (available only when an Input/Output Module or Dual Control Module with an active pressure sensor is on the system)

Actual Application Rate – displays the current application rate (available only when a rate controller is on the system)

Target Application Rate – displays the target application rate (available only when a rate controller is on the system)

Volume/Product Applied – displays the volume or weight of product applied (available only when a rate controller is on the system)

Tank/Bin Amount Remaining – displays the volume or weight of product remaining in the tank/bin (available only when a rate controller is on the system)



## STATUS BAR

The Status bar provides information on GNSS status, guidance mode, exterior boundary area, assisted/auto steering engagement, tilt correction, implement control status, droplet/pressure status, and tip flow status.

When an icon is pressed, the related status information is displayed.

Figure 21: Status Bar

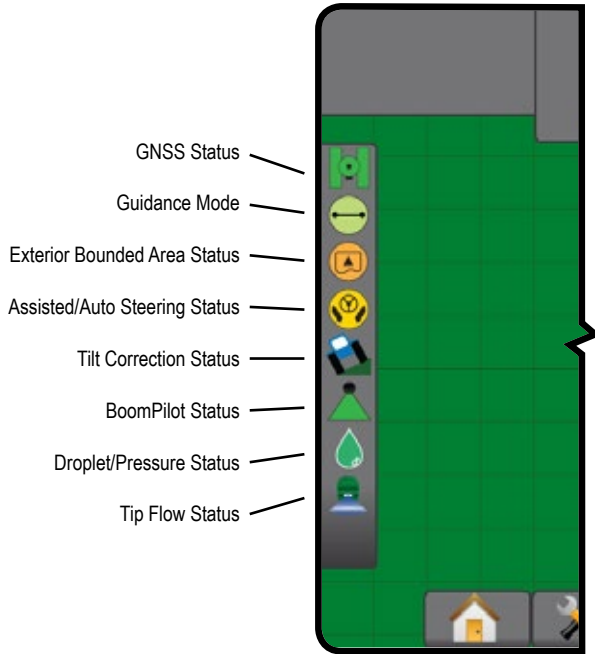

### Bounded Area Status

- Outside Exterior Boundary = traveling outside exterior bounded area
- Inside Exterior Boundary = traveling inside exterior bounded area
- No icon = no boundary established (exterior or interior)

### Assisted/Auto Steering Status

- Green = engaged, actively steering
- Yellow = enabled, all conditions have been met to allow for assisted/auto steering
- Red = disabled, all conditions have not been met to allow for assisted/auto steering
- No icon = no assisted/auto steering system installed

### Tilt Correction Status

- Colored = engaged, actively applying tilt correction
- Red = disabled
- No icon = no tilt gyro module installed on system, or tilt is associated with assisted/auto steering system

### BoomPilot Status

- Green = automatic
- Yellow = all on
- Red = off/manual
- No icon = single section (no SmartCable or SDM installed on system)

### Droplet/Pressure Status

- Colored = engaged. The color of the droplet is directly associated with the current droplet size. Color options include:
- Crossed out = disabled
- No icon = no Pressure sensor interface kit installed, no pressure sensor monitor on the DCM

### Tip Flow Status

- Green = tip flow system calibrated with no tip errors
- Red = tip flow imbalance: flow is higher or lower than the tip alarm threshold
- No icon = no Tip Flow Monitor hardware detected

### GNSS Status

- Green = GPS, GLONASS, or SBAS (with or without DGPS Required)
- Yellow = GPS only
- Red = no GNSS
- Orange = Glide/ClearPath

### Guidance Mode

- No icon = no guidance
- Straight AB Guidance
- Curved AB Guidance
- Circle Pivot Guidance
- Last Pass Guidance
- Nextrow Guidance
- Adaptive Curve Guidance



## GUIDANCE FEATURES DETAILS

### A+ Nudge Feature

**A+** The A+ Nudge feature allows the current guideline to be shifted to the vehicle's current location.

*NOTE: Available only when in Straight AB or Curved AB guidance.*

To adjust the guideline:

1. Press NAVIGATION AND GUIDANCE OPTIONS tab  to display navigation options.
2. Press A+ NUDGE icon .

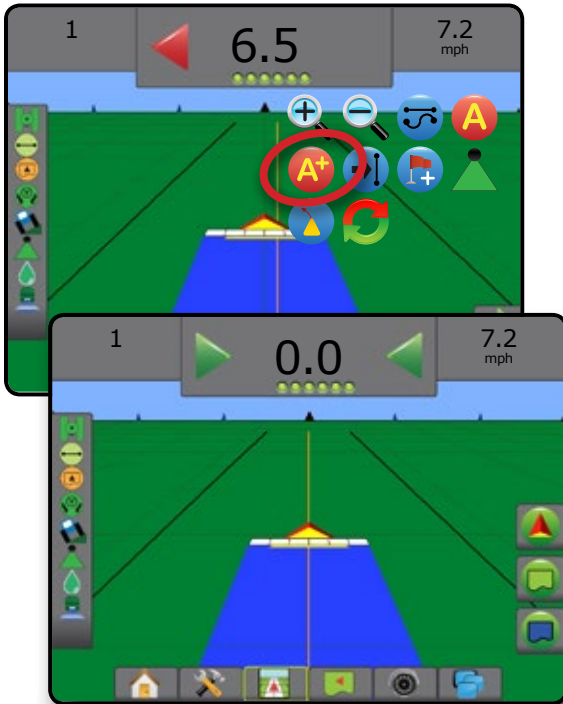



### Azimuth Degree

**A↑** An azimuth is defined as a horizontal angle measured clockwise from a true north baseline. When using an azimuth, the point from which the azimuth originates is the center of an imaginary circle. North = 0°, East = 90°, South = 180°, West = 270°.

Azimuth Degree guidance projects a guideline between the current vehicle position (the A point) and a B point set 100 meters away along the entered azimuth heading.

To establish an Azimuth Degree guideline:

1. Press NAVIGATION AND GUIDANCE OPTIONS tab  to display navigation options.
2. Press AZIMUTH icon  to enter azimuth degree.
3. Use the entry screen to establish the azimuth degree.
4. "Would you like to name this guideline?"  
Press:
  - ▶ Yes – to enter a name and save the guideline
  - ▶ No – to automatically generate a name

The console will begin providing navigation information.

To establish additional azimuth guidelines, follow the same steps as the initial azimuth guideline.



# Aeros 9040 Field Computer

## Return to Point



Return to Point provides guidance back to an established point in Vehicle View and Field View. In Vehicle View an arrow directs the vehicle back to the established point. In Field View only the point is displayed.

A return point is job-specific, and will remain active in the active job until canceled.

*NOTE: Return to Point guidance may not be available depending on assisted/automatic steering system installed.*

## Marking a Return Point

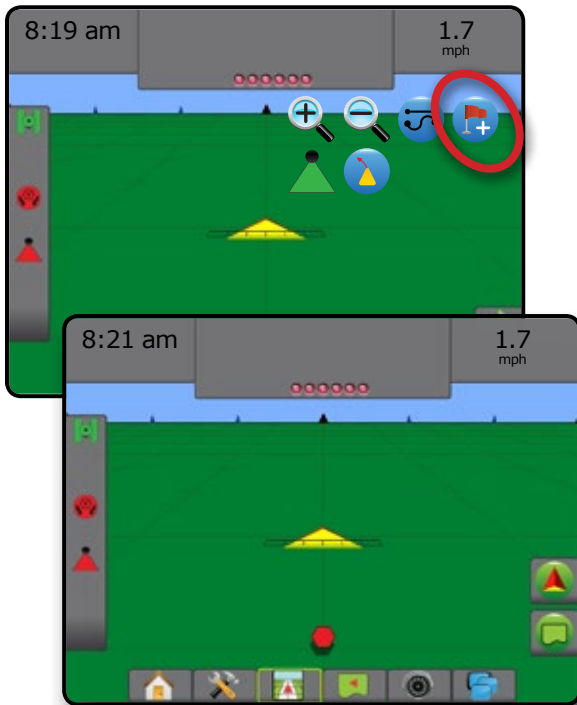

To mark a return point:

1. Drive to the desired location of return point .
2. Press NAVIGATION AND GUIDANCE OPTIONS tab  to display navigation options.
3. Press ADD POINT icon .



## Delete the Return Point

To delete the established return point:

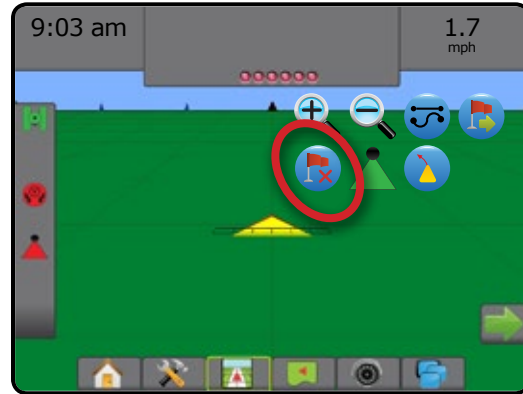

1. Press NAVIGATION AND GUIDANCE OPTIONS tab  to display navigation options.
2. Press DELETE POINT icon .

Delete Point icon is not available while return to point guidance is active.



## Guidance to a Return Point

To show distance and guidance to the established return point:

1. Press NAVIGATION AND GUIDANCE OPTIONS tab  to display navigation options.
2. Press the RETURN TO POINT GUIDANCE icon .

The console will begin providing the distance information on the Guidance bar from the vehicle to the established point.





Use CANCEL RETURN TO POINT GUIDANCE icon  to hide distance and guidance to the established point.

Guidance cannot be calculated when "?" appears in the guidance bar.







## Next Guideline Feature





If more than one guideline is saved, the Next Guideline Feature will become available. By pressing the Next guideline option, the vehicle will be directed to the next guideline saved in the console.

- Next Straight Guideline  – shows the next straight AB or Azimuth Degree guideline saved in the current job.
- Next Curved AB Guideline  – shows the next Curved AB guideline saved in the current job.
- Next Circle Pivot Guideline  – shows the next Circle Pivot AB guideline saved in the current job.
- Next Adaptive Curve Guideline  – shows the next Adaptive Curve AB guideline saved in the current job.

*NOTE: Offset to adjacent guidelines will be calculated using the guidance width. See “Configuration->Mapping and guidance” in the System setup chapter.*

To change to other available guidelines:

1. Press NAVIGATION AND GUIDANCE OPTIONS tab  to display navigation options.
2. Press NEXT GUIDELINE icon    .

Toggle between all guidelines by pressing the NEXT GUIDELINE icon     again.

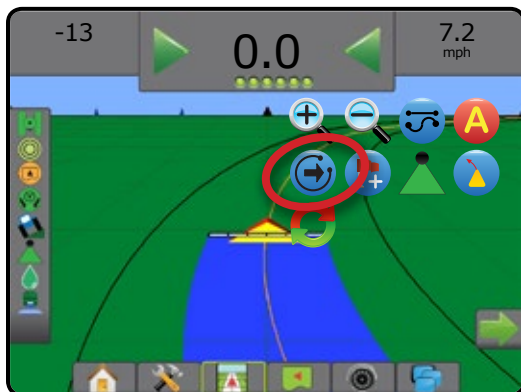

To view which guideline is active, press the Guidance mode icon on the Status bar.

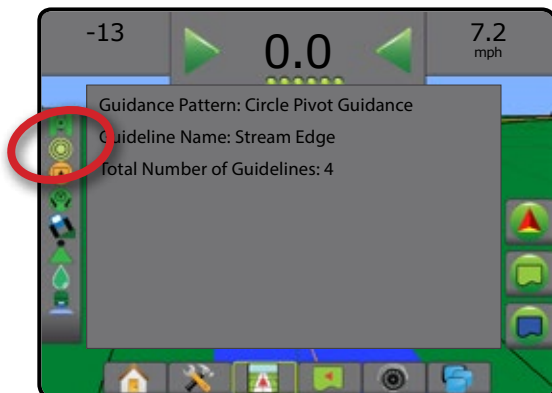



## REFRESH GNSS POSITION

Refresh GNSS position resets the ClearPath filter in the OEMStar receiver in cases where the user has had the receiver running in close proximity to heavy tree cover and/or buildings. See “Configuration->GNSS Receiver Configuration” to activate the Refresh GNSS position icon.

*NOTE: Activating the refresh while in a job will cause a momentary interruption in the relay of GNSS data. This will most likely result in sections already on in automatic BoomPilot mode to go off for a short period of time.*

*The refresh should not be done during active application.*

To refresh the GNSS position:

1. Press NAVIGATION AND GUIDANCE OPTIONS tab  to display navigation options.
2. Select Refresh GNSS POSITION icon .

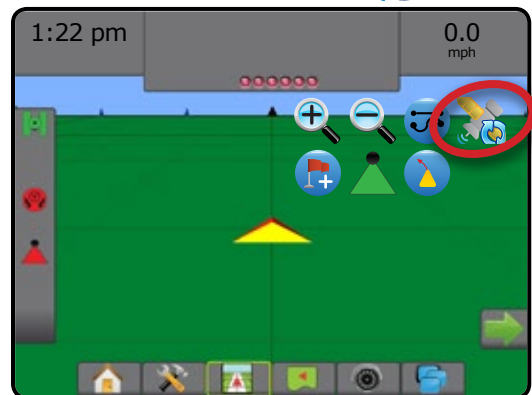



## BOOMPILOT

Depending on if there is a section control system present and when present what kind of section control is being used as well as what options are enabled, there are multiple options for BoomPilot section control.

This section includes setup options for these configurations:

- ▶ No Section Control Module
  - Console only
  - With optional work on/off switch
- ▶ ISOBUS sprayer
  - Console and ECU only
  - With switchbox
  - With an ISOBUS Implement Status Module (ISO ISM)
- ▶ ISOBUS spreader
  - Console only
  - With optional spreader on/off switch
- ▶ With TeeJet Section Control Module and switchbox or ISM
- ▶ With TeeJet Section Control Module

Figure 22: BoomPilot icon and Status bar indicator

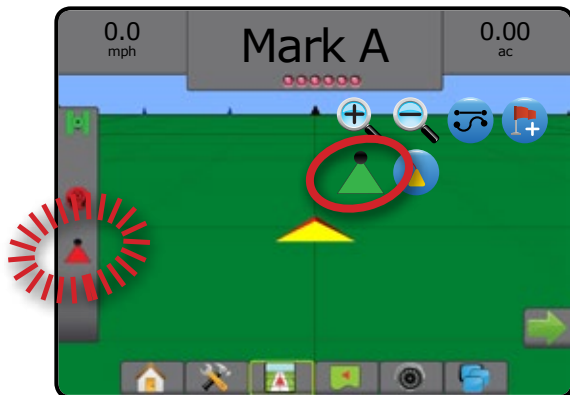

### No Section Control Module

If a section control system is not present, the BoomPilot icon or an optional work on/off switch is used to turn the single section on or off. Only one section width will be illustrated and the status bar will have no icon.

*NOTE: If an ISOBUS controller, SmartCable, Section Driver Module (SDM), or Switch Function Module (SFM) is present, please refer to the following sections for more information.*

*NOTE: The BOOMPILOT icon is gray when GNSS is unavailable.*

### Console Only

The BoomPilot icon is used to turn the section on or off.

To set configuration settings:

1. Press SYSTEM SETUP bottom tab
2. Press CONFIGURATION side tab
3. Press **Implement**.
4. Set "BoomPilot icon" to **Enable**.

*NOTE: BoomPilot start mode setting will make no difference in the function of this option.*

To switch application off or on using the console:

1. Press NAVIGATION AND GUIDANCE OPTIONS tab
2. Press BOOMPILOT icon
3. Press BOOMPILOT icon to toggle the section on or off.

### ISOBUS Sprayer

If an ISOBUS Electronic Control Unit (ECU) is present, the BoomPilot icon or an optional switchbox can be used to turn the boom on or off. The BoomPilot icon may also be used to set automatic section control to manual or automatic . The number of section widths displayed will depend on the ISOBUS ECU configuration.

*NOTE: The BOOMPILOT icon is gray when GNSS is unavailable.*

### Console and ECU Only

All ISOBUS rate control configurations should be setup before starting BoomPilot. Automatic or manual regulation mode should not affect the following options.

To set configuration settings:

1. Press SYSTEM SETUP bottom tab
2. Press CONFIGURATION side tab
3. Press **Implement**.
4. Set "BoomPilot icon" to **Enable**.





*NOTE: BoomPilot start mode setting will make no difference in the function of this option.*

To switch application off or on automatically:

1. Press NAVIGATION AND GUIDANCE OPTIONS tab
2. Press BOOMPILOT icon .
  - ◀Automatic – status bar icon will change to green

*NOTE: Application can be manually controlled while in Automatic BoomPilot mode using the Start/stop key on the ISOBUS Operation screen.*



To switch application off or on manually:

1. Press NAVIGATION AND GUIDANCE OPTIONS tab  to display navigation options.
2. Press BOOMPILOT icon .
  - ◀Automatic – status bar icon will change to red 
3. Press ISOBUS UNIVERSAL TERMINAL bottom tab .
4. Go to the Operation screen
5. Use the START/STOP key .

## With Switchbox



All ISOBUS rate control configurations should be setup before starting BoomPilot. Automatic or manual regulation mode should not affect the following options.

To set configuration settings:

1. Press SYSTEM SETUP bottom tab .
2. Press CONFIGURATION side tab .
3. Press **Implement**.
4. Set “BoomPilot icon” to **Disable**.

*NOTE: BoomPilot start mode setting will make no difference in the function of this option.*



To switch application off or on automatically:

1. Switchbox master switch and section switches must be in the “On” positions.
1. Press NAVIGATION AND GUIDANCE OPTIONS tab  to display navigation options.
2. Press BOOMPILOT icon .
  - ◀Automatic – status bar icon will change to green 

*NOTE: Application can be manually controlled while in Automatic BoomPilot mode using the master switch or individual section switches.*

*Caution: With some versions of ISOBUS software, while in a previously applied area, manually changing a section switch will change BoomPilot to manual mode. Therefore, if a switch remained in the on position after exiting the applied area, it would remain off.*



To switch application off or on manually:

1. Press NAVIGATION AND GUIDANCE OPTIONS tab  to display navigation options.
2. Press BOOMPILOT icon .
  - ◀Manual – status bar icon will change to red 
3. Turn master switch or individual section switches On/Off.

## With an ISOBUS Implement Status Module (ISO ISM)



All ISOBUS rate control configurations should be setup before starting BoomPilot. Regulation mode should be “Manual”.

To set configuration settings:

1. Press SYSTEM SETUP bottom tab .
2. Press CONFIGURATION side tab .
3. Press **Implement**.
4. Set “BoomPilot icon” to **Enable**.



*NOTE: BoomPilot start mode setting will make no difference in the function of this option.*

To switch application off or on automatically:



1. Press NAVIGATION AND GUIDANCE OPTIONS tab  to display navigation options.
2. Press BOOMPILOT icon .
  - ◀Automatic – status bar icon will change to green 

*NOTE: Application can be manually controlled while in Automatic BoomPilot mode using the switches connected to the ISO ISM.*

To switch application off or on manually:

1. Press NAVIGATION AND GUIDANCE OPTIONS tab  to display navigation options.
2. Press BOOMPILOT icon .
  - ◀Automatic – status bar icon will change to red 
3. Turn master switch or individual section switches On/Off.

## ISOBUS Spreader



If an ISOBUS Electronic Control Unit (ECU) is present, the BoomPilot icon or an optional remote master switch can be used to turn the application on or off. The BoomPilot icon may also be used to set automatic section control to manual  or automatic .

*NOTE: The BOOMPILOT icon is gray  when GNSS is unavailable.*

## Console Only

All ISOBUS rate control configurations should be setup before starting BoomPilot. Regulation mode should be “Manual”.





To set configuration settings:

1. Press SYSTEM SETUP bottom tab .
2. Press CONFIGURATION side tab .
3. Press **Implement**.
4. Set “BoomPilot icon” to **Enable**.

*NOTE: BoomPilot start mode setting will make no difference in the function of this option.*





# Aeros 9040 Field Computer

To switch application off or on automatically:

1. Press NAVIGATION AND GUIDANCE OPTIONS tab  to display navigation options.
2. Press BOOMPILOT icon .  
◀Automatic – status bar icon will change to green 
3. Press the ISOBUS UNIVERSAL TERMINAL bottom tab .
4. Go to the Operation screen.
5. Use the START/STOP key .

*NOTE: Application can be manually controlled while in Automatic BoomPilot mode using the Start/stop key on the ISOBUS Operation screen.*



To switch application off or on manually:

1. Press NAVIGATION AND GUIDANCE OPTIONS tab  to display navigation options.
2. Press BOOMPILOT icon .  
◀Automatic – status bar icon will change to red 
3. Press ISOBUS UNIVERSAL TERMINAL bottom tab .
4. Go to the Operation screen
5. Use the START/STOP key .

## With Optional Spreader On/Off Switch

All ISOBUS rate control configurations should be setup before starting BoomPilot. Automatic or manual regulation mode should not affect the following options.

To set configuration settings:

1. Press the ISOBUS UNIVERSAL TERMINAL bottom tab .
2. Enable the Remote spread switch.
3. Press SYSTEM SETUP bottom tab .
4. Press CONFIGURATION side tab .
5. Press **Implement**.
6. Set “BoomPilot icon” to **Disable**.

*NOTE: BoomPilot start mode setting will make no difference in the function of this option.*

In areas where application is desired:



1. Turn Spreader on/off switch to the “on” position.

In areas where application is not desired:

1. Turn Spreader on/off switch to the “off” position.

## With TeeJet Section Control Module And Switchbox or ISM

SmartCable, Section Driver Module (SDM) or Switch Function Module (SFM) and a switchbox or Implement Status Module (ISM) is present.

*NOTE: The BOOMPILOT icon is gray  when GNSS is unavailable. BoomPilot status bar icon will be off/manual .*

To switch application off or on automatically:



1. Automatic/manual boom switch must be in the “Auto” position.  
◀Automatic – status bar icon will be green 
2. Master switch and section switches must be in the “On” position.



*NOTE: Application can be manually controlled while in Automatic BoomPilot mode using the switches on the switchbox or switches connected to the ISO ISM.*

To switch application off or on manually:





1. Automatic/manual boom switch must be in the “Manual” position.  
◀Manual – status bar icon will be red 
2. Use the switches on the switchbox or switches connected to the ISO ISM.

## With TeeJet Section Control Module



SmartCable, Section Driver Module (SDM) or Switch Function Module (SFM) is present BoomPilot is used to set automatic section control to off/manual , automatic , or spot application 

*NOTE: The BOOMPILOT icon is gray  when GNSS is unavailable. BoomPilot status bar icon will be off/manual .*

To switch application off or on automatically:

1. Press NAVIGATION AND GUIDANCE OPTIONS tab  to display navigation options.
2. Press and release BOOMPILOT icon .  
◀Enable – status bar icon will change to green   
◀Disable – status bar icon will change to red 





To apply a spot application:

1. Press NAVIGATION AND GUIDANCE OPTIONS tab  to display navigation options.
2. Press and hold BOOMPILOT icon  over area to be applied.  
◀Spot application– status bar icon will change to yellow 

## ADDITIONAL IMPLEMENT OPTIONS

### TIP SELECTION

When the system includes a Pressure Sensor Interface Kit (PSIK), Tip selection is used to select the type of sprayer tip (series and capacity) for determining droplet size information.

1. Press CONFIGURATION side tab .
2. Press **Implement** .
  - ◀ Current tip section is shown in the information box
3. Press Tip selection NEXT PAGE arrow .
4. Select from:
  - ▶ Tip preset 1-5 – selects up to five (5) tips for quick recall, and selected the current tip for determining droplet size information
  - ▶ Current tip – displays the current tip
5. Press RETURN arrow  or CONFIGURATION side tab  to return to the main Configuration screen.

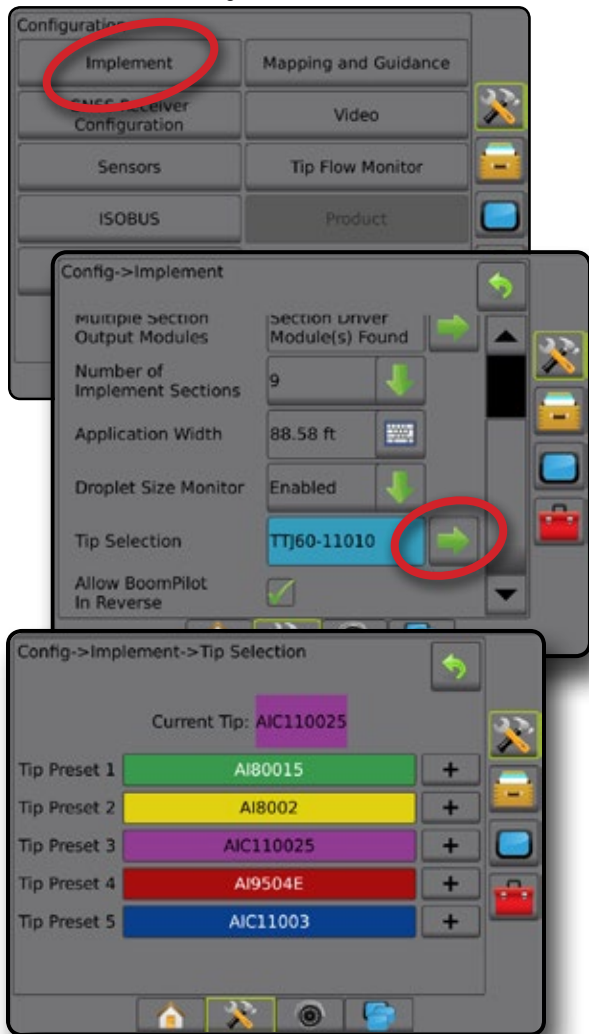

### Preset

Tip presets allow saving of up to five tips for quick recall.

1. Press **+**.
2. Select a TeeJet tip series.
3. Select tip capacity.

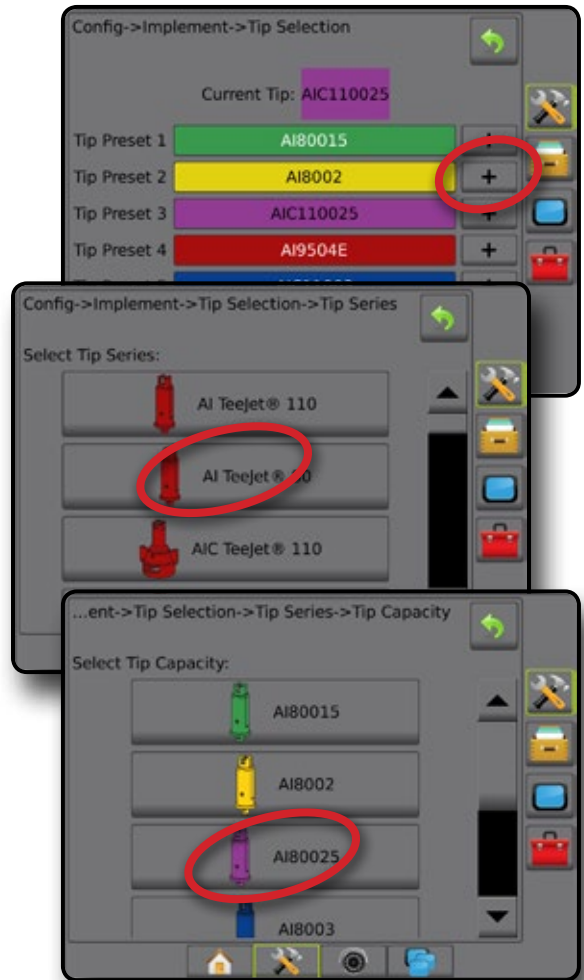

Tip Sizes and Associated Colors

Established Tip Capacities and Colors			
Size	Color	Size	Color
01	Orange	06	Gray
015	Green	08	White
02	Yellow	10	Light Blue
025	Purple	12	Telemagenta
03	Blue	15	Light Green
04	Red	20	Black
05	Brown	30	Beige



## Current Tip

Current tip shows the active tip for determining current droplet size information. Tips must be preset to be available for current tip selection.

1. Press desired tip.

Selected tip will be shown:

- ◀ The information box on the Implement screen
- ◀ The Droplet/pressure status display from the status bar on the guidance screens

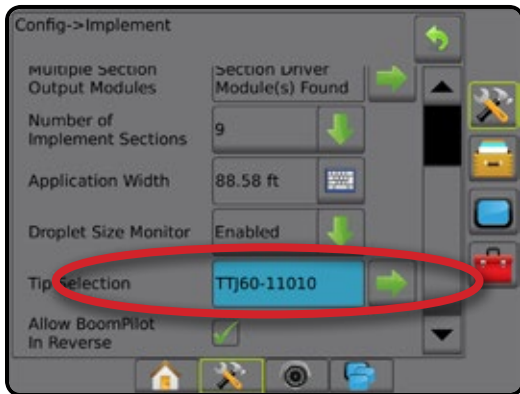
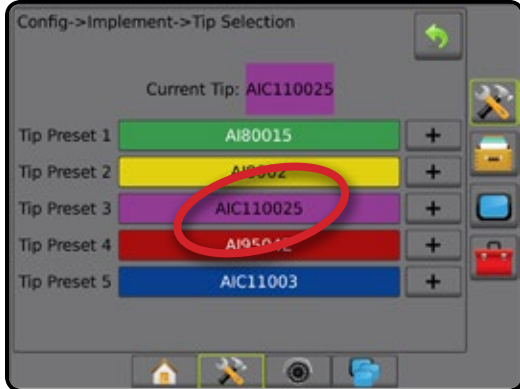

## DROPLET SIZE MONITOR

When the system includes a Pressure Sensor Interface Kit (PSIK), Droplet Size Monitor can be enabled/disabled. The DSM then becomes available on the operation screens.

### Setup

#### Enable/Disable DSM

1. Press CONFIGURATION side tab
2. Press **Implement**.
3. Press **Droplet Size Monitor**.
4. Select if Droplet Size Monitor is enabled or disabled.
5. Press RETURN arrow or CONFIGURATION side tab to return to the main Configuration screen.

*NOTE: When Droplet Size Monitor is disabled, the Droplet/pressure status is not available on the guidance screen status bar.*



### Tip Selection / Current Tip

To establish the tip presets and current tip, see “Tip Selection” in this chapter.

### Input/Output Module Pressure Sensor

When a Pressure Sensor Interface Kit is present, Pressure sensor options are used to enter the sensor manufacturer’s maximum pressure rating and set high and low user determined pressure alarms.



*NOTE: For more information, see “Sensors” in the Setup chapter of this manual.*



## Operation



### Status Bar

Droplet/pressure status displays information regarding the current status of the droplet size and system pressure.

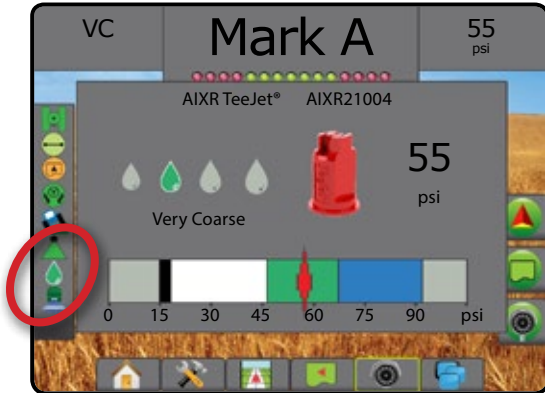
1. Press DROPLET/PRESSURE STATUS icon  .
2. Press the screen anywhere to return to the guidance screen.



### Droplet/Pressure Status

-  Colored = engaged. The color of the droplet is directly associated with the current droplet size. Color options include: 
-  Crossed out = disabled
- No icon = no Pressure Sensor Interface Kit is installed on system

### Droplet Size Chart

When choosing a spray tip that produces droplet sizes in one of the eight droplet size classification categories, always remember that a single tip can produce different droplet size classifications at different pressures. A tip might produce medium droplets at low pressures, while producing fine droplets as pressure is increased.

Category	Symbol	Color Code
Extremely Fine	XF	Violet
Very Fine	VF	Red
Fine	F	Orange
Medium	M	Yellow
Coarse	C	Blue
Very Coarse	VC	Green
Extremely Coarse	XC	White
Ultra Coarse	UC	Black

### Guidance Bar

The Guidance bar keeps you informed of your choice of selectable information including current system pressure and current droplet size.

1. Press SELECTABLE INFORMATION box.
2. Select from:
  - ▶ System Pressure – displays the current system pressure
  - ▶ Droplet Size – displays the current tip droplet size
3. Press outside the selection box to return to the guidance screen.



## REVERSE SENSE

Reverse sense options are used when adding a Reverse Sense Module, SCM (Steering Control Module for FieldPilot IV) or SCM Pro (Steering Control Module Pro for FieldPilot Pro/UniPilot Pro) to any configuration. This allows for application mapping and control, and on-screen guidance when traveling in reverse.

1. Press CONFIGURATION side tab .
2. Press **Implement**.
3. In addition to standard options, select from:
  - ▶ Allow BoomPilot In Reverse – used to enable BoomPilot function while traveling in reverse
  - ▶ Reverse Signal Delay – used to set the delay when going from forward to reverse or reverse to forward, after which the vehicle icon on a navigation screen changes direction

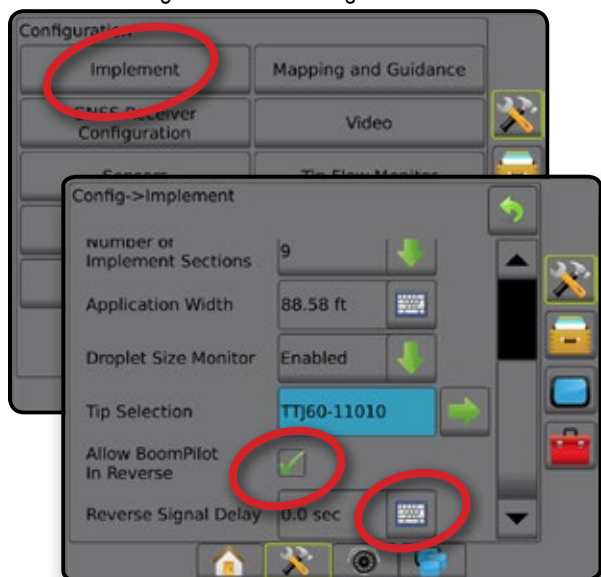

### Reverse on Guidance Screens

While traveling in reverse, having BoomPilot in reverse active allows for product application, automatic section control, and mapping that is correct for reverse machine movement

- ◀ Speed on the Guidance bar will turn red while traveling in reverse

Figure 23: Traveling Forward

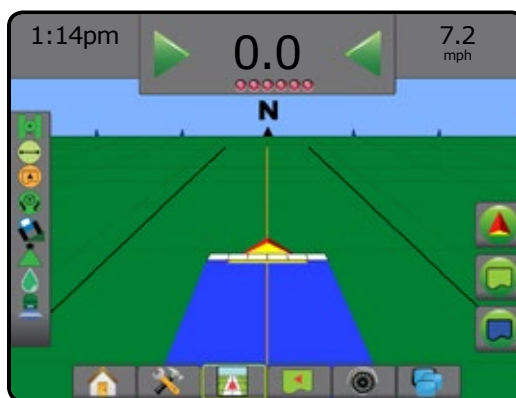
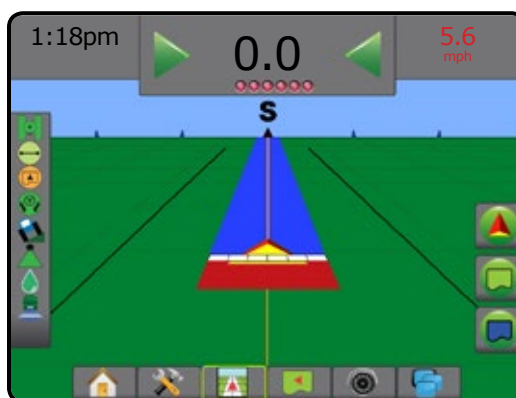

Figure 24: Traveling In Reverse



### Availability with Different System Configurations

Automatic Section Control device on system	Device sensing reverse vehicle movement	BoomPilot in reverse feature available	BoomPilot in reverse can be turned on/off in menu using Allow BoomPilot in Reverse	Signal delay can be adjusted using Reverse Signal Delay
SDM or SFM	FieldPilot IV *	✓	✓	✓
	Reverse Sense Module	✓	✓	✓
	FieldPilot Pro / UniPilot Pro	✓	✓	✗**
IC18 Sprayer or IC34 Sprayer	FieldPilot IV *	✓***	✗	✗
	Reverse Sense Module	✓***	✗	✗
	FieldPilot Pro / UniPilot Pro	✓***	✗	✗**

\* Optional function that is hardware dependent.

\*\* Controlled directly by the FieldPilot Pro / UniPilot Pro.

\*\*\* Aeros consoles shipped from factory have the "Spray in Reverse" disabled by default. For TeeJet ISOBUS Implement ECU's, a USB Drive based settings app is required to change this to enabled, allowing to spray when in reverse.

## BOOMPILOT SECTION CONTROL

Depending on if there is a section control system present and, when present, what kind of section control is being used as well as what options are enabled, there are multiple options for BoomPilot section control. The settings of BoomPilot Start Mode and BoomPilot Icon change how section control is handled on the guidance screens.



1. Press CONFIGURATION side tab .
2. Press **Implement**.
3. Select from:
  - ▶ BoomPilot Start Mode – used to establish if automatic BoomPilot activation is controlled automatically by speed or manually using the BoomPilot Icon in the navigation and guidance options on the guidance screens
    - ◀ Automatic – automatic section control will be controlled by speed
    - ◀ Off – automatic section control is disabled and can be manually controlled by the BoomPilot icon in the navigation and guidance options on the guidance screens
  - ▶ BoomPilot Icon – used to establish if the BoomPilot icon is available in the navigation and guidance options on the guidance screens for manually controlling BoomPilot
    - ◀ Enable – BoomPilot Icon will be available in the navigation and guidance options on the guidance screens to control automatic section control
    - ◀ Disable – BoomPilot Icon will not be available in the navigation and guidance options
4. Press RETURN arrow  or CONFIGURATION side tab  to return to the main Configuration screen.

Figure 25: BoomPilot Options

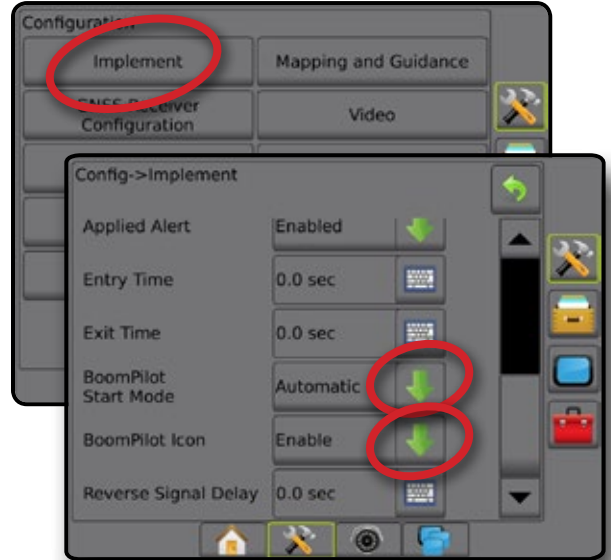

Figure 26: BoomPilot Icon on Guidance Screen



### Availability With Different Hardware Systems

Hardware on System	BoomPilot Start Mode		BoomPilot Icon		
	Available on Configuration-> Implement menu	Works when in guidance screens	Available on Configuration-> Implement menu	Changes what is available on Navigation and guidance options	Works when in guidance screens
SDM/SFM Only (no TeeJet ASB SwitchBox)	Yes	Yes	Yes	Yes	Yes
SDM + TeeJet ASB Switchbox	No	No	No	No	No
SFM + ISM	Yes	Yes	Yes	Yes	Yes
IC18 Sprayer + ISO Switchbox	Yes	Yes	Yes	No, always available	Yes



## TIP FLOW MONITOR

When a Tip Flow Monitor Kit is present, Tip Flow Monitor options are used to configure flow limits and alarm behavior, and to run the tip flow balance process.

*NOTE: For detailed setup instructions, refer to the supplemental Tip Flow Monitor (TFM) guide.*

1. Press CONFIGURATION side tab .
2. Press **Tip Flow Monitor**.
3. Select from:
  - ▶ Tip Alarm Percentage – used to set the error reporting range for the tip sensors
  - ▶ Tip Alarm Delay – used to set the time the console will wait after an error has been encountered before sounding a tip alarm
  - ▶ Number of Sections – used to set the number of sections
  - ▶ Number of Tips per Section – used to enter the number of tips on the specified section
  - ▶ Tip Balance Percentage – used to set the range for balancing tip sensors

*NOTE: The implement must be in a job and all sections must be on to start the tip balance process.*

- ▶ Tip Flow Monitor Balance – used to start the tip flow balance process
4. Press RETURN arrow  or CONFIGURATION side tab  to return to the main Configuration screen.

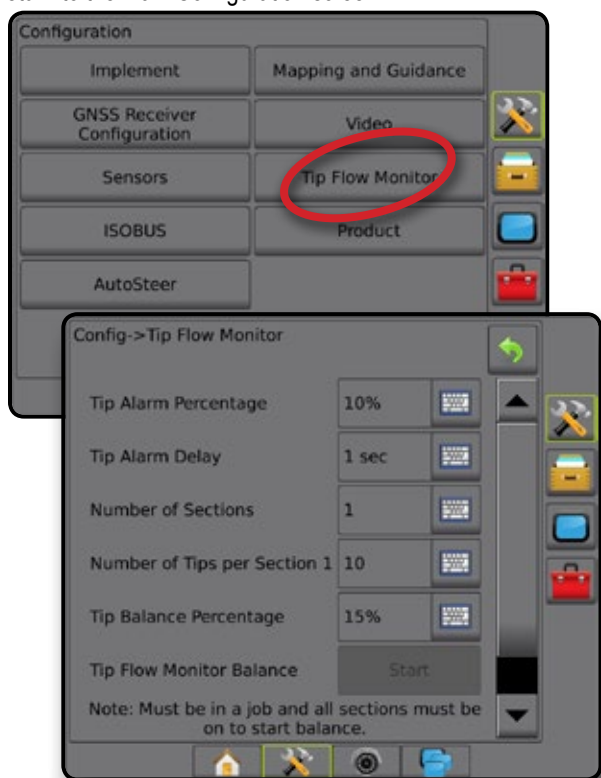

## ISOBUS SPRAYER OFFSETS

Connection point and implement offsets are used to enter the directions and distances from the centerline of the machine to the connection point and implement when Aeros has an ISOBUS Sprayer on the system.

Different machines have different options. The following machines are detailed in this manual. Contact your TeeJet dealer for information on your specific setup or if there are any questions.

- Self-propelled – front mount
- Self-propelled – rear mount
- Three point hitch – front mount
- Three point hitch – rear mount
- Trailed – always rear mount



If using a self-propelled sprayer or spreader, use the GNSS offset adjustment calculation to calculate the implement Lateral Offset Distance adjustment. If using a pull behind or trailed implement, use the Implement offset adjustment calculation to calculate the Implement Lateral Offset Distance adjustment. See the “Implement Lateral Offset Distance Adjustment” section of this chapter for more details.

*Figure 27: Straight Implement Type with ISOBUS Sprayer*



## Self-propelled

### ISOBUS Sprayer Settings:

1. Press UNIVERSAL TERMINAL bottom tab .
2. From the Main setup screen , select **Machine**.
3. Select **OEM** then enter the access code as needed.
4. Select **Implement Geometry**:
5. Establish values for:
  - ▶ Connector type: **Selfpropelled - front** or **Selfpropelled - rear**
  - ▶ B=Section X-offset **4** – measured in parallel to the centerline of the machine, define the distance from the center of the rear axle **B** to the implement

### Aeros Settings:



1. Press SYSTEM SETUP bottom tab .
2. Press CONFIGURATION side tab .
3. Press **Implement**.
4. Select Implement type **Straight**.
5. Press Implement type NEXT PAGE arrow  to set up specific implement options.
6. Establish values for:
  - ▶ Connection Point In-line Offset Direction **1** – define the direction as **Forward** or **Backward** based on ISOBUS Sprayer connection type
  - ▶ Connection Point In-line Offset Distance **1** – measured in parallel to the centerline of the machine, define the distance from the GNSS antenna **A** to the center of the rear axle **B**
  - ▶ Connection Point Lateral Offset Direction **2** – define the direction, either left or right, from the centerline of the machine to the center of the center of the rear axle **B** while facing in the machine's forward direction
  - ▶ Connection Point Lateral Offset Distance **2** – define the distance from the centerline of the machine to the center of the rear axle **B**
  - ▶ Implement In-line Offset Direction **1** – same direction as Aeros Connection Point In-line Offset Direction
  - ▶ Implement In-line Offset Distance **5** – calculated based on Aeros Connection Point In-line Offset Distance **1** and ISOBUS Sprayer B=Section X-offset **4** entries
    - ▶ Front Mount –  $4 - 1 = 5$
    - ▶ Rear Mount –  $1 + 4 = 5$
  - ▶ Implement Lateral Offset Direction **2** – same direction as Aeros Connection Point Lateral Offset Direction
  - ▶ Implement Lateral Offset Distance **2** – same value as on Aeros Connection Point Lateral Offset Distance

Figure 28: Front Mount

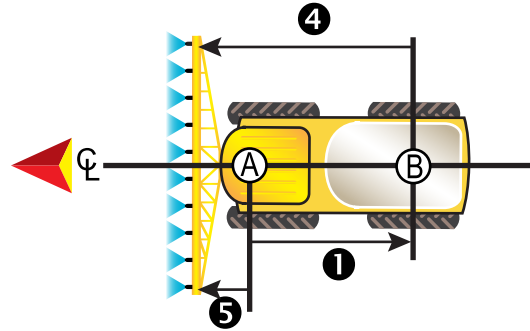
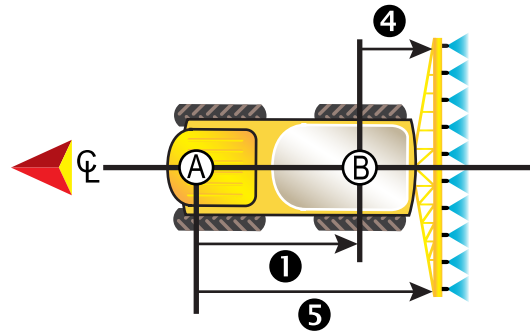



Figure 29: Rear Mount





- A** – Center of the GNSS antenna
- B** – Center of the rear axle
- 1** – Connection Point In-line Offset Direction/Distance
- 2** – Connection Point Lateral Offset Direction/Distance (not illustrated)
- 4** – B=Section X-offset distance
- 5** – Implement In-line Offset Direction/Distance

## Three Point Hitch

### ISOBUS Sprayer Settings:

1. Press UNIVERSAL TERMINAL bottom tab .
2. From the Main setup screen , select **Machine**.
3. Select **OEM** then enter the access code as needed.
4. Select **Implement Geometry**:
5. Establish values for:
  - ▶ Connector type: **3-point hitch - front** or **3-point hitch - rear**
  - ▶ B=Section X-offset **4** – measured in parallel to the centerline of the machine, define the distance from point **B** to the implement

### Aeros Settings:

1. Press SYSTEM SETUP bottom tab .
2. Press CONFIGURATION side tab .
3. Press **Implement**.
4. Select Implement type **Straight**.
5. Press Implement type NEXT PAGE arrow  to set up specific implement options.
6. Establish values for:



- ▶ Connection Point In-line Offset Direction **1** – define the direction as **Forward** or **Backward** based on ISOBUS Sprayer connection type
- ▶ Connection Point In-line Offset Distance **1** – measured in parallel to the centerline of the machine, define the distance from the GNSS antenna **(A)** to point **(B)**
- ▶ Connection Point Lateral Offset Direction **2** – define the direction, either left or right, from the centerline of the machine to the center of point **(B)** while facing in the machine's forward direction
- ▶ Connection Point Lateral Offset Distance **2** – define the distance from the centerline of the machine to point **(B)**
- ▶ Implement In-line Offset Direction **1** – same direction as Aeros Connection Point In-line Offset Direction
- ▶ Implement In-line Offset Distance **5** – calculated based on Aeros Connection Point In-line Offset Distance **1** and ISOBUS Sprayer B=Section X-offset **4** entries
  - ▶ **1 + 4 = 5**
- ▶ Implement Lateral Offset Direction **2** – same direction as Aeros Connection Point Lateral Offset Direction
- ▶ Implement Lateral Offset Distance **2** – same value as on Aeros Connection Point Lateral Offset Distance

Figure 30: Front Mount

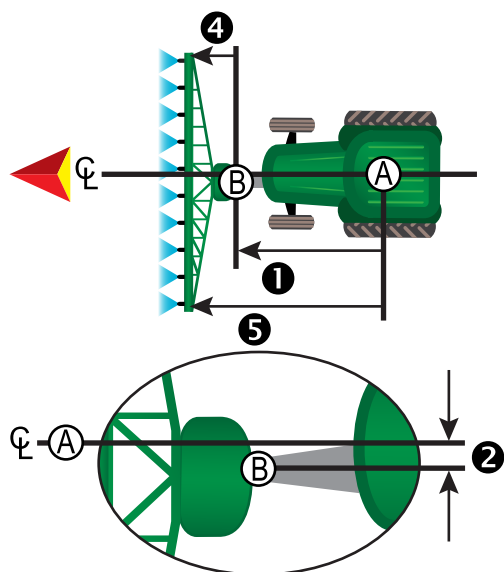
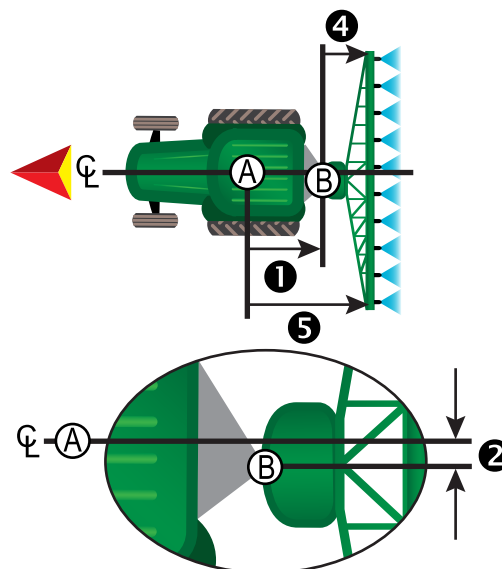



Figure 31: Rear Mount





- (A)** – Center of the GNSS antenna
- (B)** – Connection Point
- 1** – Connection Point In-line Offset Direction/Distance
- 2** – Connection Point Lateral Offset Direction/Distance
- 4** – B=Section X-offset distance
- 5** – Implement In-line Offset Direction/Distance

## Trailed

ISOBUS Sprayer Settings:

1. Press UNIVERSAL TERMINAL bottom tab .
2. From the Main setup screen , select **Machine**.
3. Select **OEM** then enter the access code as needed.
4. Select **Implement Geometry**:
5. Establish values for:
  - ▶ Connector type: **Trailed**
  - ▶ A=Connection X-offset **3** – measured in parallel to the centerline of the machine, define the distance from point **(B)** to the center of the front axle of trailed implement **(C)**
  - ▶ B=Section X-offset **4** – measured in parallel to the centerline of the machine, define the distance from the center of the front axle of trailed implement **(C)** to the implement

Aeros Settings:

1. Press SYSTEM SETUP bottom tab .
2. Press CONFIGURATION side tab .
3. Press **Implement**.
4. Select Implement type **Straight**.
5. Press Implement type NEXT PAGE arrow  to set up specific implement options.
6. Establish values for:

## DATA MANAGEMENT

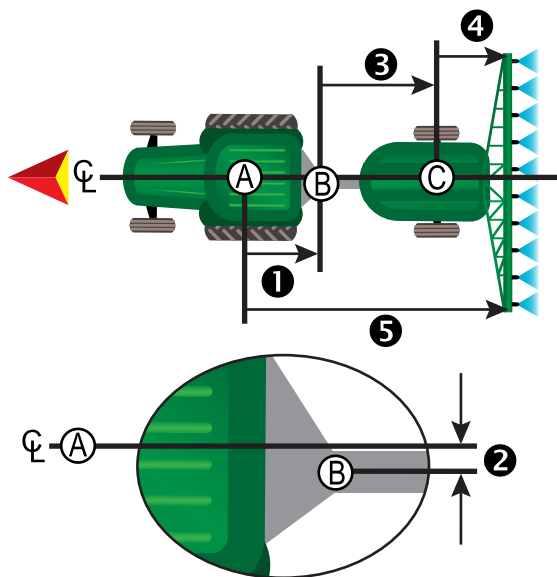

- ▶ Connection Point In-line Offset Direction **1** – define the direction as **Backward** based on ISOBUS Sprayer connection type
- ▶ Connection Point In-line Offset Distance **1** – measured in parallel to the centerline of the machine, define the distance from the GNSS antenna **(A)** to point **(B)**
- ▶ Connection Point Lateral Offset Direction **2** – define the direction, either left or right, from the centerline of the machine to point **(B)** while facing in the machine's forward direction
- ▶ Connection Point Lateral Offset Distance **2** – define the distance from the centerline of the machine to point **(B)**
- ▶ Implement In-line Offset Direction **1** – same direction as Aeros Connection Point In-line Offset Direction
- ▶ Implement In-line Offset Distance **5** – calculated based on Aeros Connection Point In-line Offset Distance **1**, ISOBUS Sprayer A=Connection X-offset **3** and ISOBUS Sprayer B=Section X-offset **4** entries
  - ▶ **1 + 3 + 4 = 5**
- ▶ Implement Lateral Offset Direction **2** – same direction as Aeros Connection Point Lateral Offset Direction
- ▶ Implement Lateral Offset Distance **2** – same value as on Aeros Connection Point Lateral Offset Distance

Figure 32: Always Rear Mount



- (A)** – Center of the GNSS antenna
- (B)** – Connection Point
- (C)** – Center of the front axle of the trailed implement
- 1** – Connection Point In-line Offset Direction/Distance
- 2** – Connection Point Lateral Offset Direction/Distance
- 3** – A=Connection X-offset distance
- 4** – B=Section X-offset distance
- 5** – Implement In-line Offset Direction/Distance

Data Management allows for transfer and management of job data, reporting of job data, changing of job mode, and transfer and management of machine settings.

1. Press SYSTEM SETUP bottom tab .
2. Press DATA MANAGEMENT side tab .
3. Select from:
  - ▶ Job Data – in advanced job mode, used to transfer job information (delete, import, export) and manage job information (create a new job, delete a job, or copy a job's guidelines, boundaries, applied data, prescription map and/or polygons to a new job)
  - ▶ Reports – used to create job reports and save them to a USB drive
  - ▶ Options – used to select simple job mode or advanced job mode
  - ▶ Machine Settings – used to transfer machine settings (delete, import, export) and manage machine setting (create a new machine setting, copy a machine setting, delete a machine setting, save the current machine setting to the selected file, or load the selected file's machine setting)

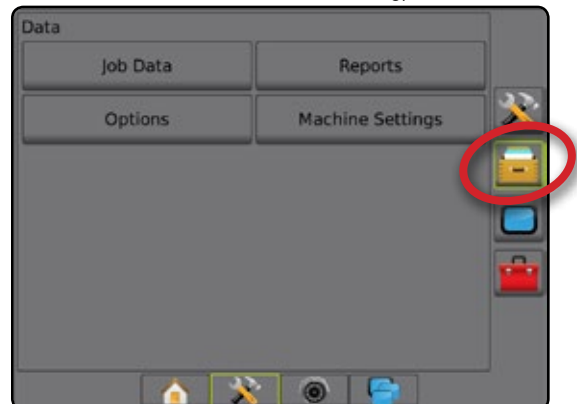





## Job Data

When in advanced job mode, job data options are used to transfer job information (delete, import, export) and manage job information (create a new job, delete a job, or copy a job's guidelines, boundaries, applied data, prescription map and/or polygons to a new job).

Job Data includes:

- Job name
- Client, Farm, and Field names
- Boundary (exterior, interior)
- Polygons
- Coverage Area
- Guidelines
- Maps (Coverage, Prescription, Application, Preset Target Rate)
- Tip Faults

1. Press DATA MANAGEMENT side tab .
2. Press **Job Data**.
3. Select from:
  - ▶ Transfer – when in advanced job mode, allows the transfer of selected jobs to or from a USB drive , as well as deleting jobs . Jobs transferred to a USB storage device can be opened and updated using Fieldware Link. In Fieldware Link a user can input client, farm and field data as well as copy/edit jobs for reuse of boundaries and guidelines. From Fieldware Link, jobs can be ported back to a USB storage device to be moved back onto the console internal storage for use.
  - ▶ Manage – when in advanced job mode, allows the creation of a new empty job, copying of a selected job's Guidelines, Boundaries, Applied Data, and/or Prescription Map to a new job, as well as deleting a selected job
4. Press RETURN arrow  or DATA MANAGEMENT side tab  to return to the main Data Management screen.

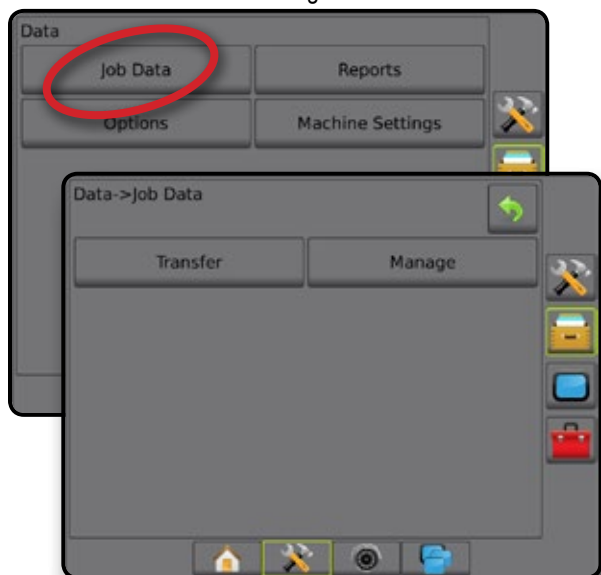

## Copy Job Data

When in advanced job mode, the copy job data option is used to duplicate job information (guidelines, boundaries, applied data, prescription map and/or polygons) to a new job.





1. Press DATA MANAGEMENT side tab .
2. Press **Job Data**.
3. Press **Manage**.
4. Select the job data from which job information is to be duplicated.
5. Press **Copy**.
6. Select the job's guidelines, boundaries, applied data, prescription map and/or polygons to be copied into a new job.
7. Press **Copy**.
8. Name the new job.
9. Press the ACCEPT icon  to save the new job or the CANCEL icon  to leave the keyboard without saving.
10. Press RETURN arrow  or DATA MANAGEMENT side tab  to return to the main Data management screen

Figure 33: Job Data – Copy Data





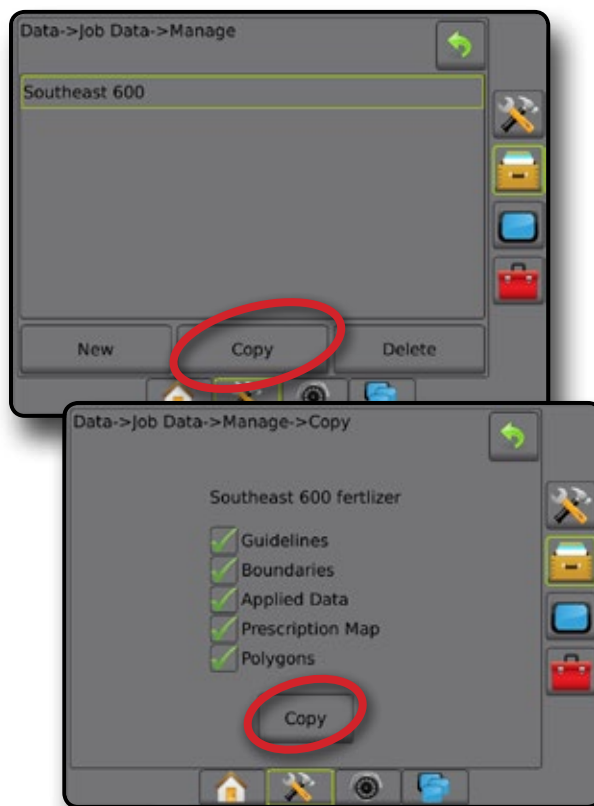

## Machine Settings

The Machine Settings menu is used to create and manage individual Machine Profiles representing the configuration of the console on a particular vehicle/equipment setup. Each Machine Profile records the settings in use at the time the profile is generated allowing the customer to recall their exact setup for later use. Machine Profiles can be used to transfer settings to another console of the same make and model with the same attached hardware.

Machine Settings include:

- Implement settings
- AutoSteer/Tilt Correction settings
- Rate Control settings
- Job-specific settings (including application rates, application type, and Product Channel assignments)

*NOTE: Not all settings are saved as part of the machine settings. See the appendix "Aeros Console Menu Settings" for details.*

1. Press DATA MANAGEMENT side tab .
2. Press **Machine Settings**.
3. Select from:
  - ▶ Transfer – allows the transfer of selected machine settings to or from a USB drive , as well as deleting machine settings . Machine settings transferred to a USB storage device can be opened and updated using Fieldware Link. From Fieldware Link, machine settings can be ported back to a USB storage device to be moved back onto the console internal storage for use.
  - ▶ Manage – allows the creation of a new empty machine settings, the copying of a selected machine settings to a new machine settings, the deletion of a selected machine settings, the saving of the current machine settings to the selected machine settings, or the loading of the selected machine settings to the current settings
4. Press RETURN arrow  or DATA MANAGEMENT side tab  to return to the main Data Management screen.

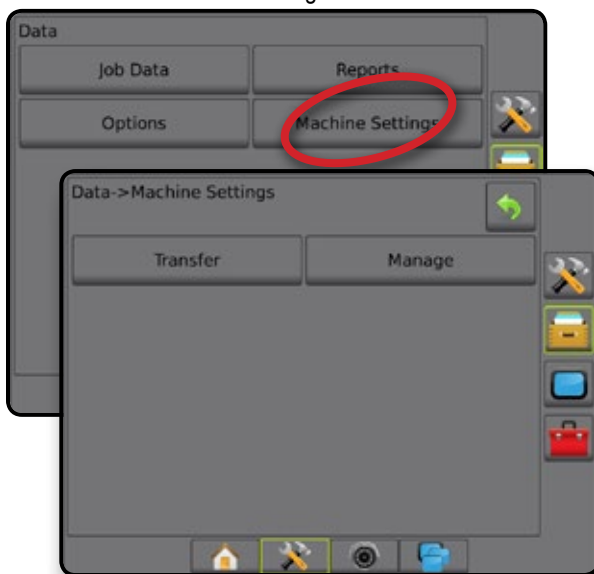

## Copy Machine Profile

The copy machine profile option is used to duplicate the selected machine profile for recall of that profile at a later use. Machine profiles can be used to transfer settings to another console of the same make and model with the same attached hardware.





1. Press DATA MANAGEMENT side tab .
2. Press **Machine settings**.
3. Press **Manage**.
4. Select the machine profile to be copied into a new profile.
5. Press **Copy**.
6. Name the new profile.
7. Press the ACCEPT icon  to save the new profile or the CANCEL icon  to leave the keyboard without saving.
8. Press RETURN arrow  or DATA MANAGEMENT side tab  to return to the main Data management screen

Figure 34: Machine Settings – Copy Profile



# Aeros 9040 Field Computer

## SYSTEM CONFIGURATIONS

The following diagrams are reflective of typical Aeros configurations. Due to the variety of possible configurations, this should be used for reference purposes only.

Figure 35: Aeros IC18 Spreader

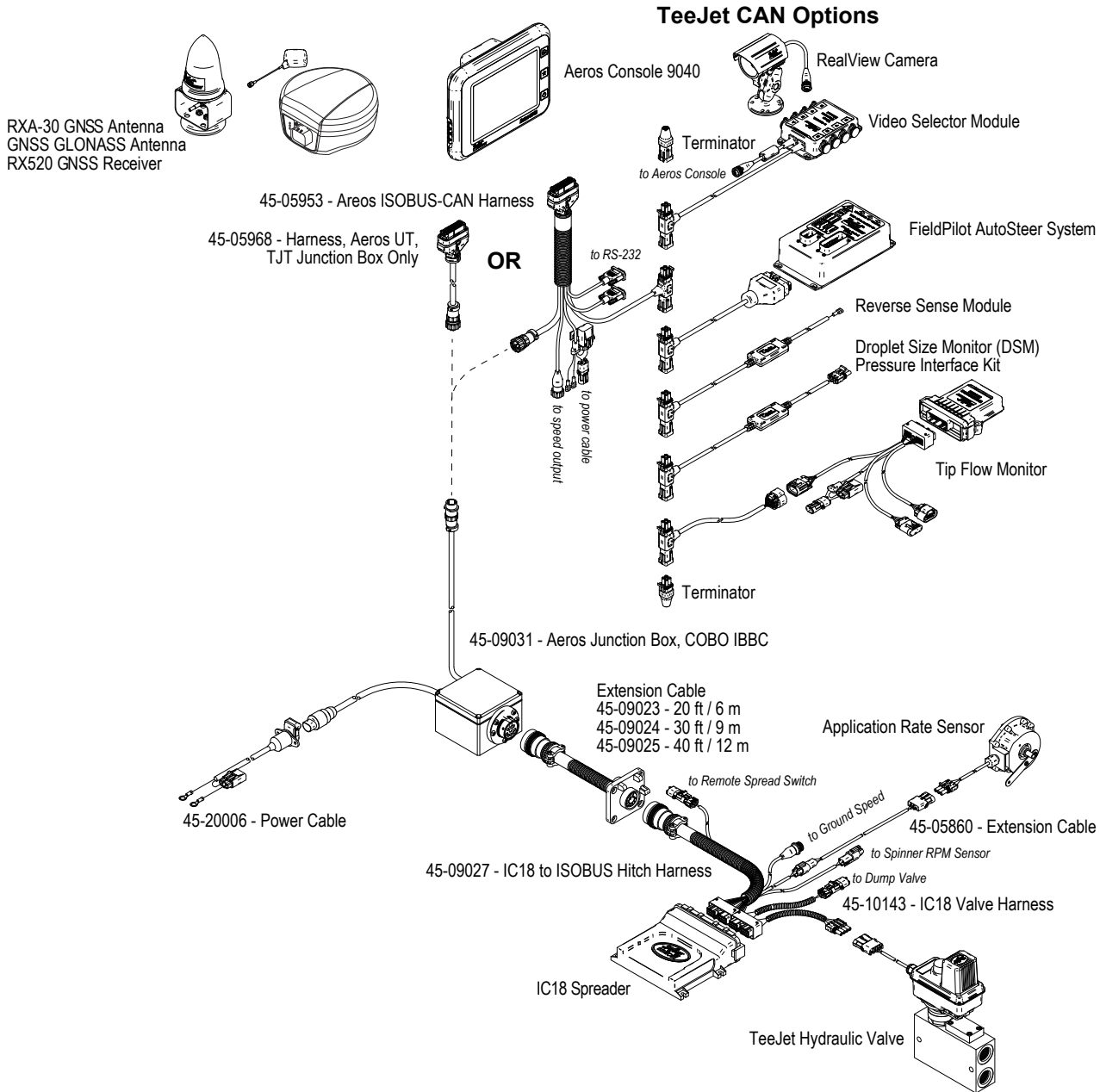
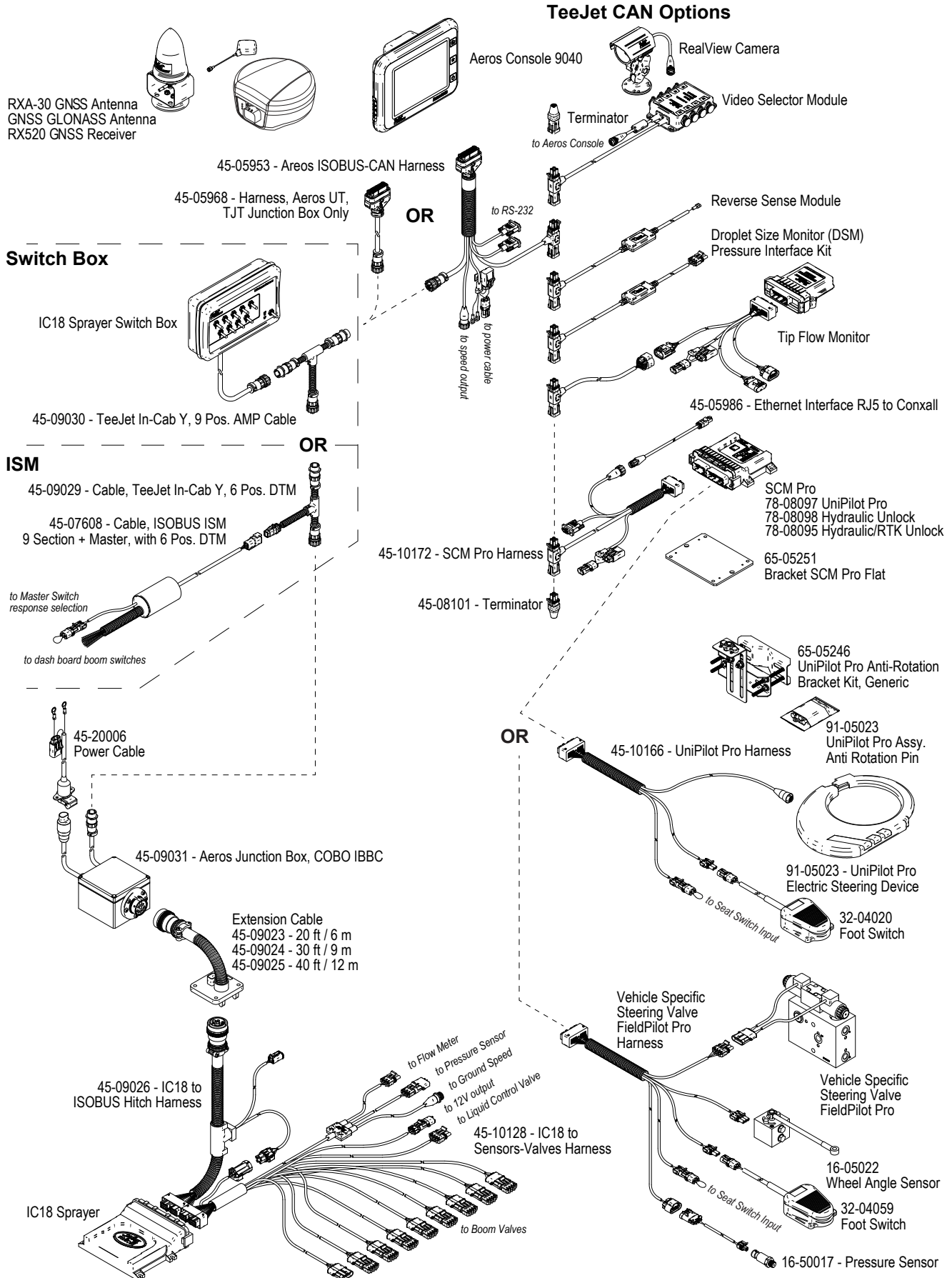



Figure 36: Aeros IC18 Sprayer with FieldPilot Pro or UniPilot Pro Steering System



# AEROS<sup>®</sup> 9040

## USER GUIDE

### START SIMPLE GUIDANCE

#### #1 POWER ON

#### #2 HOME SCREEN

#### #3 GO TO CONFIGURATION

- 1) Set Up the Local Cultural Settings
- 2) Set Up the GNSS
- 3) Set Up the Implement

#### #4 START NEW JOB OR CONTINUE JOB

#### #5 SET UP GUIDANCE

- 1) Choose a Guidance Mode
- 2) Establish an AB guideline
- 3) Create an Application Boundary
- 4) Set Up the Mapping Location

### ADD RATE CONTROL

#### ISOBUS UNIVERSAL TERMINAL



[www.teejet.com](http://www.teejet.com)

A Subsidiary of  Spraying Systems Co.<sup>®</sup>

98-01504-ENUS R3 English-US  
© TeeJet Technologies 2017

#### Copyrights

© 2017 TeeJet Technologies. All rights reserved. No part of this document or the computer programs described in it may be reproduced, copied, photocopied, translated, or reduced in any form or by any means, electronic or machine readable, recording or otherwise, without prior written consent from TeeJet Technologies.

#### Trademarks

Unless otherwise noted, all other brand or product names are trademarks or registered trademarks of their respective companies or organizations.

#### Limitation of Liability

TEEJET TECHNOLOGIES PROVIDES THIS MATERIAL "AS IS" WITHOUT WARRANTY OF ANY KIND, EITHER EXPRESSED OR IMPLIED. NO COPYRIGHT LIABILITY OR PATENT IS ASSUMED. IN NO EVENT SHALL TEEJET TECHNOLOGIES BE LIABLE FOR ANY LOSS OF BUSINESS, LOSS OF PROFIT, LOSS OF USE OR DATA, INTERRUPTION OF BUSINESS, OR FOR INDIRECT, SPECIAL, INCIDENTAL, OR CONSEQUENTIAL DAMAGES OF ANY KIND, EVEN IF TEEJET TECHNOLOGIES HAS BEEN ADVISED OF SUCH DAMAGES ARISING FROM TEEJET TECHNOLOGIES SOFTWARE.