

Fieldware for The Legacy 6000
Software Version 2.11

LEGACY 6000 CAN BUS

USER GUIDE

Software Version 2.11
98-05053 R1

Midwest Technologies
2864 Old Rochester Road
Springfield, IL 62703
217.753.8424

www.mid-tech.com www.teejet.com

Fieldware for The Legacy 6000

Software Version 2.11

Copyrights

© 1999 Midwest Technologies Inc. All rights reserved. No part of this document or the computer programs described in it may be reproduced, copied, photocopied, translated or reduced in any form or by any means, electronic or machine readable, recording or otherwise, without prior written consent from Midwest Technologies, Inc.

Trademarks

Unless otherwise noted, all other brand or product names are trademarks or registered trademarks of their respective companies or organizations.

Limitation of Liability

MIDWEST TECHNOLOGIES, INC. PROVIDES THIS MATERIAL "AS IS" WITHOUT WARRANTY OF ANY KIND, EITHER EXPRESSED OR IMPLIED. NO COPYRIGHT LIABILITY OR PATENT IS ASSUMED. IN NO EVENT SHALL MIDWEST TECHNOLOGIES, INC BE LIABLE FOR ANY LOSS OF BUSINESS, LOSS OF PROFIT, LOSS OF USE OR DATA, INTERRUPTION OF BUSINESS, OR FOR INDIRECT, SPECIAL, INCIDENTAL, OR CONSEQUENTIAL DAMAGES OF ANY KIND, EVEN IF MID-TECH HAS BEEN ADVISED OF SUCH DAMAGES ARISING FROM MID-TECH SOFTWARE.

Table of Contents

Chapter 1 - System Introduction 1

System Introduction	1-2
System Features	1-2
CAN Bus Versatility and Value	1-3
What is a CAN Bus and why use one?	1-3
Fieldware for the Legacy 6000	1-4
Mid-Tech CAN Bus System Overview	1-5
The Legacy 6000 Console	1-5
Power Speed Module	1-6
Inputs	1-6
Inputs/Outputs	1-6
Switch Sense Module	1-7
Inputs	1-7
Communication	1-7
Switch Function Module	1-8
Outputs	1-8
Input	1-8
Communication	1-8
Product Control Module	1-9
Inputs	1-9
Outputs	1-9
Communication	1-9
Swath XL Lightbar	1-10
Communication:	1-10
CAN Bus Cable Specifications	1-11
CAN Modules (PCM, SSM, PSM)	1-11
Cable Harnesses	1-12
Power Speed Module (PSM)	1-12
Switch Sense Module	1-12
Product Control Module	1-13
Typical Legacy 6000 Configurations	1-14
Single Channel Liquid Flow Meter	1-14
Single Channel Granular Spreader	1-15
Single Channel Liquid with AutoBoom Shutoff (SFM)	1-16
Dual Channel with Wet and Dry Booms	1-17
Dual Channel Granular with Two Sensors per Channel	1-18
Chapter Notes	1-19

Chapter 2 - Getting Started 1

Software Overview	2-2
Powering Up	2-2
Screen Navigation & Selection	2-3
Standard Pages	2-4
Launcher Page	2-4
Setup Menu Page	2-5
Setup Wizard	2-5
Setup Sub-Groups	2-5
Exiting a Setup Menu Page	2-5
Data Entry Page	2-6
Pick List Data Entry	2-6
Alpha/Numeric Data Entry	2-6
System Setup	2-7
Console Setup	2-8
Lightbar Setup	2-9
GPS Receiver Setup	2-10
Implement Setup	2-11
The Vehicle Coordinate System	2-11
The X and Y Axes	2-11
Location of GPS Antenna	2-11
Swaths and Sections	2-11
Entering the Implement Width	2-13
Number of Swaths Page	2-14
Entering the Number of Sections in a Swath	2-14
Setting the Section to Switch Assignment	2-15
Entering the Section Width	2-15
Entering the Offset Direction Y	2-16
The Offset Distance Y	2-16
Entering the Offset Direction X	2-17
Setting the PCM Assignment	2-18
Completing Implement Setup	2-19
Product Control Module (PCM) Setup	2-20
Selecting a PCM Setup Favorite	2-22
Setting the Application Type	2-24
Application Type Options	2-24
Application Type Settings	2-25
Setting the Drive Type	2-26
Drive Type Settings	2-27
Calculating the Prime Value	2-27
Setting the Units	2-29
Selecting the Primary Sensor	2-30

Fieldware for The Legacy 6000

Software Version 2.11

Primary Sensor Settings	2-31
Selecting the Secondary Sensor	2-33
Secondary Sensor Settings	2-34
Selecting a Monitor	2-36
Monitor Settings	2-37
Finishing the PCM Setup	2-39
Saving the PCM Setup to a File	2-40
Chapter Notes	2-41
Chapter 3 - Real-time Setup 1	
Operation Overview	3-2
Starting a Job	3-4
Creating a New Job	3-4
Selecting an Existing Job	3-4
Creating a Job Based on an Existing Job	3-4
Manually Naming a Job	3-5
Automatically Naming a Job	3-5
No PCMCIA Card Setup	3-6
ARM Launcher	3-7
No PCMCIA Card Setup	3-7
Performing a Calibration	3-8
Introduction	3-8
The Common Calibration Procedure	3-8
Distance/Speed Calibration	3-9
Distance/Speed Calibration Continued	3-10
Liquid Flow Static Calibration	3-11
Liquid Flow Static Calibration / Continued	3-12
Liquid Flow In-Field Calibration	3-13
Liquid Flow In-Field Calibration Continued	3-14
Granular & Seeder Static Calibration	3-15
Granular & Seeder Static Calibration / Continued	3-16
Granular & Seeder In-Field Calibration	3-17
Granular & Seeder In-Field Calibration Continued	3-18
Pressure Calibration	3-19
Pressure Calibration / Continued	3-20
NH3 In-Field Calibration	3-21
NH3 In-Field Calibration Continued	3-22
Injection Static Calibration	3-23
Prime Injection System	3-25
1. Calculate Prime value	3-25
2. Setup System for Priming	3-26
3. Start Prime	3-26

Reverse Prime Injection System	3-27
1. Setup Stem for Reverse Priming	3-28
2. Start Reverse Prime	3-28
Job Report Setup	3-29
No PCMCIA Card Selected	3-29
Running the Job Report Wizard	3-29
Job Report Detailed Description	3-30
ARM Setup	3-31
No PCMCIA Card Selected	3-31
Running the ARM setup Wizard	3-31
ARM Setup Detailed Description	3-32
Auto Boom Shutoff (Section Center)	3-33
Enter a Record, Boundary, Guideline, or Map File Name	3-34
Product Setup	3-35
Running the Product Setup Wizard	3-35
Product Setup Detailed Description	3-36
The Select PCM Page	3-37
Select the Product Name	3-38
Selecting a Product from the Products Database	3-38
Favorites	3-38
New Product	3-38
Variable Rate Application	3-39
Selecting Prescription Map	3-39
Single Product Variable Rate Prescription Map	3-39
Multiproduct Variable Rate	3-40
Prescription Map for Each Product	3-40
One Prescription Map for All Products	3-41
Select the Prescription Map Layer	3-42
Chapter Notes	3-43

Chapter 4 - Real-time Operation 1

Product Application	4-2
Real-time pages	4-2
Information Pages	4-3
Rate Pages	4-3
GPS / Boundary Page	4-3
Adjusting the Product Application Rate	4-4
Manual Control	4-4
Test Speed	4-5
Reset Initial Quantity	4-5
Information Page Soft Keys Descriptions	4-6
The Map Page	4-7

Fieldware for The Legacy 6000

Software Version 2.11

Real-time Map Page Soft-key Descriptions	4-8
System, Warning and Error Messages	4-11
System Message	4-11
Warning Message	4-11
Error Message	4-12
Real-time Guidance Operation	4-13
Starting Guidance	4-13
Changing Guidance Pattern	4-13
The Straight-Line Guidance Pattern	4-14
Mark Point A	4-14
Mark Point B	4-14
The Headland Guidance Pattern	4-15
Applying Multiple Headland Circuits	4-15
Headland Pattern Example	4-16
Switching from Headland to Straight-line A-B Pattern	4-17
The Ignore Headland Guidance Pattern	4-19
Ignore Headland Pattern Example	4-20
Step 1: Start Applying Headlands	4-20
Step 2: Select Headland Off Mode	4-20
Step 3: Establish First Interior Pass	4-21
Step 4: Ignore Headland Data	4-21
If you forgot to start a headland, you can:	4-22
The Circle Pivot Pattern	4-23
Circle Pivot Example	4-24
Marking Point A	4-24
Marking Point B	4-24
Driving in the Circle Pivot Pattern	4-25
Lightbar Curved Guidance Graphics	4-27
Applied Area Detection	4-28
Detecting A Previously Applied Area	4-28
Detecting Neighboring Swath	4-28
Mapping a Field Boundary	4-30
Closing or Pausing the Boundary Mapping Process	4-30
Mapping Points and Hazards	4-32
Marking a Point	4-32
Marking a Hazard	4-33
Object Name File	4-33
Exiting Real-Time Operation	4-34
Fieldware-Map Manager	4-34
Lightbar Index	4-35
Data Transfer and Report Generation	4-38

Chapter Notes 4-39

Chapter 5 - System Tools 1

System Tools 5-2

- Device Manager 5-3
 - CAN Bus 5-3
 - GPS Receiver 5-4
 - LightBar 5-4
- Lightbar SoftKeys and Description 5-4
 - PCM, SSM, and PSM 5-5
- PCM, SSM, & PSM SoftKeys and Description 5-5
 - Console 5-6
- Console SoftKeys and Description 5-6
 - Backing up Console System Files 5-7
- Required Items: 5-7
 - Restoring Console System Files 5-7
 - Importing Object Name Files into Console Memory 5-8
- Card Manager 5-9
- Card Manager SoftKeys and Description 5-9

Chapter Notes 5-11

Chapter 6 - Running Mapper 1

Mapper Introduction 6-2

- Starting Mapper 6-2
- Starting a Job 6-3
 - Creating a New Job 6-3
 - Selecting an Existing Job 6-3
 - Creating a Job Based on an Existing Job 6-3
 - Manually Naming a Job 6-4
 - Automatically Naming a Job 6-4
- Mapper Setup 6-5
- Mapper Setup and Operation Steps 6-5
 - Mapper Setup 6-6
 - Road Markers 6-7
- Enter Road Marker Name 6-8
 - Creating Object Name 6-9
 - Creating New Object Name 6-9
- Real-time pages 6-10
 - Map page 6-10
 - Map Page Soft Keys Descriptions 6-11
 - Information Page 6-13
 - Information Page SoftKeys and Description 6-13

Mapper Tools 6-14

Fieldware for The Legacy 6000

Software Version 2.11

The Options Menu	6-16
Exiting Real-Time Operation	6-17
Map Manager	6-17
Chapter Notes	6-18
Appendix A - PCM Favorites Settings	A-1
Appendix B - Creating a Calibration Table	B-1
Creating a Calibration Table on a PC	B-1
Loading Calibration Table in Legacy 6000	B-2
Using the Calibration Table	B-3
Creating a Calibration Table Using the Legacy 6000	B-4
Appendix C - NH3 Application	C-1
NH3 Application Cal#	C-1
Density for NH3 and Actual N	C-1
Example:	C-1
Notes	C-2

Fieldware for The Legacy 6000

Software Version 2.11

Chapter 1 - System Introduction

An introduction to the Legacy 6000 System.

Software Version 2.11

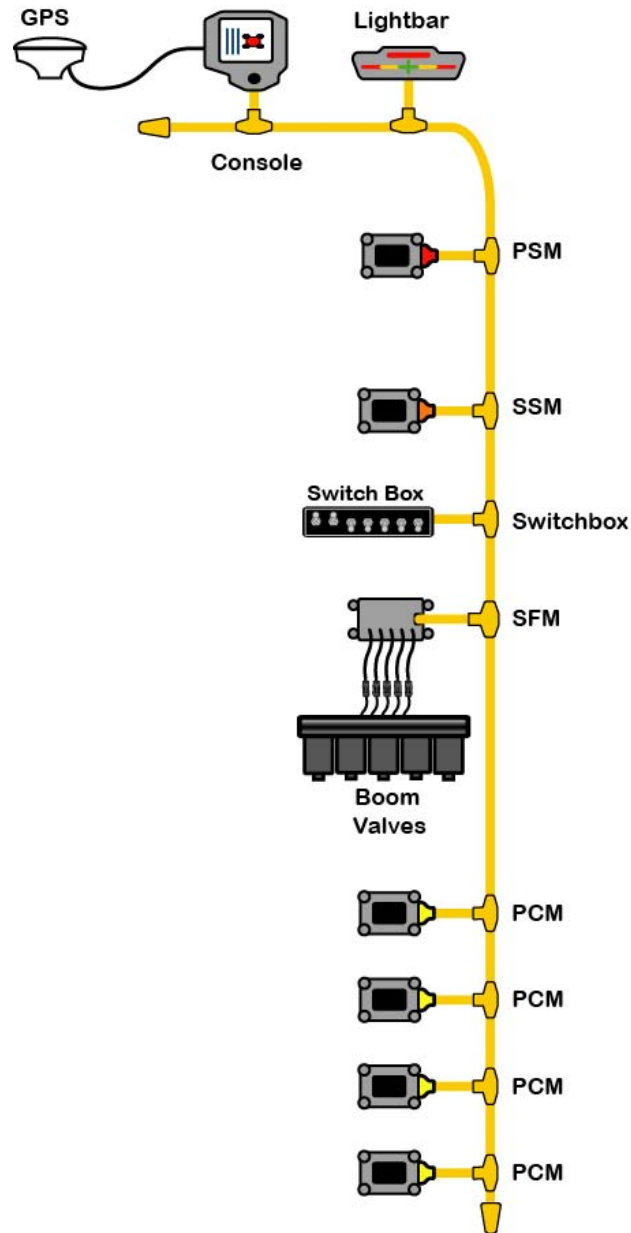

System Introduction

The Legacy 6000 system allows the control of all product types, plus GPS mapping, guidance, and data collection in a single console. Replacing multiple consoles in the cab with one robust system, Mid-Tech's Legacy 6000 sets a new standard for control systems of the future.

The Legacy 6000 runs Fieldware software in a Windows CE environment, an extremely dependable and stable operating system. Operation is intuitive with on-screen menu choices and prompts. An on-board help menu is built in. The heart of the Legacy console is an Intel processor operating at 206 Megahertz for maximum efficiency.

System Features

System features include:

- Product control with optional integrated guidance
- Four guidance modes, Ignore Headland, Curved, Parallel and Center Pivot.
- Single console in the cab with a single cable connection to the console
- Simplifies operation of product control and GPS record keeping
- Works with Mid-Tech's Swath XL lightbar
- Comes fully loaded with "Fieldware for the Legacy 6000" software
- Precise control of liquid & dry products on common delivery systems
- Flow- or pressure-based liquid control with multiple sensor inputs for each product
- Handles up to 20 individual boom sections and 4 swaths
- Up to 5 application rates per product can be preset and accessed on the go
- Supports granular application control using 2 rate sensors per product
- Compatible with most sensors, valves, and D.C. drives
- Operates bi-directional or PWM valves
- Operator selectable gain settings for control valves
- Adding additional product control is easy
- Single high speed bus cable coming into cab
- Automatic Boom shutoff
- Mapper option for mapping points, lines, and polygons

CAN Bus Versatility and Value

The Legacy 6000 utilizes CAN Bus technology, a new industry standard, which Mid-Tech uses to execute precise product control in an environment more robust than any of its predecessors.

What is a CAN Bus and why use one?

Controller Area Network (CAN) is a system comprised of independent, intelligent modules connected by a single high-speed cable, known as a bus, over which all the data in the system travels.

CAN was originally developed for the automotive industry to provide a cost effective means for a large number of electronic functions or systems to be interconnected without large, expensive and troublesome wiring harnesses.

Within a CAN system, each module contains its own microprocessor. All modules share a standard protocol or communication sequence, which conforms to the ISO 11898 standard. Since modules have built-in computing power, a CAN system is extremely flexible and easily expands to meet a customer's needs.

Individual modules have a specific and unique function to execute, as well as the responsibility to constantly report that function and its current status. Data on the CAN is available many times a second allowing the operation of a very fast, responsive control system.

The Legacy 6000 uses 5 types of modules, each having a unique function. Each described in more detail below. The console in the cab is one of these modules and serves as the user interface. The remaining modules are positioned around the chassis close to the area they influence. For instance, the Product Control Module (PCM) connects to the actuator and sensor and controls the actual release of the product. To upgrade from one-product to three-product application (or more) is simply a matter of adding additional PCM's to the system.

Fieldware for The Legacy 6000

Software Version 2.11

Fieldware for the Legacy 6000

Plug any standard submeter GPS receiver and Mid-Tech's CAN based Swath XL lightbar into the Legacy 6000 system, and enjoy straight-line, curved or center pivot guidance at your command. Application maps can be viewed on the Legacy 6000 display as you apply. Cross track error, area applied, application rates, and other vital information display on the Swath XL lightbar in real time.

Features of Mid-Tech's Fieldware software, developed specifically for the Legacy 6000, include:

- Application Rate Management - permits precise fixed or variable rate application.
- Extensive Product Control Module setup.
- Full system calibration including, granular, liquid, liquid injection and distance.
- CAN Bus, GPS receiver and lightbar diagnostics.
- Create application jobs keeping track of customer, weather and product information.
- Large product database with over 4000 entries containing product name, formulation, and EPA number.
- Integrated guidance using straight line, headland, or center pivot modes, plus text reporting to the lightbar, in one easy to use format.
- Report generation - full application reports and maps can be generated in Fieldware Map Manager PC software at the end of the day. An application report contains a map of the application, customer information, product information, as well as weather, field, and soil conditions.

Mid-Tech CAN Bus System Overview

The Mid-Tech CAN bus system is comprised of several components (modules). The Console, the Power Speed Module (PSM), the Switch Sense Module (SSM), a Product Control Module (PCM), and a Lightbar. At a minimum, four of these modules are required to have a fully functional Legacy 6000 single product control system. The lightbar is optional. To control more than one product, you will need to add an additional PCM for each additional product you choose to control.

The Legacy 6000 Console

Dimensions: 8.0" Wide x 7.7" High x 4.5" Deep (203 x 196 x 114 mm)

Weight: 2.3 lbs. (1.0 kg)

Enclosure: High impact plastic; back lighted, tactile feed-back switches on front panel

Operator Interface: Back lighted, tactile feed-back switches on front panel

Display: 5.7" diagonal (120 x 90 mm), transfective, QVGA with CCFL back lighting. Brightness and contrast controlled by switches on the front panel of the console.

Communication: CAN, 29 bit ID, 250K baud, Mid-Tech proprietary messages, Serial RS 232 (2), USB: (1)

Memory: 64 Mbytes DRAM, 32 Mbytes Flash

Microprocessor: 32-bit Intel StrongARM, SA 1110 with SA 1111 companion chip. 206 MHz.

Drives: PCMCIA type II, single slot

Operating System: Microsoft Windows CE 3.0

Power Requirement: 9 to 16 volts DC

Connector: Sealed, 31 pin Deutsch

GPS Receiver Compatibility: Compatible with any differentially corrected submeter GPS (DGPS) receiver which outputs NMEA 0183 at 2 to 10 Hz.

Alarm: Audible alarm

Other:

* Real-time clock with battery back-up

* Simple, yet versatile, RAM mounting system.

Power Speed Module

The Power Speed Module (PSM) is the primary arbitrator of the Bus. This module includes the input point for the speed sensor, the input for power for the CAN bus, a gateway to communicate with a parallel CAN bus and provides a fully functional RS-232 port as alternative I/O.



Figure 1-1: Power Speed Module

Inputs

Speed 1: digital, 0-12 VDC, optimized for 50% duty cycle, 0-5 KHz, primary input

Speed 2: digital, 0-12 VDC, optimized for 50% duty cycle, 0-5 KHz, secondary input

Ignition sense: digital, 0-16 VDC, (Hi state is ON)

Battery Power: 0-16 VDC

Inputs/Outputs

Mid-Tech CAN: ISO 11898 (Bosch 2.0B), 29 bit ID, 250K baud, Mid-Tech proprietary messages

Gateway CAN: ISO 11898 (Bosch 2.0B), 29 bit ID, 250K baud, Mid-Tech proprietary messages

Serial RS 232: TXD, RXD, RTS, CTS and ground.

Switch Sense Module

The Switch Sense Module (SSM) senses the status of switches aboard the machine and transforms the switch state into messages meaningful to the CAN Bus.



Figure 1-2: Switch Sense Module (SSM)

Inputs

Booms inputs: up to 20, digital, 0-12 VDC, HI/LO sensing

Ground Speed Override (GSO): 1 input, digital, 0-12 VDC, HI/LO sensing

Machine status: 1 input, digital, 0-12 VDC, HI/LO sensing

Communication

Mid-Tech CAN: 29 bit ID, 250K baud, Mid-Tech proprietary messages

Switch Function Module

The Switch Function Module (SFM) enables automated system control of boom sections.



Figure 1-3: Switch Function Module (SFM)

Outputs

Booms outputs: (10) 3amp +12switched

Output Connector: A - Ground, B - N/C, C - +12 Open, D - +12 Constant

Input

Battery Power: 30amp

Communication

Mid-Tech CAN: ISO 11898 (Bosch 2.0B), 29 bit ID, 250K baud, Mid-Tech proprietary messages

Product Control Module

The Product Control Module (PCM) performs the actual control function for the Mid-Tech CAN Bus and connects the actuator and sensor. Control outputs can be bi-directional. One PCM is required for each product you wish to control.



Figure 1-4: Product Control Module

Inputs

Digital sensor: 4 inputs, digital, 0-12 VDC, 0-5 KHz

Analog sensor: 2 inputs, analog, 0-5 VDC. One of these inputs can be converted to a 4-20 ma sensor input by software command.

Battery: 1 Battery Power for the actuator outputs, 12-24 VDC, 10 amp

Outputs

Actuator: 2 outputs, 0-12 VDC, 5 amp each

Regulated: 1 output, 11 VDC, 3 amp

Switched: 1 output, 12 VDC, 5 amp

Sensor power: 3 outputs, 12 VDC, 300 mA total

Communication

Mid-Tech CAN: ISO 11898 (Bosch 2.0B), 29 bit ID, 250K baud, Mid-Tech proprietary messages

Serial: Asynchronous RXD and TXD only

Swath XL Lightbar

A CAN based Swath XL Lightbar was developed specifically for the Legacy 6000 system. The Lightbar is required for applications using guidance and recommended for non-guidance uses as well. In non-guidance use (logging data only) the lightbar can provide area and rate feed back.



Figure 1-5: Swath XL Lightbar

Dimensions: 16.0" Wide x 3.0" High x 3.0" Deep (405 x 76 x 76 mm)

Weight: 8 oz. (0.22 kg)

Enclosure: ABS / Poly carbonate alloy construction. Can be mounted to the exterior of the vehicle.

Cable: Mid-Tech proprietary CAN Bus cable. Cable extension available.

Front Panel LEDs: High-lumen red, yellow and green, adjustable brightness.

Text Display: 8-character, high intensity LED alphanumeric text display, brightness adjustment.

Mounting Bracket: Can be mounted on dash, from ceiling, interior or exterior with large easy to grip knobs.

Communication:

Mid-Tech CAN: ISO 11898 (Bosch 2.0B), 29 bit ID, 250K baud, Mid-Tech proprietary messages

CAN Bus Cable Specifications

5-wire cable with molded connectors. Male or female terminator required on each end.

Pin 1: Ground

Pin 2: +12V

Pin 3: Reserved

Pin 4: CAN High

Pin 5: CAN Low

Speed: 250k baud message update

Module Processor: Siemens C167

Module CAN interface: Siemens 82C250

Message Protocol: ISO 11898 (Bosch 2.0B), 29 bit ID, 250K baud, Mid-Tech proprietary messages

CAN Modules (PCM, SSM, PSM)

Dimensions: 4.7" W x 2.3" H x 6.0" D (120 x 60 x 150 mm)

Weight: 1.9 lbs. (0.9 kg)

Materials: Powder coated cast aluminum



Figure 1-6: CAN Modules

Cable Harnesses

Power Speed Module (PSM)

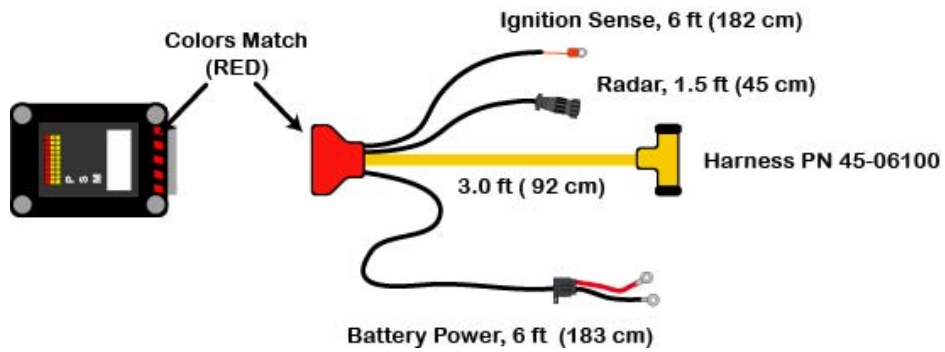

Figure 1-7: Power Speed Module Harness

Switch Sense Module

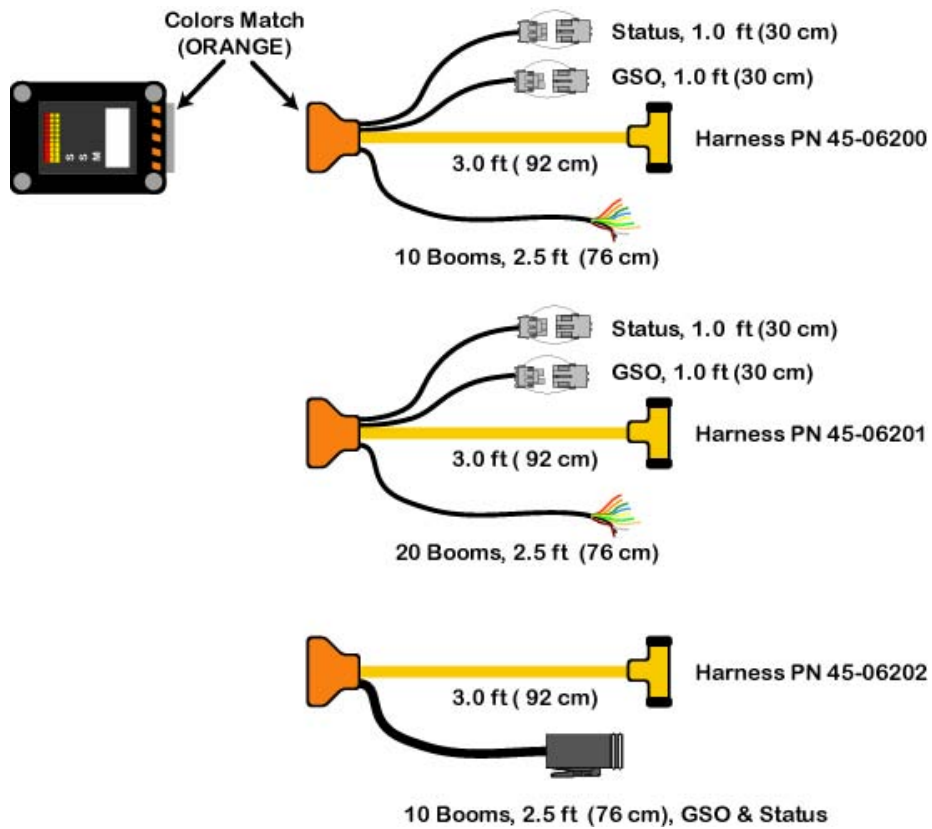

Figure 1-8: Switch Sense Module Harness Options

Product Control Module

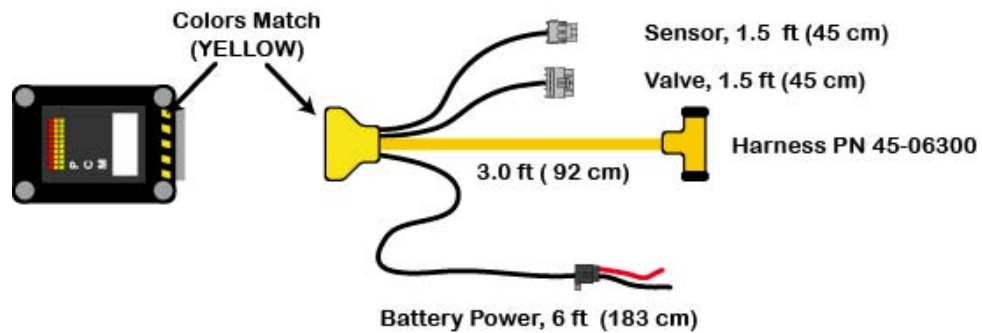

Figure 1-9: Power Control Module Harness

PCM Cable Options											
	Sensor Inputs										
Part Number	A	B	C	D	E	F	CAN	PWR	Valve	Sen.	Description
45-06300	X						X	X	X	1	Single Sensor
45-06301	X			X			X	X	X	2	Single Sensor w/rpm
45-06302	X	X		X			X	X	X	3	Dual Sensor w/rpm
45-06303	X					X	X	X	X	2	Single Sensor w/press
45-06304					X		X	X	X	1	Pressure Control Single
45-06305					X	X	X	X	X	2	Pressure Control, Dual

Table 1-1: PCM Cable Options

NOTE: These cable configurations are available as of 1/1/03. Contact Mid-Tech Customer Service for other specific sensor or I/O options.

Typical Legacy 6000 Configurations

The following schematics reflect some typical Legacy 6000 configurations. Due to the variety of possible configurations, these schematics should be used for general reference. Contact Midwest Technologies or your dealer for detailed information regarding your specific configuration and installation.

Single Channel Liquid Flow Meter

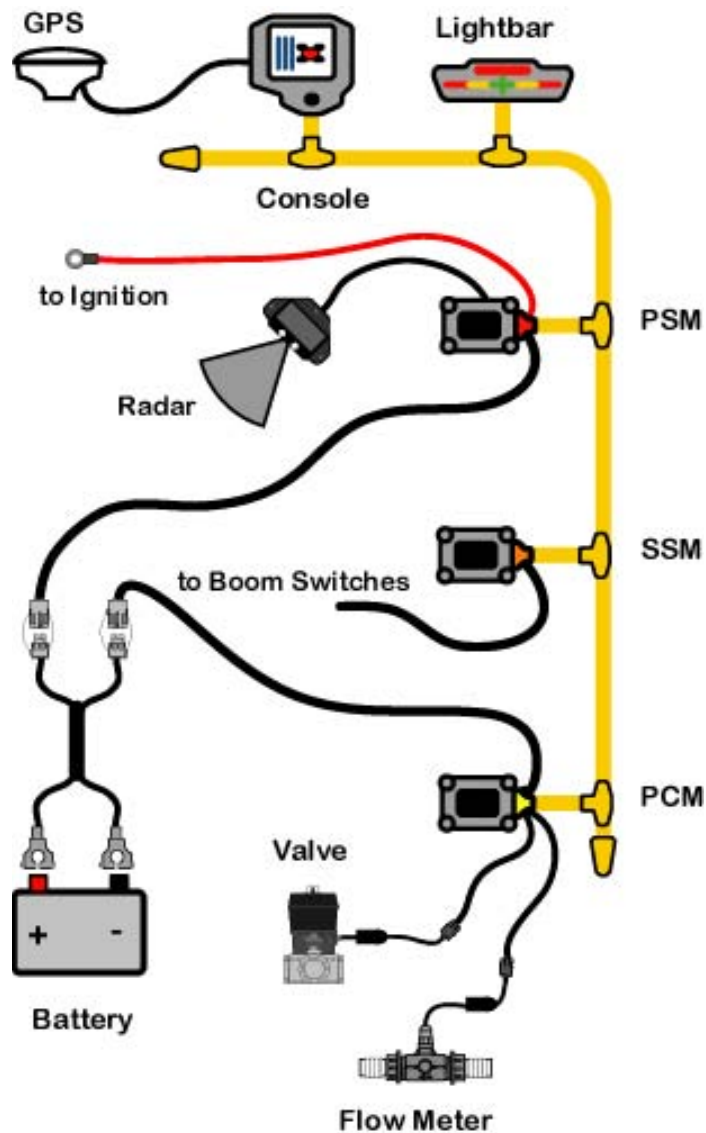

Figure 1-10: Single Channel Liquid Flow Meter Configuration

Single Channel Granular Spreader

This is a typical single product granular configuration with spreader control.

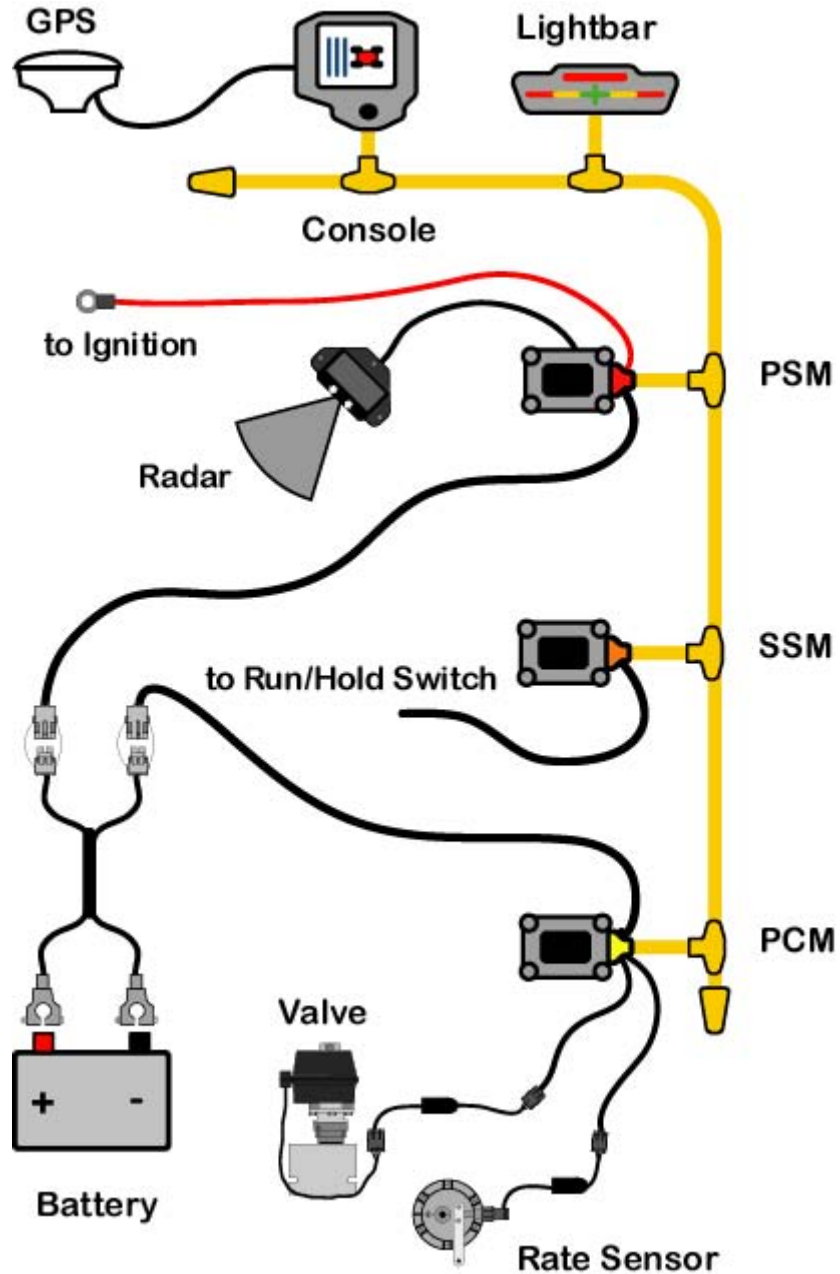

Figure 1-11: Single Channel Granular Spreader Configuration

Single Channel Liquid with AutoBoom Shutoff (SFM)

This configuration show the Autoboom Shutoff feature using the Switch Function Module (SFM)

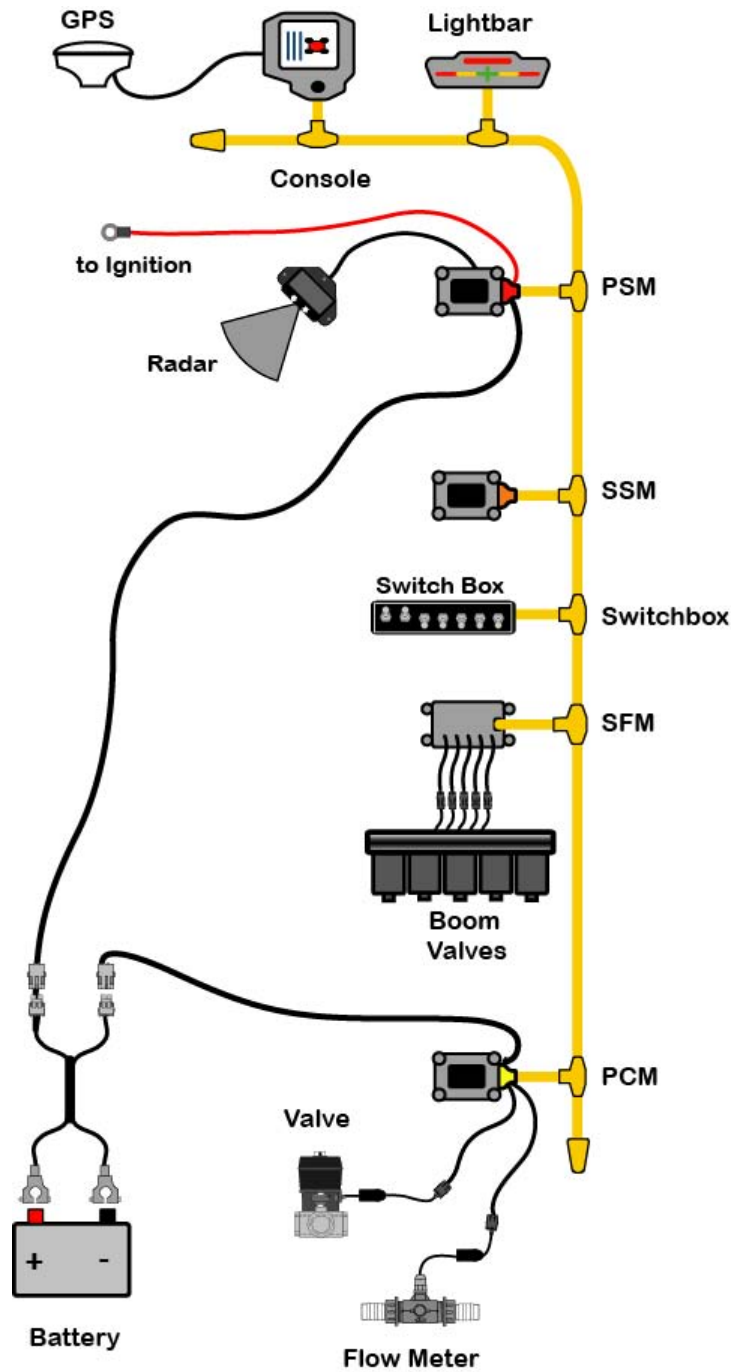

Figure 1-12: Single Channel Liquid with AutoBoom Shutoff

Dual Channel with Wet and Dry Booms

This is a typical two product configuration, one liquid and one dry, for a vehicle with wet and dry booms.

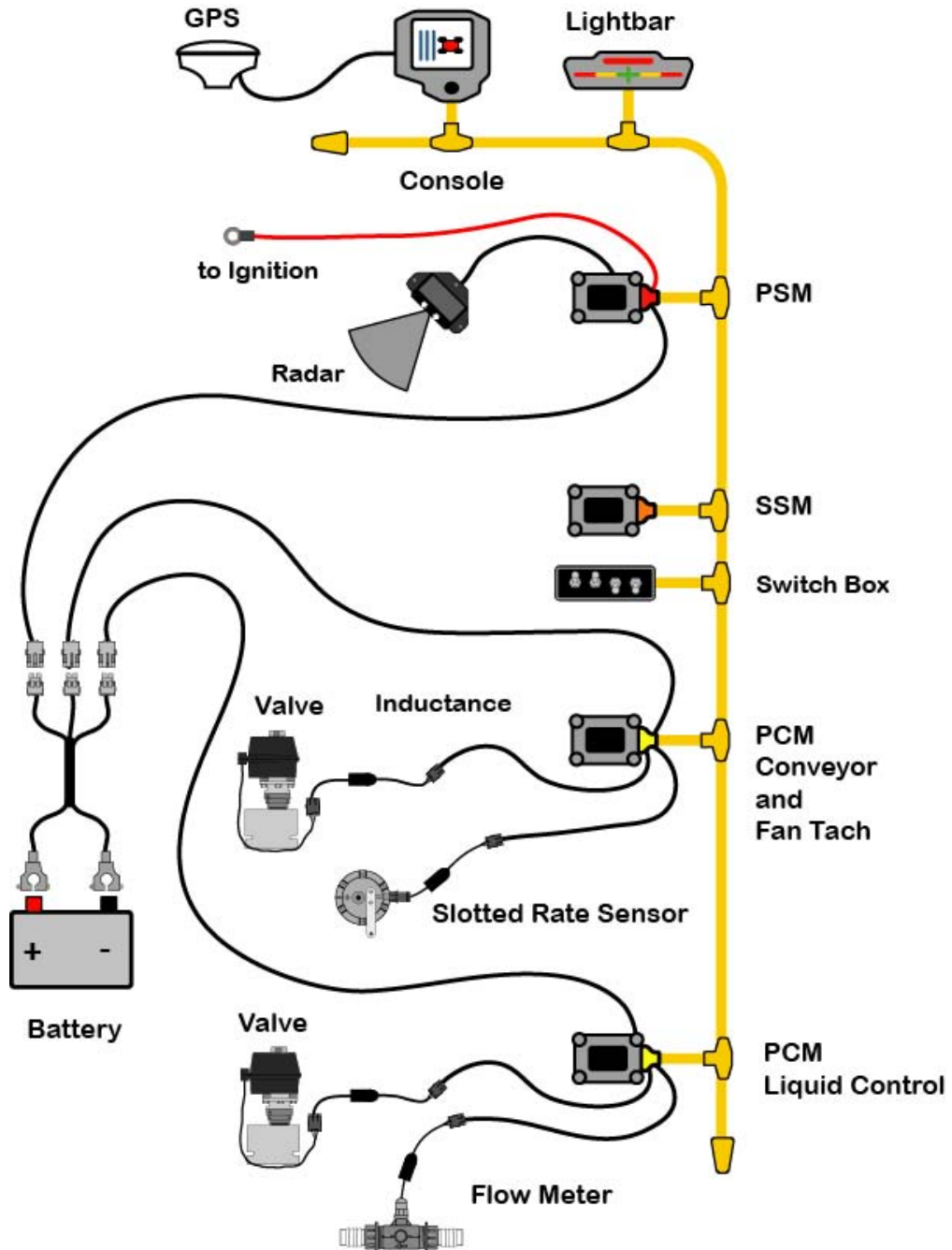

Figure 1-13: Dual Channel Wet/Dry Configuration

Dual Channel Granular with Two Sensors per Channel

This is a typical two product granular layout with two slotted rate sensors per channel.

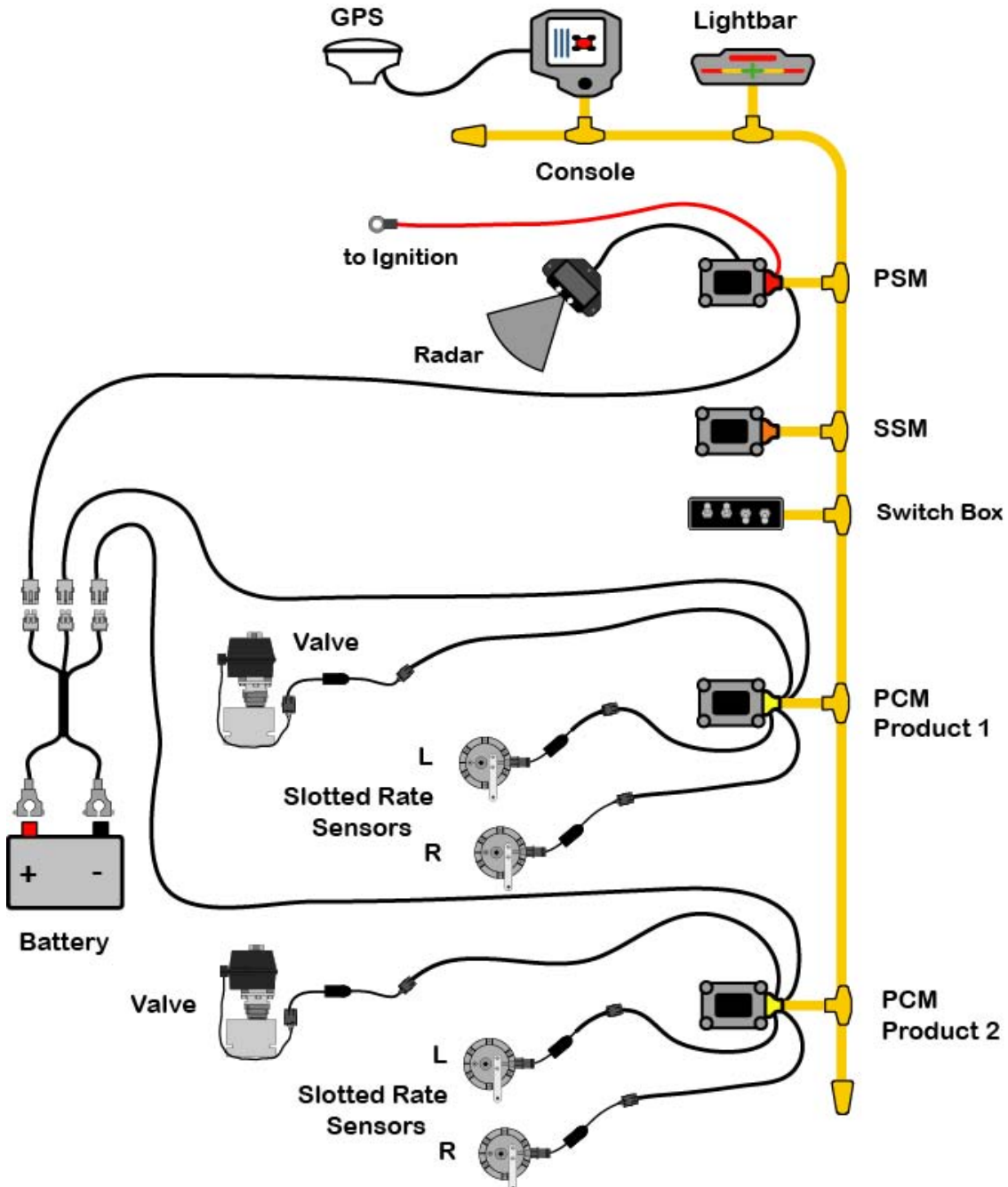

Figure 1-14: Dual Channel Granular with Two Sensors per Channel

Chapter Notes

Chapter 2 - Getting Started

Setting up "Fieldware for the Legacy 6000".

Software Version 2.11

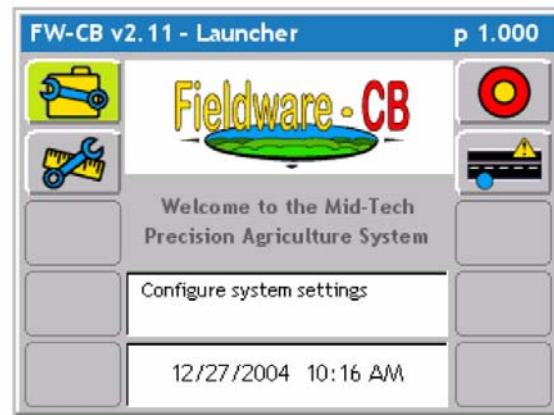

Software Overview

This section assumes that the Legacy 6000 hardware has been properly installed and clean reliable power has been supplied. For a list of typical hardware configurations (See "Typical Legacy 6000 Configurations" on page 1-14.).



Figure 2-1: The Legacy 6000 Console

Powering Up

To power up the Legacy 6000 console, press the orange button to the left side of the console faceplate (Figure 2-1). When the Legacy 6000 console has been powered up, "Fieldware for the Legacy 6000" will automatically start up. The first software page you will see is the Main Fieldware Launcher (Figure 2-2). System Setup, System Tools, Application Rate Manager (ARM) and Mapper are easily accessible from the Main Launcher Page. This Chapter focuses on how "Fieldware for the Legacy 6000" operates and how to configure your system using the System Setup application.

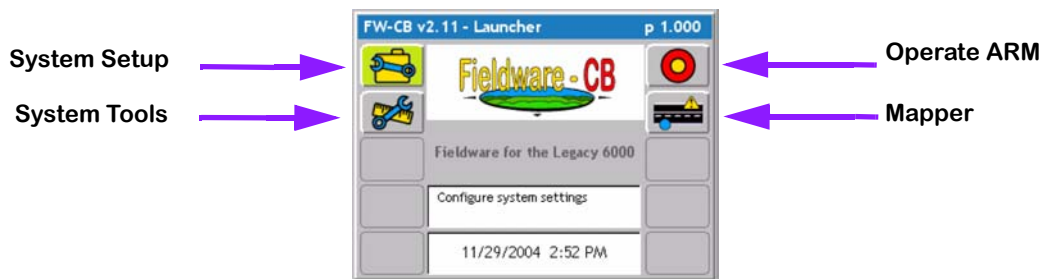

Figure 2-2: Main Launcher Page

Screen Navigation & Selection

An operator can easily navigate around the screen by using the buttons on the face of the Legacy 6000, or with the connection of a USB keyboard. The buttons on the face of the Legacy consist of four navigation arrows, escape (esp), enter, and ten function buttons (Figure 2-3). The ten function buttons, five down the left and five down the right will be the fastest way to navigate and select items on the screen. When using the USB keyboard the buttons on the keyboard have the same function as those on the screen (Figure 2-4).

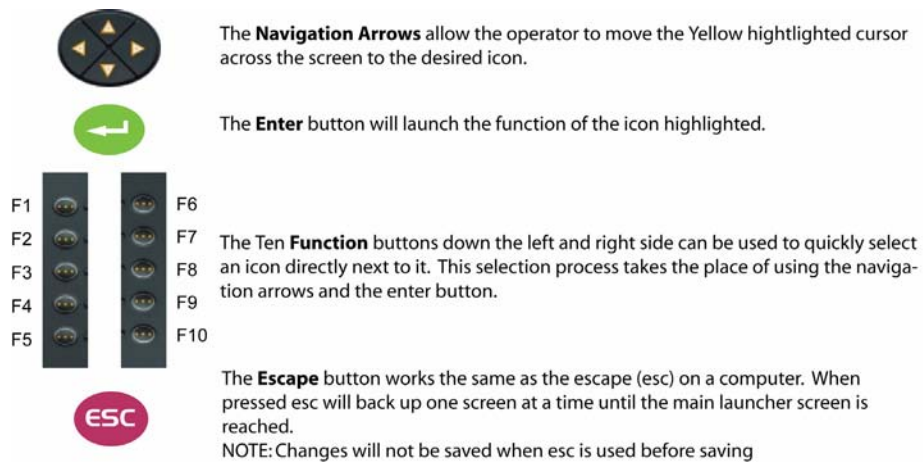

Figure 2-3: Legacy 6000 Screen Navigation & Selection Buttons

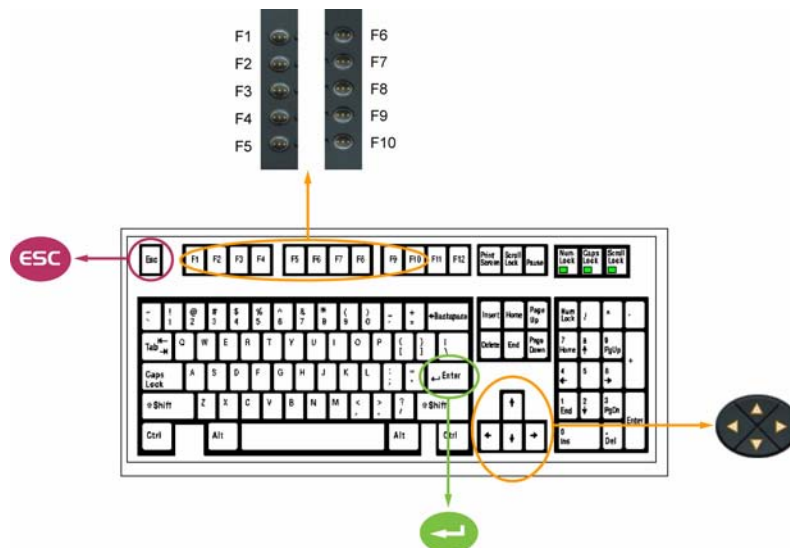

Figure 2-4: USB Keyboard Screen Navigation & Selection Buttons

Standard Pages

Three basic types of software pages are used in "Fieldware for the Legacy 6000", a Launcher page (Figure 2-5), a Setup Menu page (Figure 2-6), and a Data Entry page (Figure 2-7) and (Figure 2-8). Each is described in more detail below. Each of these page types has its own help window which displays pertinent information about a button or highlighted area of the page. Learning how to use each of these page types allows the competent operation of the Fieldware software.

Launcher Page

A Launcher page typically contains several smaller applications (programs) that are run (launched) from that Launcher page. For example, the Launcher page below, (Figure 2-5), is the System Setup launcher from the Main Launcher Page. Several setup applications, such as the Console and Product Control Module setup, can be accessed from here. In this Launcher page figure, the highlighted software button is GPS Receiver setup and the associated help text is displayed in the help window at the top of the page.



Figure 2-5: Example of a Launcher Page

Setup Menu Page

A Setup Menu page (Figure 2-6) is a page that contains all of the setup parameters associated with a particular setup theme, such as GPS Receiver. A Setup Menu page can be divided into three columns, Left, Center and Right. The Left and Right columns are made up of software buttons adjacent to a physical key on the console. The center column is a scrollable list containing the name of every setup parameter and its current value. Navigate to the center column using the up and down arrow keys on the console (Figure 2-1). To edit any of these settings, highlight the desired setting in the center column and press the enter key on the console. This action typically selects a Data Entry page (Figure 2-7) and (Figure 2-8).

Setup Wizard

Typically the top item in the center column list is a setup wizard. This setup wizard sequentially steps through each setup parameter Data Entry page, allowing the editing of that setting, and then continuing on to the next setup parameter. This is a convenient method for new users, who are unfamiliar with all of the setup parameters.

Setup Sub-Groups

In some Setup Menu pages there are sub-group buttons in the right and left columns. Pressing one of these displays only the setup parameters associated with that sub-group, in the center column. For example, in GPS Receiver setup (Figure 2-6) there are three sub-group buttons. The Globe button (right column) will display all setup parameters associated with GPS Receiver setup, the next button down is the sub-group for receiver accuracy. Pressing this button reduces the items in the center column to setup parameters associated with GPS accuracy, eliminating all of the items associated with the other sub-groups.

Exiting a Setup Menu Page

There are two ways to exit a Setup Menu page: "Save and Exit" and "Exit with out saving changes". To exit the setup with out saving changes, press the back arrow button located at the top of the left column. To exit and save any changes you made, press the forward arrow at the top of the right column. Either of these methods returns you to the Launcher page that the setup menu was accessed from.

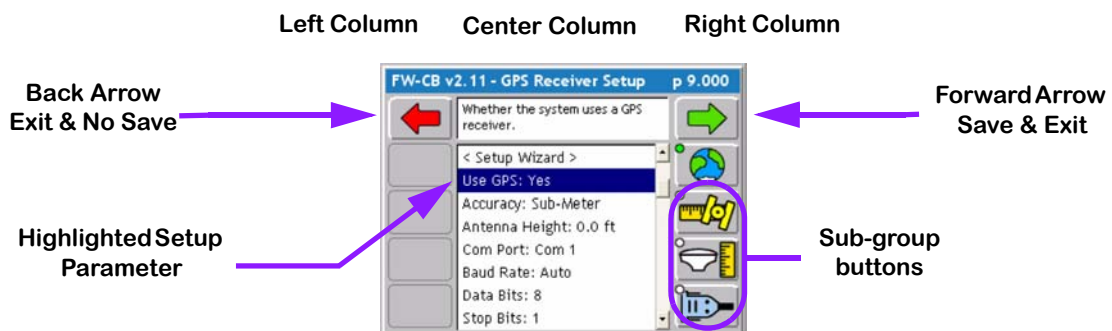

Figure 2-6: Example of a Setup Menu Page

Data Entry Page

Data Entry page may be an alpha-numeric entry or a pick list (Figure 2-7). The Data Entry page is also divided into three columns: Left, Center, and Right. The left and right columns contain software buttons, typically only the back and forward arrow buttons. The center column is the data entry dialog box. Use the arrow keys on the console to navigate around the Data Entry page. The bottom half of the Data Entry page is comprised of a text window with a white background. This window can contain a description of the current setting as well as some help text.

Pick List Data Entry

To select a setup parameter setting in a Data Entry page that employs a pick list in the dialog box, highlight the dialog box (center column) using the left or right arrow key. Using the up and down arrow keys spin through the available setting selections. When the desired setting is in view in the dialog box press enter to save the setting or press the forward arrow.

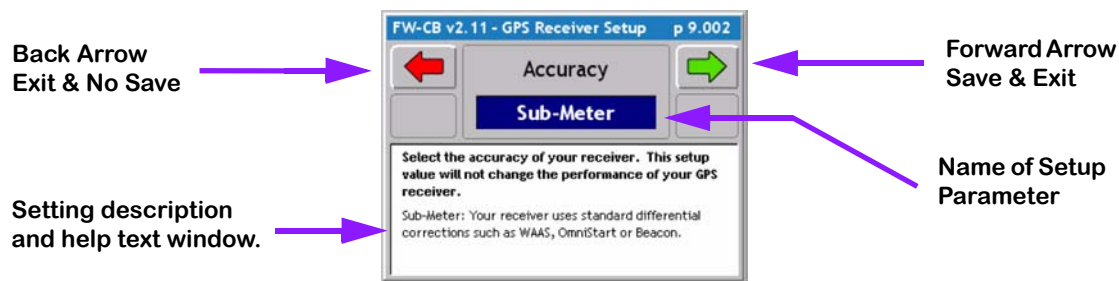

Figure 2-7: Example of Pick List Data Entry Page

Alpha/Numeric Data Entry

To enter a value in a Data Entry page that employs an alpha/numeric dialog box (Figure 2-8), highlight the desired character and use the up or down arrow key to spin through the alpha/numeric character list. When the desired character is in view in the dialog box press the right arrow key to move to the next character space in the dialog box. When the desired setting is in view in the dialog box press enter to save the setting or press the forward arrow.

If you are entering a numeric value, you can use the decimal point in the character set to set the number of digits to the left and right of the decimal point, (E.G. 0.254, 1.00, 10.0, 100.463).

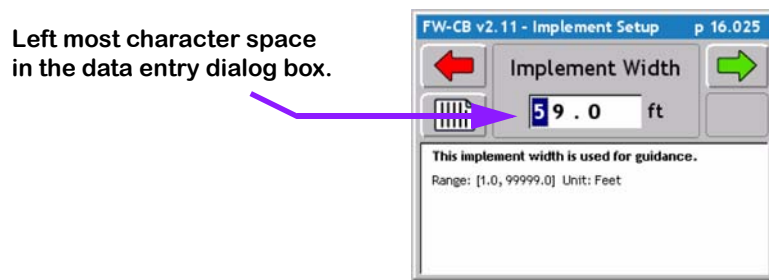

Figure 2-8: Example of Alpha/Numeric Data Entry

System Setup

The Fieldware System Setup allows the configuring of the Legacy 6000 to best suit job needs. To access the System Setup launcher press the top left button in the Main Launcher page see the left image in (Figure 2-9), the help text should say *Configure System Settings*. This brings up the System Setup Launcher page right image (Figure 2-9). The table below lists the current system components that can be configured. Each component is covered in more detail in sections below.

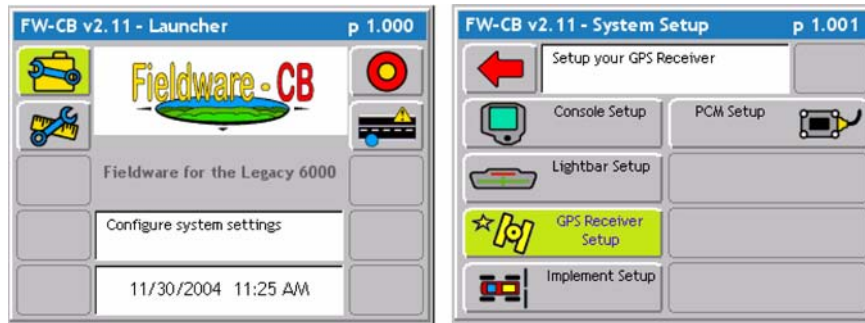

Figure 2-9: System Setup Page

Setup	Description
Console	Defines system environment variables such as units, language, date, and time.
Lightbar	Defines Swath lightbar settings and lightbar messages.
GPS Receiver	Allows you to configure your GPS receiver from the Legacy 6000 console.
PCM	Configures each Product Control Module that is connected to the Legacy 6000 system.
Implement	Defines the vehicle's implement, including implement width, number of swaths and sections.

Table 2-1: Current System Setup Components

Console Setup

Console Setup defines system environment settings (units, language, time) that are displayed on the console and used in the rate control and guidance applications.

To change any of the system environment settings, highlight the setting name, listed in the center column of the Setup page, and press enter. Use the Setup Wizard to walk through all setup options and select the appropriate settings. When done making changes, press the forward arrow to save and exit Setup. Press the back arrow to exit and not save any changes. This procedure will hold true for Console, Lightbar and GPS Receiver Setup.

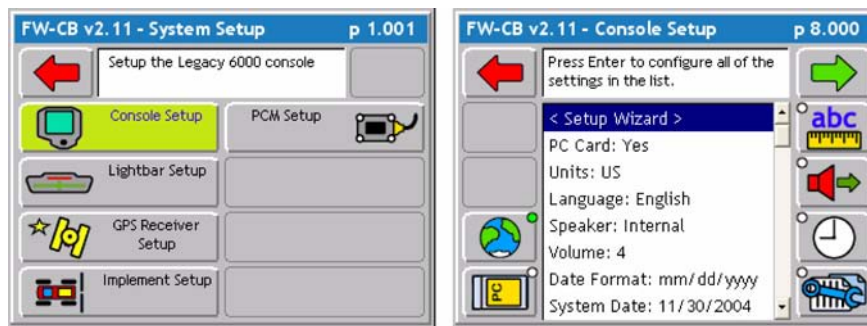

Figure 2-10: The Console Setup Menu Page

Setting	Description
PC Card	Indicates to the Legacy 6000 system that a PCMCIA data card is being used.
Units	Defines the system units: Metric or US.
Language	Defines the system language.
System Date	Sets the system date.
Date Format	Defines the date format that will be displayed on the console. Settings are MM/DD/YY or DD/MM/YY.
System Time	Sets the system time.
Time Format	Defines the time format to be displayed on the console. Settings are 12 hr. and 24 hr.
Time Zone	Sets the time zone the Legacy 6000 system is operating in.
Speaker	Sets the system speaker option: internal or external.
Volume	Sets the speaker volume.

Table 2-2: Console Setup Settings

Lightbar Setup

Lightbar setup defines how the Legacy 6000 console configures the lightbar. Lightbar setup parameters are listed in Table 2-3.

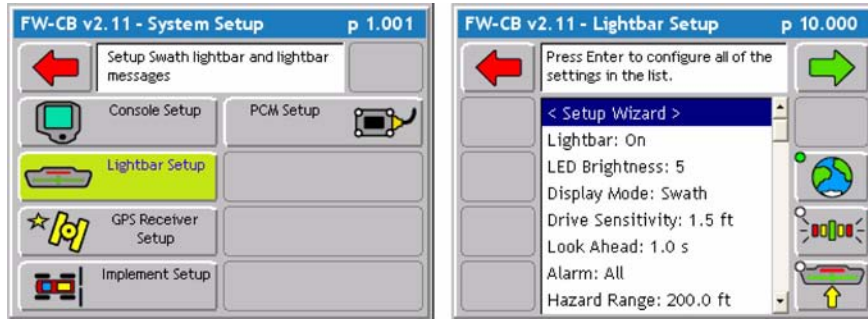

Figure 2-11: The Lightbar Setup Menu Page

Setting	Description
Lightbar	Defines which lightbar features are used. Settings are Text/Lights, Text Only, or Off.
LED Brightness	Sets the brightness level of the lightbar LEDs and text window.
Display Mode	Defines how the user interprets the row of LEDs on the lightbar. The center stack of Green LEDs can represent the current guideline (Swath Mode) or the vehicle (Vehicle Mode).
Drive sensitivity	Sets the distance that a single LED in the row of LEDs represents (Typically 1.5 feet).
Look Ahead	The number of seconds ahead of the vehicle that the cross track error is calculated at (Typically 2.0 seconds).
Alarm	Defines the situation in which the alarm sounds. Settings are Off, Alarm, Hazards, and All.
Hazard Range	Sets the distance prior to an impending feature (Hazard or Applied Area).
Parallel MSG 1 Parallel MSG 2 Parallel MSG 3	Defines which of several lightbar messages are displayed in the #1, #2, #3 MSG location. Choices are X-Track, Swath #, Heading Error, Ground Speed, Area Applied, Off, Application Rate, and X-Track/Swath#. Once a choice has been selected it will not appear as a option for the next two messages.
Curved MSG	Defines which of several lightbar messages are displayed in the #1 Curved MSG location. Only the Curved MSG is used when in Headlands guidance mode. Choices are Area Applied, Ground Speed, X-Track, Application Rate, and Off.

Table 2-3: The Lightbar Setup Settings

GPS Receiver Setup

GPS Receiver setup defines your DGPS accuracy and how the GPS receiver communicates with the Legacy 6000 console. GPS Receiver setup parameters are listed in Table 2-4.

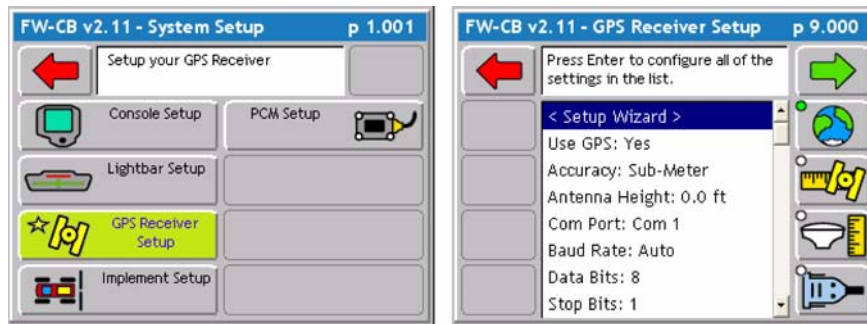

Figure 2-12: The GPS Receiver Setup Menu Page

Setting	Description
Use GPS	Defines whether the Legacy 6000 system is using GPS. If using GPS this setting must be set to Yes.
Accuracy	Defines the accuracy of the DGPS receiver. Choices are RTK and Sub-meter.
Com Port	Defines the com port that your GPS receiver is connected to.
Baud Rate	Defines the selected com port baud rate.
Data Bits	Defines the selected com port data bit setting.
Stop Bits	Defines the selected com port stop bit setting.
Parity	Defines the selected com port parity.

Table 2-4: The GPS Receiver Setup Settings

Implement Setup

Implement Setup is where the number of Swaths, number of Sections per Swath, and the physical relationship (distance and direction) of a Swath to the position of the GPS antenna are defined. Implement Setup is a step by step (Wizard fashion) process.

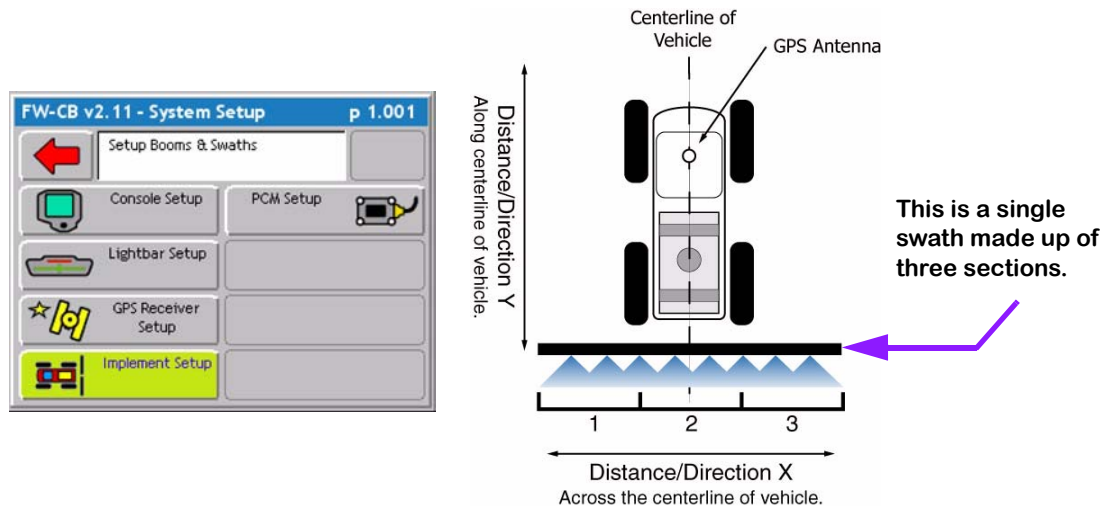

Figure 2-13: The Vehicle-Swath-GPS Antenna Relationship

The Vehicle Coordinate System

In order to properly capture the relationship between swaths and the GPS antenna on the vehicle, "Fieldware for the Legacy 6000" has defined a coordinate system based around the center line of the vehicle (Figure 2-13). Review this Vehicle Coordinate System prior to running Implement Setup. It is also a good idea to make all of measurements, such as distance from GPS Antenna to Swath, prior to running Implement Setup.

The X and Y Axes

In "Fieldware for the Legacy 6000", a vehicle has two axes: an X and a Y. The X axis runs perpendicular to the center line of the vehicle and the Y axis is the center line of the vehicle (Figure 2-13). Directions along the X axis are referred to as right and left, while directions along the Y axis are referred to as forward and back.

Location of GPS Antenna

The GPS Antenna must be mounted along the center line, the Y-Axis, of the vehicle (Figure 2-13).

Swaths and Sections

In version 2.11 of "Fieldware for the Legacy 6000" a vehicle can have as many as four swaths and up to 20 sections total across all swaths. A vehicle with a single swath divided into three sections is shown in Figure 2-13.

Entering the Implement Width

The first page in the Implement Setup process is the implement width (Figure 2-14). This width is used for guidance purposes and is considered the distance between guidelines. This width is typically determined by the vehicle swath or spread width. Setting the Implement width slightly smaller than the actual width reduces skips. Setting the Implement width slightly larger than the actual swath width reduces overlap. Setting the implement width to a width other than the actual width reduces the accuracy of the area applied.

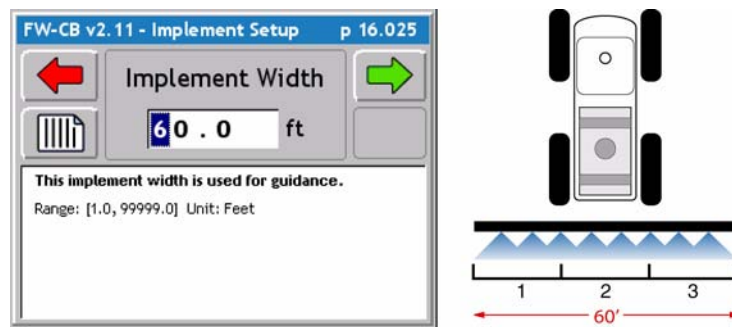

Figure 2-14: The Implement Width Page

The Implement Width page contains a Review Configuration button. Pressing this button brings up a page that details the current Implement configuration. No settings can be changed from this page (Figure 2-15).

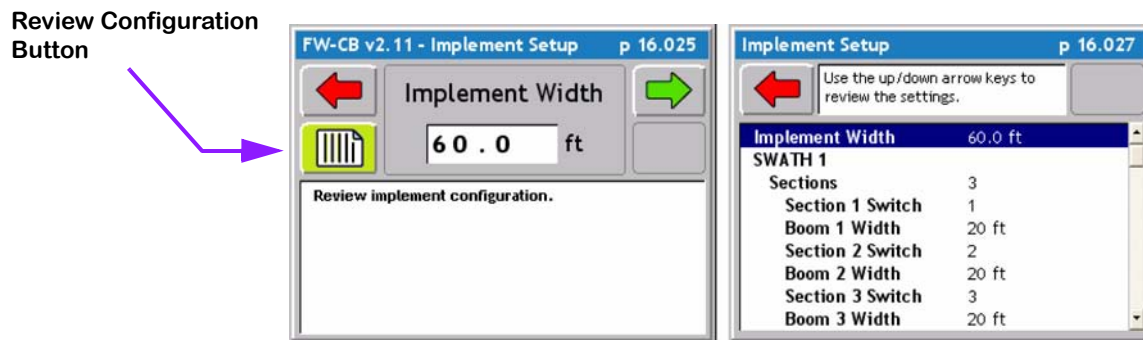

Figure 2-15: Review of Implement Configuration

Number of Swaths Page

Currently the maximum number of swaths that "Fieldware for the Legacy 6000" can handle is four. The Majority of applications will have One swath. For more on multiple swath applications and examples see

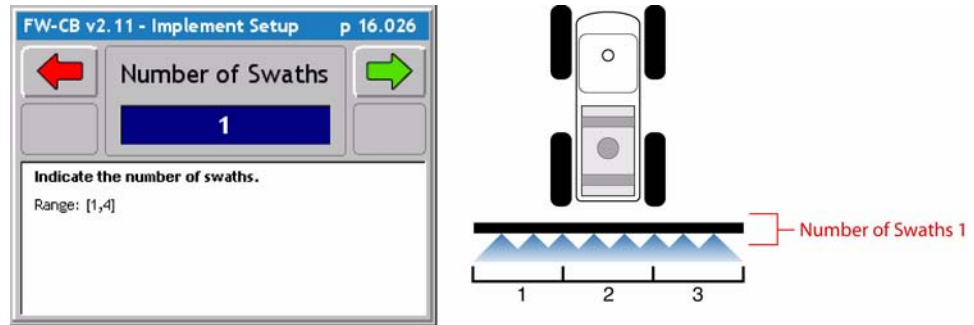

Figure 2-16: The Number of Swaths Page

Entering the Number of Sections in a Swath

The Sections page is where the number of sections in a swath are entered. The maximum number of sections is 20 (not 20 sections per swath, 20 sections for the entire system).



Swath sections are ordered left to right with respect to a forward facing vehicle. The left most section is assigned number 1 and section numbers increase moving to the right (Figure 2-17).

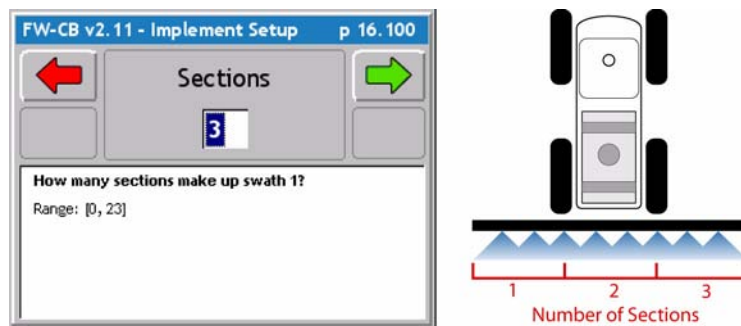

Figure 2-17: The Number of Sections in Swath 1 Page

Setting the Section to Switch Assignment

The Section to Switch page allows you to assign a physical boom switch to the current Swath Section. This allows the control of individual sections.

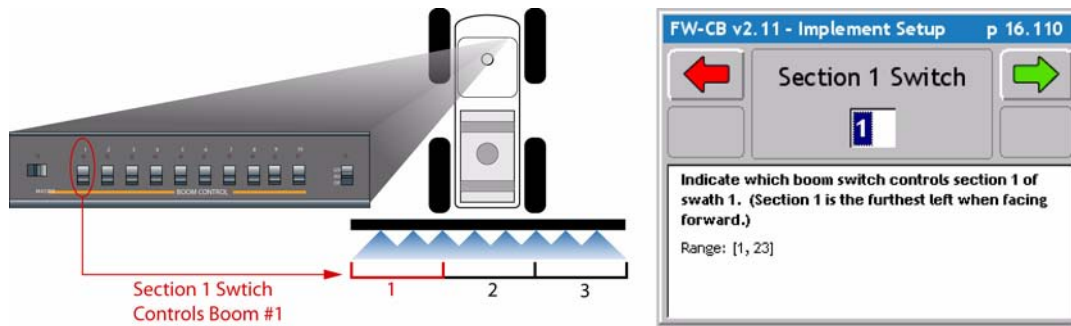

Figure 2-18: The Section to Switch Assignment Page

Entering the Section Width

The Section Width page is where the width of a section is entered. When the correct section width is entered, press the forward arrow button to move to the next setup page.



If there is more than one section for a swath, Implement setup will alternate between Section to Switch Assignment and Section Width until all sections have been completed.

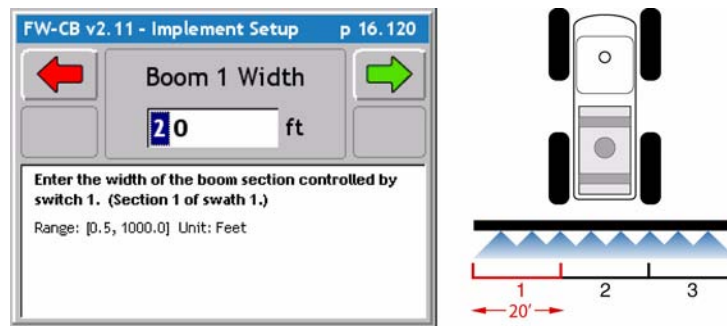

Figure 2-19: The Section Width Page

Entering the Offset Direction Y

The Y direction offset is the direction, (along the center line of the vehicle) from the GPS antenna to the center of a swath (Figure 2-20).

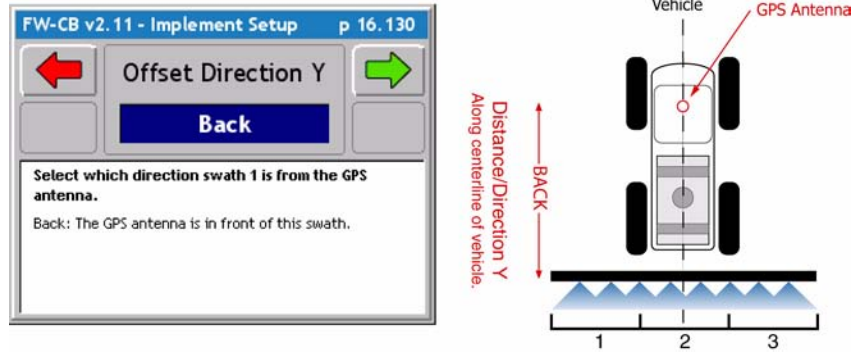

Figure 2-20: The Offset Direction Y Page

The Offset Distance Y

When the Y Offset Direction has been entered, enter the Y Offset Distance. This is the distance from the GPS antenna along the vehicle center line to the swath.

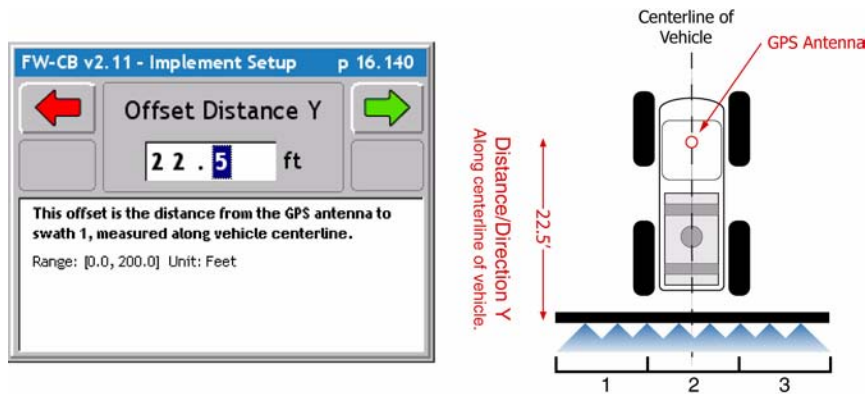

Figure 2-21: The Offset Distance Y Page

Entering the Offset Direction X

The Offset Direction X (Figure 2-22) is the direction perpendicular (left or right) of the vehicle center line that the center of a swath is offset. Typically this will be set to Centered, as most swaths are centered on the vehicle's center line.

If an Offset Direction X of either Right or Left is selected, the next setup page (Figure 2-23) will ask for the distance of this offset. If Centered is selected, there is no distance and therefore an input a distance is not asked for.

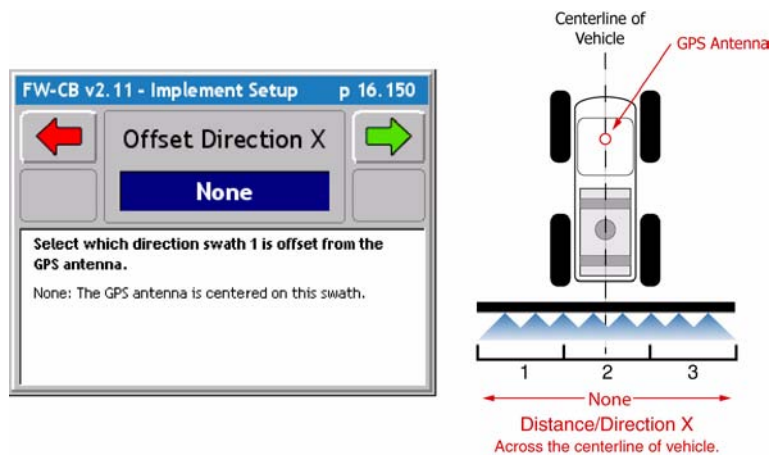

Figure 2-22: The Offset Direction X Page

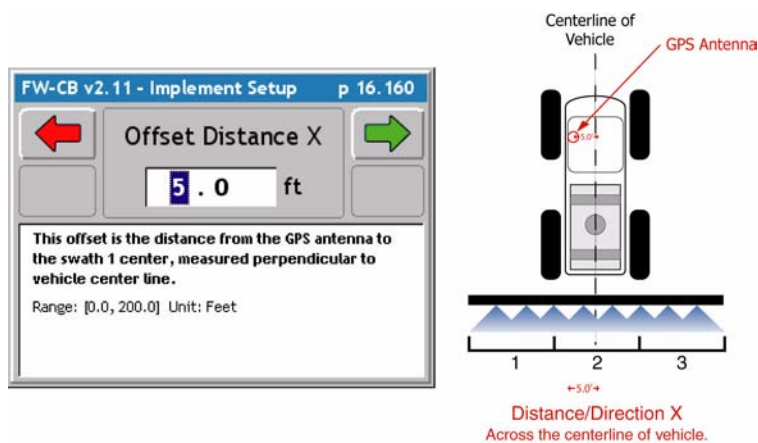

Figure 2-23: The Offset Distance X Page

Setting the PCM Assignment

The PCM Assignment page allows the assigning of a Product Control Module (PCM) to a swath or swaths. The PCM must be setup prior to assigning it to a swath. A swath can have a single PCM assigned to it or all PCMs assigned to it.

When a PCM has been assigned to a Swath, press the forward arrow button to move to the next setup page.

This completes the single swath setup. Implement Setup will loop through several of the previous setup pages based on the number of swaths entered and number of sections for each swath.

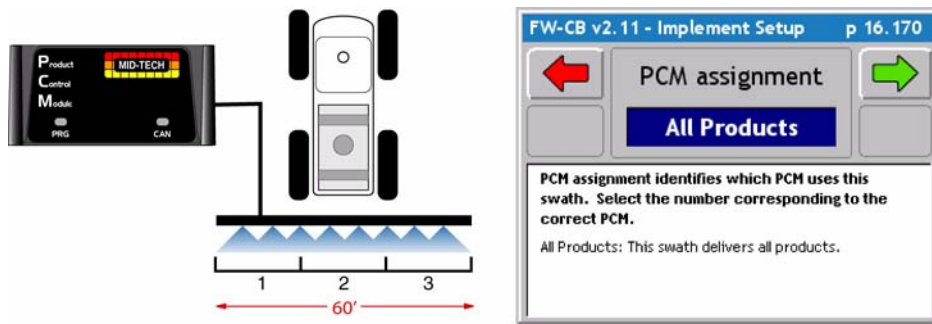

Figure 2-24: The PCM Assignment Page

Completing Implement Setup

When all swaths and sections have been properly setup, the last Implement Setup page is the Finish page. There are two buttons on the Finish page: a Review Configuration button and a Save to SSM (Switch Sense Module) button.

Pressing the Review configuration button will display all of the implement setup settings that have just been entered (Figure 2-15).

The Save to Switch Sense Module (SSM) button will send the current Implement configuration parameters to the Switch Sense Module.

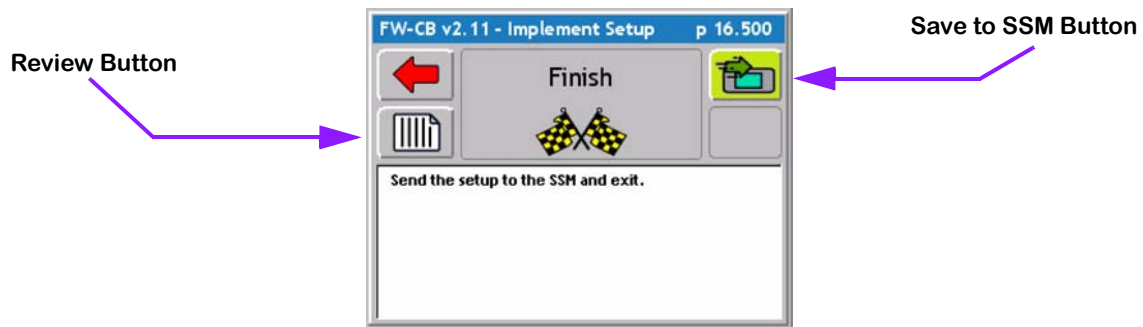

Figure 2-25: The Implement Setup Finish Page

Product Control Module (PCM) Setup

The Product Control Module (PCM) setup is used to configure a PCM that is connected to the Mid-Tech Legacy 6000 CAN Bus. A PCM can not be configured if it is not connected to the Mid-Tech CAN Bus.

Setting up a PCM is typically required in the following scenarios: The initial Legacy 6000 hardware installation, when an additional PCM is added to the system, or to modify an existing, already configured, PCM. PCM setup consists of ten Main Setup Headers, (Favorites, Application, Drive Type, Units, Primary Sensor, Secondary Sensor, Monitors 1, Monitors 2, Monitors 3, and Monitors 4) Table 2-5, each Header has detailed setup parameters to fit the operators application. Information entered in a PCM setup Main Setup Headers may effect subsequent PCM settings and pages. Review the setup procedure before running PCM setup. If in doubt, contact your Mid-Tech customer service representative.

To access PCM Setup, select System Setup from the main Launcher page. This brings up the System Setup page. From the System Setup page, select PCM Setup. This brings up the PCM Setup page. The PCM Setup page will have a button for each PCM the software detects on the CAN bus. If there is only one PCM connected this page will not appear and will advance directly to the First Main Setup Header (Favorite). Each button will display the PCM number, Serial Number and PCM Name (Figure 2-26). Select the desired PCM to be setup and press enter.

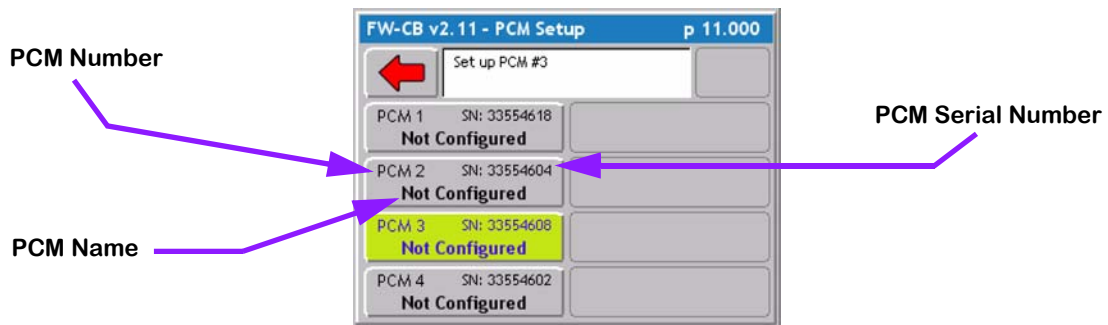

Figure 2-26: The PCM Setup Launcher Page



Page Name	Description
	Allows a setup configuration to be selected or saved.
	Defines the type of product application or device being controlled, such as Liquid or Granular.
	Select the drive circuit used to control the product delivery or device.
	Select the units used for the application rates.
	Defines the type of sensor used for the primary control function.
	Defines the type of sensor used for the secondary control function.
	Defines the type of sensor used as a monitor. There are four monitor pages. This sensor is not used for product control.
	Allows the PCM configuration to be saved as a favorite and updates the PCM with the new configuration.

Table 2-5: PCM Setup - Main Setup Headers

Selecting a PCM Setup Favorite

The first setup page is the PCM Favorite (Figure 2-27). When the operator configures all PCM Setup parameters the settings can be saved as a Favorite. Favorites are completed saved versions of PCM setup. Mid-Tech has taken the time to provide some very basic PCM setups for liquid and dry applications Table 2-6. To view all the default settings for the pre-created favorites (See “Appendix A - PCM Favorites Settings” on page A-1.) One of the favorites may come close to fitting your application, it will be very helpful to use the closest pre-created favorite to your application as a starting point and adjust as needed. When PCM setup is complete save the setup as your own personnel Favorite. This is very useful if the Legacy is used in more than one application. This feature will prevent the operator from setting up the PCM every time the application changes, just select the favorite created for the application and press the Finish flag, apply the settings and GO!

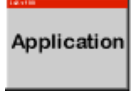
The default configuration is always the current configuration and is listed as <Loaded> in the dialog pick list. When creating a new configuration, name the configuration, at the end of the setup process, on the Finish page.

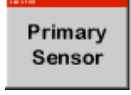
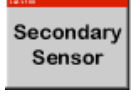
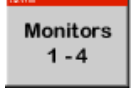
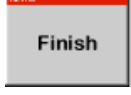
To view the settings of the loaded configuration, press the review button (Figure 2-27).

Select the desired favorite that best matches the application and press the Forward arrow to advance to the next PCM Setup page (Figure 2-28). If no other changes are required, press the Finish button and go directly to the last setup page “Finishing the PCM Setup” on page 2-38.

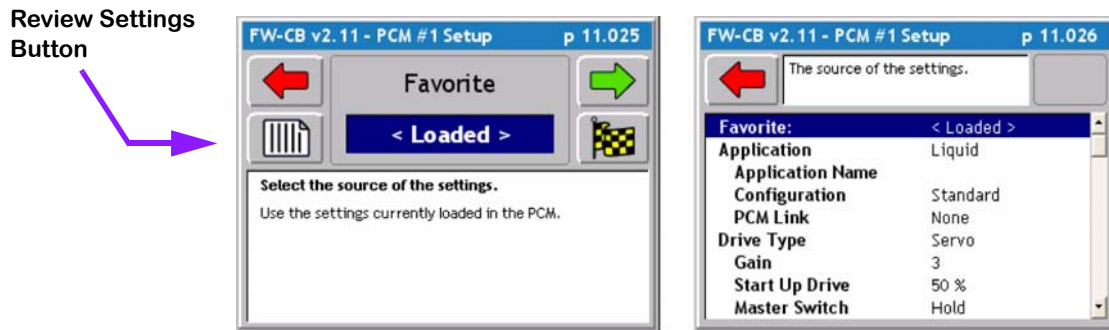

Figure 2-27: The PCM Setup Favorites Page

Favorites	Description
GRANC-A	Defines a granular application in Split-Drive with three monitors.
GRANPWM-A	Defines a granular application using a PWM valve.
GRANSERVO-A	Defines a granular application using a Servo valve with one Monitor (shaft).
GRANSERVO-B	Defines a granular application using a Servo valve with No monitor.
INJ-A	Defines an injection application.
LIQFLOW-A	Defines a liquid application using a flowmeter with one monitor.
SPINMOTOR-A	Defines a Shaft sensor used to control spinner speed.

Table 2-6: PCM Pre-Created Favorites

Setting the Application Type

The Application Setup page (Figure 2-28) allows the selection of the required type of product application. All other setup pages will be based on the type of application chosen on this page. There are five possible applications: Liquid, Granular, Seeder, NH3, and Motor.

For each Application type there is an additional Settings page. To access the Settings page, press the Settings button on the Application page (Figure 2-28). Typically it will not be necessary to change any parameters found in the Settings page.

Select the Application type and press the Forward arrow to advance to the next PCM Setup page.



When changing the application type, the Finish Flag button may disappear. This button disappears if the change in application type caused additional changes to other PCM setup parameters. It may be necessary to continue viewing the remaining setup parameters prior to finishing the PCM setup process. If no additional PCM parameter changes occurred, the Finish button is presented and a press of this button brings up the last setup page. From the Finish page, update the PCM with the new setup file.

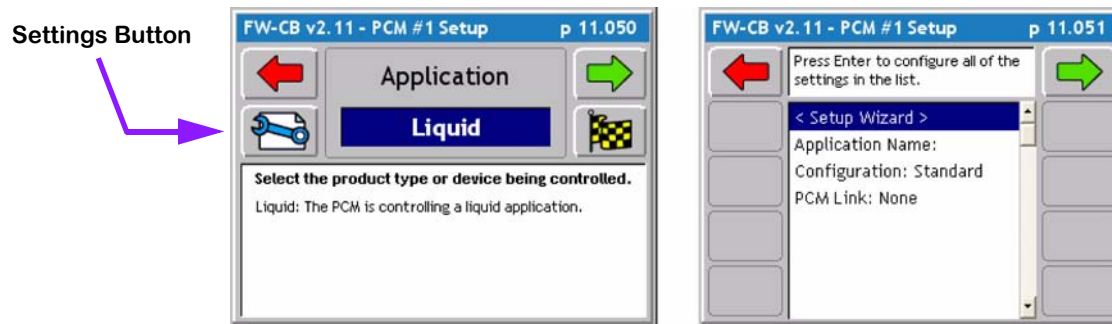

Figure 2-28: The Application Page

Application Type Options



Application Type Settings

All Application Types have the same setting options when the settings button is pressed, review (Table 2-7) for a detailed description of the settings. When the Application Type settings and parameters are selected, press the Forward arrow to advance to the next PCM Setup page

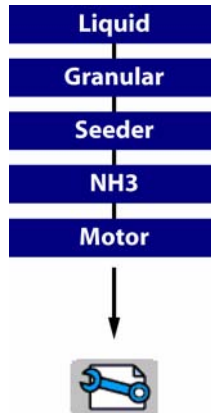

Application Settings	Description
Application Name	A user defined name used to label a particular application (PCM). Users typically label this the same as the PCM favorite name.
Configuration	Defines the relationship between the sensor and the product. Standard Liquid - All material that is recorded by the rate sensor is discharged through the boom. Standard Granular - Material shaft speed should change as booms are turned off. Split - Only used in a granular application. Material shaft speed does not change as booms are turned off. Reflow - Only used in a liquid application. Material from a closed boom valve is recirculated back to the tank or pump.
PCM Link	If more than one PCM is in use the PCM can be linked to one another. This is used if one product is dependent on the other product for proper application. When PCM's are linked and one would fail, both PCM's would shut down.

Table 2-7: Application Type Detailed Settings

Setting the Drive Type

The next PCM Setup parameter is Drive Type. This is the type of drive circuit used to control the delivery of a product. The list of available drive types depends on the Application selected in the previous setup page. Some Drive Types have an additional Drive Types Settings page, (See “Drive Type Settings” on page 2-26.), accessed from the Settings button on the Drive Type page.

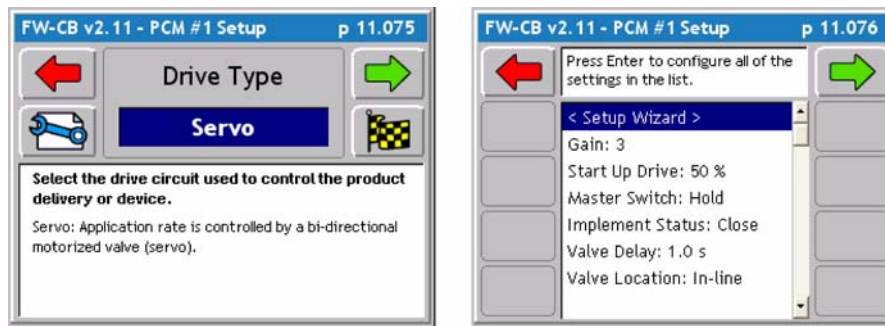
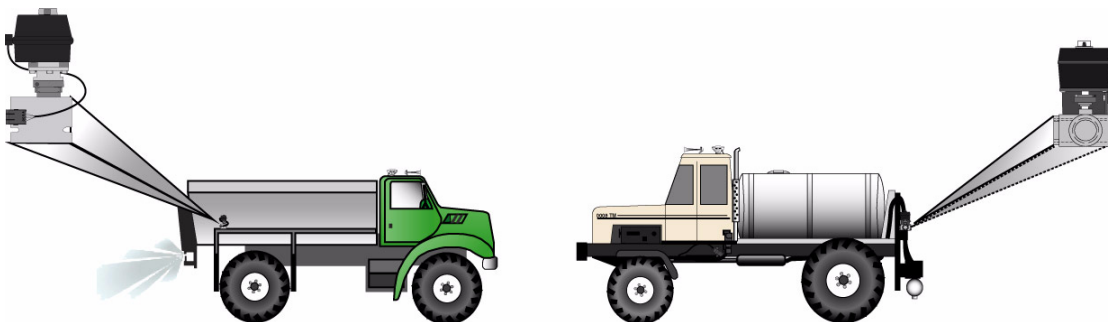

Figure 2-29: The Drive Type Page

Drive Type	Description
Servo	Application rate is controlled by a bi-directional motorized valve.
PWM	Application rate is controlled by a pulse-width modulated hydraulic valve.
DC Motor	Application rate is controlled by varying the speed of a DC motor. (Does not include injection)
Injection	Application rate is controlled by varying the speed of a direct injection pump.

Table 2-8: Drive Type Options



Drive Type Settings

Three of the Drive Types have setting options, Servo, Injection and PWM. Review (Table 2-9) for detailed Servo settings, (Table 2-10) for detailed PWM settings, and (Figure 2-11) for detailed Injection settings. When the Drive Type settings and parameters are selected, press the Forward arrow to advance to the next PCM Setup page

Servo

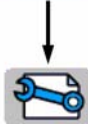

Servo Settings	Description
Gain	Defines the speed at which the PCM reacts to an off target condition. Decrease to postpone reaction and Increase to speed up reaction. (Gain setting too high can result in oscillation)
Start Up Drive	Defines the level used to open valve from full closed position. Increase if valve open too slowly and decrease if valve opens too quickly.
Master Switch	Control valve response to all booms off. Hold - Control valve will hold in the same position Closed - control valve will drive full close
Implement Status	Defines control valve response when implement status is open (Off) Hold - Control valve will hold in same position Closed - Control valve will drive full closed
Valve Delay	Enter delay in resuming control after turning all booms on. When the control valve is set to close this feature is activated when resuming control and the rate exceeds the target rate the valve will delay control for the set value.
Valve Location	Defines the location of the control valve in the plumbing (In-Line or Bypass). Also used with combination in-line / bypass valve like the Autorange and most hydraulic servos.

Table 2-9: Drive Type -Servo Detailed Settings

PWM



PWM Settings	Description
Gain	Defines the speed at which the PCM reacts to an off target condition. Decrease to postpone reaction and Increase to speed up reaction. (Gain setting too high can result in oscillation)
Frequency	Defines the frequency of the drive signal specified by the manufacturer.

Table 2-10: Drive Type - PWM Detailed Settings

PWM Settings	Description
Minimum Duty Cycle	Defines the min. duty cycle the valve will respond to, specified by the manufacturer.
Maximum Duty Cycle	Defines the max. duty cycle the valve will respond to, specified by the manufacturer.
Ramp Time	Defines the time it takes the valve to go from min. duty cycle to max. duty cycle. Decrease if the valve reacts too slowly when off target. Increase if control reacts too quickly (overshooting target rate).
Dither	Prevents valve from sticking. This value is specified by the manufacturer.
Master Switch	Control valve response to all booms off. Hold - Control valve will hold in the same position Closed - Control valve will drive full close Resume - Control valve will close when booms are turned off, but will resume at the last duty cycle setting when booms are turned on again.
Implement Status	Defines control valve response when implement status is open (Off) Hold - Control valve will hold in same position Closed - Control valve will drive full closed Resume - Control valve will close when booms are turned off, but will resume at the last duty cycle setting when booms are turned on again.
Valve Delay	Enter delay in resuming control after turning all booms on. When the control valve is set to close this feature is activated when resuming control and the rate exceeds the target rate the valve will delay control for the set value.

Table 2-10: Drive Type - PWM Detailed Settings

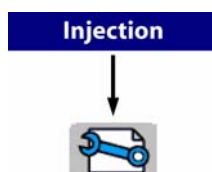

Injection Settings	Description
Prime Volume	Define the amount of liquid needed to prime the pump. This is the volume needed to fill plumbing lines from chemical tanks to the injection point, use the formula below to calculate the Prime Value. The Prime feature is located on the ARM launcher page (See "Prime Injection System" on page 3-25.)

Table 2-11: Drive Type - Injection Detailed Settings

Calculating the Prime Value

$$(Line\ diameter/2) \times 3.1416 \times Line\ length \times 0.5541 = Volume\ in\ Fluid\ Ounces$$

Setting the Units

When the Drive Type is selected, the next PCM Setup page is the Units page (Figure 2-30). The available units are based on the Application and Drive Type selected. There is an additional page associated with the Units page. This is the Control Basis page (Figure 2-30) right image. The Control Basis page determines whether the units available to you are Area based, Time based, or Distance based. Set this parameter prior to selecting the application units. When the Control Basis and Units parameters are selected, press the Forward arrow to advance to the next PCM Setup page

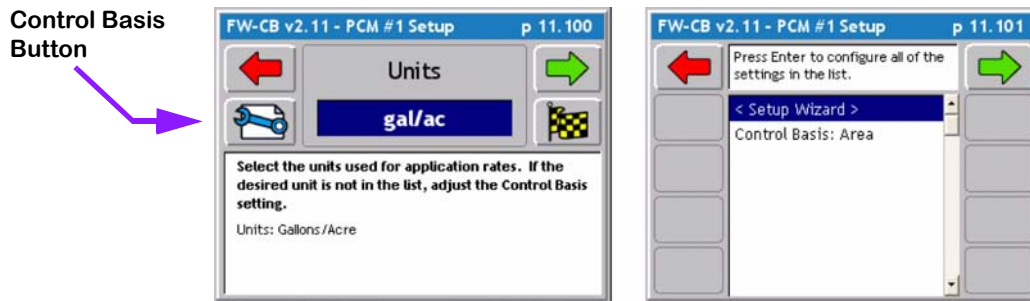
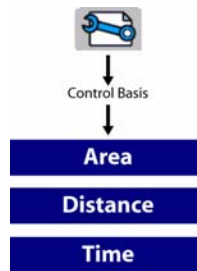

Figure 2-30: The PCM Setup Units Page



Application Types	Description
Liquid	Area - gal/ac - gal/1000ft ² - gal/100yd ² - l/ac Distance - gal/lmi Time - gal/min
Granular	Area - lb/ac - lb/1000ft ² - lb/100yd ² - tn/ac - kg/ac Distance - lb/mi - lb/lmi - tn/lmi - tn/mi Time - lb/min - tn/h -
Seeder	Area - lb/ac - sd/ac - tubers(tb)/ac - kg/ac
NH3	Area - lb/ac - kg/ac
Motor	Time - rpm
Injection	Area - fl oz/ac - fl oz/1000ft ² - fl oz/100yd ² - l/ac Distance - fl oz/lmi Time - fl oz/ min

Table 2-12: Application Type Options

Selecting the Primary Sensor

The Primary Sensor is the type of sensor used for the primary control function. The Primary Sensor types available in this pick list are based on the Application type selected. Each Primary sensor type has an associated Settings button (Figure 2-31) which goes to the Sensor Settings page (Figure 2-32). The Sensor parameters depend on the type of Primary Sensor selected.



Each PCM has six input sensors labeled A through F. Sensor inputs A - D are digital and sensor inputs E and F are analog. Your PCM CAN Bus cable harness comes with the sensor input lines labeled A - F. You can set the input line for a sensor in the Sensor Settings page.

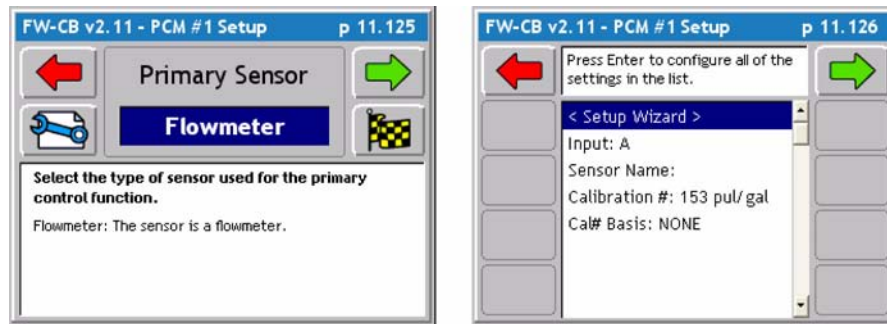

Figure 2-31: The Primary Sensor Page

Application Type	Primary Sensor Options
Liquid	Flowmeter, Pressure Digital, and Pressure Analog
Granular	Granular
Seeder/Motor	Shaft
NH3	Flowmeter
Injection	Injection

Table 2-13: Primary Sensor Options

Primary Sensor Settings

Primary Sensors Flowmeter, Granular, Injection and Shaft have detailed settings that are the same. Review (Table 2-7) for a detailed description of the settings. The two other Primary Sensors, Pressure Digital and Pressure Analog, have the initial settings as well as an sub settings. To access the sub settings locate the two Settings Buttons on the right side of the screen, use the two buttons to swap between settings.(Figure 2-32). Review (Table 2-14) for a detailed Description of the initial settings and (Table 2-15) for a detailed description of the sub settings for Pressure Digital and Pressure Analog sensors. When the Primary Sensor settings and parameters are selected, press the Forward arrow to advance to the next PCM Setup page

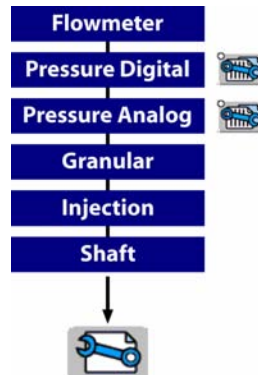

Sensor Settings	Definition
Input	Defines digital and analog sensors. Sensor inputs A-D are digital (flowmeter, and slot sensors) and Sensors E-F are analog (pressure).
Sensor Name	A user defined name used to label a particular sensor or monitor. This information is not stored in the PCM and is used for messaging to the user only.
Calibration Number	Enter calibration number in units specified, this number is normally found on the sensor. Physical calibration will further fine-tune this number. For NH3 applications (See "Appendix C - NH3 Application" on page C-1.)
Cal# Basis	Table of preset calibration numbers. This can be used to rapidly change a calibration number. See Appendix B for Cal# Basis setup.
Nozzle Constant	Only use for Pressure application. Enter the gal/min rating of your nozzle at 10mph at 30psi

Table 2-14: Primary Sensor Settings

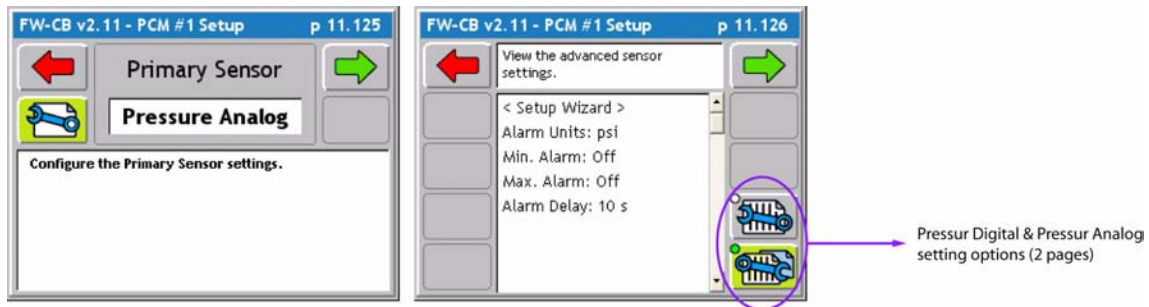

Figure 2-32: Pressure Digital & Analog Sub Settings Pages



Sensor Settings	Definition
Alarm Units	Pounds Force / Square Inch (PSI)
Min Alarm	Defines the limit below which the min. alarm will be active.
Max Alarm	Defines the limit above which the max. alarm will be active.
Alarm Delay	Defines the duration the alarm condition must exist before triggering tan alarm.
Sensor Output	Define the output signal type of the sensor. Contact the machine supplier for this information.

Table 2-15: Primary Sensors - Pressure Digital & Analog Sub Settings

Selecting the Secondary Sensor

The Secondary sensor is used in conjunction with a Primary sensor. The Secondary Sensor types, available in this pick list, are based on the Application type and Primary Sensor type selected (Figure 2-33). Each Secondary sensor type has a Settings Button which brings up the Sensor Settings page. The Secondary Sensor parameters depend on the type of Primary Sensor selected (Table 2-16).



Each PCM has six input sensors labeled A through F. Sensor inputs A - D are digital and sensor inputs E and F are analog. The PCM CAN Bus cable harness comes with the sensor input lines labeled A - F. The input line for a sensor can be set on the Sensor Settings page.

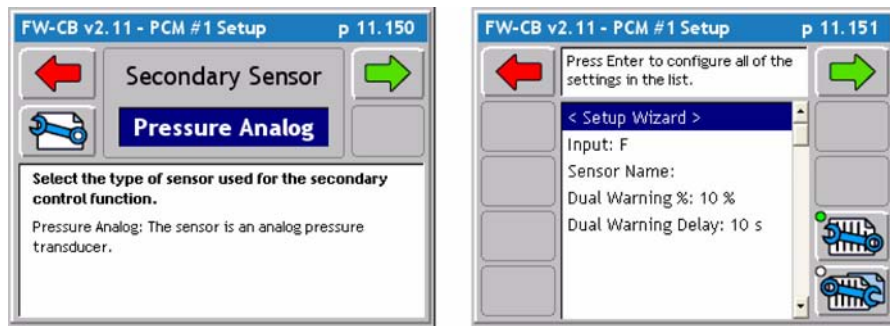

Figure 2-33: The Secondary Sensor Page

Primary Sensor	Secondary Sensor Option
Flowmeter	None
Pressure Digital	Pressure Digital
Pressure Analog	Pressure Analog
Granular	Granular
Shaft	Shaft
Injection	None

Table 2-16: Secondary Sensor Options

Secondary Sensor Settings

Secondary Sensors Granular, Shaft, Pressure Digital, and Pressure Analog have detailed settings that are the same. Review (Table 2-17) for a detailed description of the settings that are the same. The two Pressure Sensors, Pressure Digital and Pressure Analog, have the initial settings as well as an sub settings. Accessing the sub settings locate the two Settings Buttons on the right side of the screen, use the two buttons to swap between settings. see (Figure 2-32) above. Review (Table 2-18) for a detailed description of the sub settings for Pressure Digital and Pressure Analog Secondary Sensors. When the Secondary Sensor settings and parameters are selected, press the Forward arrow to advance to the next PCM Setup page

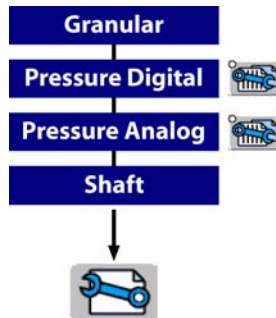

Sensor Settings	Definition
Input	Defines digital and analog sensors. Sensor inputs A-D are digital (flowemeter, and slot sensors) and Senors E-F are analog (pressure).
Sensor Name	A user defined name used to label a particular sensor or monitor. This information is not stored in the PCM and is used for messaging to the user only.
Dual Warning%	Defines the maximum acceptable % difference between the primary and secondary sensor outputs before the operator is warned.
Dual Warning Delay	Defines the time that the primary and secondary sensors outputs can exceed the dual warning % before initiating the alarm.

Table 2-17: Secondary Sensor - Settings

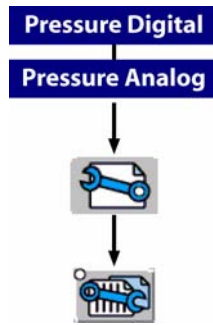

Sensor Settings	Definition
Alarm Units	Pounds Force / Square Inch (PSI)

Table 2-18: Secondary Sensor - Sub Settings

Selecting a Monitor

A Monitor is a sensor that is not a Primary or Secondary sensor and is used to monitor the status of some element of the application delivery system, such as RPMs on a shaft sensor. Up to four monitor sensors can be used in the delivery system. The Monitor types available in this pick list (Figure 2-34) are based on the Application, Primary sensor, and Secondary sensor types selected. Each Monitor type will have an associated Settings button which brings up the Monitor Settings page right image in (Figure 2-34). The Monitor sensor parameters depend on the type of Monitor sensor selected. Review (Table 2-19) for a list and description of the Monitor options.

PCM setup contains four Monitor setup pages; Monitor 1 thru Monitor 4. It is not necessary to setup four monitors. Select the monitor(s) used and press the forward arrow to save the settings. If there is no monitor, select the None setting and continue to the next page.



Each PCM has six input sensors labeled A through F. Sensor inputs A - D are digital and sensor inputs E and F are analog. The input line for a sensor can be set on the Sensor Settings page.

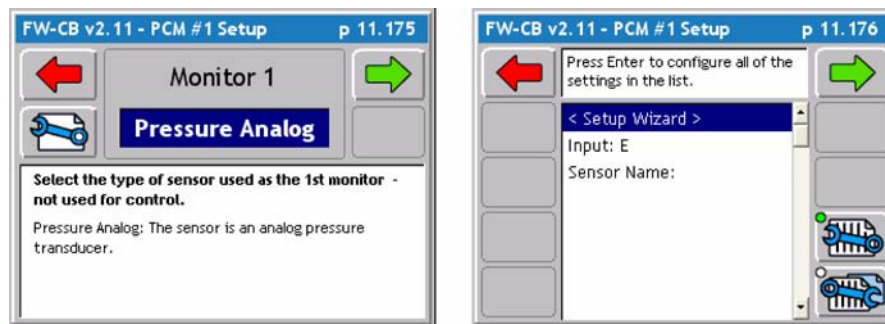

Figure 2-34: The Monitor Page

Monitors	Description
Shaft	Monitor a shaft rotation speed.
Product Detect	Monitor that product is discharging.
Low Bin	Monitor low product level left to apply.
Status	Monitor engaged or disengaged status.
Pressure Digital	Monitor pressure related or not related to application.
Pressure Analog	Monitor pressure related or not related to application.
Flowmeter	Monitor flow of liquid using a flowmeter.

Table 2-19: Monitor Options

Monitor Settings

Monitors Shaft, Product Detect, Low Bin, Status, Pressure Digital, Pressure Analog, and Flowmeter have detailed settings that are the same. Review (Table 2-20) for a detailed description of the settings that are the same. All Monitors have initial settings as well as an sub settings. Accessing the sub settings locate the two Settings Buttons on the right side of the screen, use the two buttons to swap between settings.see (Figure 2-34) above right image to locate the two buttons. Review (Table 2-21) and (Table 2-22) for a detailed description of the sub settings for all Monitors. When the Monitor settings and parameters are selected, press the Forward arrow to advance to the next PCM Setup page

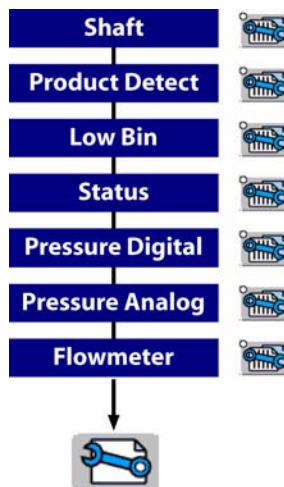

Monitor Settings	Description
Input	Defines digital and analog sensors. Sensor inputs A-D are digital (flowmeter, and slot sensors) and Sensors E-F are analog (pressure).
Sensor Name	A user defined name used to label a particular sensor or monitor. This information is not stored in the PCM and is used for messaging to the user only.
Calibration #	Enter calibration number in units specified, this number is normally found on the sensor. Physical calibration will further fine-tune this number.

Table 2-20: Monitors - Initial Settings

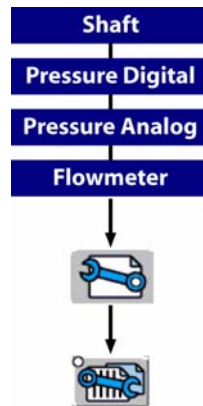

Monitor Sub-Settings	Description
Alarm Units	Pressure - psi Flowmeter - gal/min Shaft - rpm
Min. Alarm	Defines the limit below which the min. alarm will be active.
Max. Alarm	Defines the limit above which the max. alarm will be active.
Alarm Delay	Defines the duration the alarm condition must exist before triggering tan alarm.

Table 2-21: Monitor - Sub Settings

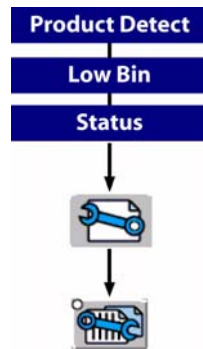

Monitor Sub-Setting	Description
Alarm Status	Off - Disabled Low - Sensor state goes low to trigger alarm. Contact the sensor or machine supplier for this information. High - Sensor state goes high to trigger alarm. Contact the sensor or machine supplier for this information.
Alarm Delay	Defines the duration the alarm condition must exist before triggering tan alarm.

Table 2-22: Monitor - Sub Settings

Finishing the PCM Setup

The final page in the PCM setup process is the Finish page (Figure 2-35). From the Finish page, select the Review all settings button to confirm setup is accurate with the machines application (Figure 2-36). Next from the Finish Page, save the PCM setup to a file for use later (See “Saving the PCM Setup to a File” on page 2-39.)

PCM setting can be directly applied to the PCM without saving by selecting the Send Settings to PCM button (Figure 2-35). The PCM will use the changes made during application. If a new application is needed and the PCM favorite or settings need to be changed all settings previous will be lost. Saving the PCM favorites take very little time and can save much time in the future.

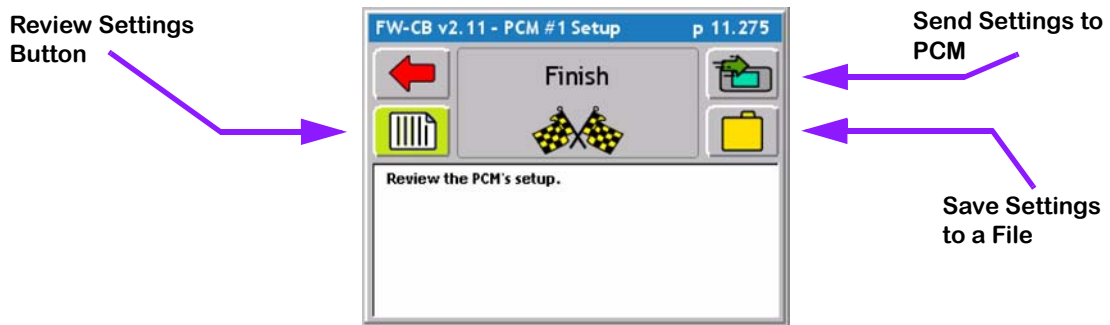

Figure 2-35: The PCM Setup Finish Page

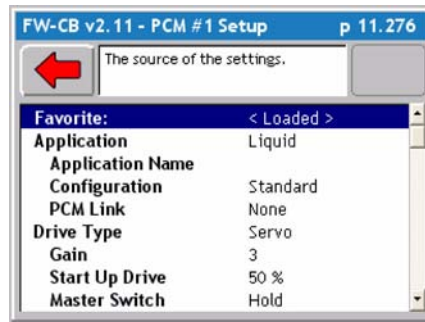

Figure 2-36: The PCM Setup Summary Page

Saving the PCM Setup to a File

Pressing the Save to a File button in the Finish page takes you to a Save As page (Figure 2-37) right image. The Save As page allows the naming of the PCM Setup file, such as My Sprayer. Once the PCM setup settings have been saved by pressing the green forward arrow after entering a name, this name will appear as a PCM favorite. This helps to quickly set PCM settings without going through each step. The next time these settings are needed select the favorite from the pick list and proceed by pressing the finish flag and all settings will be updated.



If updating an existing favorite and the operator wants to save the favorite as the same name, select the Favorite Folder button and find the favorite to be updated. Press the green forward arrow to save the settings

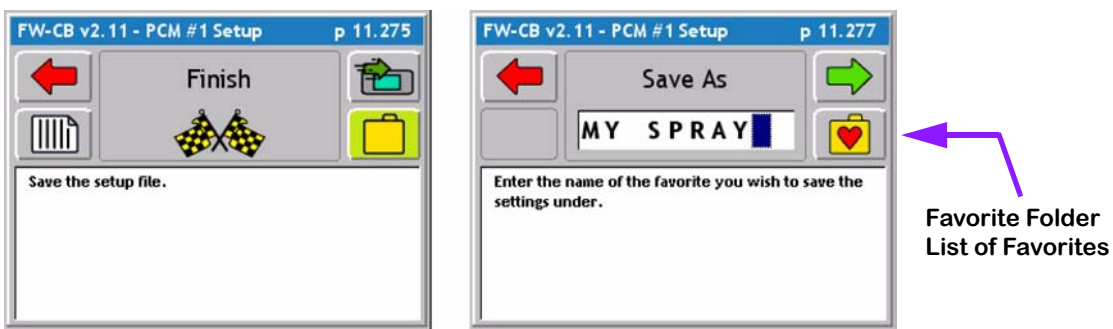

Figure 2-37: The PCM Setup Save As Page

Chapter Notes

Chapter 3 - Real-time Setup

Setting up Fieldware ARM for the Legacy 6000.

Software Version 2.11

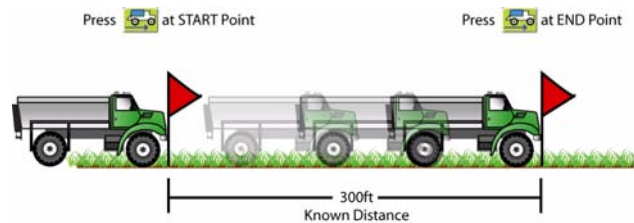

Operation Overview

When the System Setup process is complete, product application setup can begin. This is accomplished by pressing the ARM Bullseye located in the Fieldware Main Launcher page (Figure 3-1).

Prior to actually starting product application it is necessary to follow a short setup process. The steps in this process will vary based on how the software is setup, how many products are being applied, and most importantly whether the delivery system has been calibrated. This Chapter covers Calibration, Job Report (Weather and Soil conditions), ARM setup (date Storage files), Product setup. When ARM is setup properly product application can begin. Prior to starting real-time product application we recommend that (See "Chapter 4 - Real-time Operation" on page 4-1.) be reviewed.

The first time through these operate setup steps will take the longest amount of time. When the system has been calibrated and are file naming and product setup is understood, these operate setup steps can be accomplished in just a minute or two. Table 3-1 outlines the operate setup steps. Each step listed in the table is described in more detail in specific sections of this chapter.



Figure 3-1: Fieldware Main Launcher







Step	Description
	<p>Job: When the ARM Bullseye button is pressed, the Job page appears. Select or create the desired job. A PC Card must be inserted in the console to store a job. Press the forward key to continue to the ARM Launcher page.</p>
	<p>System Calibration: If the delivery system (PCMs) has not been calibrated it will be necessary to do this prior to starting product application. Distance calibration can also be accomplished here. If the system is calibrated, skip this step.</p>
	<p>Job Report: If an application report will be generated when the job is complete, it will be necessary to run Job Report to enter Weather, Crop, Field and Soils information.</p>
	<p>ARM Setup: This is where all files to be generated for the current job are automatically named. There are two ARM settings: Auto Hold and System Delay. When these settings are selected, they may not need to change. If the auto-named files are satisfactory, skip ARM setup.</p>
	<p>Product Setup: Allows the assigning of a products name, density and starting quantity to a PCM. If using a prescription map, the product name can be automatically extracted from the prescription file. Five preset application rates (A-E) can also be defined.</p>
	<p>When the above steps are accomplished and the console is properly setup, begin product application by pressing the ARM Bullseye. (See “Chapter 4 - Real-time Operation” on page 4-1.).</p>

Table 3-1: Start Product Application Process

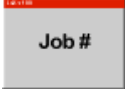
Starting a Job

Pressing the Bullseye button in the Fieldware Main Launcher brings up the Job page (Figure 3-2). If no PC card will be used and the Console Setup PC Card setting is set to NO, (see "Console Setup" on page 2-8), no Job number is asked for (see "No PCMCIA Card Setup" on page 2-6). A PC card is necessary in order to have a job number and save files.

When a Job is created a folder is created on the PC card labeled with same name. All files related to this job (Record, Guideline, Boundary, and Map Object) will be stored in this folder. These files are talked about in more detail (See "ARM Setup Detailed Description" on page 3-32.)

There are three methods for entering/selecting a job name.

Creating a New Job

To create a new job, press the Create Job button in the Job page (Figure 3-2). This brings up the Create a Job page. There are two methods of creating a job: manually and automatically (Figure 3-3).

Selecting an Existing Job

From the Job page (Figure 3-2), select an existing Job by using the up and down arrow keys. An existing Job has an associated file folder located on the PC card. The name of the job folder is the same as the job name.

Creating a Job Based on an Existing Job

A new job can be created based on the settings of an existing job. This helpful when starting a new job and no settings need to be changed. This allows the operator to create a new job and GO! To do this, select the desired job to base the new job from. Press the (Create a job off last job settings) button see (Figure 3-2). Create a new job name or auto name the job and then press the green forward arrow. All settings from previous job can now be viewed in from the ARM launcher page or press the ARM bullseye to start application based on last job settings.

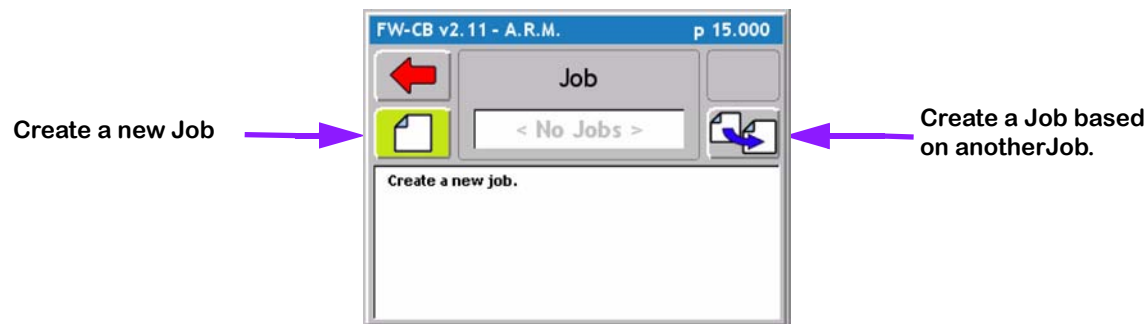

Figure 3-2: The Job Page

Manually Naming a Job

From the New Job Name page (Figure 3-3). Using the arrow keys enter the name of your job. It is not necessary to use all numbers in the job name. It can contain alpha-numbers characters. When the desired job name is entered, press the Forward Arrow to save the name and return to the Job page.

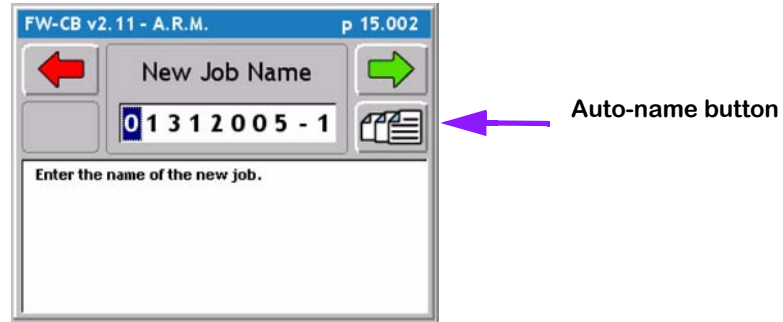

Figure 3-3: The Job Name Page

Automatically Naming a Job

The second method to create a job is to press the Auto-name button in the Create Job page. This will name the job based on the current date followed by the number that job is for the day. Therefore the first job on January 31st 2005 would automatically be named 01312005-1. The second job for the same day would be named 01312005-2.

No PCMCIA Card Setup

If no PC Card is setup in Console setup there is no prompt for a Job name when starting ARM. Instead the opportunity is given to reset some product related volumes and area totals (Figure 3-4), (Table 3-2).

Settings	Description
None	No volume or area totals stored in the PCM will be reset.
Total Reset	This will reset the field area, field volume and total volume stored in all PCMs to zero.
Field Rest	This will reset the field area and field volume stored in all PCMs to zero.

Table 3-2: The Rest Page Settings

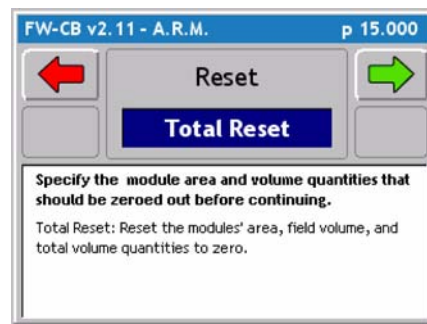

Figure 3-4: The Reset Page

ARM Launcher

When the appropriate Job name has been selected, press the Forward Arrow in the Job page to move to the ARM Launcher page (Figure 3-5). Several applications can be launched from this page that are required prior to starting up real-time product application. Each real-time setup application is discussed in detail below.



Figure 3-5: The ARM Launcher Page

No PCMCIA Card Setup

If the PC Card setting in Console Setup is set to NO, the ARM Launcher looks slightly different. Because no data is stored to the PC cards there is no need to name any files or setup any report information that would be stored in the (.RCD) file. Therefore the Job Report application will not be included, and any file selections in ARM Setup will not be included.



Figure 3-6: ARM Launcher (No PC Card)

Performing a Calibration

Introduction

This section describes the sensor calibration procedures that are required prior to performing accurate product application. Each sensor calibration is discussed in detail below, and each follows a wizard step by step process. The “Fieldware for the Legacy 6000” is capable of performing the following calibrations:

Distance/Speed, Liquid Pressure, Granular, Liquid Based Flow meter, NH3 Flow meter, Seeder.

All calibrations (except status monitors) result from a comparison of an actual value and a reported value. Calibration units are based on the units selected in PCM Setup. Prior to calibration, the PCM must be setup using PCM setup.

The Common Calibration Procedure

The calibration procedure for the application types Granular, Liquid Flow Based, NH3, and Seeder, share the same basic calibration steps, see (Figure 3-7). Each procedure has the option of performing a Static or In-Field calibration.

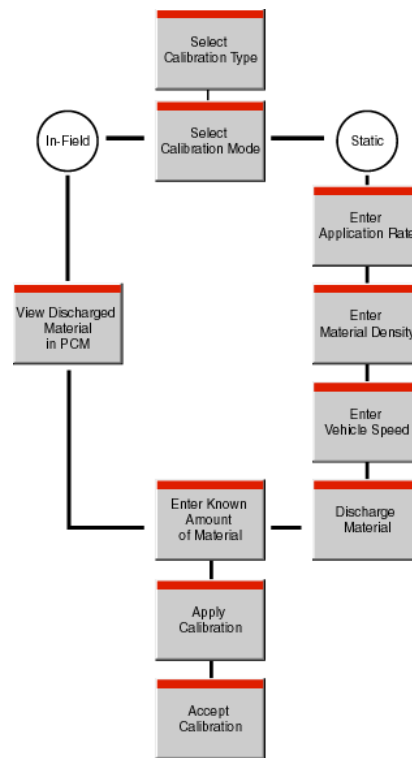
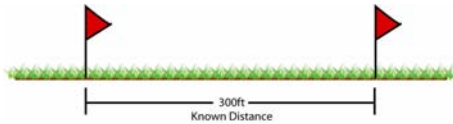

Figure 3-7: Typical Calibration Process

Distance/Speed Calibration

The Distance/Speed calibration process is used to calibrate a wheel speed sensor. When setting the system up for the first time perform the procedure below and for best results repeat this procedure until the reported distance and known distance match or are very close. To make a Quick adjustment to the Calibration number follow steps 2-4 and select Quick as the calibration mode.



1. Mark off a known distance of at least 300ft on a ground surface similar to your field application. Place a flag to mark your start and end point.

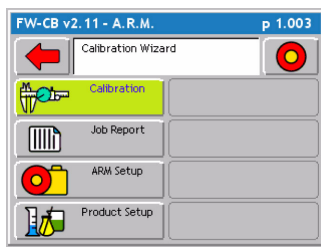

2. From the ARM Launcher page select the Calibration button by using the function key or by highlighting Calibration and pressing the green enter button.

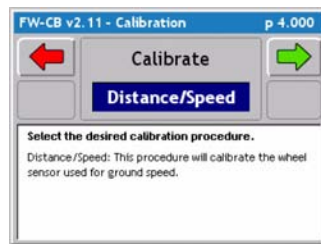

3. From the Calibration page select the Distance/Speed option from the pick list in the middle of the screen. Press the green forward arrow to continue to the next calibration step.

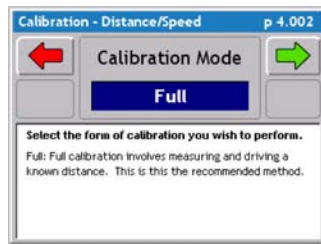

4. From the Distance/Speed page select Full from the pick list in the middle of the screen. Press the green forward arrow to continue to the next calibration step.

- **Full** - involves driving a known distance. Recommended for first time setup
- **Quick** - allows the operator to change the calibration number without driving. This is helpful if quick adjustments need to be made to an existing calibration number.

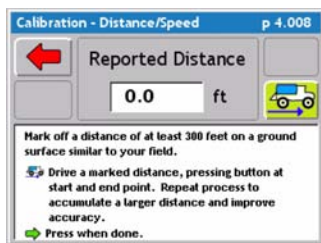

5. When driving the marked distance it is best to have the vehicle close to normal operating speed before reaching the start point. When the vehicle reaches the start point press the truck button. The truck button will begin to flash and feet will begin to accumulate.

Distance/Speed Calibration Continued

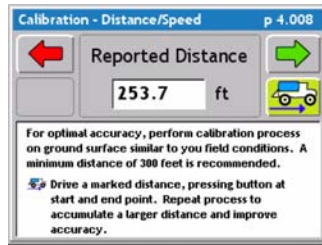

6. Maintain speed through the end point, when crossing the end press the Truck button to stop the distance accumulation. The distance displayed is the consoles reported distance. Press the green forward arrow key to continue to the next calibration step.

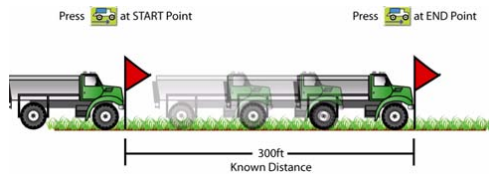

Be sure to hit the Truck button at the same location the vehicle crosses the Start and End Point. Example: If the Truck button is pressed when the front edge of the vehicle reaches the Start Point, then the Truck button must be presses When the front of the Vehicle reaches the End Point.

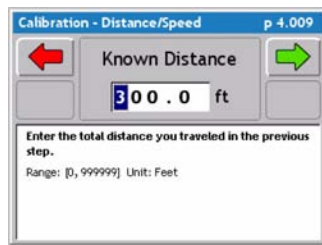

7. Enter the Known Distance. This is the path marked by the operator prior to calibration. Press the green forward arrow to continue to the next calibration step.

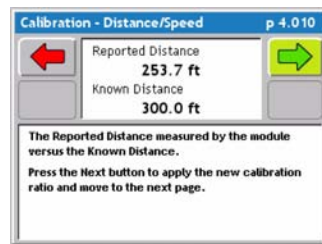

8. Reported Distance Vs. Known Distance. This page is only a information page to show the operator the Reported Vs. the Know. Press the green forward arrow to automatically recalculate the calibration number so the two distances match.

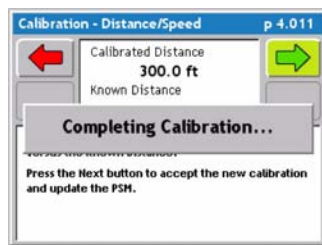

9. When the two distances match press the green forward arrow and the distance calibration procedure is complete.

Liquid Flow Static Calibration

The Liquid Flow Static Calibration process is a stationary calibration for a liquid flowmeter. There are two calibration modes to choose from, Static or InField, only one is needed for accurate calibration. Static calibrations does not involve movement of the vehicle and can be repeated very easily to ensure an accurate calibration.



1. Fill the machine's tank with a know amount of liquid or use the sight gage on the side of the tank to calculate a know volume. From the ARM Launcher page select the Calibration button by using the function key or by highlighting Calibration and pressing the green enter button.

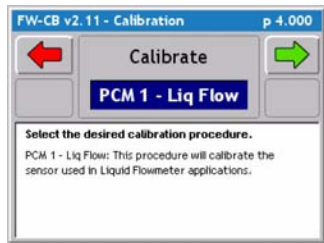

2. From the Calibration page select the PCM - Liq Flow option from the pick list in the middle of the screen. Press the green forward arrow to continue to the next calibration step.

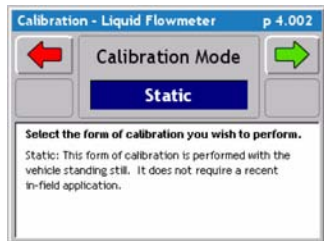

3. From the Calibration Mode page select Static from the pick list in the middle of the screen. Press the green forward arrow key to continue to the next calibration step.

- **Static** - Does not require the vehicle to move. This is a stationary test.

- **In Field** - Involves driving in a field, simulating a real time application.

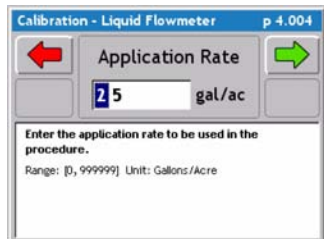

4. Enter the application rate that will be used later in a real time application for best results. Press the green forward arrow key to continue to the next calibration step.

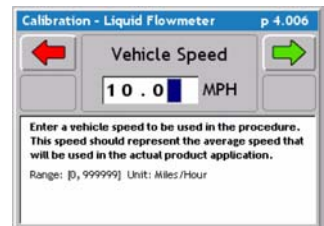

5. Enter the normal operating speed when applying. Press the green forward arrow to continue to the next calibration step.

Liquid Flow Static Calibration / Continued

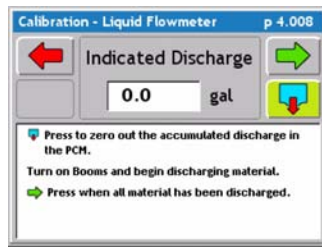

6. This is the indicated discharge, if there is any product accumulation prior to calibration it will show here. Press the empty tank button to zero the indicated discharge. Once zeroed, turn the product pump on and all boom product should begin to accumulate on the screen. The system should now be spraying at the speed and rate entered before.

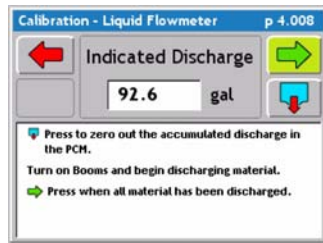

7. When a know amount has been discharged shut the booms off and accumulation will stop. Press the green forward arrow to continue to the next calibration step

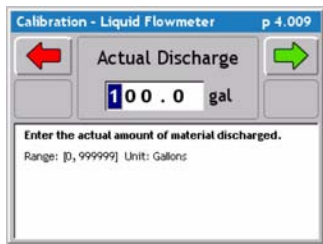

8. Enter the Actual amount discharged. This is the known amount put in the tank before calibration or know amount discharged by using the sight gage on the tank. Press the green forward arrow to continue to the next calibration step

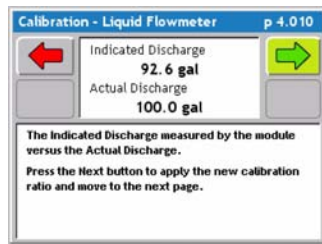

9. Indicated Discharge Vs. Actual Discharge. This page is only a information page to show the operator the Indicated Vs. the Actual. Press the green forward arrow to automatically recalculate the calibration number so the two volumes match.

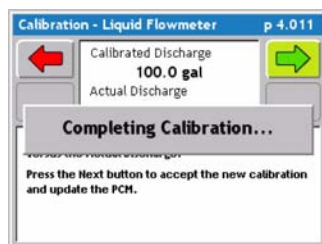

10. When the two volumes match press the green forward arrow and the Liquid Flow Calibration procedure is complete.

Liquid Flow In-Field Calibration

The Liquid Flow In-Field Calibration process is used to calibrate a liquid flowmeter after a real-time spray application. In-Field calibrations involves discharging a know amount of liquid in a real-time application and then performing a calibration based on the material discharged. Repeating the procedure below will ensure an accurate calibration.

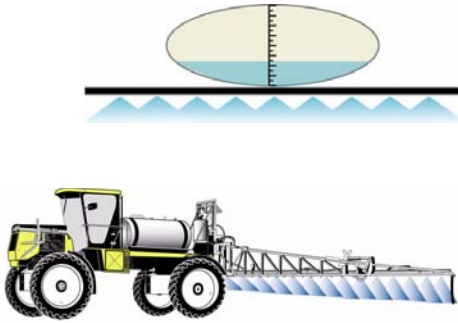

1. Load tank with a know amount of product. Record this amount for later use.

2. With the product loaded, apply the product. Make sure before starting the application all accumulated volumes are zero. This can be done by creating a new job when using a data card or if no data card is in use select field reset to set volumes to zero. The volume accumulated will be used in the In-Field Calibration procedure. For best results apply product at the rate and speed of normal operation.



3. Once the product has been applied, from the ARM Launcher page select the Calibration button by using the function key or by highlighting Calibration and pressing the green enter button.

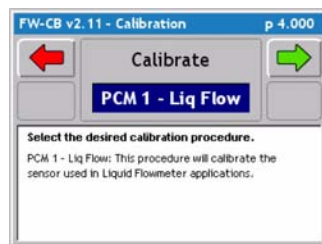

4. From the Calibration page select the PCM - Liq Flow option from the pick list in the middle of the screen. Press the green forward arrow to continue to the next calibration step.

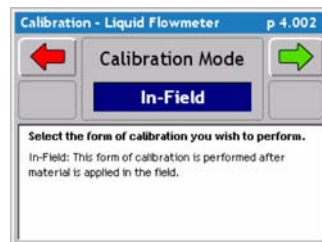

5. From the Calibration Mode page select In-Field from the pick list in the middle of the screen. Press the green forward arrow key to continue to the next calibration step.

- **In Field** - Involves driving in a field, simulating a real time application.

- **Static** - Does not require the vehicle to move. This is a stationary test.

Liquid Flow In-Field Calibration Continued

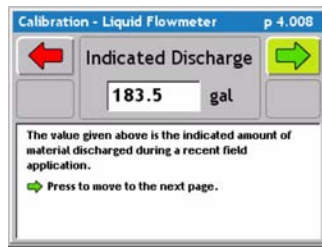

6. This is the indicated discharge. This value is obtained from the accumulated volume during the real-time application. This is why it is important to have the volume zeroed before application starts. Press the green forward arrow to continue to the next calibration step

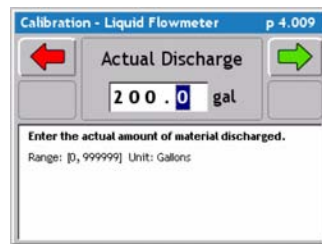

7. Enter the Actual amount discharged. This is the known amount put in the tank before application or know amount discharged by using the sight gage on the tank after application if the tank is not empty. Press the green forward arrow to continue to the next calibration step.

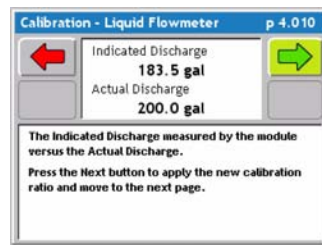

8. Indicated Discharge Vs. Actual Discharge. This page is only a information page to show the operator the Indicated Vs. the Actual. Press the green forward arrow to automatically recalculate the calibration number so the two volumes match.

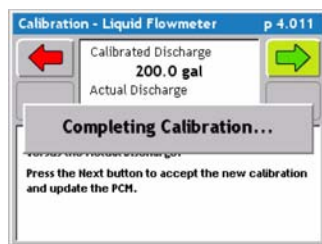

9. When the two volumes match press the green forward arrow and the Liquid Flow Calibration procedure is complete.

Granular & Seeder Static Calibration

The Granular Static Calibration process is a stationary calibration for a granular sensor. There are two calibration modes to choose from, Static or InField, only one is needed for accurate calibration. Static calibrations does not involve movement of the vehicle and can be repeated very easily to ensure an accurate calibration.

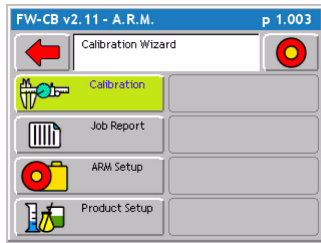

1. Fill the machine's tank with a know amount of weighed product. From the ARM Launcher page select the Calibration button by using the function key or by highlighting Calibration and pressing the green enter button.

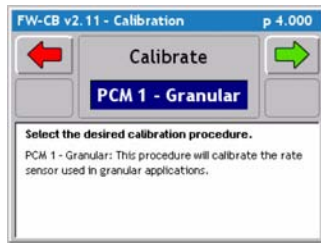

2. From the Calibration page select the PCM - Granular option from the pick list in the middle of the screen. Press the green forward arrow to continue to the next calibration step.

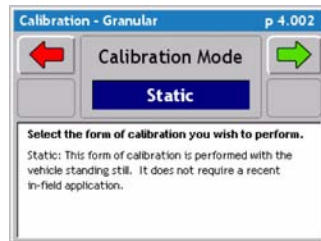

3. From the Calibration Mode page select Static from the pick list in the middle of the screen. Press the green forward arrow key to continue to the next calibration step.

- **Static** - Does not require the vehicle to move. This is a stationary test.
- **In Field** - Involves driving in a field, simulating a real time application.

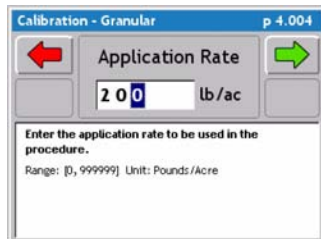

4. Enter the application rate that will be used later in a real time application for best results. Press the green forward arrow key to continue to the next calibration step.

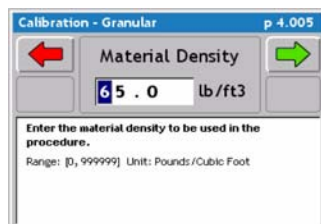

5. Enter the product density. Press the green forward arrow to continue to the next calibration step.

Granular & Seeder Static Calibration / Continued

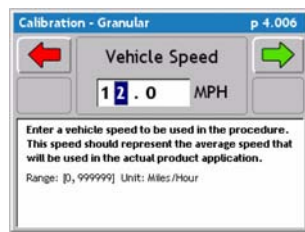

6. Enter the normal operating speed when applying. Press the green forward arrow to continue to the next calibration step.

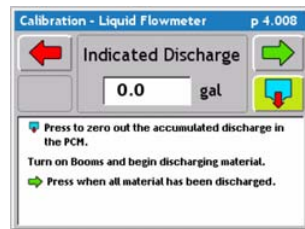

6. This is the indicated discharge, if there is any product accumulation prior to calibration it will show here. Press the empty tank button to zero the indicated discharge. Once zeroed, turn the product on. Product should begin to discharge and accumulate on the screen. The system should now be applying at the speed and rate entered

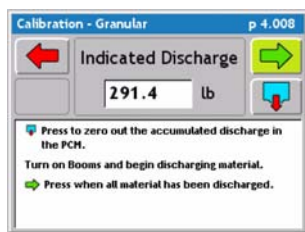

7. When a know amount has been discharged shut the product off and accumulation will stop. Press the green forward arrow to continue to the next calibration step

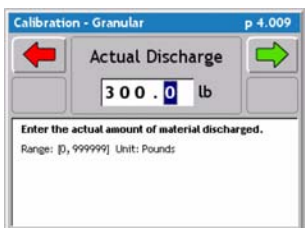

8. Enter the Actual amount discharged. This is the known amount loaded before calibration or know amount discharged by weighing the machine. Press the green forward arrow to continue to the next calibration step

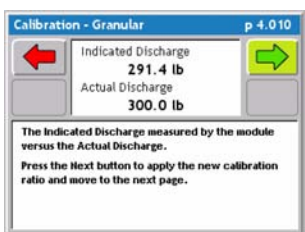

9. Indicated Discharge Vs. Actual Discharge. This page is only a information page to show the operator the Indicated Vs. the Actual. Press the green forward arrow to automatically recalculate the calibration number so the two volumes match.

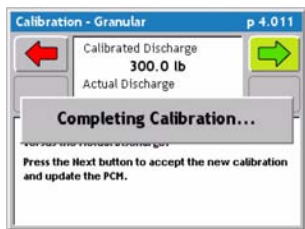

10. When the two weights match press the green forward arrow and the Liquid Flow Calibration procedure is complete.

Granular & Seeder In-Field Calibration

The Granular In-Field Calibration process is used to calibrate a Granular sensor after a real-time product application. In-Field calibration involves discharging a know amount of product in a real-time application and then performing a calibration based on the material discharged. Repeating the procedure below will ensure an accurate calibration.



1. Load machine with a know amount of product.
Record this amount for later use.

2. With the product loaded, apply the product. Make sure before starting all accumulated volumes are zero. This can be done by creating a new job when using a data card or if no data card is in use select field reset to set volumes to zero. The volume accumulated will be used in the In-Field Calibration procedure. For best results apply product at the rate and speed of normal operation.

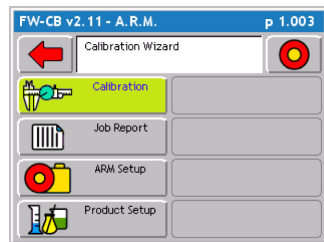

3. Once the product has been applied, from the ARM Launcher page select the Calibration button by using the function key or by highlighting Calibration and pressing the green enter button.

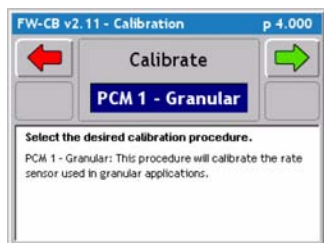

4. From the Calibration page select the PCM -Granular option from the pick list in the middle of the screen. Press the green forward arrow to continue to the next calibration step.

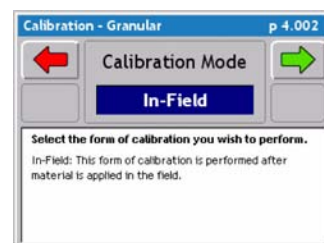

5. From the Calibration Mode page select In-Field from the pick list in the middle of the screen. Press the green forward arrow key to continue to the next calibration step.

- **In Field** - Involves driving in a field, simulating a real time application.

- **Static** - Does not require the vehicle to move. This is a stationary test.

Granular & Seeder In-Field Calibration Continued

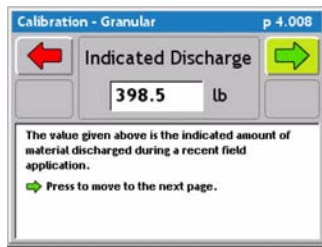

6. This is the indicated discharge. This value is obtained from the accumulated volume during the real-time application. This is why it is important to have the volume zeroed before application starts. Press the green forward arrow to continue to the next calibration step

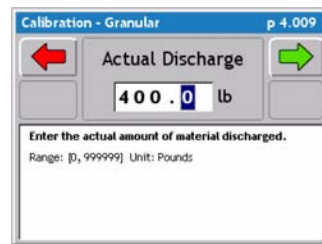

7. Enter the Actual amount discharged. This is the known amount put in the tank before application or know amount discharged by using the sight gage on the tank after application if the tank is not empty. Press the green forward arrow to continue to the next calibration step.

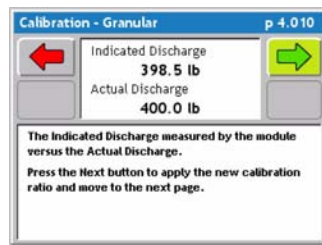

8. Indicated Discharge Vs. Actual Discharge. This page is only a information page to show the operator the Indicated Vs. the Actual. Press the green forward arrow to automatically recalculate the calibration number so the two volumes match.

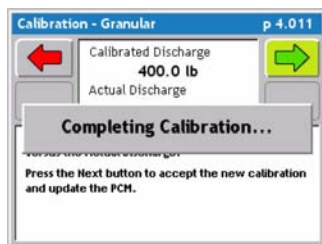

9. When the two volumes match press the green forward arrow and the Liquid Flow Calibration procedure is complete.

Pressure Calibration

The Pressure Calibration process is a stationary calibration for a pressure sensor. This procedure involves the discharge of material for the most accurate calibration. The use of water is recommended when calibrating. Repeating calibration procedure will ensure accurate calibration.



1. Fill machine with enough water to perform calibration and have a manual pressure gage mounted in-line with the booms. The most ideal location for a manual pressure gage is as close to the boom delivery point as possible. From the ARM Launcher page select the Calibration button by using the function key or by highlighting Calibration and pressing the green enter button.

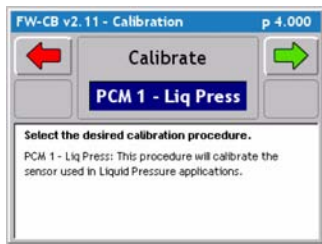

2. From the Calibration page select the PCM - Liq-Press option from the pick list in the middle of the screen. Press the green forward arrow to continue to the next calibration step.

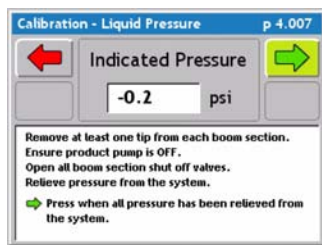

3. Indicated Pressure low is the current pressure reading on the system. This reading should be zero. With the product pump off open all boom valves and remove at least one to relieve pressure from the system. When pressure has been relieved press the green forward to set a zero value and to continue to the next calibration step.

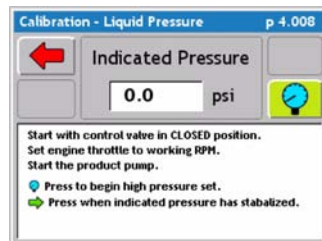

4. Indicated Pressure high (max operating pressure) is the high pressure reading at normal operation. Start with all booms on and the control valve closed. Set engine throttle to working RPM and start product pump. Press the blue pressure gage button to begin high pressure setting, the control valve will fully open and product will be discharging out the boom. When the pressure stabilizes, read and record the pressure from the manual gage, and press the green forward arrow to continue to the next calibration step.

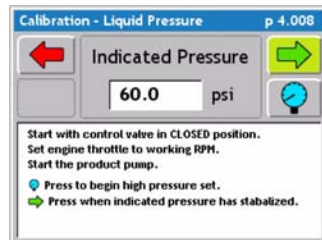

Pressure Calibration / Continued

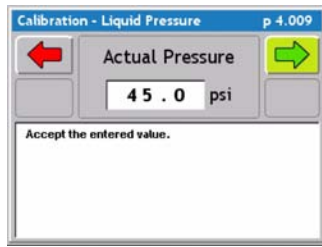

5. Enter the recorded pressure from the manual gage. Press the green forward arrow to continue to the next calibration step.

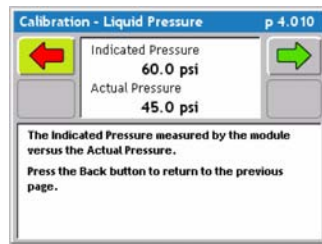

6. Indicated Pressure Vs. Actual Pressure. This page is only a information page to show the operator the Indicated Vs. the Actual. Press the green forward arrow to automatically recalculate the calibration number so the two volumes match

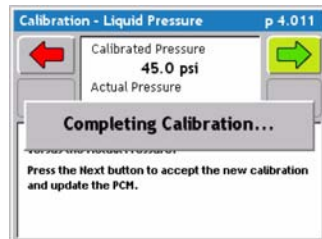

7. When the two pressures match press the green forward arrow and the Liquid Flow Calibration procedure is complete.

NH3 In-Field Calibration

There are two calibration procedures for NH3, Static and In-Field. **! CAUTION ! The Static calibration procedure is not recommended by Mid-Tech, do to the hazardous material being calibrated (Anhydrous ammonia, and Liquid nitrogen).** The recommended procedure is the NH3 In-Field Calibration process. This procedure is used to calibrate a NH3 flowmeter after a real-time product application. In-Field calibration involves discharging a know amount of product in a real-time application and then performing a calibration based on the material discharged. Repeating the procedure below will ensure an accurate calibration.



1. Load tank with a know amount of product or connect to an accurately weighed tank of anhydrous. Record this amount for later use.



2. With the product loaded, apply the product. Make sure before starting all accumulated volumes are zero. This can be done by creating a new job when using a data card or if no data card is in use select field reset to set volumes to zero. The volume accumulated will be used in the In-Field Calibration procedure. For best results apply product at the rate and speed of normal operation.



3. Once the product has been applied, from the ARM Launcher page select the Calibration button by using the function key or by highlighting Calibration and pressing the green enter button.

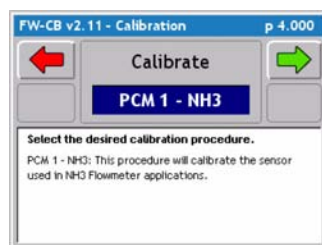

4. From the Calibration page select the PCM - NH3 option from the pick list in the middle of the screen. Press the green forward arrow to continue to the next calibration step.

NH3 In-Field Calibration Continued

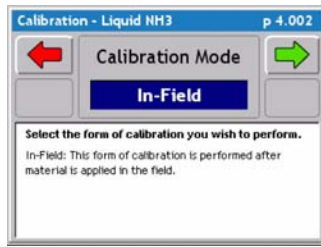

5. From the Calibration Mode page select In-Field from the pick list in the middle of the screen. Press the green forward arrow key to continue to the next calibration step.

- **In Field** - Involves driving in a field, simulating a real time application.
- **Static** - Does not require the vehicle to move. This is a stationary test.

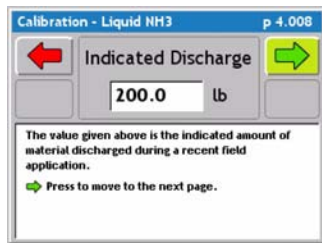

6. This is the indicated discharge. This value is obtained from the accumulated volume during the real-time application. This is why it is important to have the volume zeroed before application starts. Press the green forward arrow to continue to the next calibration step.

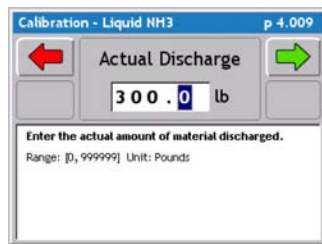

7. Enter the Actual amount discharged. This is the known amount put in the tank before application or know amount discharged by weighing the tank after application. Press the green forward arrow to continue to the next calibration step.

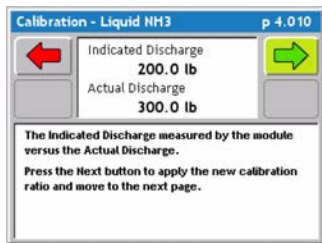

8. Indicated Discharge Vs. Actual Discharge. This page is only a information page to show the operator the Indicated Vs. the Actual. Press the green forward arrow to automatically recalculate the calibration number so the two volumes match.

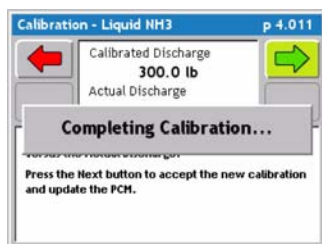

9. When the two volumes match press the green forward arrow and the NH3 Calibration procedure is complete.

Injection Static Calibration

The Injection Static Calibration process is a stationary calibration for a liquid injection pump. Static calibrations does not involve movement of the vehicle and can be easily repeated to ensure an accurate calibration. There are two calibration modes to choose from, Static or InField, The In-Field calibration procedure is not recommended by Mid-Tech.

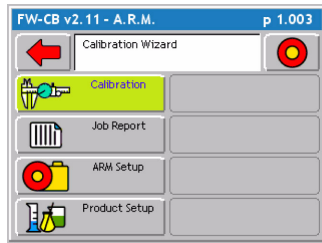

1. Fill the injection tank with product. From the ARM Launcher page select the Calibration button by using the function key or by highlighting Calibration and pressing the green enter button.

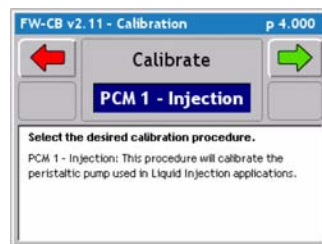

2. From the Calibration page select the PCM - Injection option from the pick list in the middle of the screen. Press the green forward arrow to continue to the next calibration step.

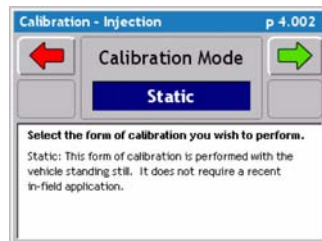

3. From the Calibration Mode page select Static from the pick list in the middle of the screen. Press the green forward arrow key to continue to the next calibration step.

- **Static** - Does not require the vehicle to move. This is a stationary test.

- **In Field** - Involves driving in a field, simulating a real time application.

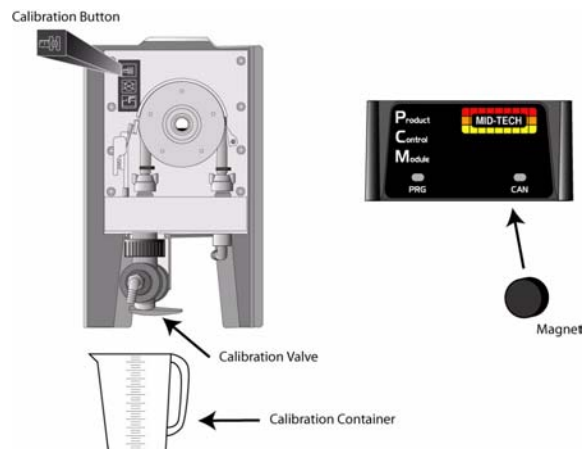

Injection Static Calibration / Continued

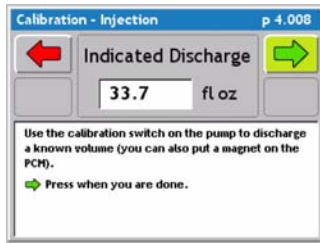

4. Place the calibration container under the calibration valve on the pump. Use the Calibration button on the pump or place a magnet on the PCM to start discharging product. As product discharges volume should accumulate on the Legacy. When a significant amount of material has been discharged let go of the calibration button or remove the magnet. Press the green forward arrow to advance to the next calibration step.

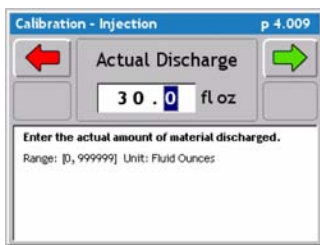

6. Enter the Actual amount Discharged. This is the known amount captured in the calibration container. Press the green forward arrow to continue to the next calibration step

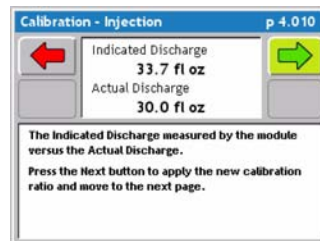

7. Indicated Discharge Vs. Actual Discharge. This page is only a information page to show the operator the Indicated Vs. the Actual. Press the green forward arrow to automatically recalculate the calibration number so the two volumes match.

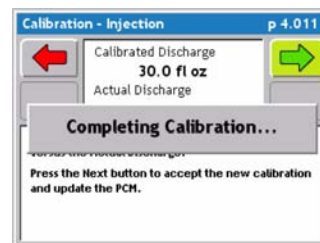

10. When the two volumes match press the green forward arrow and the Injection calibration procedure is complete.

Prime Injection System

Priming feature will only appear as an option if Injection has been selected as the Drive type during PCM setup. Priming is an Injection feature only. Priming the injection system can be done in three easy steps. Priming the system will take chemical from the injection storage tank directly to the injection point to ensure chemical is injected instantly upon the start of an application. **NOTE: Injection Calibration must be completed prior to priming for the system to properly prime.**

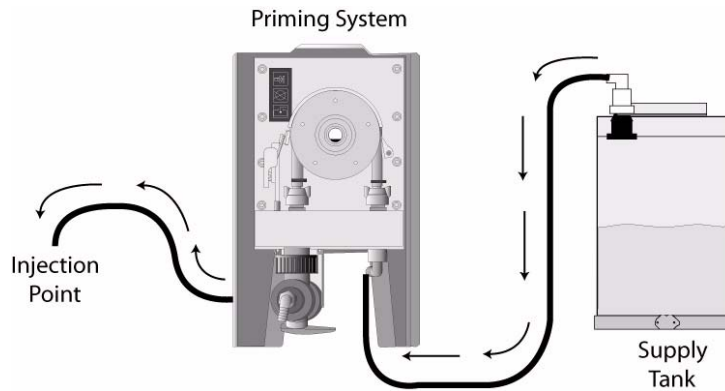

1. Calculate Prime value

Calculate the Prime value using the formula below, this value should be entered during PCM setup Drive Type Injection (See "Drive Type Settings" on page 2-25.)

Calculating the Prime Value

$$(\text{Line diameter}/2) \times 3.1416 \times \text{Line length} \times 0.5541 = \text{Volume in Fluid Ounces}$$

2. Setup System for Priming

Select the Prime button from the ARM launcher page, this will bring up the % Prime page. The prime page has two buttons (Prime State and Reset Values to Zero.) Prime State provides a detailed set of values of the priming process. During priming view this page to see the pump priming progress. The zero button will reset values to zero.

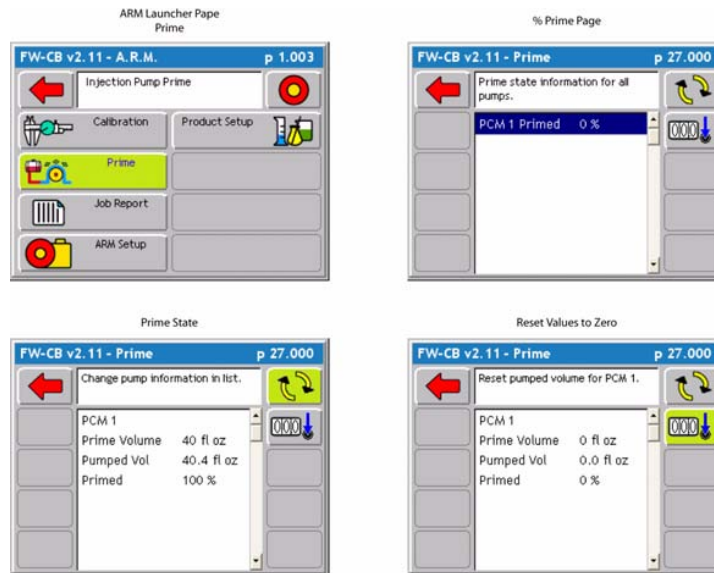

Figure 3-8: Setup System for Priming

3. Start Prime

From the prime page each pump is ready to prime. Press the prime button on the front of the pump (top button) or place a magnet on the front of the PCM to start the pump. The pump will stop automatically once the pump volume reaches the prime volume. To view the live prime process select the Prime State button. Repeat this procedure for each pump..

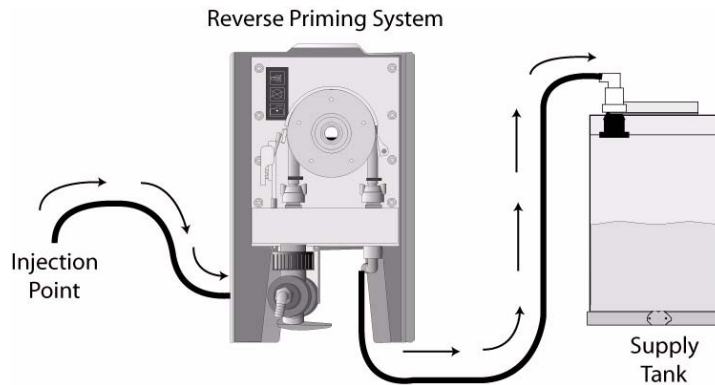

Figure 3-9: Prime and Prime State Button

Reverse Prime Injection System

Reverse Prime does not come standard on the peristaltic injection pump. Reverse Prime can be added as a feature. Call your local Mid-Tech distributor to order the reverse prime feature using Part# 54-02015.

Reverse prime works very similar to the priming procedure. Reverse Priming the system will take chemical from the injection point directly back to the storage tank to save as much chemical as possible. To Reverse Prime the system use the Prime button from the ARM Launcher page, this button will only appear as an option if Injection has been selected as the Drive type during PCM setup. Priming and Reverse Priming is an Injection feature only. Reverse Priming the injection system can be done in two steps if the system has been properly primed and a prime value has been calculated (See "1. Calculate Prime value" on page 3-25.)



1. Setup Stem for Reverse Priming

Select the Prime button from the ARM launcher page, this will bring up the % Prime page. The prime page has two buttons (Prime State and Reset Values to Zero.) Prime State provides a detailed set of values of the priming process. During priming view this page to see the pump priming progress. The zero button will reset values to zero.

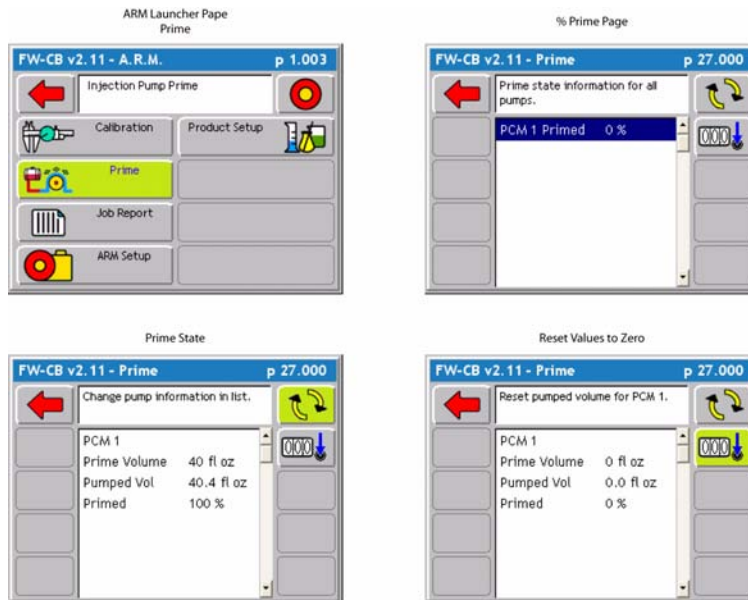

Figure 3-10: Setup System for Reverse Prime

2. Start Reverse Prime

From the prime page each pump is ready to reverse prime. Press the Reverse Prime button on the front of the pump (bottom button) and the pump should start turning. The pump will stop automatically once the pump volume reaches the prime volume. To view the live prime process select the Prime State button from the prime page.

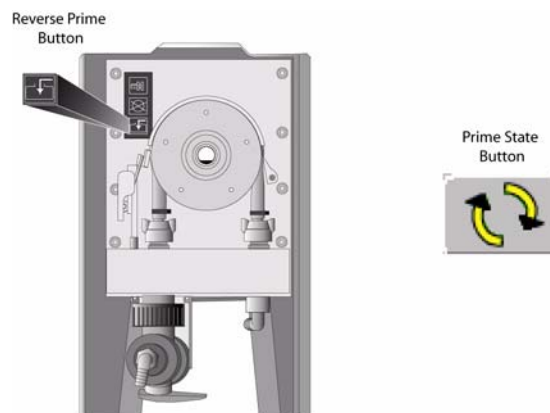

Figure 3-11: Reverse Prime & Prime State Button

Job Report Setup

A Job Report contains all the necessary information to build an application report after the job is completed. Application reports are generated in the Fieldware Map Manager desktop program.

Job Report is accessed from the ARM Launcher page (Figure 3-12). Select the Job Report tab and move to the Main Job Report Page (Figure 3-12). Table 3-3 describes each Job Report menu item.

No PCMCIA Card Selected

If you have the PC Card setting in Console setup set to NO, the Job Report tab will not be an option on the ARM Launcher page.

Running the Job Report Wizard

The Main job Report Setup page is the page seen when Job Report is first entered (Figure 3-12) right image. The Job Report page contains every setup item in a list. From this list each Job Report item can be edited individually or the Job Report Setup Wizard can be run. The top item in the list is the Setup Wizard. To run the Setup Wizard, highlight <Set Up Wizard> in the main list and press the enter key. The Setup Wizard will walk through the entire Job Report Setup item list.

It is not necessary to fill out any Job Report information in order to start applying products. The Job Report Information should be filled out if it is desired to write this data to the header of the record file (.RCD).

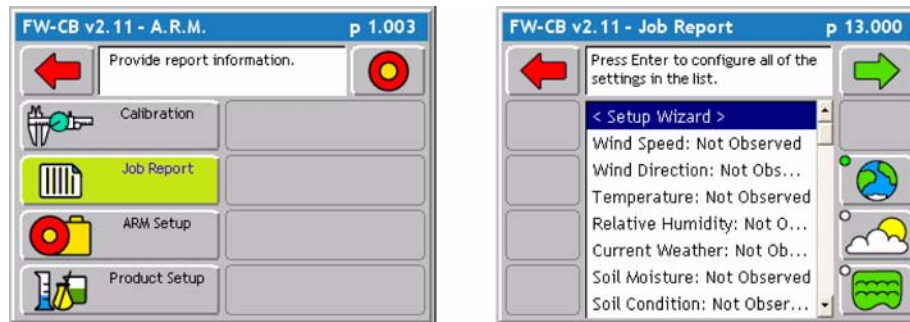

Figure 3-12: ARM Launcher / Job Report Page

Job Report Detailed Description

Item	Description
Wind Speed	Enter the observed Wind Speed. Units are based on the Units set in Console Setup. If no wind speed is to be entered, set this to NO.
Wind Direction	Enter the observed Wind Direction from the following directions NE, E, SE, S, SW, W, NW, N and Not Observed.
Temperature	Enter the observed Temperature. Units are based on the Units set in Console Setup. If no temperature is to be entered, set this to NO.
Current Weather	Select the appropriate weather condition from the following conditions: Sunny, Cloudy, Partly Cloudy, and Not Observed.
Soil Moisture	Select the appropriate Soil Moisture from the following conditions: Dry, Moist, Wet, and Not Observed.
Soil Texture	Select the appropriate Soil Texture from the following textures Fine, Medium Course, and Not Observed.
Soil Tillage	Select the appropriate Soil Tillage from the following conditions: No Till, Min Till, Conv Till, and Not Observed.
Soil Condition	Select the appropriate Soil condition from the following conditions: Good, Trashy, Smooth, Rough, and Not Observed.
Crop Name	Enter the name of the Crop.
Growth Stage	Select the appropriate Growth Stage from the following stages Pre-Plant, Pre-Emergence, Post Emergence, and Not Observed.

Table 3-3: Job Report Item Descriptions

ARM Setup

ARM Setup handles all data file names as well as a few product application parameters. To run ARM Setup, select the ARM Setup tab in the ARM Launcher page (Figure 3-13). This brings up the Main ARM Setup page (Figure 3-13) right image.

When ARM is first started, it asks the operator to enter/select a job name (see "Starting a Job" on page 2-4). This job name is used to automatically name all of the job related files.

No PCMCIA Card Selected

If you have the PC Card setting in Console setup set to NO, the ARM Setup main page looks slightly different. All ARM setup items related to files and naming files are omitted from the main page.

Running the ARM setup Wizard

The Main ARM Setup page is the page seen when ARM Setup is first entered (Figure 3-13) right image. The ARM Setup page contains every setup item in a list. From this list each ARM Setup item can be edited individually or the ARM Setup Wizard can be run. The top item in the list is the Setup Wizard. To run the Setup Wizard, highlight <Set Up Wizard> in the main list and press the enter key. The Setup Wizard will walk through the entire ARM Setup item list.

Table 3-4 lists all of the ARM Setup items and their descriptions.

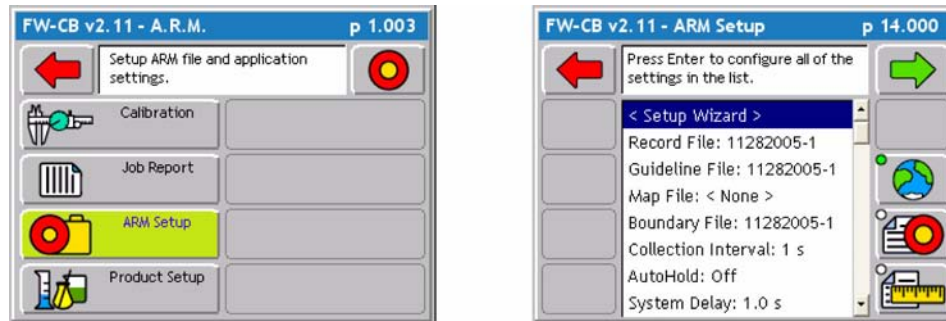

Figure 3-13: The ARM Launcher / ARM Setup Page

ARM Setup Detailed Description

Setup Item	Description
Record File (.RCD)	The spray trajectory data for a particular PCM/product application is stored in the Record file. The Record file contains rate, spray on and spray off data, and report data entered in the Job Report, as well as total boom width information. This file can be imported into the <i>Fieldware Map Manager</i> program where an application report can be generated. Maps of a (.RCD) file are known as “as applied” maps.
Guideline File (.GLN)	The Guideline file contains all information required to reconstruct the guidelines created and used during product application. This file can contain multiple guidelines in any orientation and can contain guidelines for any application task.
Map File (.GMF)	A Map file is used to store additional field features which might be necessary to locate during product application.
Boundary File (.BND)	The Boundary file can be used to show an existing field boundary or create a new field boundary. Mapping the filed boundary provides valuable area information.
Auto Hold	Auto Hold has three options: Boom Center of Full Swath, Boom End of Full Swath, and Section Center of each section (see "Auto Boom Shutoff (Section Center)" on page 2-33) . Each allows the controller to automatically turn spray activity off when the vehicle drives over a previously applied area. Center of Full Boom requires that the center of the boom be in an already applied area. Ends of Full Boom requires that the left end, right end and center of the boom be in an already applied area. Both options use the System Delay to compute the position of the boom.
System Delay	The System Delay is the number of seconds that the <i>ARM</i> program looks out in front of the vehicle. Based on the vehicles trajectory and this system delay value, the <i>Application Rate Management</i> program can determine where the vehicle is with respect to the prescription map. By looking out in front of the vehicle, the <i>ARM</i> program can identify the required rate for an upcoming prescription map region and notify the rate controller of any changes. This can help minimize lag times in the product delivery system when changing product rates. A value of two seconds is recommended.
GSO Speed	The Ground Speed Override (GSO) Speed is a desired minimum speed. When the vehicle speed drops below the GSO Speed, the GSO Speed is used. When the vehicle speed increases above the GSO Speed, then the vehicle speed is used.

Table 3-4: ARM Setup Item Description

Auto Boom Shutoff (Section Center)

Fieldware for the Legacy 6000 can automatically control up to ten sections. Auto boom shutoff works when the center of a section enters an applied area the controller will automatically turn that section off. Auto Boom Shutoff requires the addition of a SFM (Switch Function Module) that will tee directly into the CAN system (Figure 3-14).

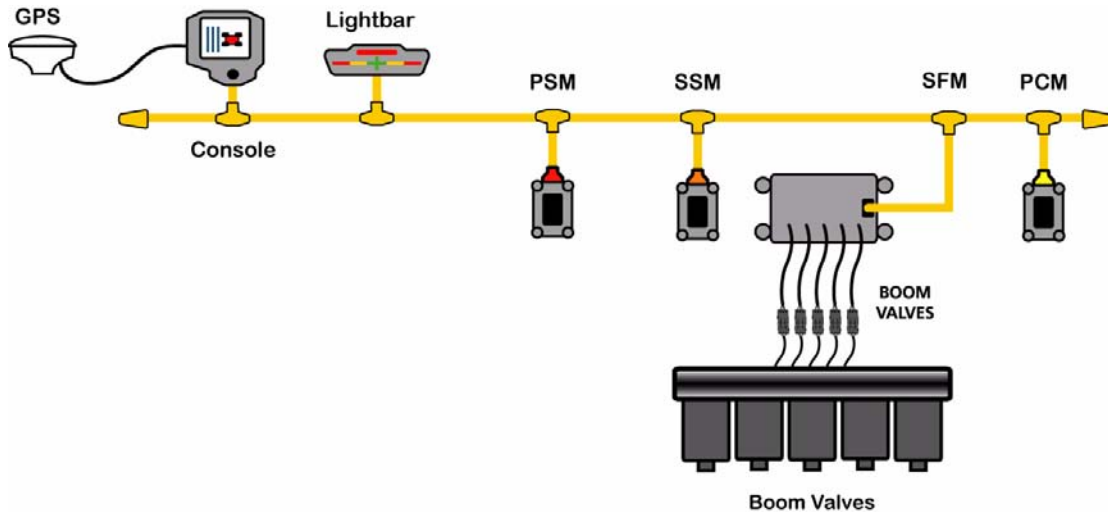

Figure 3-14: Switch Function Module and Auto Boom Example

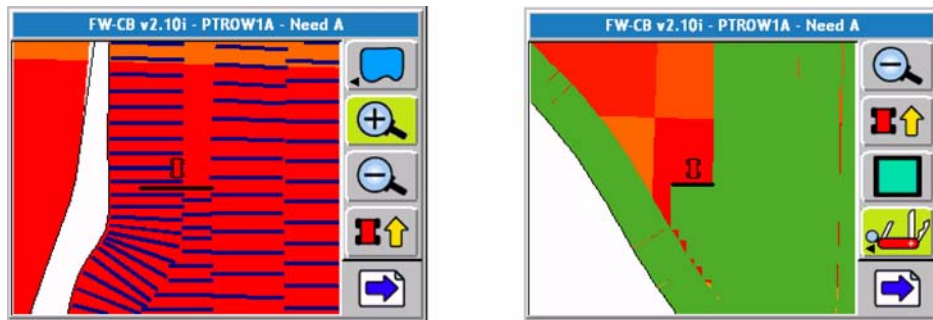

Figure 3-15: Auto Boom Shutoff Example

Enter a Record, Boundary, Guideline, or Map File Name

The file name defaults to the Job name (Figure 3-16) with file extension (.RCD,.BND,.GLN, or.GMF). If the job name is not used for this file name a new Record file name can be entered using the arrow keys on the Legacy 6000 console. To use an existing Record file, press the Folder button. The Folder button brings up a filename dialog from which an existing Record file can be selected (Figure 3-16). When the desired file has been selected, press the Forward Arrow to return to the Record File Wizard page. Press the Forward Arrow again to advance to the next wizard page.

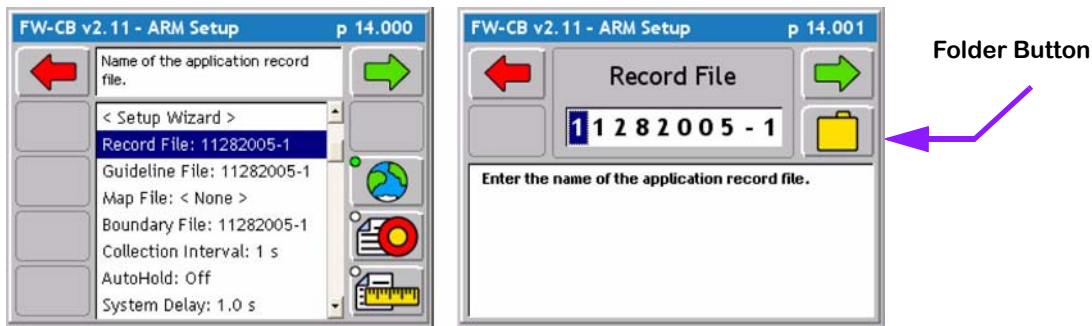

Figure 3-16: The ARM Setup Record File Page

Product Setup

Product setup is used to associate a product to a Product Control Module (PCM), as well as setup preset product application rates. To run Product Setup, select the Product Setup tab in the ARM Launcher page (Figure 3-17). This brings up the Select PCM page (Figure 3-18).

Running the Product Setup Wizard

When the PCM has been selected, the first page in Product Setup is the Main Product Setup page. The Main Product Setup page contains every setup item in a list. From this list each Product Setup item can be edited individually or the Product Setup Wizard can be run. The top item in the list is the Setup Wizard. To run the Setup Wizard, highlight <Set Up Wizard> in the main list and press the enter key. The Setup Wizard walks through the entire Product Setup item list.

Table 3-5 lists all of the Product Setup items and their descriptions.

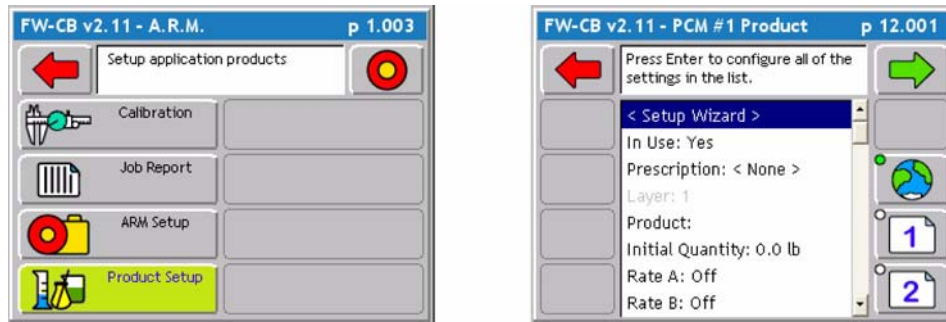

Figure 3-17: The ARM Launcher / Product Setup Page

Product Setup Detailed Description

Setup Item	Description
In Use	Defines whether the currently selected PCM is used in product application. Choose Yes or No.
Prescription	If doing Variable Rate product application, select the prescription file (.ARM) that contains the prescription information for that PCM. The (.ARM) file must be on the root of the PC card, and the PC card must be inserted into the Legacy 6000 console. If not doing variable rate, then leave this setting at <None>.
Layer	Some prescription files (.ARM) can contain several products in a single file. A single product is associated to a single PCM. In a multiple product prescription file it is necessary to set which product layer is associated with the currently selected PCM. If there is only one product layer in the (.ARM) file, this setup item is automatically set to layer 1 and this page is skipped in the Product Setup wizard process.
Product	Product Setup contains a product data base containing approximately 4000 product names and their associated EPA number. A product name can be selected from this setup page. If using a prescription map (.ARM), product setup automatically extracts the product name from the (.ARM) product layer. In the Product page select <From Map> setting.
Product Density	The density of the product being applied. For NH3 applications (See "Appendix C - NH3 Application" on page C-1.)
Calibration	If this is a new job the calibration number is retrieved from the PCM. You can change the calibration number here if desired. When starting ARM, this cal number is compared to the cal number in the PCM. If they are different you will be prompted to select which cal number to operate with.
Initial Quantity	The initial quantity in the tank/bin/hopper. The ARM software keeps track of the amount of product remaining and displays this in the Real-time Products page.
Rates A - E	The ARM software allows 5 preset application rates to be selected. These rates can be accessed in the Real-time page and over-ride the current rate.

Table 3-5: Product Setup Item Descriptions

The Select PCM Page

The Select PCM page (Figure 3-18) displays all PCMs that are setup and running when Product Setup is entered. Product setup must be run for each PCM to be used in the application process. If there is only one PCM connected this page will not appear and will advance directly to Product Setup parameters. Select the desired PCM to begin the Product Setup process for that PCM.



Figure 3-18: The Select PCM Page



If a PCM that is already setup is not going to be used in real-time product application, it is recommended that PCMs In Use setting is set to No.

Select the Product Name

If variable rate product application is being done, the product name can be extracted from the (.ARM) file (Figure 3-19). If variable rate product application is not being done, the name of the product being applied can be selected from the Fieldware Products Data base. The product name is written to the header portion of the (.RCD) file.

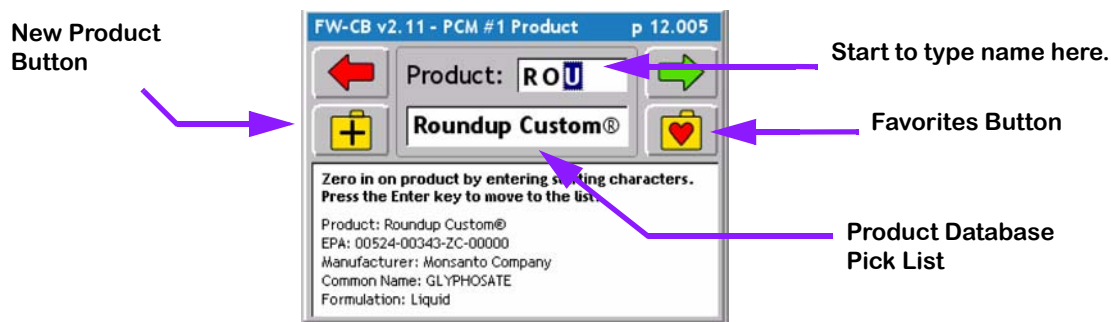

Figure 3-19: The Product Setup Select Product Page

Selecting a Product from the Products Database

To select a product from the products data base, start spelling the product name in the window next to Product. This is a fast method for selecting a product. As characters are typed in, the data base displays the closest entry to the character you type in. E.G. in (Figure 3-19) the first character entered was R, which jumped the database search to the area in the database where products start with the letter R. The next character entered was O. Now the database jumps to where products starting with RO are located. The next character entered was U, which jumped the database to the location where all products start with ROU. If applying Round-up, then arrow to the Product name dialog and, using the up and down arrow keys on the Legacy 6000 console, scroll through all of the different Roundup entries in the products data base. When the desired product name is selected, press the Forward Arrow to save and move to the next page.

Favorites

Product Setup keeps track of the product names commonly selected. The ten most common product names are saved in a Favorites list. Quickly select a product name from this Favorites list by pressing the Favorites button opens the favorites list. If the product name is in this list, select it here and continue running the Product Setup wizard.

New Product

If the product being applied is not in the Products data base, it can be added to the database by pressing the New Product button and following the short wizard to enter the new product information.

Variable Rate Application

When applying at variable rates a prescription map is needed. Prescription maps will contain product rate information and Product name. The file format that the Legacy accepts is a .ARM file. A shape file can be converted to a .ARM using Mid-Tech Fieldware Tools desktop software. Recent versions of prescription writing software can export a .ARM format.

The .ARM file must be placed on the root directory of the card. This means that the file can not be placed in a folder.

Selecting Prescription Map

The prescription map is loaded on the legacy by selecting Product Setup and then selecting Prescription and pressing enter. Use the Up and Down arrows to scroll through the pick list of prescriptions located in the center of the screen. Once the desired prescription is highlighted press the enter button or the green forward arrow to complete prescription selection.

Single Product Variable Rate Prescription Map

Select the desired prescription map in product setup press the green forward arrow and GO!.

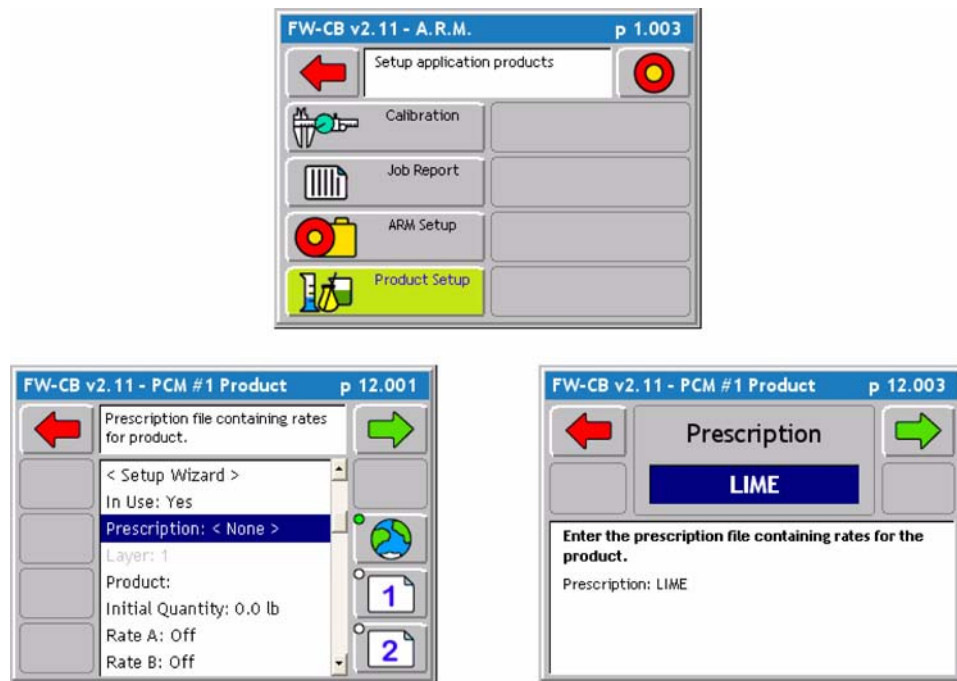

Figure 3-20: The Product Setup Prescription Map Page

Multiproduct Variable Rate

There are two ways of creating prescriptions to perform multiproduct variable rate applications. The first way is to create a separate prescription map for each product. The second way is to create one prescription map with all the products in one file.

Prescription Map for Each Product

Repeat the procedure below for each PCM and product prescription map.

1. From the ARM Launcher page select Product Setup.



2. Select the Desired PCM to be setup.



3. Locate and select Prescription in the center of the screen.

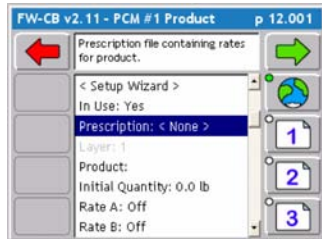

4. Select the desired prescription map by using the Up and Down arrows to scroll through the option highlighted in blue in the center of the screen. Note: None is the default setting and does not mean that there is no prescription maps loaded.

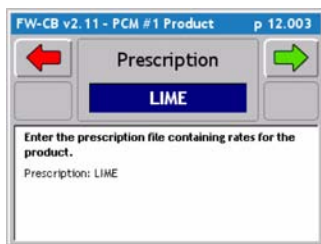

5. If Prescription file has a product name in the file it will automatically appear.

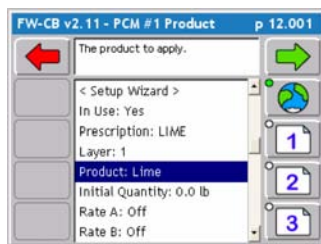

Fieldware for the Legacy 6000

Software Version 2.11

One Prescription Map for All Products

Repeat the procedure below for each product (PCM) and select the same prescription map for each PCM. Make sure to change the Layer to distinguish which product is assigned to each PCM.



1. From the ARM Launcher page select Product Setup.

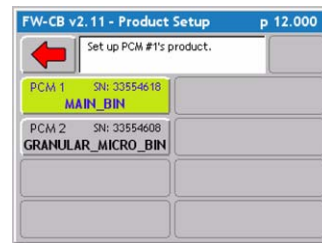

2. Select the Desired PCM to be setup.



3. Locate and select Prescription in the center of the screen.

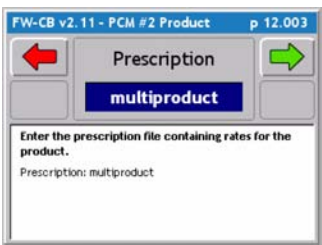

4. Select the desired prescription map by using the Up and Down arrows to scroll through the option highlighted in blue in the center of the screen. Note: None is the default setting and does not mean that there is no prescription maps loaded.



5. Locate and select layer from the center of the screen.

One Prescription Map for All Products Continued

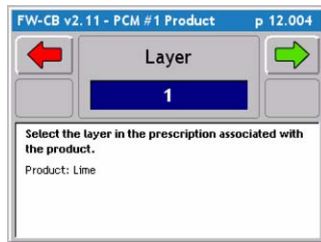

5. Select the layer that matches the product and PCM selected. Note: The operator must know which product is assigned to each layer in the map.

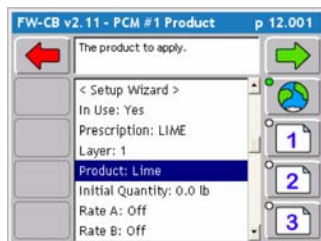

5. To help verify that the correct layer and product has been selected the product name should appear.

Select the Prescription Map Layer

If a multiproduct prescription file is not being done, it will not be necessary to set anything in this page. When using a Multiproduct Prescription file the operator must select different layers for each product being applied.

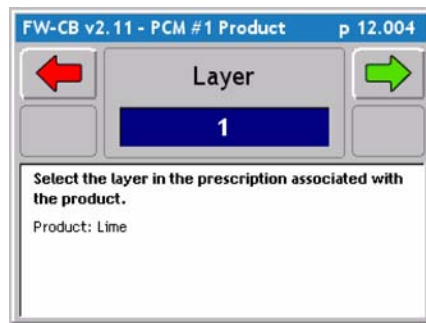

Figure 3-21: The Product Setup Layer Page

Chapter Notes

Chapter 4 - Real-time Operation

Operating Fieldware for the Legacy 6000.
Software Version 2.11



Product Application

When the Real-time Setup process is complete, (See “Chapter 3 - Real-time Setup” on page 3-1.), product application can begin. This is accomplished by pressing the ARM Bull’s-eye located in the ARM Main Launcher page (Figure 4-1).

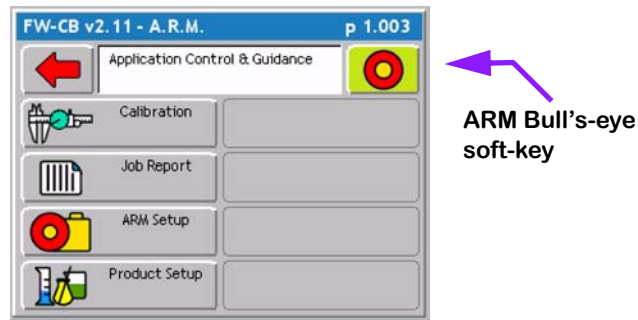

Figure 4-1: The ARM Launcher Page

When the ARM Bull’s-eye soft-key is pressed, the Fieldware ARM software loads the PCM and Implement setup information and Control parameters and data files. This loading process may take a few seconds to complete. When the loading process is complete, the Rates page (Figure 4-3) is the first real-time page seen.

Real-time pages

There are four real-time pages, three Information pages and one Map page. Each will be described in more detail.

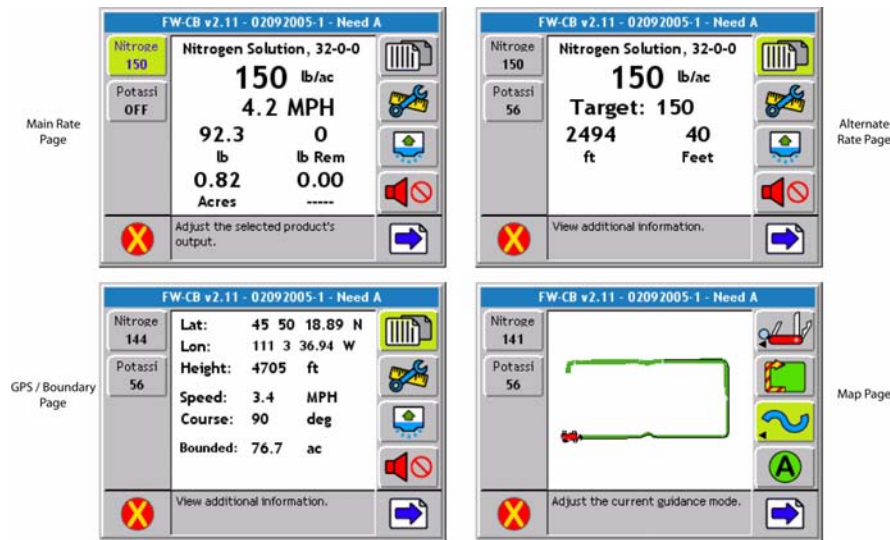

Figure 4-2: Real-time Pages

Information Pages

There are three information pages consisting of two Rate pages and a GPS / Boundary page.

Rate Pages

The Rate pages display various information related to the product and associated PCM. Highlighting a product control soft-key determines which rate information is displayed on the rates page. The Rates page displays the product name at the top of the page as well as the current rate, current speed, material applied, acres applied, and remaining amount of material and acres. A completed field boundary must exist to calculate the remaining acres. To view the remaining amount of product, the initial volume of material must be entered in Product Setup. For each product (PCM) there is also an alternative rates page (Figure 4-3) Right image. Information in this page varies based on the PCM configuration. This page typically displays the active swath width and additional sensor or monitor status information.

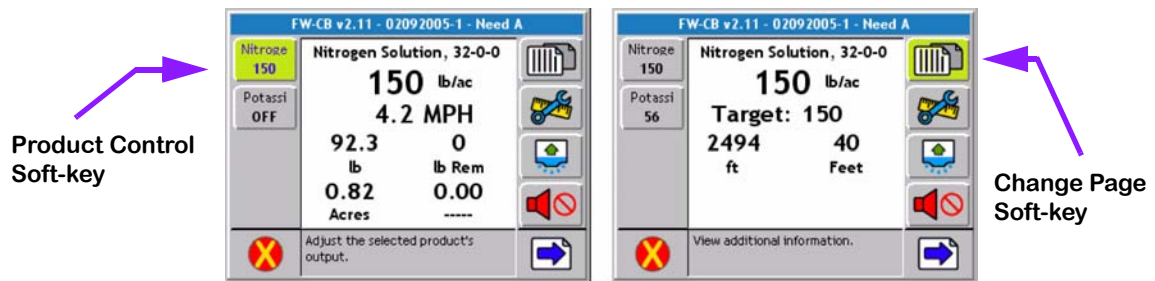

Figure 4-3: The Main Rate Page and Alternate Rate Page

GPS / Boundary Page

The GPS / Boundary page displays the current Latitude and longitude vehicle position, Antenna Height, GPS speed, Course in degrees (North 0°), Bounded acres.

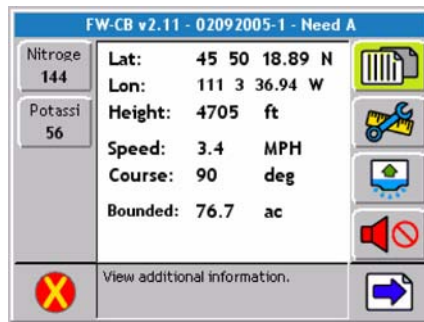

Figure 4-4: The GPS / Boundary Page

Adjusting the Product Application Rate

A product's rate can be adjusted while applying. To adjust a product rate, press the appropriate product control soft-key, which pops-up a side menu (Figure 4-5). This menu varies based on how the PCM is setup. Typically this side menu contains any preset rates defined in Product Setup, an On or Off setting, a Manual mode, and a VR mode if doing variable rate application. To adjust a rate, move up and down in the side menu using the up and down arrow keys on the Legacy 6000 console. When the desired rate is highlighted, press the enter key on the Legacy 6000 console. This will send the new rate command to the PCM.

To switch from the Rates page to the Map page, press the Change Page soft-key.

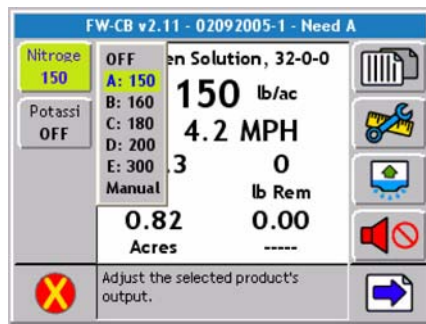

Figure 4-5: Adjusting a Product Rate

Manual Control

The control valve can be manually adjusted while applying or stationary for testing and trouble shooting purposes. To manually adjust a product rate, press the appropriate product control soft-key, which pops-up a side menu, the Manual rate option is selected in the side menu. When Manual mode has been selected, the current rate is displayed with a Black background. An increase rate and a decrease rate soft-key appears in the right side column. Press either of these soft-keys to adjust the rate. When using a Servo as the drive type to control product + should open the valve and - should close the valve.

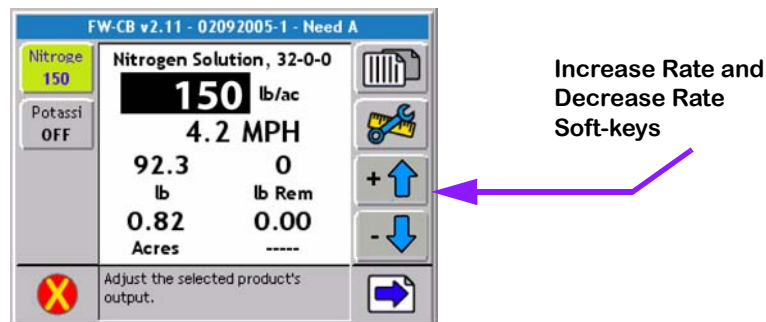

Figure 4-6: Manually Adjusting an Application Rate

Test Speed

To simulate a speed without moving the operator can use a function call Test Speed. Test Speed is accessed by pressing the System Devices button. Locate the PSM device and press the Test Speed button. Turn Test Speed on and enter the speed for simulation. NOTE: once setting are applied the system will start to operate at the entered test speed. If boom and pump are on the system will begin to apply. Apply the settings by pressing the green forward arrow. Press the red back arrow to return to the rate page and start using test speed. The rate page will show the speed highlighted black to indicate Test Speed is active.

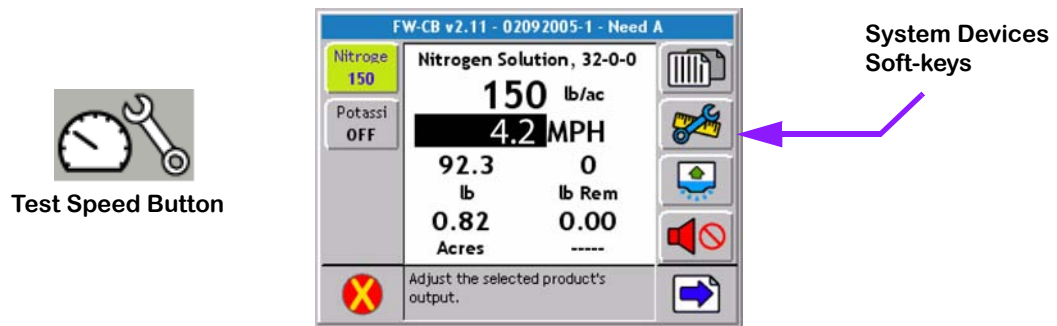

Figure 4-7: Manually Adjusting an Application Rate

Reset Initial Quantity

Initial quantity is a feature used to count down the product remaining to be applied. To rest this valve press the rest Initial Quantity button. Initial Quantity is set during Product Setup.

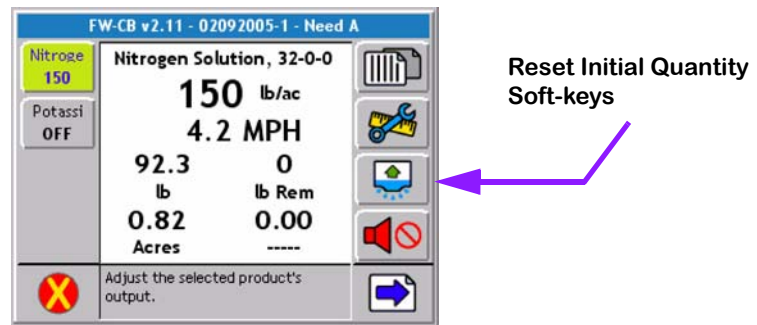









Figure 4-8: Manually Adjusting an Application Rate

Information Page Soft Keys Descriptions

Soft-key	Description
	<p>The Exit soft-key. When pressed Fieldware ARM exits out of the real-time process and returns to the Main Menu page.</p>
	<p>The Next Page soft-key. Pressing this soft-key switches between the map page and the rates page.</p>
	<p>The Alternate Rates Page soft-key. Press this to view additional product information, such as sensor and monitor status and current implement width.</p>
	<p>The Stop Alarm soft-key. Press this to mute an alarm.</p>
	<p>Manual Rate Increase soft-key. This soft-key is visible when the product control is set to Manual mode. Use this soft-key to manually increase the product application rate.</p>
	<p>Manual Rate Decrease soft-key. This soft-key is visible when the product control is set to Manual mode. Use this soft-key to manually decrease the product application rate.</p>
	<p>The CAN Process soft-key. When pressed this soft-key launches the CAN Process diagnostic. This is used Mainly to access Test Speed but can be used to trouble shoot the CAN modules when running in real-time.</p>
	<p>Re-fill soft-key. When this soft-key is visible and pressed the remaining volume is reset to the Initial Quantity entered in the Product Setup.</p>

The Map Page

To access the Map page from the information pages select the Next Page (Blue arrow on the bottom right of the screen). The Map pages allows the product application progress to be viewed. This page displays the vehicle at its current location, as well as current implement status. The application trajectory is also displayed. If doing variable rate application using a prescription map, the prescription map is seen in the background. The Map page is associated with the product control soft-key on the left side of the screen that is currently highlighted.

All guidance related soft-keys are displayed in the right side column of the map page. See Table 4-1 for a description of each soft-key that can be displayed in the Map page.

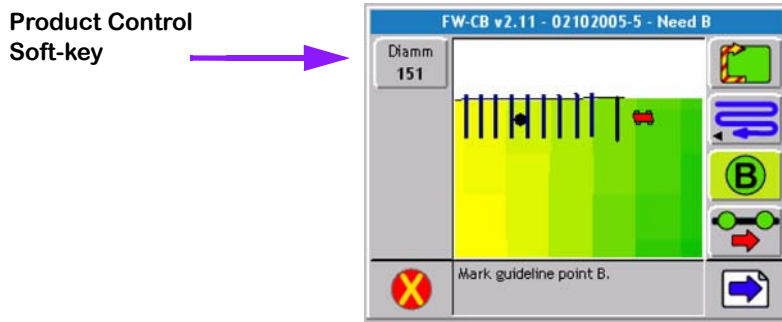

Figure 4-9: The Map Page

Solid Pattern and Boom Pattern

Area applied can be viewed as a solid painted area or as dropped bars representing the spray boom. The Solid pattern can assist in locating skip areas of application while the Boom pattern can show overlaps. To switch from one view to the next locate the Tools Button (swiss army knife) from the buttons on the right side of the screen. Selecting the knife will display a separate menu that allow the selection between Solid Pattern and Boom Pattern. Use the up and down arrows to make to highlight the desired selection and press the green enter button to accept the selection.

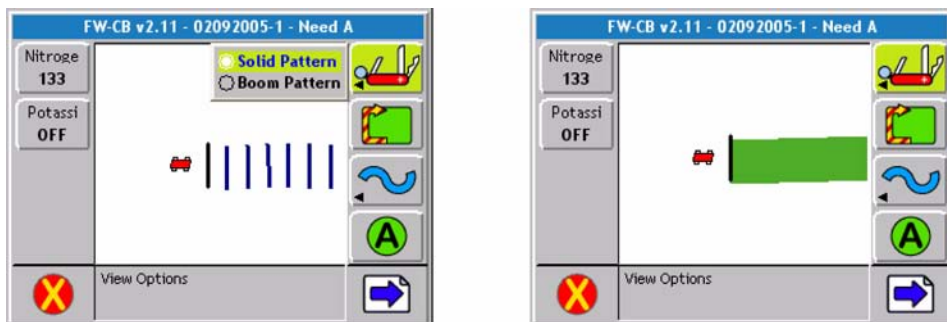

Figure 4-10: The Solid and Boom Pattern View

Real-time Map Page Soft-key Descriptions













Soft-key	Description
	The Exit soft-key. When pressed Fieldware ARM exits out of the real-time process and returns to the Main Menu page.
	The Next Page soft-key. Pressing this soft-key switches between the map page and the rates page.
	The Zoom In soft-key. When pressed decreases the area displayed in the view page. There are a total of 5 zoom levels.
	The Zoom Out soft-key. When pressed increases area displayed in view page. There are a total of 5 zoom levels.
	The Full Screen soft-key. When pressed, the entire map page space is replaced by the map view. This is useful when it is desired to see more of the vehicle trajectory. Press any key to return back to the normal view page.
	The Partial Screen soft-key. When the Full Screen Soft-key is pressed, the soft-key graphics change to the Partial Screen. When pressed the console display area contains the map view and the right-hand mapping button column.
	The North Up View soft-key. This map page display option, keeps North pointing to the top of the view page. When pressed this soft-key changes to the COG View soft-key.
	The Course on Ground (COG) View soft-key. This view page option, keeps the vehicle stationary in the view page with the heading (course) of the vehicle pointing to the top of the view page. When pressed this soft-key changes to the North Up View soft-key.
	The Center Vehicle soft-key. Press this to center the vehicle in the map page.
	The Mark A soft-key is used with the Parallel pattern. This soft-key is pressed to mark the first end point of the initial guideline. When pressed, this soft-key changes to the Mark B soft-key.
	The Mark A soft-key is used with the Parallel pattern. This soft-key is pressed to mark the first end point of the initial guideline. When pressed, this soft-key changes to the Mark B soft-key.
	The Mark B soft-key is used with the Parallel and Headland patterns. This soft-key is pressed to mark the end point of the initial guideline. When pressed, this soft-key changes to the New Guideline soft-key.

Table 4-1: Real time Soft-key Description











Soft-key	Description
	The New GuideLine soft-key. This soft-key appears after the initial guideline has been created. When pressed, this soft-key changes to the Mark A soft-key and guidance is disabled until a new guideline is created by pressing Mark A and then Mark B.
	The Switch Guideline soft-key. This soft-key appears when more than one guideline has been created.
	Straight-line Parallel Guidance soft-key. This soft-key indicates the current guidance pattern is straight-line parallel guidance. The initial guideline is defined by marking end points A and B. Pressing this soft-key pops-up a side menu to allow the selection of a different guidance mode, such as Headland or Circle Pivot.
	Curved-line Guidance soft-key. This soft-key indicates that the current guidance pattern is Curved guidance. Pressing this soft-key pops-up a side menu to allow the selection of a different guidance mode, such as Straight-line or Circle Pivot.
	The Ignore Headland Guidance pattern soft-key. When pressed, headland data identified using the Headland On and Headland Off soft-keys, are excluded from vehicle guidance. See (The Ignore Headland Guidance Pattern on page 5-19).
	The Headland On soft-key. When pressed any applied data collected will be considered part of the field headland. See (Step 1: Start Applying Headlands on page 5-20).
	The Headland Off soft-key. When pressed any applied data collected will not be considered part of the field headlands. See (Headland Pattern Example on page 5-16).
	Circle Pivot Guidance soft-key. This soft-key indicates the current guidance pattern is Circle Pivot parallel guidance. The initial guideline is defined by marking points A and B along a circle. Pressing this soft-key pops-up a side menu to allow the selection of a different guidance mode, such as Headland or Straight-line.
	The Circle Mark A soft-key is used with the Circle Pivot pattern. This soft-key is pressed to mark the first end point of the initial circle guideline. When pressed this soft-key changes to the Circle Mark B soft-key.
	The Circle Mark B soft-key is used with the Circle Pivot pattern. This soft-key is pressed to mark the end point of the initial circle guideline. When pressed this soft-key changes to the New Circle Guideline soft-key.
	The Circle Mark B Wait soft-key. This soft-key appears when the Circle Mark A has been pressed and the software is collecting enough points (approximately 12 seconds) to describe a circle. After approximately 12 seconds has passed, this soft-key is replaced by the Circle Mark B soft-key.

Table 4-1: Real time Soft-key Description





Soft-key	Description
	<p>The Switch Circle Guideline soft-key. This button appears when the guidance mode is circle pivot and there is more than one circle guideline created. Pressing this allows the selection of a different existing circle guideline.</p>
	<p>The Map Field Boundary Off soft-key. When this soft-key is displayed, the field boundary is not being mapped. When pressed this soft-key changes to the Map Field Boundary On soft-key.</p>
	<p>The Map Field Boundary On soft-key. When this soft-key is displayed, the field boundary is being mapped and stored to file. When pressed this soft-key changes to the Map Field Boundary Off soft-key.</p>
	<p>The Point soft-key. This is the point map object. When pressed a point is placed at the vehicle location.</p>
	<p>The Hazard soft-key. This is the hazard map object. When pressed a hazard is placed at the vehicle location.</p>

Table 4-1: Real time Soft-key Description

System, Warning and Error Messages

Fieldware for the Legacy 6000 provides system operation feedback in the form of System messages, Warnings, and Error Messages. This system information is displayed in the top portion (banner bar) of the rates page and map page. Some messages are displayed on the lightbar, see (Lightbar Index on page 5-35) for more information about these messages.

System Message

A system message does not obstruct real-time operation. The most common system message is the System Ready, (Figure 4-10), message that occurs when the Legacy 6000 system is operating properly.

Warning Message

A warning message does not obstruct real-time operation. When a warning message first appears in the banner bar, the alarm sounds. The alarm can be muted by pressing the Alarm Mute soft-key. The warning message remains in the banner bar until the situation causing the warning is resolved. The alarm does not sound again until a new warning appears. Typical warning messages relate to product application rates and speeds.

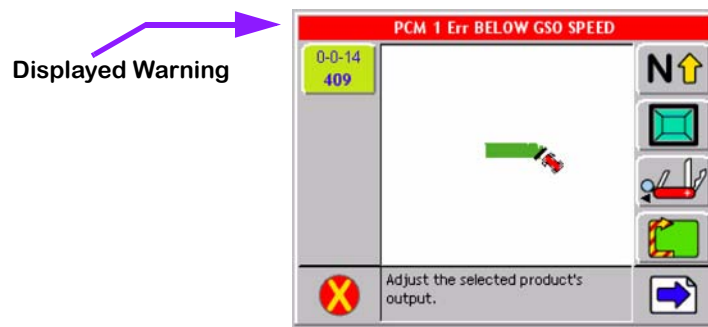

Figure 4-11: GSO Speed Warning Message

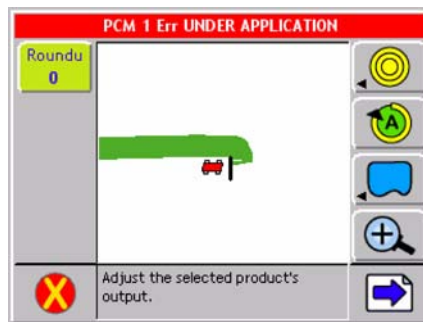

Figure 4-12: Under Application Warning Message

Error Message

An error message stops real-time operation until the problem is resolved. The alarm sounds, a dialog is presented to the user (Figure 4-13), and the user must respond to the dialog. The response to the dialog is typically an acknowledgement of the error. The error message in Figure 4-13 is a result of a sensor on PCM #1 being disconnected. The operator is asked to acknowledge this error by pressing the enter key. If the error is resolved prior to the acknowledgement, an error correct dialog will replace the error message dialog, (Figure 4-14).

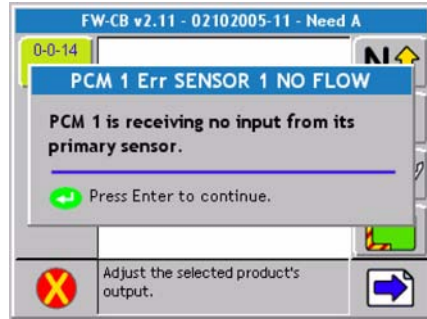

Figure 4-13: Sensor No Flow Error Message Dialog

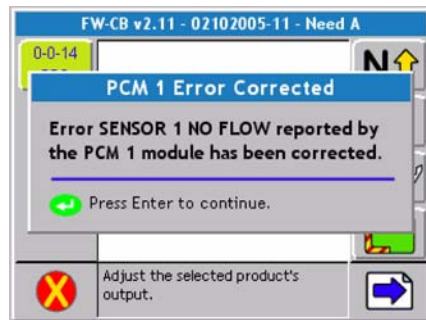

Figure 4-14: Error Corrected Message

Real-time Guidance Operation



This portion of the user's guide assumes you have activated the Fieldware Manual Guidance plugin, see Chapter 2 of this user's guide.

Fieldware-SA for the legacy 6000 allows you to perform product application and vehicle guidance simultaneously. To run guidance while applying a product, the Lightbar setting must be set to Text/Lights (Lightbar Setup on page 5-9).

At this point a DGPS receiver should be connected to the Legacy 6000 console and running properly. It is always a good idea to verify that the DGPS receiver is running properly and communicating with the console prior to driving out to the field. To verify that the receiver is working properly, run the system diagnostic tool Receiver Process, (GPS Receiver on page 5-4).

If an external rate controller is being used, that controller should be connected to the appropriate COM port on the console and running properly.

Starting Guidance

When product application is started by pressing the ARM Bull's-eye, guidance automatically starts. The initial guidance pattern is set to the Straight-Line mode. It is possible to switch between any of the three guidance modes while in real-time operation (Figure 4-15). The four guidance patterns to choose from are Straight-Line, Headland, Ignore Headland, and Circle-Pivot. Each is described in more detail below.

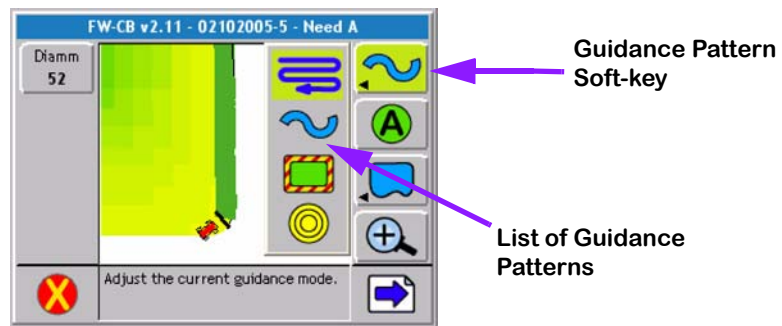

Figure 4-15: Selecting a Guidance Pattern in Real-time

Changing Guidance Pattern

To change from one guidance pattern to another, press the Guidance Pattern soft-key (Figure 4-15). This soft-key displays the current pattern selection on the key itself. Pressing this soft-key pops-up a sub-menu. This side menu displays the available guidance patterns. To select a pattern high-light, the desired pattern using the Up and Down Arrow keys. When high-lighted, press the Enter key. This switches to the new guidance pattern.

The Straight-Line Guidance Pattern

This section describes how to run the Straight-Line Guidance pattern. This pattern provides guidance along straight lines based off of an initial A-B reference line. This is the default guidance pattern when real-time operation is first started. The first step is to establish the initial A-B guideline. This initial baseline is used to calculate all other parallel guidelines.

Mark Point A

To mark the initial point A, begin driving along the first swath path. Typically this would be along a straight edge of a field boundary. While the vehicle is driving along the initial swath, the lightbar in displays the MARK A message. This message appears until the guideline point A is established. To establish the guideline point A, press the Mark A soft-key. When pressed, the Mark A soft-key in the button column automatically changes to the Mark B button soft-key and the lightbar displays the MARK B message.

Mark Point B

The next step is to establish guideline point B. To establish guideline point B, press the Mark B soft-key in the button column. The B point is displayed in the map page. This establishes the initial swath baseline. When the baseline is established (Figure 4-16), the lightbar begins displaying the user defined messages that were selected in the setup process.

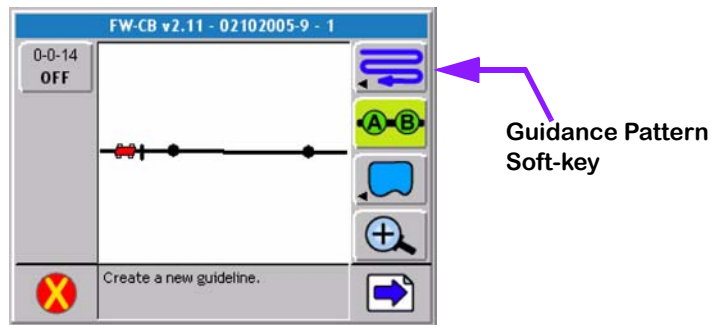

Figure 4-16: Establishing the Initial A-B Line

A new A-B line can be created by pressing the New A-B soft-key and repeating the Mark A Mark B process described above.

The Headland Guidance Pattern

This section describes how to operate the Headland guidance pattern. The Headland pattern is selected when the operator wants to drive several circuits around the field boundary and be guided around all circuits that occur after the first circuit. When several headland circuits have been completed, the operator then has the choice of switching back to the Straight-Line pattern. The Headland pattern is also selected when a user wants to do product application on terraced fields. In the Headland curved guidance pattern, the operator can pull along side any previous applied swath and be guided parallel to that swath.

Applying Multiple Headland Circuits

Figure 4-17 shows the Map page when the Headland pattern is selected. While operating in the Headland pattern, the user has the option to mark the A and B points for the Straight-Line pattern. This feature makes it easier for the operator to Mark the A and B points while in curved mode applying the headlands. It is always best to mark the A and B points for the Straight-Line pattern while driving along a straight edge of a field.

The operator will remain in the Headland pattern until the pattern is changed using the Guidance Pattern soft-key, see (Changing Guidance Pattern on page 5-13). The A and B points are only required for the Straight-Line pattern. The Headland pattern does not require an A-B line.

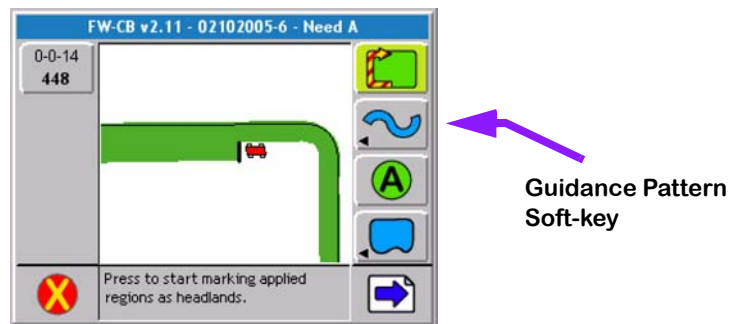

Figure 4-17: Operating in Headland Pattern

Headland Pattern Example

In this example the operator wants to apply two headland passes to the field and then switch to Straight-Line mode and apply the remainder of the field with straight-line parallel swath guidance. After the first headland circuit the operator pulls parallel to the first circuit swath and begins applying the second circuit while being guided parallel to the first circuit.

Figure 4-18 shows the operator just finishing the first headland circuit. When the operator pulls along side the first headland circuit, curved guidance automatically starts. The operator is now able to drive the second headland circuit parallel to the first circuit by following the guidance information displayed on the lightbar.

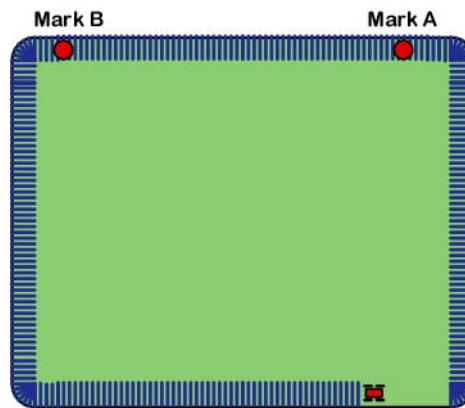

Figure 4-18: Completing the First Headland Circuit

Figure 4-19 shows the operator being guided along side the initial headland circuit. The lightbar automatically supplies guidance information. For more details on how to interpret curved guidance information on the lightbar see (Lightbar Curved Guidance Graphics on page 5-27).

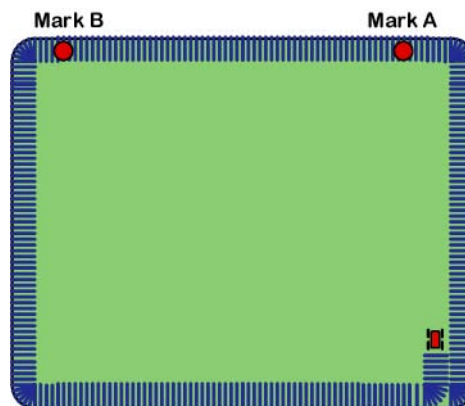

Figure 4-19: Starting the Second Headland Pass

Figure 4-20 shows the operator continuing to drive around the second headland circuit.

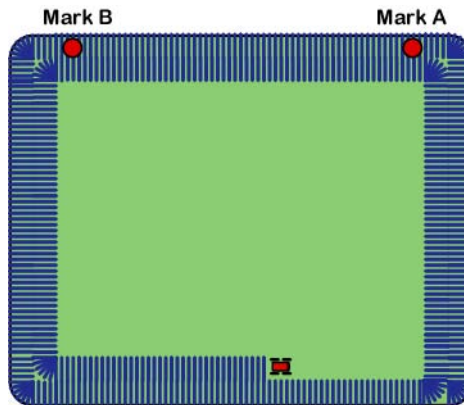

Figure 4-20: Continuing Around the Second Circuit.

Switching from Headland to Straight-line A-B Pattern

When the operator has completed the desired number of headland circuits, two circuits in our current example, guidance can be switched to the Straight-Line Pattern to apply the remainder of the field in that pattern.

To switch from the Headland pattern to another pattern see (Changing Guidance Pattern on page 5-13). If the operator is being guided along a curved path when the pattern is switched, the lightbar will no longer guide them along the curved path.

If the A and B points were marked while in the Headland Pattern, the software automatically guides the vehicle along the closest parallel line, as soon as the operator switches to the Straight-Line Pattern. If no A B points were marked during the curved guidance process, the operator needs to mark the A B points. The lightbar displays the MARK A message, indicating that no initial A B line exists.

Figure 4-21 shows the operator applying product in the Parallel pattern. Because the initial A B line was established during the curved guidance process, the user can immediately start straight-line guidance by pressing the guidance mode button

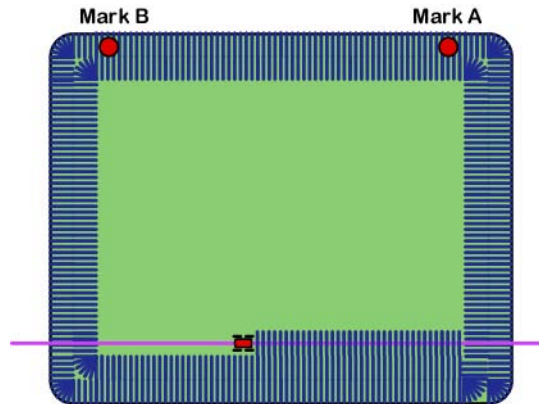

Figure 4-21: Switched from Headland Pattern to Straight-Line Pattern.

Figure 4-22 shows the completed field. Notice that there are several areas of the field where the operator turned the spray off to avoid double application on previously applied areas.

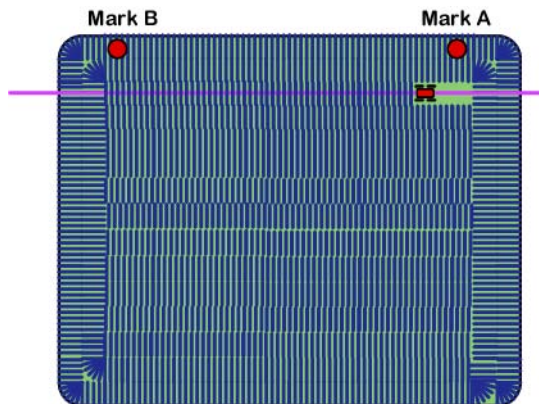

Figure 4-22: Completed Field Application

The Ignore Headland Guidance Pattern

The Ignore Headland Guidance pattern allows you to apply the headlands and then ignore that data when applying in the interior of the field. Using this option will improve your ability to be guided to the start of the next pass, right side of Figure 23. If you do not use the ignore headlands option you may find that your lightbar attempts to guide you along a headland pass as you drive through the headlands to get to the next interior pass, left side of Figure 23. Table 4-2 is a quick guide on how to run north Ignore Headland pattern. A more detailed description can be found further on in this chapter.



Figure 4-23: Crossing through Headlands





Soft-key	Description
	Select a guidance pattern, typically the Headland pattern.
	Press the Headland On softkey and begin applying headlands. Make as many headland passes as you like. You can boundary map and Mark A and B points while applying the first pass.
	When the last headland pass is completed press the Headland Off softkey. Next apply the first interior pass using the headland trajectory for guidance.
	Once the first interior pass is completed, switch from your current guidance pattern to the Ignore Headland pattern. Continue to apply the remained of the field.

Table 4-2: Ignore Headland Pattern Quick Step

Ignore Headland Pattern Example

Step 1: Start Applying Headlands

From the Map page during real-time operation, make sure you are in Headland guidance mode. Press the Headland On button and begin applying the first headland pass. During the first pass you can be mapping out the field boundary, see (Mapping a Field Boundary on page 5-30). Apply as many headland passes as you like. You can also mark the A and B points for Straight-Line guidance, see (The Straight-Line Guidance Pattern on page 5-14). Figure 24 shows the vehicle applying the first headland pass. The Headland On button is shown to the left.

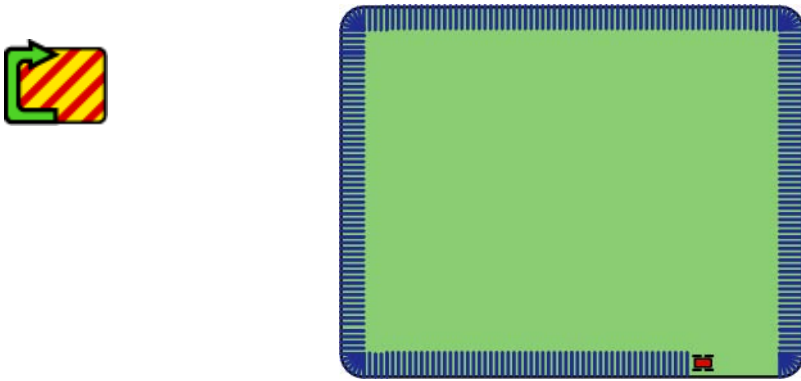

Figure 4-24: Applying the First Headland Pass

Step 2: Select Headland Off Mode

When you have completed the last headland pass, press the Headland Off button. The data you collected between pressing the Headland On and then the Headland Off buttons are now considered the data you want to represent the applied headland portion of the field. Figure 25 shows the vehicle applying the second headland pass. The Headland OFF button is shown to the left.

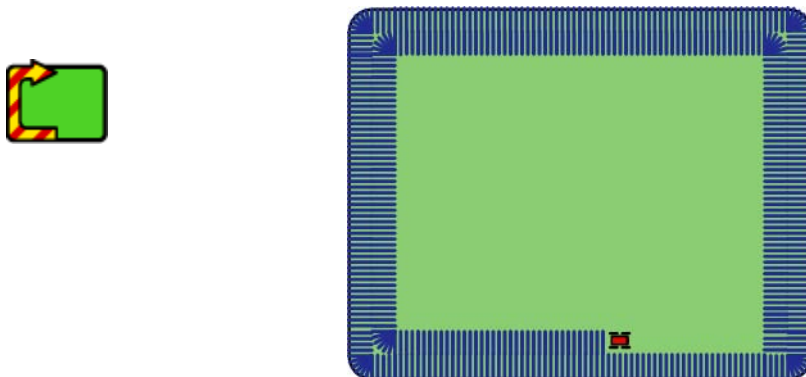

Figure 4-25: Applying the Second Headland Pass

Step 3: Establish First Interior Pass

Once you have completed all of your headland passes and the Headland Off button has been pressed, you can begin applying the first interior pass. Because you have not pressed the Ignore Headland button, you can still use the headland trajectory for guidance. Pull along side any headland trajectory and begin applying, the lightbar should begin to display guidance information. Figure 26 shows the vehicle applying the first interior pass.

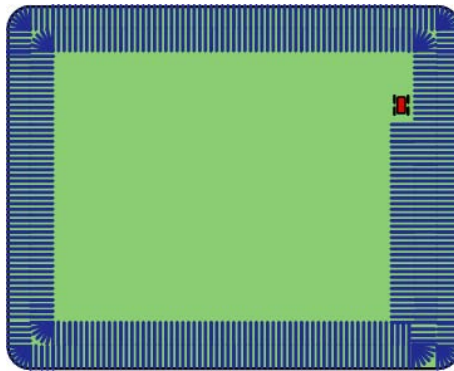

Figure 4-26: Applying the First Interior Pass

Step 4: Ignore Headland Data

Once the first interior pass has been completed and you intend to continue applying in the interior of the field, switch to the Ignore Headland pattern. To do this press the current Guidance Pattern soft-key (should be Headland) and select the Ignore Headland pattern. For more information on how to switch between guidance patterns see (Changing Guidance Pattern on page 5-13). This will exclude the headland data from guidance. Figure 27 shows the headland data (depicted by checker board pattern) excluded from the guidance data. The Ignore Headland button is shown to the left.

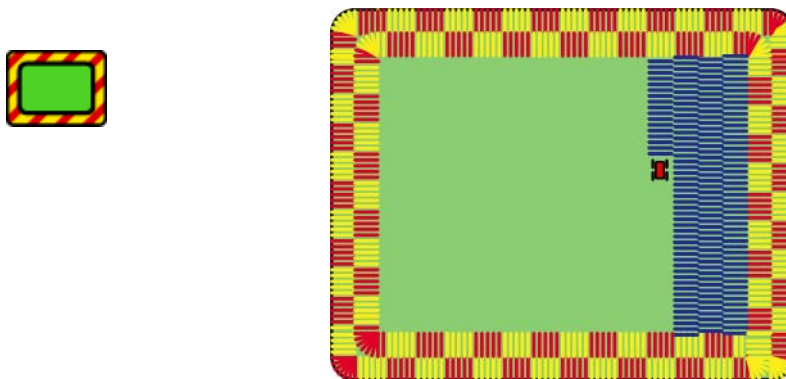

Figure 4-27: Applying the Interior in Ignore Headland Mode

You can continue applying the interior of the field in the ignore headland mode. If for any reason you need to include the headland data again.

Fieldware for the Legacy 6000

Software Version 2.11

If you forgot to turn headland off after turning it on, you can:

- consider all sprayed passes as part of the headland.
- Complete their current pass,
- Press the Headland Off soft-key,
- Make a pass guiding along the headland (last pass),
- Switch to Ignore headland mode.
- Continue making passes.

If you forgot to start a headland, you can:

- Complete the current pass
- Spray a headland (Headland on/off) within the portion of the field that has not been sprayed.
- Continue as if a headland was originally sprayed.

The Circle Pivot Pattern

This section describes how to operate the Circle Pivot pattern. The Circle Pivot pattern is used when the operator wants to apply product in a center pivot field while being guided along a circular guideline that matches the center pivot radius.

The Circle Pivot pattern operates very similar to the Parallel pattern. The operator marks an A point, drives along the arc that the pivot would create, a wheel track is a good guide, then marks a B point. When the B point is marked, a circular guideline appears in the Map page and the operator is guided along this circular guideline. As the operator completes one circular pass and moves in either direction (left or right) to the next guideline, the software automatically creates the next circular guideline.

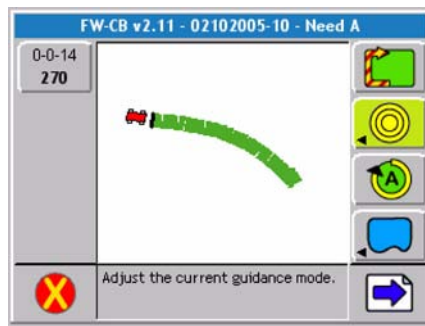

Figure 4-28: Operating in Circle Pivot Pattern

Circle Pivot Example

Marking Point A

In this example the operator wants to apply product to a portion of a field that has a center pivot on it. The operator drives around this portion creating a headland. While driving parallel to an existing wheel track the operator marks the initial A point. Figure 4-28 shows the operator beginning to drive along the center pivot perimeter. The operator has not pressed the Mark A button yet and is notified on the lightbar to do so. Figure 4-29 shows the vehicle beginning to drive along the existing wheel track and marking point A. In this example the operator has elected to drive a single headland pass. This is not necessary, the operator could have driven along the wheel track and marked points A and B and then started driving back and forth moving towards or away from the center of the pivot.



Figure 4-29: Marking Point A in Circle Pivot Pattern

Marking Point B

When point A is marked, the operator should drive along the pivot circle until they feel they have described the circle as well as possible. The Mark A button has changed to Mark B button, (Figure 4-30). Fieldware does not allow the user to mark point B within 12 seconds of marking point A. After 12 seconds, the Mark B button becomes active and the operator can mark point B anytime.

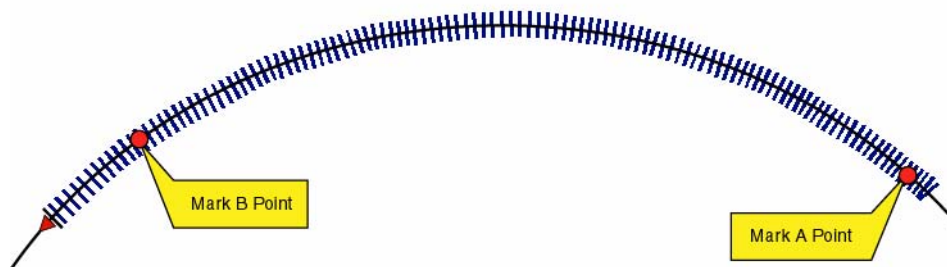

Figure 4-30: Operating in Circle Pivot Pattern

Driving in the Circle Pivot Pattern

When the operator has marked point B, the circle guideline appears in the Map page and the lightbar begins providing guidance instructions. It is not necessary to drive the entire circumference of the center pivot in order to initiate guidance. As shown in this example, the operator drove only a portion of the circumference, marking points A and B, and then used the guideline to continue driving the remainder of the circle, see Figure 4-30.

In Figure 4-31 the operator has completed driving the headlands. Next the operator lines up to drive the first swath to the inside of the headlands. Circle Pivot mode works very similar to Parallel mode, the software automatically guides the vehicle along the closest circle guideline, see Figure 4-32.

When applying in Circle Pivot pattern, the lightbar displays the curved vehicle path in the text display (top section of lightbar) and cross track error information is conveyed via the cross track LEDs. For more information on the curved vehicle path see (Lightbar Curved Guidance Graphics on page 5-27).

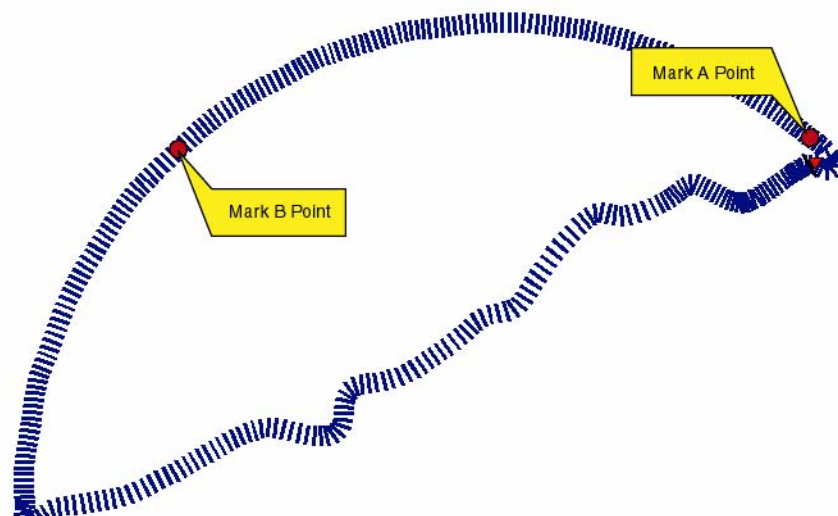

Figure 4-31: Completing Headland Circuit in Circle Pivot Pattern

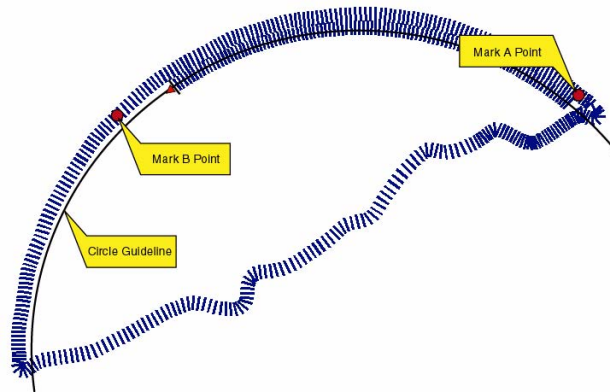

Figure 4-32: Guiding Along Field Headland

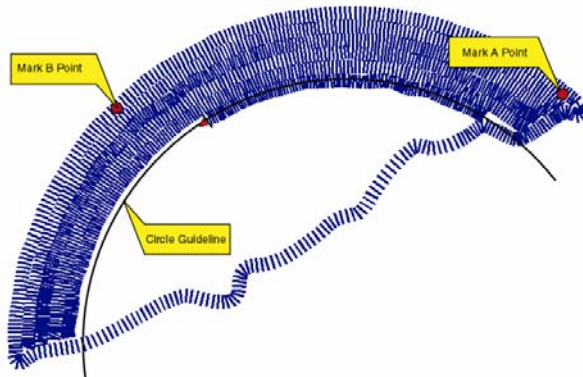

Figure 4-33: Operating in Circle Pivot Pattern

Figure 4-33 shows product application in progress and Figure 4-34 shows the completed portion of the center pivot.

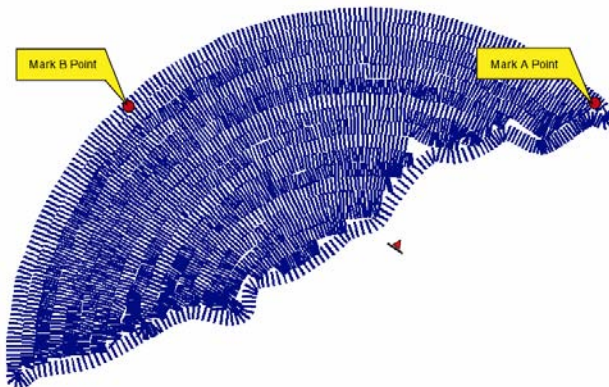

Figure 4-34: Completed Field in Circle Pivot Pattern

Lightbar Curved Guidance Graphics

Fieldware's two curved guidance techniques employ a lightbar text display graphic that aids the operator when navigating parallel to a curved swath. The X-Track LED method that is employed in Parallel mode is also employed when driving curved guidance.

A projected swath-path graphic is displayed in the text display area of the lightbar, see Figure 4-35. This projected path is made up of four horizontal bars. The bottom bar is closest to the vehicle and the top bar is the path furthest away. The width of the bars decrease as they move away from the vehicle. This adds a perspective view to the path ahead of the vehicle. The projected distance the first bar is from the front of the vehicle is based on the vehicle speed. The lightbar in Figure 4-35 informs the user to drive straight, and there are no turns approaching. In Figure 4-36 the lightbar indicates the vehicle is approaching a turn to the right. The X-Track LEDs indicate that the vehicle is slightly to the right of the guideline. Lightbar X-Track LEDs were set up in Swath mode. Therefore the user must correct to the left to get back on line. The X-Track LEDs do not provide any information relating to the curved path ahead of the vehicle, they only indicate where the vehicle is with respect to the guideline at the current vehicle location.

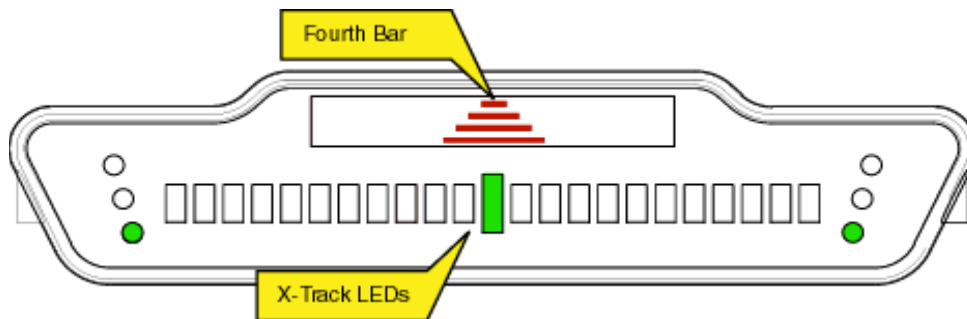

Figure 4-35: Curved Guidance Lightbar Graphics

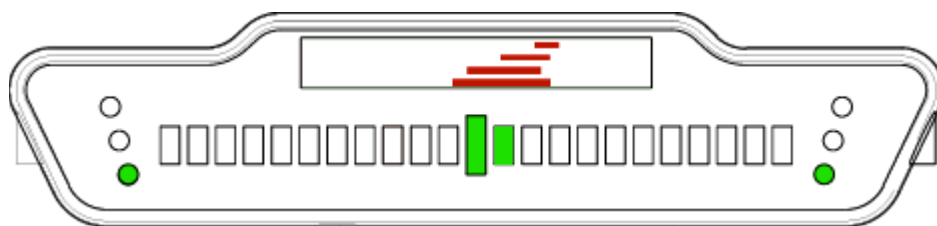

Figure 4-36: Right-Hand Turn Ahead

Applied Area Detection

Fieldware detects when the vehicle has entered a previously applied area and can also be setup to notify the operator when approaching a previously marked hazard. To use applied area detection the Lightbar Setup - Alarm menu field must be setup prior to starting guidance. See (Lightbar Setup on page 5-9) of this User Guide for more details on how to set up this menu field.

Detecting A Previously Applied Area

Figure 4-37 shows how previously applied area detection works. As the vehicle enters a previously applied area, the lightbar displays the message APPLIED and the Red stop lights illuminate. If the vehicle continues to apply product while driving in a previously applied area the console alarm sounds. If product application is turned off while in a previously applied area, the alarm will not sound. When the vehicle exits the previously applied area, the Red stop light turns off or changes to Green if product application is turned on. The Green illuminated stop light indicates that the vehicle is completely outside a previously applied area and product application should be underway.

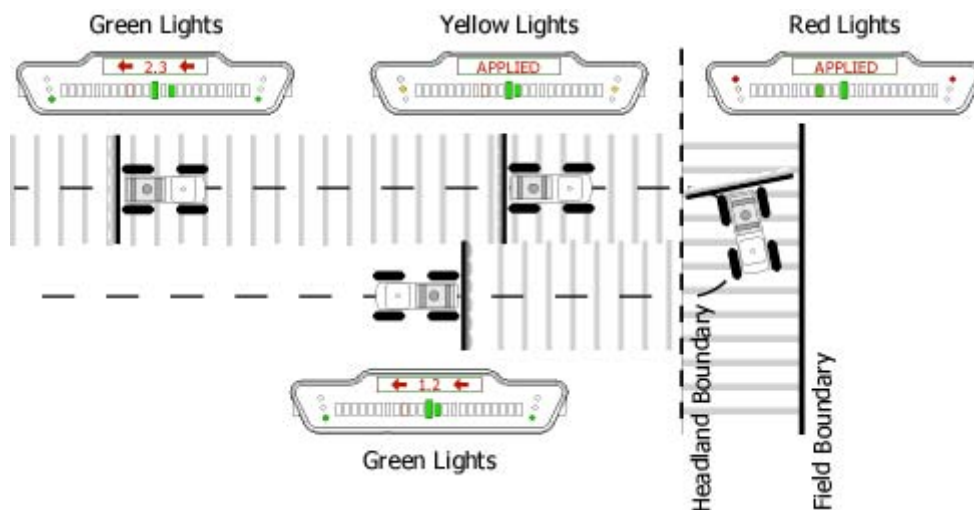

Figure 4-37: Applied Area Detection in Headlands

Detecting Neighboring Swath

Applied area detection does not notify the user if the vehicle crosses into a previously applied neighboring swath. Figure 4-38 shows an Applied Area Overlap example. The vehicle can overlap up to 25% of the Swath Width without being notified. When the edge of the vehicle swath overlaps 25% or more into a neighboring swath, the lightbar displays the APPLIED message and the Red stop lights illuminate. The alarm sounds only if product application continues. No Yellow warning lights occur in this situation.

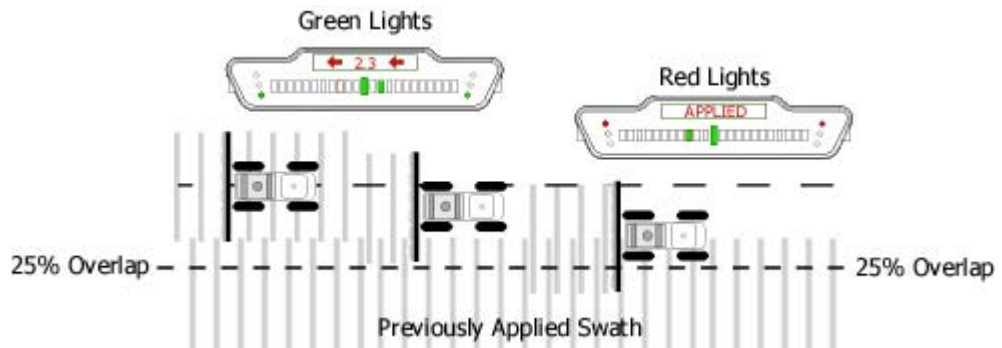

Figure 4-38: Applied Area Overlap in Neighboring Swath

Mapping a Field Boundary

Fieldware for the Legacy 6000 allows the creation of a map of the field boundary while applying product around the perimeter of the field. A field boundary can be created in all four guidance options; Parallel, Curved, Headland, and Circle Pivot. The field boundary data is stored in the file that was named in the ARM Setup menu (See “ARM Setup” on page 3-31.).

When product application is started, a Map Boundary soft-key is added to the right-hand button column in the Map page, (Figure 4-39). To start mapping the field boundary, align the edge of the vehicle swath with the edge of the field boundary, press the Map Boundary soft-key, and select which side of the swath is used to trace the field boundary. When the vehicle starts moving, a line representing the field boundary is drawn off the end of the swath (Figure 4-39). When the boundary mapping process has started, the lightbar displays MAP BND as well as an arrow indicating which side of the vehicle is being used to create the boundary. Typically product is applied and the initial guideline established while driving the field perimeter. Figure 4-40 shows the vehicle creating the field boundary while establishing the initial guideline and applying product.

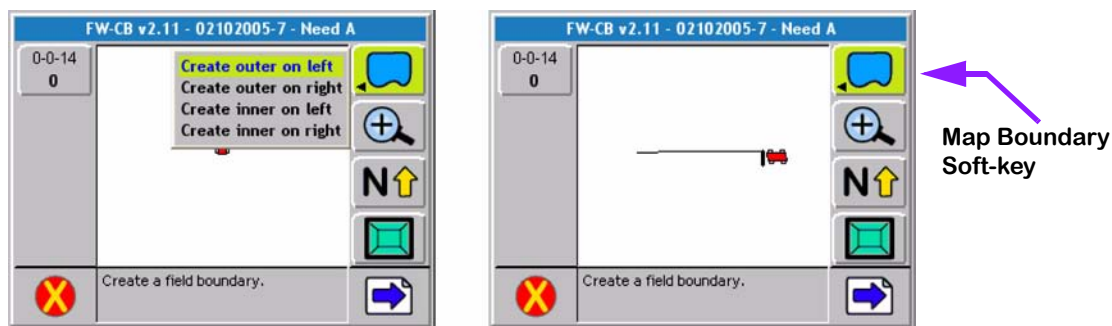

Figure 4-39: Mapping a Field Boundary

Closing or Pausing the Boundary Mapping Process

To close or pause the boundary mapping process, press the Map Boundary soft-key. A side menu appears, with the menu choices Close or Off. Selecting Close stops the boundary mapping process and draws a line between the starting point and the vehicle location where the boundary was closed. Pressing Off allows boundary mapping to be temporarily stopped. To start mapping the boundary again, press the Map Boundary soft-key and select Create on Right or Create on Left. This starts mapping the boundary again, and draws a line between where mapping stopped and where it is starting again.

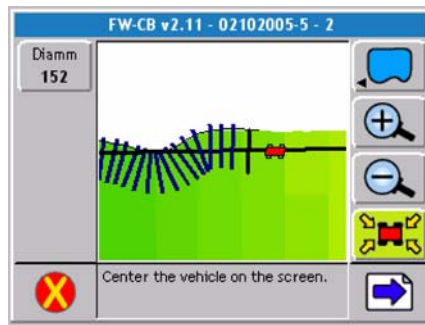

Figure 4-40: Marking Initial Guideline

Figure 4-41 shows the vehicle about to complete driving the field perimeter. The initial guideline has been established and a product application map is being created while mapping the field boundary. When the vehicle approaches the starting point, within approximately 30 ft. (10 m), the boundary automatically closes.

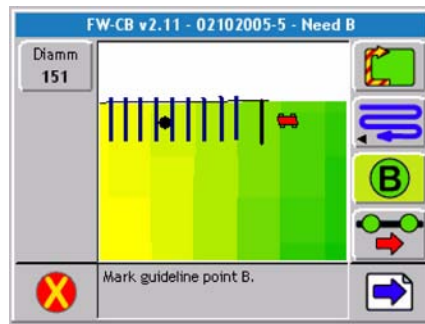

Figure 4-41: Mapping Boundary while Applying Product

Mapping Points and Hazards

Mapping points and hazards during the product application process is another feature of Fieldware for the Legacy 6000. There are two types of mapping objects that can be selected; Point and Hazard. Each of these object types are described in more detail below.

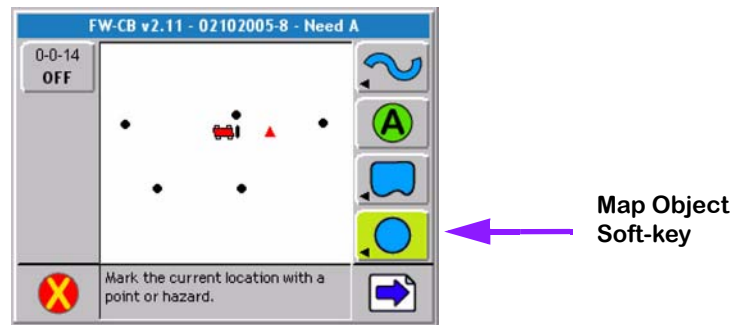

Figure 4-42: The Point Soft-key

Marking a Point

The map object Point allows a point to be marked at the vehicle location. To map a point drive to the location of the object or feature to be mapped, this location should coincide with the location of the GPS antenna. Press the Map Object soft-key. A side menu appears with the point and hazard symbols in the list (Figure 4-42). Select the Point symbol to map a point. When Enter is pressed, the Point Name dialog box appears, (Figure 4-43). Enter the name of the point using the arrow keys and press Enter to accept the point name and return to the map page.

The Name Point dialog remembers your 10 most recent entries. To select a recent entry, scroll through the dialog window, using the arrow keys, and select the desired point name. If the point is not named, select the No Name setting in the dialog window and press Enter.

To add a new name, press the New Name soft-key. This brings up a name input dialog that allows a new name to be entered.

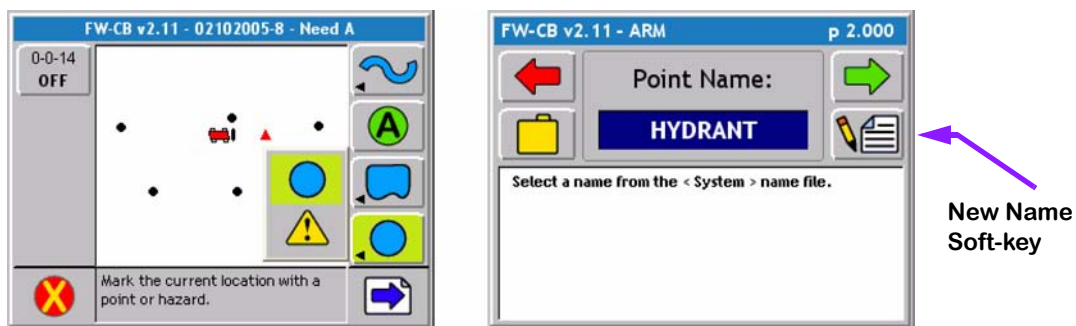

Figure 4-43: The Map Point and Naming Point

Marking a Hazard

The map object Hazard allows a hazard to be marked at the vehicle location. The map object Hazard can be used later in Hazard Detection to notify the operator of potentially hazardous objects or features within the field. Hazard detection does not work with point objects.

To map a hazard, drive to the location of the object or feature to be mapped. This location should coincide with the location of the GPS antenna. Press the Map Object soft-key. A side menu appears with the point and hazard symbols in the list (Figure 4-42). Select the Hazard symbol to map a hazard. When Enter is pressed, the Hazard Name dialog box appears (Figure 44). Enter the name of the hazard using the arrow keys. Press Enter to accept the hazard name and return to the map page.

The Name Hazard dialog remembers the 10 most recent entries. To select a recent entry, scroll through the dialog window, using the arrow keys, and select the desired object name. If the object is not named, select the No Name setting in the dialog window and press Enter.

To add a new name, press the New Name soft-key. This brings up a name input dialog that allows a new object name to be entered.

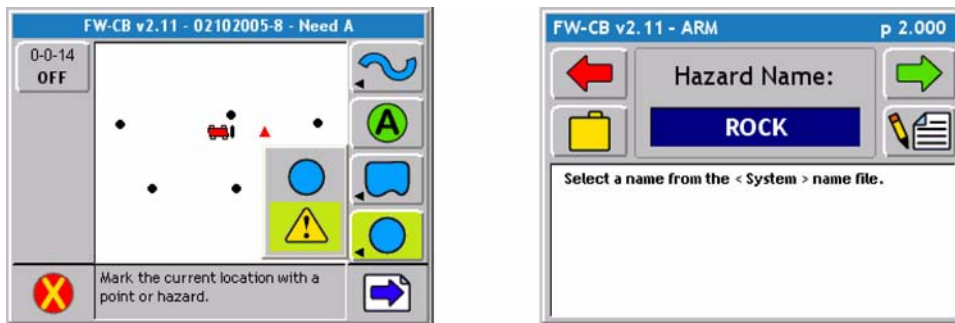

Figure 4-44: Naming the Hazard

Object Name File

You may create a simple text file of names you commonly use while applying. Typically user have a weeds file; this allows them to simply select a weed name instead of trying to type it in. To learn how to build a names file, see the Fieldware Tools/Map Manager user's guide. Once you have a names file ready you need to load it into the Legacy 6000 console memory. To do this place the names file in the /sys/names folder on the root of your PC card. Go to System Tools device manager (Book Reference Chapter 2). Select Console as the device and run "Update console using System files located on the PC card". Select Object Names from the Update Files list. Press the enter key to update the names files.

Exiting Real-Time Operation



To exit from real-time operation, press the Exit button located on the bottom left hand corner of the current page. If data is being stored to the PC card, the exiting process may take a minute or so to properly store this data.

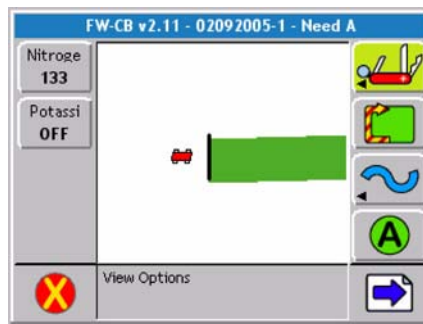

Figure 4-45: Exiting Real-time Application

Fieldware-Map Manager

Some Legacy 6000 system kits include Fieldware Tools for an office computer or laptop. Fieldware Map Manager Tools can be used to view application as applied maps. Figure 4-46 shows an as-applied map (RCD) and field boundary (BND) in the Map Manager view. To view as applied maps, copy the record files (RCD) from the PC card to a desktop or laptop computer. Review 98-05048 Fieldware Tools user guide for instructions on how to generate application reports from the data.

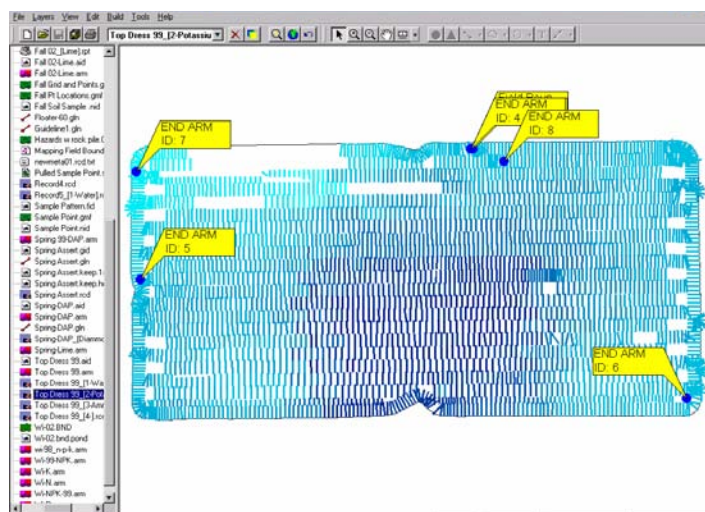

Figure 4-46: As- Applied Data Viewed in Map Manager

Lightbar Index

The Swath XL Lightbar is capable of displaying a considerable amount of information to the user. This information can be represented as text in the display window, illuminated lights on the stop light or cross track LEDs, or a combination of text and lights. Information displayed on the lightbar depends on both user defined settings and system warnings not controlled by the user. Table 4-3 describes each possible lightbar state and possible information that could be displayed.

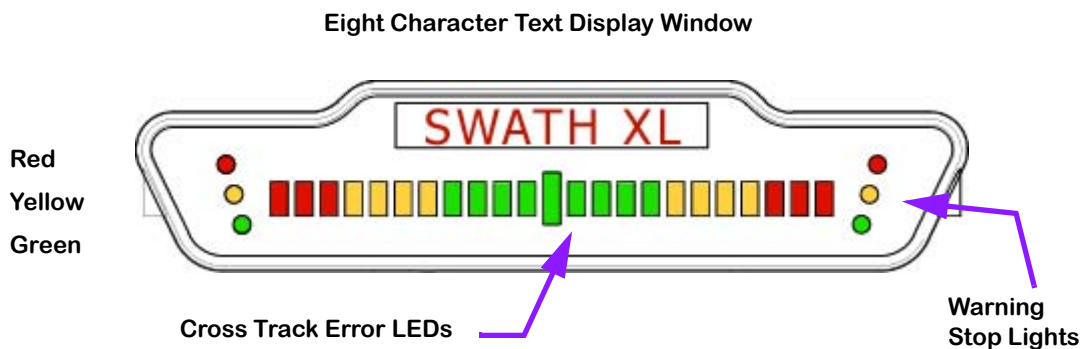

Figure 4-47: The Swath XL Lightbar

Lightbar State	Description
	Mark A: Displayed when establishing the guidance point A of the initial guideline.
	Mark B: Displayed when establishing the guidance point B of the initial guideline.
	Swath #: A user selected lightbar message. When not on the initial guideline the first character is either L or R for Left and Right of the initial guideline. The number identifies how many lines left or right of the initial guideline.

Table 4-3: Swath XL Lightbar Index







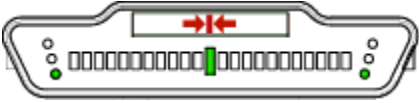

Lightbar State	Description
	<p>X-Track Error: A user defined lightbar message. This cross track error message is displayed when the vehicle is on the guideline and there is no error.</p>
	<p>X-Track Error: A user defined lightbar message. In this example the operator should steer to the left 2.3 ft. (Assuming the system unit is set to US and Lightbar is set to Swath mode.)</p>
	<p>Vehicle Heading Error: A user defined lightbar message indicating the current heading error between vehicle heading and the bearing of the guideline in degrees and decimal degrees. The arrow indicates steering direction.</p>
	<p>Ground Speed: A user defined lightbar message indicating the vehicle speed in Miles per Hour (MPH). System unit is set to US.</p>
	<p>Ground Speed: A user defined lightbar message indicating the vehicle speed in Kilometers per Hour (KPH). System unit is set to Metric.</p>
	<p>Course on Ground (COG): A user defined lightbar message indicating the vehicles heading in degrees 0 to 359. The example to the left indicates the vehicle's course on the ground is due South (180 degrees).</p>
	<p>Area Applied: A user defined lightbar message indicating the current amount of area applied in Acres. System unit set to US.</p>
	<p>Area Applied: A user defined lightbar message indicating the current amount of area applied in Hectares. System unit set to Metric.</p>
	<p>Applied Area Detection: This message is displayed when the vehicle is within a previously applied area. Note that the Red stop lights are illuminated. At this point an alarm should sound. See (Applied Area Detection on page 5-28).</p>
	<p>Curved guidance information graphics. The four horizontal bars in the text display represent a perspective view of the swath ahead of the vehicle. The bars skew left or right to represent the curved path ahead.</p>

Table 4-3: Swath XL Lightbar Index

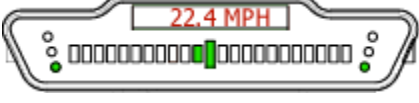





Lightbar State	Description
	<p>Hazard Detection: The name of the hazard is displayed when the vehicle is approaching an existing hazard. Note the Yellow stop lights are illuminated indicating the initial warning.</p>
	<p>Hazard Detection: The name of the hazard is displayed when the vehicle is approaching an existing hazard. Note the Red stop lights are illuminated indicating the final warning.</p>
	<p>Mapping Boundary: This message is displayed when the user is mapping the field boundary. The arrow symbol on the left indicates the field boundary is on the left side of the vehicle. (See "Mapping a Field Boundary" on page 4-30.)</p>
	<p>Mapping Boundary: This message is displayed when the user is mapping the field boundary. The arrow symbol on the right indicates the field boundary is on the right side of the vehicle. (See "Mapping a Field Boundary" on page 4-30.)</p>
	<p>System Warning: The message is displayed when there is loss of GPS differential corrections. Guidance calculations are stopped until differential corrections resume.</p>
	<p>System Warning: This message is displayed when there is a complete loss of GPS signal to the GPS receiver or Smart-pad. Guidance calculations are stopped until DGPS signal resumes.</p>
	<p>Lightbar Version Message: This message is displayed when the user runs the Lightbar Test. M 4 indicates the lightbar model number and the 2.0 indicates the lightbar protocol version number. This number varies and is based on lightbar version and model.</p>

Table 4-3: Swath XL Lightbar Index

Data Transfer and Report Generation

Data collected to the PC card in the Legacy 6000 console can be transferred to a desktop or laptop computer. When transferred to a computer, an Application Report can be generated using the Fieldware Map Manager program.

Chapter Notes

Chapter 5 - System Tools

System Diagnostics "Fieldware for the Legacy 6000".
Software Version 2.11

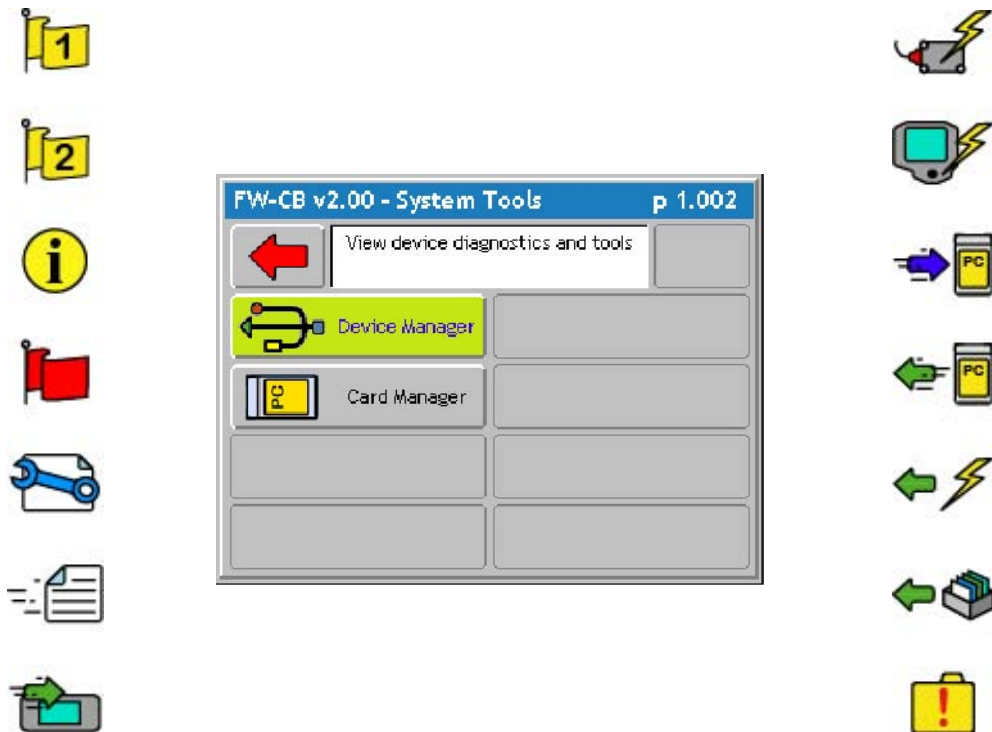

System Tools

System Tools allows some basic system diagnostics to be performed. System Tools is accessed from the Main Launcher page. To access the System Tools launcher, press the Tools button in the Main Launcher page (the help text should say *View System Tools*). This action brings up the System Tools launcher page. Table 5-1 below lists the current System Tools. Each tool is covered in more detail in sections below.

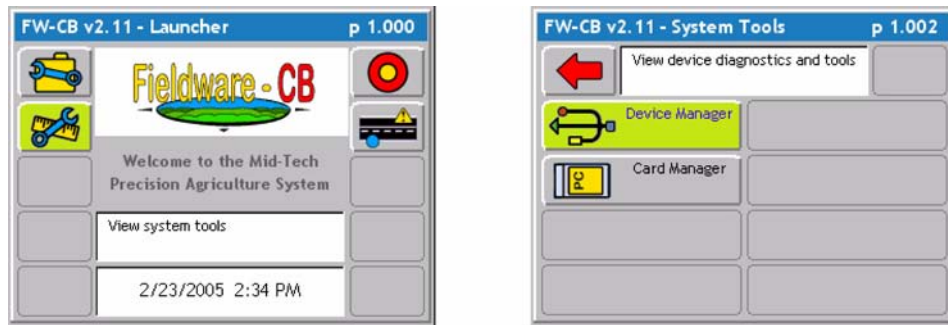

Figure 5-1: The Main Launcher

Tool	Description
<p>Device Manager</p>	<p>This tool allows the viewing of all components on the Legacy system including the Mid-Tech CAN Bus, external rate controller, and GPS receiver.</p>
<p>Card Manager</p>	<p>This application runs in conjunction with the PC card. The card must be inserted to run this application. Card manager allows basic file manipulation.</p>

Table 5-1: System Tools

Device Manager

This tool allows the viewing of all components connected to the Mid-Tech Legacy 6000 system. In Fieldware - CB, the CAN Bus, GPS Receiver, Lightbar, PCM, SSM, PSM and Console are available for diagnostics. Scroll through all of the connected devices and review the current status of these devices by selecting the Information “i” button. From the information page detailed information about each device can be viewed.

Information “i”

CAN Bus

When selecting CAN Bus as the device for diagnostics, a CAN Bus Information page is displayed, listing all components connected to the CAN Bus serial number and version number.

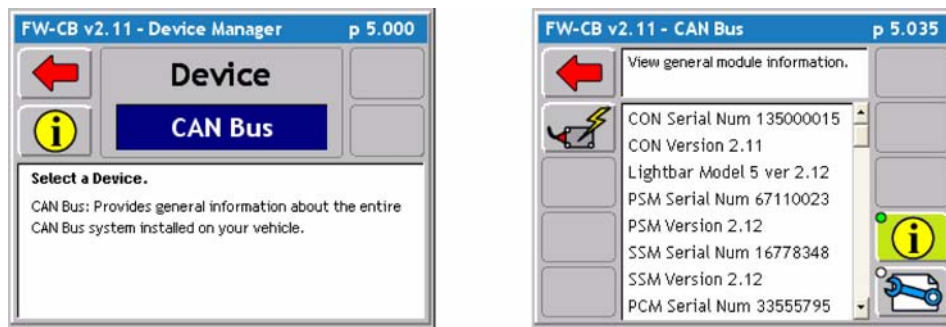

Figure 5-2: The Console Information Page

CAN Bus SofKeys and Description



Button	Description
	Reset all Modules to factory settings. There are two types of resets, Settings and Arbitration. Settings - This will reset all modules to factory defaults. Bus history will be retained in the PSM so modules will not be seen as new. Arbitration - Erase Bus history so all modules are seen as new. All other module settings will be retained.
	View general module information. View serial numbers and software versions of all components connected to the Bus.
	View CAN Bus statistics.

Table 5-2: Console System File Functions

GPS Receiver

This tool allows the viewing of any GPS data coming into the com port on the Legacy 6000. It is recommended this diagnostic be run the first time the GPS receiver is connected to the Legacy 6000 console.

To access the GPS Receiver diagnostic page from the Main Launcher page / System Tools page / GPS Receiver.

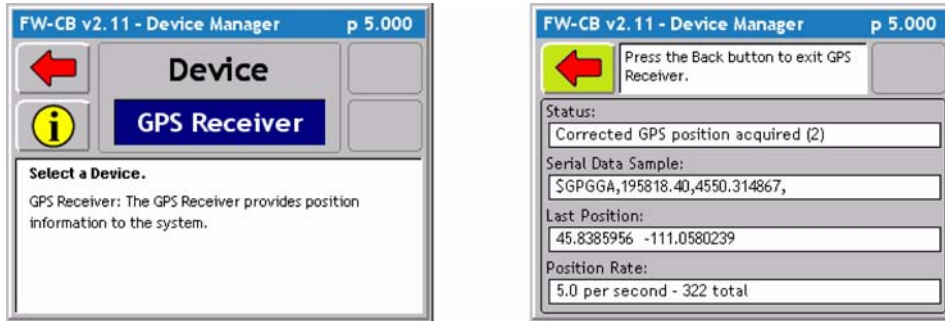

Figure 5-3: The GPS Receiver Diagnostic Page

LightBar

When selecting Lightbar as the device for diagnostics, a Lightbar Information page is displayed, listing the Lightbar version number and lightbar test option

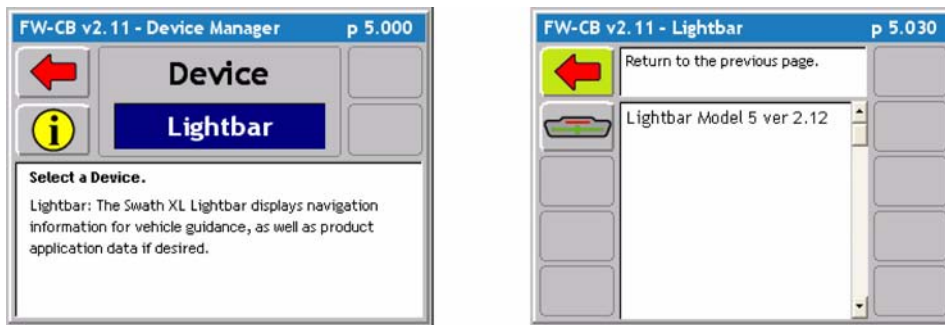



Figure 5-4:

Lightbar SoftKeys and Description

Button	Description
	Performs a test on the lightbar to ensure LED functionality and communication.

PCM, SSM, and PSM

When selecting one of the Modules as the device for diagnostics, a Module Information page is displayed, listing the Module serial number and version number.

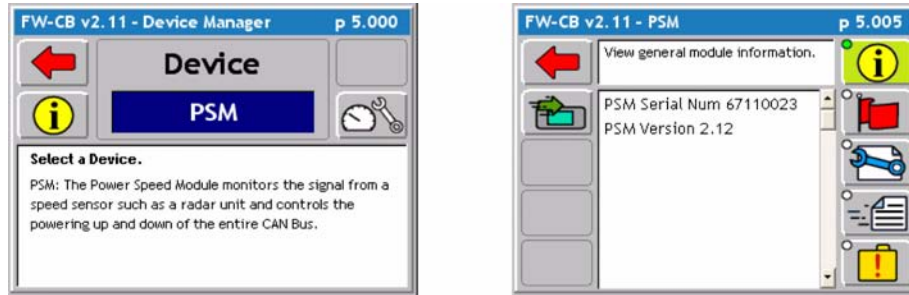

Figure 5-5: The Console Information Page

PCM, SSM, & PSM SoftKeys and Description

Button	Description
	Update the module's flash. Software must be loaded on the PC card for the Module to be updated. Contact Mid-Tech for update support.
	View general module information. Module serial numbers and software version.
	View Module Flags 1. System diagnostic tool that identifies the active functions on the PCM.
	View Module Flags 2. System diagnostic tool that identifies the active functions on the PCM.
	View Module Flags. System diagnostic tool that identifies the active functions on the PSM and SSM.
	View modules current configuration.
	View Messages currently being sent by the module
	View the error log from this module.

Table 5-3: Console System File Functions

Console

When selecting Console as the device for diagnostics, a Console Information page is displayed, listing the console serial number and version number

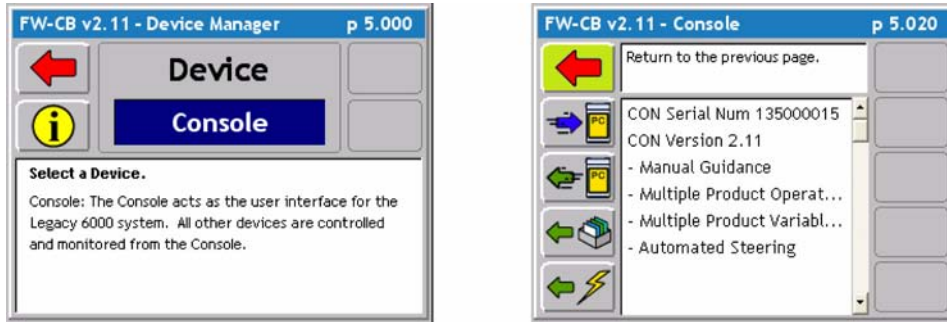

Figure 5-6:

Console SoftKeys and Description

Button	Description
	System File Backup. Press this button and the console system files are backed up to the PC card.
	Update Console System Files. Press this button to update the console system files with system files located on the PC card.
	Imports Name Manager files and in the future other Map Manager system related files into the Legacy 6000 system flash.
	Erase Removable System files. Press this to remove system files from flash. System files for Fieldware - SA include Name files. Press this button to see a list of files that can be erased.
	Reset Console. Press this button to reset the console to its default factory settings.

Fieldware for the Legacy 6000

Software Version 2.11



The Plug-Ins activated can be reviewed from the Console Information page.

Backing up Console System Files

The Legacy 6000 (L6K) system files can be backed up to a PC card. This allows the system to be restored at a later date or transferred to another L6K console if necessary.

Required Items:

- 20 Meg (or larger) ATA Flash PC Card

CAUTION: Always make sure that the console is powered off before inserting or removing the PC card.

With the console powered down, insert a blank PC card into the Legacy 6000 console and power up the console.

From the Main Launcher page, select System Tools / Device Manager / Console / Backup Console System Files. The message "Performing console backup" appears. When the backup operation has completed, turn the console off and remove the PC Card.

Restoring Console System Files

With the console powered down, insert the PC card, containing the desired system files, into the Legacy 6000 console and power up the console.

From the Main Launcher page, select System Tools / Device Manager / Console / Update Console. The message "Update Files" appears. Select ALL and press the Enter key. The message "Updating console" appears. When the restore operation has completed, turn the console off and remove the PC Card.

Importing Object Name Files into Console Memory

Fieldware - SA allows Object Name Files to be imported. An Object Name File is a simple text file that contains a list of Point and Hazard object names that are commonly used during product application and mapping. Using an Object Name file helps to efficiently store, select, and name mapping objects while out in the field. File names can be named for a specific task or theme such as Field Mapping or Weeds. It is possible to access these object name files when mapping points or hazards during the real-time mapping process (see Mapping Points and Hazards on page 4-32).

Object Name files are ASCII text files, (.TXT). These files can be created in several editors, spread sheets and word processors. A single column of names typed into an Excel spread sheet can be copied to the Windows clipboard and pasted into any names data base file. This makes it easy to move existing attribute information into the names data base file format. It may be easier to simply type name attributes (one name per line) into a word process or editor, and save that file as a text file with the extension (.TXT). Object Name files can also be built in the Fieldware Map Manager software.

When the names file is ready to place in the memory of the Legacy 6000 console it is necessary to do the following:

- Copy the names file to a PC card and place it in the /sys/names/ folder. If these folders do not exist, it is necessary to create them prior to moving the names file over. Place the PC card in the console and power the unit On.
- Go to System Tools Device Manager and select Console as the device.
- Press the Update Console System Files soft-key, and select Object Names as the Update File. Press the Enter key. This places the names files, located in the /Sys/Names folder, into the Consoles system memory.

Card Manager

Card Manager is an application that allows basic file manipulations such as cut, copy, and paste to files on a PC card. The PC card must be inserted into the Legacy console prior to using Card Manager.

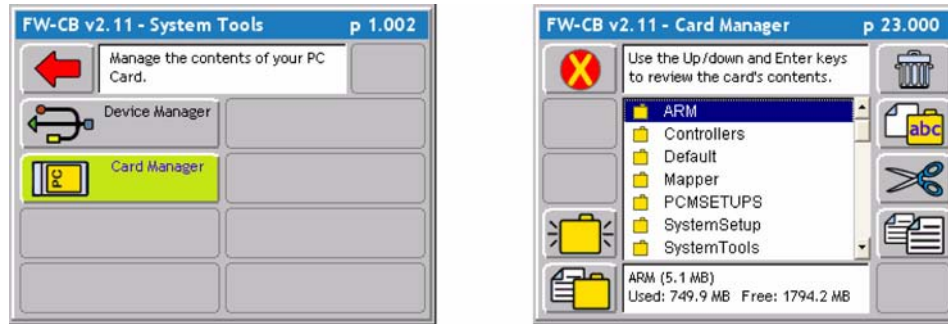

Figure 5-7: The Card Manager Page

Card Manager SoftKeys and Description







Button	Description
	Create a New Folder - Press this button to create a new folder at the current location on the PC card. A prompt to name the folder appears when this button is pressed.
	Move Up - Press this to close the current folder and move up one folder level. To move down a folder level from the current position, highlight the desired folder name in the File/Folder list and press the Enter key.
	File/Folder properties - Press this to display a properties dialog box listing specific information about the highlighted file or folder.
	Delete File or Folder - Highlight the file or folder to be deleted and press this button.
	Rename File/Folder - Highlight the file or folder to be renamed and press this button. A rename file or folder dialog appears.
	Cut File or Folder - To cut a file or folder and move it to a new location, press this button. Then move to the desired location and press the Paste button.

Table 5-4: Card Manager Functions



Button	Description
	Copy File or Folder - To copy a file or folder and paste it to a new location press this button. Then move to the desired location and press the Paste button
	Paste File/Folder - When the desired File/Folder has been Cut or Copied, navigate to the target location and press this button to paste it.
	Exit - Press this to exit the Card manager application.

Table 5-4: Card Manager Functions

Chapter Notes

Chapter 6 - Running Mapper

Mapper for the Legacy 6000.

Software Version 2.11

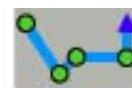

Mapper Introduction

Mapping specific locations in a field is an important requirement in precision agriculture. The Mapper program allows the operator to Map specific locations or more generalized areas of a field. Once a desired location is mapped the operator can then return to that location at a later date or use that map as a background for future use. The primary use of the Mapper program will be for mapping specific items such as boundaries, weed patches, Insect infestation, wet areas, Tile lines, tile risers, poles, rocks, wholes, etc. The items mapped will be stored as a .gmf file on the data card that can be used as a background file during a Real-Time application.

The Mapper application is used without the lightbar but the data card must be inserted in the Legacy 6000.

Starting Mapper

To access the mapper application select the Highway (Mapper) button from the main launcher page. If the Mapper button is not shown on the main launcher page the PC Card option in console setup is set to No (See "Console Setup" on page 6-8.). Once the Mapper button is selected a Job name will be required.

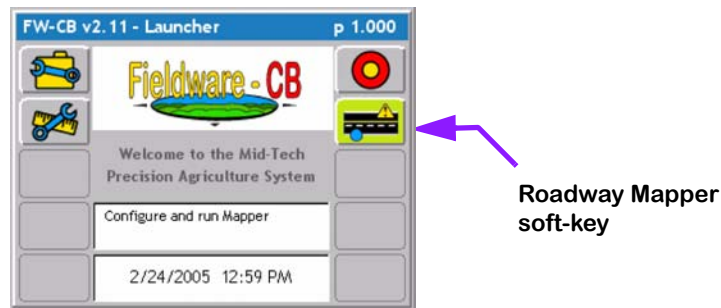

Figure 6-1: The ARM Launcher Page

Starting a Job

Pressing the Mapper button in the Fieldware Main Launcher brings up the Job page (Figure 6-2). When a Job is created a folder is created on the PC card labeled with same name. All files related to this job (Map File, Background File, and Base map File) will be stored in this folder.

There are three methods for entering/selecting a job name.

Creating a New Job

To create a new job, press the Create Job button in the Job page (Figure 6-2). This brings up the Create a Job page. There are two methods of creating a job: manually and automatically (Figure 6-3).

Selecting an Existing Job

From the Job page (Figure 6-2), select an existing Job by using the up and down arrow keys. An existing Job has an associated file folder located on the PC card. The name of the job folder is the same as the job name.

Creating a Job Based on an Existing Job

A new job can be created based on the settings of an existing job. This helpful when starting a new job and no settings need to be changed. This allows the operator to create a new job and GO! To do this, select the desired job to base the new job from. Press the (Create a job based on last job settings) button see (Figure 6-2). Create a new job name or auto name the job and then press the green forward arrow. All settings from previous job can now be viewed in from the Mapper launcher page or press the Mapper Field button to start mapping based on last job settings.

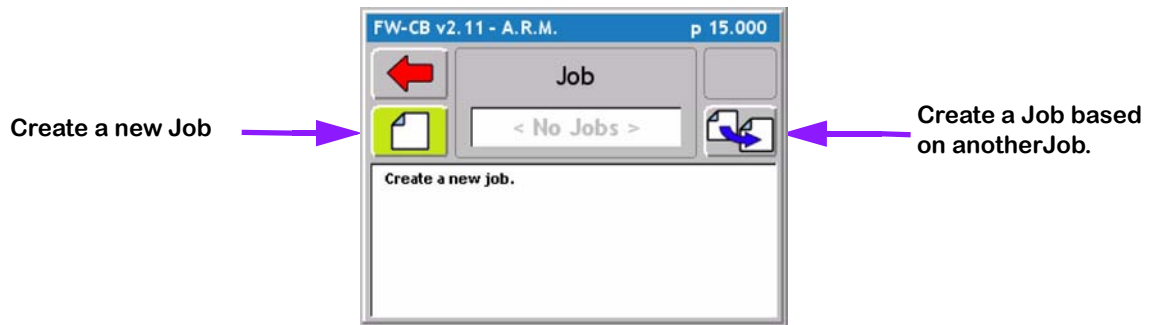

Figure 6-2: The Job Page

Manually Naming a Job

From the New Job Name page (Figure 6-3). Using the arrow keys enter the name of your job. It is not necessary to use all numbers in the job name. It can contain alpha-numbers characters. When the desired job name is entered, press the Forward Arrow to save the name and return to the Job page.

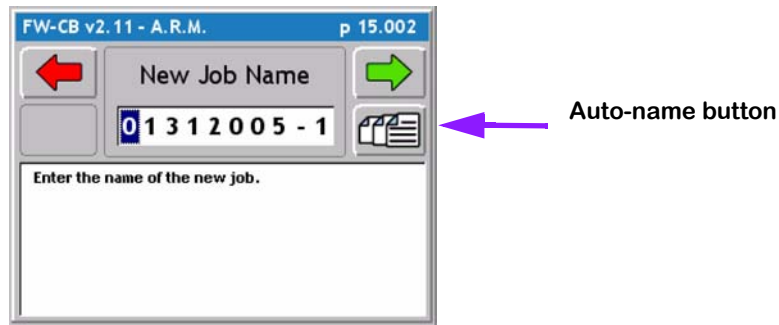

Figure 6-3: The Job Name Page

Automatically Naming a Job

The second method to create a job is to press the Auto-name button in the Create Job page. This will name the job based on the current date followed by the number that job is for the day. Therefore the first job on January 31st 2005 would automatically be named 01312005-1. The second job for the same day would be named 01312005-2.

When the Mapper Field soft-key is pressed, the Fieldware Mapper software loads the setting, parameters and data files. This loading process may take a few seconds to complete. When the loading process is complete, the Map page (Figure 6-10) is the first real-time page seen.

Mapper Setup

There are two optional setup features for Mapper that can make the Mapper application more detailed and efficient, Mapper Setup and Road Markers. No settings are needed in either of the two options for the Mapper session to begin (Table 6-1).

Mapper Setup and Operation Steps



Soft-key	Step Description
	<p>Mapper Setup. Run this setup to name data files and set the data collection rate. You must name a Map File prior to starting the real-time mapping process.</p>
	<p>Road Markers. Run this setup to pre-define point and hazard objects. A pre-defined point or hazard object has its own soft-key in the real-time Map page. Define commonly mapped objects here.</p>

Table 6-1: Mapper Setup

Mapper Setup

Mapper Setup consists of four setup parameters involving file names, importing background and Base map files as well as the collection interval time. Please review Table 6-2 for a more detailed description of each option.



Figure 6-4: Mapper Setup

Mapper Setup Options	Description
Map File	The Map File will have the same file name entered for the Job Name. The file name can be changed to better describe the application. All mapping functions, Lines, Points, Hazards, and Polygon will be stored in this file as a .gmf on the PC Card.
Background File	The Background file is a file that has been create prior to the mapper session and has been transferred to the root directory of the PC Card. An example would be points or hazards mapped during a product application such as rocks that the operator would like to return to pick up. The background file can also be a boundary file (.bnd) The files format excepted for a background are (.gmf, .bnd).
Base Map File	The Base Map File is similar to the Background file but uses a GeoTif file (.tif). This file is usually downloaded from the internet and placed on the root directory of the card. A .tif file is just a picture with georeferenced coordinates to provide location. Typical Base map files are elevation maps, and roadway maps.
Collection Intervals	The Collection Interval is how often data is written to the PC Card. The selection can range from 1/sec to 5/sec.

Table 6-2: Mapper Setup Option Description

Road Markers

To help make the mapper session more efficient the Road Markers option allows the pre-naming of commonly used points and hazard. These names will appear on the left side of the real-time map page (Figure 6-12).

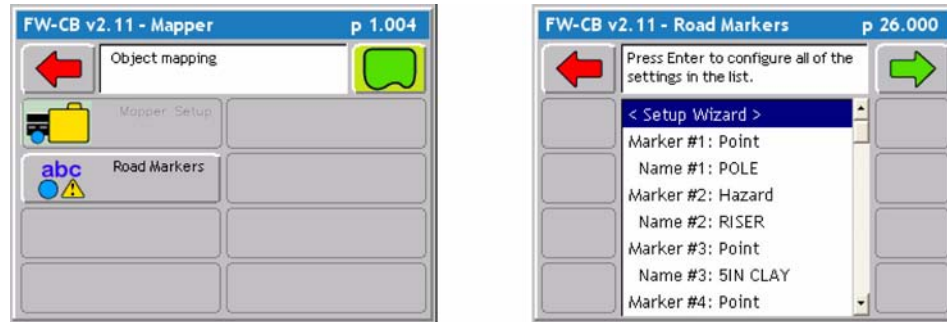

Figure 6-5: Selecting Road Markers

Parameter	Description
Marker #	The type of marker being defined: Point, Hazard, and Not Used.
Name #	The name of the marker defined above.

Table 6-3: Road Marker Setup Description

Enter Road Marker Name

To enter a road marker name select the Marker #1 and press the green enter button. Use the Up and Down arrows to select Point or Hazard and press the green forward arrow or the enter button. Next select Name #1 and enter the desired name (See "Creating Object Name" on page 6-9.) of the Point or Hazard (Figure 6-6)

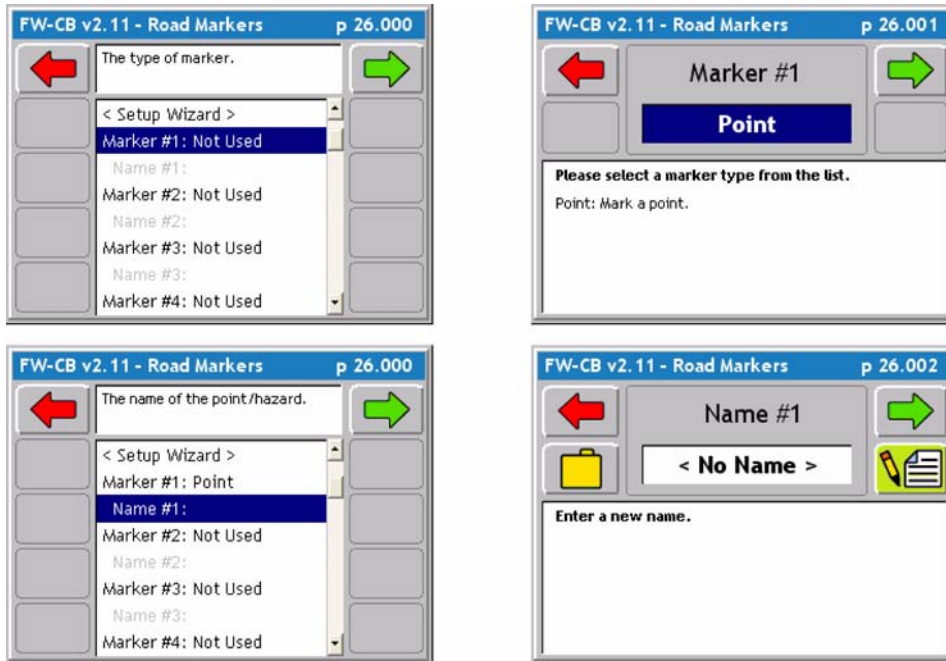

Figure 6-6: Entering Road Marker Name

Creating Object Name

Creating New Object Name

From the object name page the operator can select from existing object names or create a new name by selecting the Pencil and Paper button (Figure 6-7) left image. Enter the object name and press the green forward arrow to advance back to the next page.

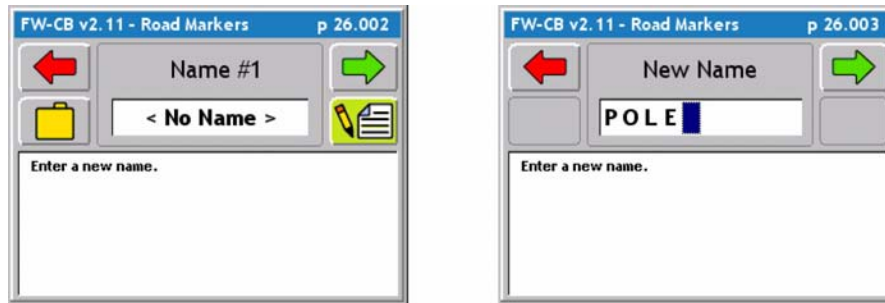

Figure 6-7: Creating a New Object Name

Creating a Folder for Object Names

From the Object Name page notice the folder button on the left side of the screen, this button allows the operator to create a folder name to store all related object names in. For example, a folder can be create called Field Tile and within that folder the Object Names created will only pertain to field tile such as 4in, 5in, riser, main etc. (Figure 6-8)

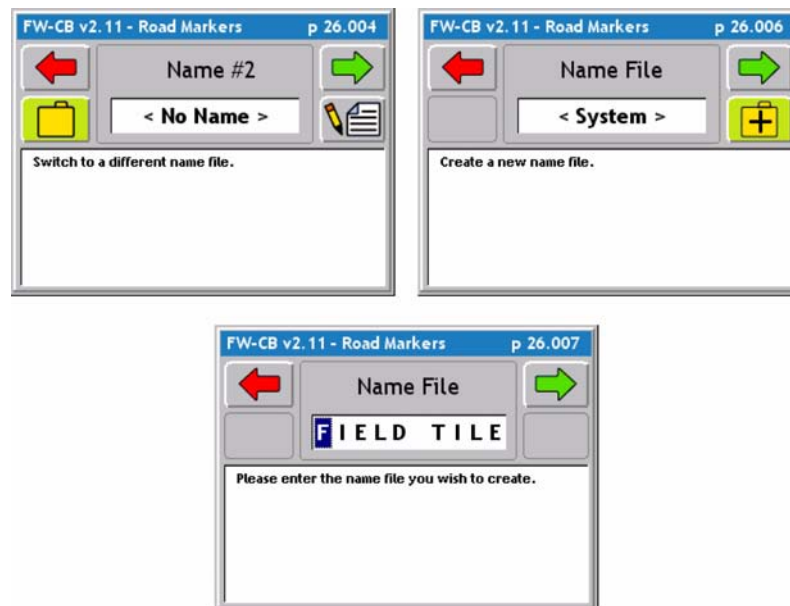

Figure 6-8: Create a Folder for Object Names

Real-time pages

To access the Mapper real-time page select the green Field button from the mapper launcher page. There are two real-time pages, an Information page and Map page. Each will be described in more detail.

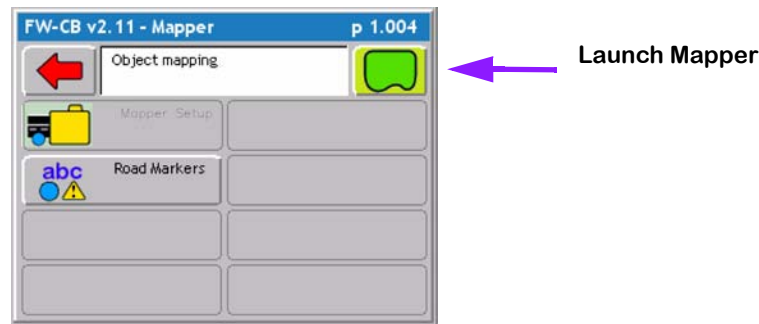

Figure 6-9: Mapper Launcher Button

Map page











The Map pages is the first page the operator will view when entering the mapper session. The map page allows the mapper application progress to be viewed. This page displays the vehicle at its current location, as well as current implement status. The application trajectory is also displayed. If displaying an Base map or back Ground Map the map is seen in the background.





All mapping related soft-keys are displayed in the right side column of the map page. See below for a description of each soft-key that can be displayed in the Map page.

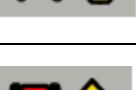

Figure 6-10: Real-Time Map Page

Map Page Soft Keys Descriptions

Soft-key	Description
	The Exit soft-key. Press to exit the Mapper real-time process and return to the Mapper Launcher page.
	The Next Page soft-key. Press to alternate between the Map page and the Navigation page.
	The Stop Alarm soft-key. Press to mute an alarm.
	The Device Manager soft-key. Press to launch Device Manager diagnostics. This is used when it is necessary to trouble shoot the devices connected to the console, including the console and GPS receiver, when running in real-time.
	The Options soft-key. Press to bring up the Options menu (see Table 6-5).
	The Zoom In soft-key. Press to decrease the area displayed in the view page. There is a total of 5 zoom levels.
	The Zoom Out soft-key. Press to increase area displayed in view page. There is a total of 5 zoom levels.
	The Full Screen soft-key. Indicates that the current display mode is "Full Screen". When pressed, the map area is reduced to allow the message area to appear at the bottom of the screen. This is useful when you want to view the descriptions of the soft-keys found on the right side of the screen.
	The Partial Screen soft-key. Indicates that the current display mode is "Partial Screen". When pressed, the map view is expanded to include the message space at the bottom of the screen. This is useful when you want to see more of the vehicle trajectory.
	The North Up View soft-key. Indicates that the current display mode is "Course On Ground" which keeps the vehicle stationary in the view page with the heading (course) of the vehicle pointing to the top of the view page. Pressing this soft-key changes the view to North Up.
	The Course on Ground (COG) View soft-key. Indicates that the current display mode is "North Up" which keeps North at the top of the view page. When pressed this soft-key changes the view to COG.

Soft-key	Description
	<p>The Center Vehicle soft-key. Press to center the vehicle in the map page.</p>
	<p>Generate Object soft-key. Pressed to bring up a menu that allows you to set up a map object to be mapped (see (Mapper Tools on page 4-14)).</p>
	<p>The Pan soft-key. Press to pan around in the map page, using the arrow keys.</p>
	<p>Antenna Offset soft-key. Press to change the antenna offset.</p>
	<p>Erase Object soft-key. Press to erase the last object or object vertex created.</p>

Information Page

There is one information page which displays the current Latitude and longitude vehicle position, Antenna Height, GPS speed, Course in degrees (North 0°), and file size.

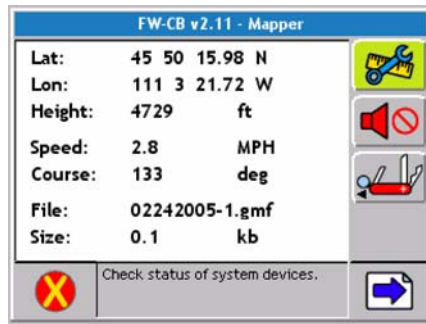







Figure 6-11: Real-Time Information Page

Information Page SoftKeys and Description

Soft-key	Description
	The Exit soft-key. When pressed Fieldware ARM exits out of the real-time process and returns to the Main Menu page.
	The Next Page soft-key. Pressing this soft-key switches between the map page and the rates page.
	The CAN Process soft-key. When pressed this soft-key launches the CAN Process diagnostic. This can be used to trouble shoot the CAN modules when running in real-time.
	The Stop Alarm soft-key. Press this to mute an alarm.
	Allows the GPS coordinates to be viewed as Latitude / Longitude or UTM (North / East)

Mapper Tools

The primary task performed in the Map page is object mapping. In Mapper, objects include points, polylines, or polygons. As explained before, you can pre-define some point and hazard objects in the Road maker setup. Each pre-defined object has a corresponding soft-key in the Map page. Mapping objects are also accessed via the Map Objects soft-key. Pressing this soft-key activates a menu containing all graphical object types. Each mapper tool selected will prompt the operator for an object name. The object name is the label for the item being mapped (See “Creating Object Name” on page 6-9.) Each object type is described in Table 6-4.

To select an object, use the up and down arrow keys on the legacy 6000 to highlight the desired object. Press the Enter key.

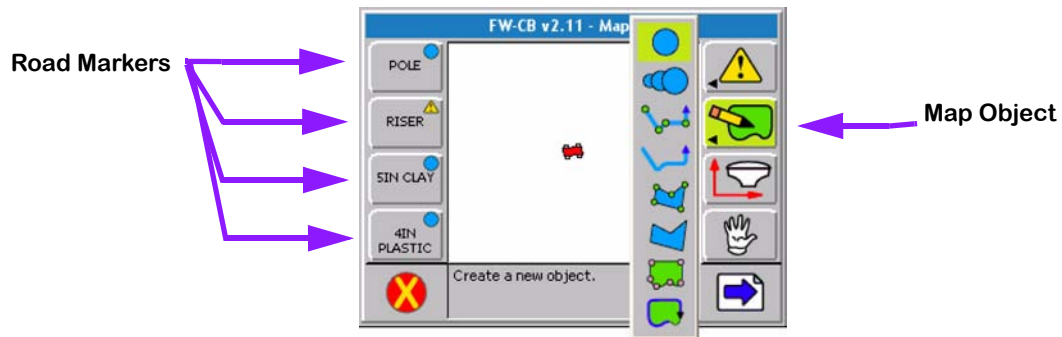

Figure 6-12: The Mapper Map Page

Object	Description
	Point-Mark. Maps a single point to the Map file. The Map Object soft-key changes to a Point soft-key. Press to mark a point. A prompt asks for a point name each time a point is marked.
	Point-Stream. Maps a stream of points at the data collection interval rate. The Map Object soft-key changes to the Points Stream soft-key. Press to turn stream on and off. A prompt asks for an object name.
	Polyline-Mark. Use to map or locate features that can be represented by a line of discrete points. The Map Object soft-key changes to the Polyline-Mark soft-key. Press to mark a point along the polyline. A prompt asks for an object name.
	Polyline-Stream. Use to map or locate features that can be represented by a line streaming points. The Map Object soft-key changes to the Polyline-Stream soft-key. Press to turn streaming on and off. A prompt asks for an object name.

Table 6-4: Mapping Object Description





Object	Description
	<p>Polygon-Mark. Use to map or locate features that can be represented by a closed shape made up of discrete points. The Map Object soft-key changes to the Polygon-Mark soft-key. Press to mark a point along the polygon perimeter. A prompt asks for an object name.</p>
	<p>Polygon-Stream. Use to map or locate features that can be represented by a closed shape made up of streaming points. The Map Object soft-key changes to the Polygon-Stream soft-key. Press to turn streaming on and off. A prompt asks for an object name.</p>
	<p>Mark Boundary Polygon - Use to map the perimeter and obtain the area of a feature by a closed shape made up of discrete points. This file is saved as a boundary file (BND) and can be used in an ARM application as the Boundary File.</p>
	<p>Streamed Boundary Polygon - Use to map the perimeter and obtain the area of a feature by a closed shape made up of streaming points. This file is saved as a boundary file (BND) and can be used in an ARM application as the Boundary File.</p>

Table 6-4: Mapping Object Description

The Options Menu

In the Map Page is an Options soft-key (Swiss Army Knife). Pressing the Options soft-key “pops-up” a small menu window on the Map page (Figure 6-13). The options menu contains several mapping aides and tools that can be used without exiting out of the real-time process. All items in the Option menu are toggle type; the item is set to either on or off. To activate an Option item, simply arrow down to the item and press enter. Pressing enter switches the state of the Option item. For example, if the item was on, it is switched to off. Table 6-5 describes each Options menu item.

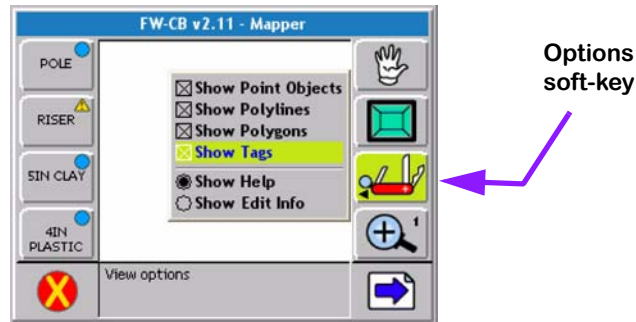

Figure 6-13: The Options Menu

Option	Description
Data Zoom	When activated, the map page uses collected data, not the background map, as its Zoom extents.
Show Base Map	When activated, the base map file is displayed in the background. When turned off the base map file is not displayed.
Show Point Objects	When activated, all point objects, contained in the Map file (GMF) named in Mapper setup, are displayed in the Map page.
Show Polylines	When activated, all polylines, contained in the Map file (GMF) named in Mapper setup, are displayed in the Map page.
Show Polygons	When activated, all polygons, contained in the Map file (GMF) named in Mapper setup, are displayed in the Map page.
Show Tags	All mapping objects have an associated tag, which contains the mapping object type and some associated attributes. When this item is activated, a tag is shown with each mapping object. This is useful if it is necessary to see the attributes of a particular object.
Show Help	When activated, help information is displayed in the bottom half of the map page. The help text corresponds to the highlighted soft-key.
Show Edit Info	When activated, attribute information for the nearest map object is displayed in the bottom half of the Map page.

Table 6-5: Options Menu Description

Exiting Real-Time Operation



To exit real-time operation, press the Exit button, located on the bottom left corner of the current page. When data is being stored to the PC card, the exiting process may take a minute or so to properly store this data.

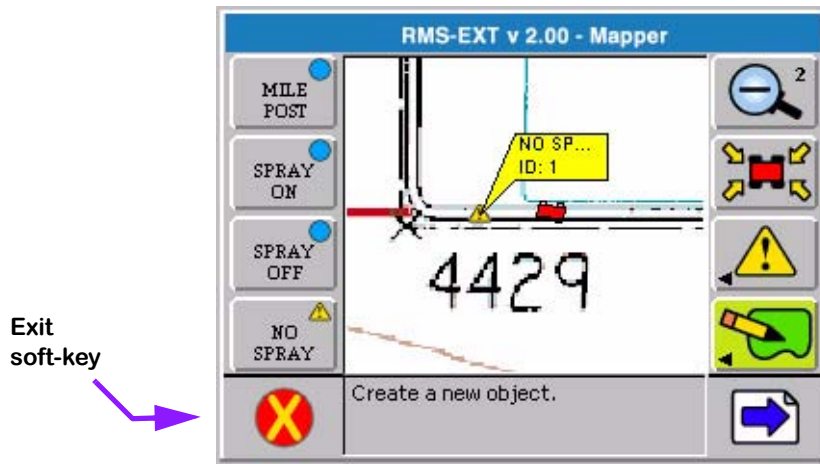

Figure 6-14: Exiting Real-time Application

Map Manager

Some Legacy 6000 system kits include Fieldware Tools. This program can be used to view application “as-applied” and “mapper” maps. To view “as-applied” and “mapper” maps, copy the record files (RCD) and Map files (GMF) from the PC card to a desktop or laptop computer. Consult the Map Manager user’s guide for instructions on how to generate application reports from the data.

Chapter Notes

Appendix A - PCM Favorites Settings

LIQFLOW-A

Favorite:	LIQFLOW-A
Application	Liquid
Application name	MAIN_TANK
Configuration	Standard
PCM link	None
Drive Type	Servo
Gain	3
Start Up Drive	20%
Master Switch	Hold
Implement Status	Close
Valve Delay	1.00s
Valve Location	In-Line
Units	gal/ac
Control Basis	Area
Primary Sensor	Flowmeter
Input	A
Sensor Name	FLOWMETER
Calibration #	153.1 pul/gal
Cal# Basis	NONE
Secondary Sensor	None
Monitor 1	Pressure Analog
Input	F
Sensor Name	PRESSURE_SENSOR
Alarm Units	psi
Min. Alarm	15
Max. Alarm	60
Alarm Delay	3s
Sensor Output	0-5.0v
Monitor 2	None
Monitor 3	None
Montior 4	None

GRANSERVO-A

Favorite:	GRANSERVO-A
Application	Granular
Application name	MAIN_BIN
Configuration	Standard
PCM link	None
Drive Type	Servo
Gain	3
Start Up Drive	20%
Master Switch	Close
Implement Status	Close
Valve Delay	1.00s
Valve Location	In-Line
Units	lb/ac
Control Basis	Area
Primary Sensor	Granular
Input	A
Sensor Name	CONVEYOR_SENSOR
Calibration #	400 pul/ft3
Cal# Basis	NONE
Secondary Sensor	None
Monitor 1	Shaft
Input	D
Sensor Name	SPINNER SPEED
Calibration #	2.0 pul/r
Alarm units	rpm
Min. Alarm	Off
Max. Alarm	Off
Alarm Delay	10s
Monitor 2	None
Monitor 3	None
Montior 4	None

GRANSERVO-B

Favorite:	GRANSERVO-A
Application	Granular
Application name	MAIN_BIN
Configuration	Standard
PCM link	None
Drive Type	Servo
Gain	3
Start Up Drive	20%
Master Switch	Close
Implement Status	Close
Valve Delay	1.00s
Valve Location	In-Line
Units	lb/ac
Control Basis	Area
Primary Sensor	Granular
Input	A
Sensor Name	CONVEYOR_SENSOR
Calibration #	368.2 pul/ft3
Cal# Basis	NONE
Secondary Sensor	None
Monitor 1	None
Monitor 2	None
Monitor 3	None
Montior 4	None

GRANPWM-A

Favorite:	GRANPWM-A
Application	Granular
Application name	MAIN_BIN
Configuration	Split Drive
PCM link	None
Drive Type	PWM
Gain	1
Frequency	120Hz%
Min.Duty Cycle	23%
Max. Duty Cycle	77%
Ramp Time	4 s
Dither	5%
Master Switch	Close
Implement Status	Close
Valve Delay	1.00 s
Units	lb/ac
Control Basis	Area
Primary Sensor	Granular
Input	A
Sensor Name	CONVEYOR_SENSOR
Calibration #	717.5 pul/ft3
Cal# Basis	NONE
Secondary Sensor	Granular
Input	B
Sensor Name	CONVEYOR_SENSOR
Calibration #	750.0 pul/ft3
Dual Warning %	10%
Dual Warning Delay	10 s
Monitor 1	Low Bin
Input	C
Sensor Name	LOW_BIN_LEFT
Alarm Status	High
Alarm Delay	5 s
Monitor 2	Low Bin
Input	D
Sensor Name	LOW_BIN_RIGHT
Alarm Status	High
Alarm Delay	5 s
Monitor 3	
Monitor 4	

GRANDC-A

Favorite:	GRANDC-A
Application	Granular
Application name	GRANULAR_MICRO
Configuration	Split Drive
PCM link	None
Drive Type	DC Motor
Units	lb/ac
Control Basis	Area
Primary Sensor	Granular
Input	A
Sensor Name	MICRO_BIN_SENSOR
Calibration #	1250.0 pul/ft3
Cal# Basis	NONE
Secondary Sensor	None
Monitor 1	Low Bin
Input	B
Sensor Name	LOW_BIN_LEFT
Alarm Status	High
Alarm Delay	5 s
Monitor 2	Low Bin
Input	C
Sensor Name	LOW_BIN_RIGHT
Alarm Status	High
Alarm Delay	5 s
Monitor 3	Shaft
Input	D
Sensor Name	FAN_RPM
Calibration #	2.0 pul/r
Alarm units	rpm
Min. Alarm	Off
Max. Alarm	Off
Alarm Delay	10s
Monitor 4	None

SPINMOTOR-A

Favorite:	SPINMOTOR-A
Application	Motor
Application name	SPINNERS
Configuration	Standard
PCM link	None
Drive Type	Servo
Gain	3
Start Up Drive	20%
Master Switch	Hold
Implement Status	Close
Valve Delay	1.00s
Valve Location	In-Line
Units	rpm
Control Basis	Time
Primary Sensor	Shaft
Input	A
Sensor Name	SPINNER_SENSOR
Calibration #	3 pul/ft3
Cal# Basis	NONE
Alarm units	rpm
Min. Alarm	500
Max. Alarm	1000
Alarm Delay	5 s
Secondary Sensor	None
Monitor 1	None
Monitor 2	None
Monitor 3	None
Montior 4	None

INJ-A

Favorite:	INJ-A
Application	Liquid
Application name	INJECTION_PUMP
Configuration	Standard
PCM link	None
Drive Type	Injection
Units	fl oz/ac
Control Basis	Area
Primary Sensor	Injection
Input	A
Sensor Name	INJECTION_PUMP
Calibration #	6.67 pul/fl oz
Cal# Basis	NONE
Secondary Sensor	None
Monitor 1	Product Detect
Input	C
Sensor Name	PUMP_N_FLOW_SENSOR
Alarm Status	Low
Alarm Delay	5 s
Monitor 2	None
Monitor 3	None
Monitor 4	None

Appendix B - Creating a Calibration Table

A Calibration Table can be created two way, Midwest Technologies recommends the table be created on a PC and loaded on the Legacy. The second option is to create the table Using the Legacy 6000. A Calibration Table allows the operator to select from a predefined set of calibration #'s that are commonly used. An example would be a granular application in which the gate height changes frequently resulting in the change of the calibration #. The instructions below will use a gate height Calibration Table as an example.

Creating a Calibration Table on a PC

Create a calibration table with a text editor such as NOTEPAD and save the file as “**CALS.TXT**” in folder labeled “**SYS**” on PC Card for the Legacy 6000.

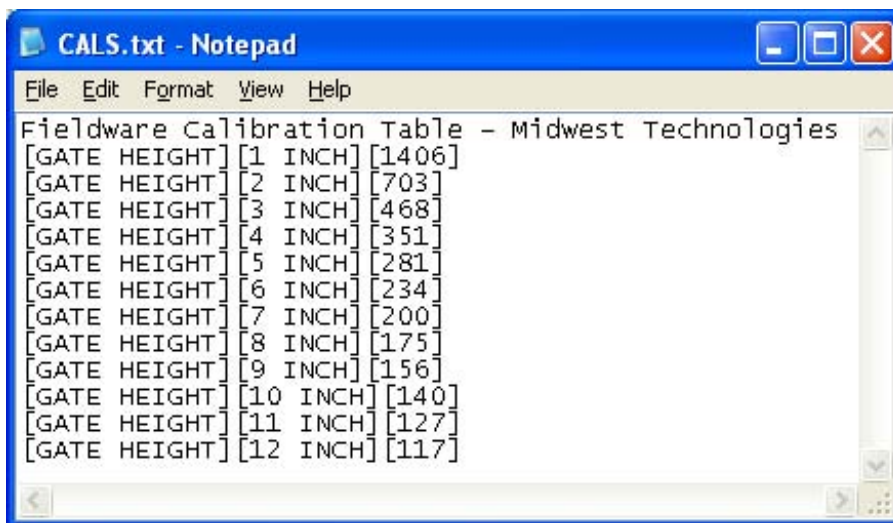
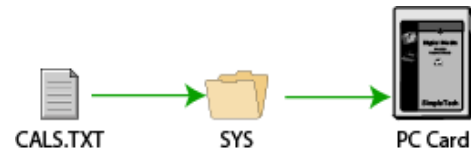

Here shown is a calibration table providing nominal calibration numbers for a granular system that employs Gate Height ranging from 1 to 12 inches. A valid entry **must** have three fields separated by square brackets within the bracket there **must** be some text [GATE HEIGHT][1 INCH][1406]. The Calibration Identifier will be the table name or label when loading the table in the Legacy 6000. Cal # Definition defines the calibration # related to it. The calibration number **must** be greater than zero and the units must relate to those selected in PCM Sensor Setup on the Legacy 6000. For example; if the sensor units are lbs/ac the Cal Table calibration #'s must be pul/lb.

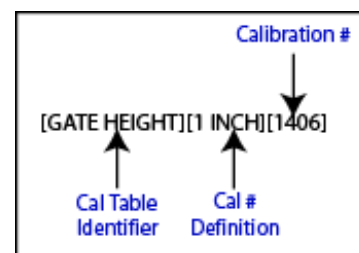

Fieldware for The Legacy 6000

Software Version 2.11

Loading Calibration Table in Legacy 6000

Loading the Calibration Table can be done in Five simple steps. With the console off place the PC Card in the Legacy 6000 and power the console on.



1. From the Main launcher page select the View Systems Tools button (wrench and ruler).



2. Select Device Manager from the system tools page.



3. From the device manager page select the Console device. Use the Up and Down arrows to scroll through the devices in the middle of the screen.



4. Locate and select the Update Console Using System Files button. This button will be the PC Card with a green arrow pointing to the left.



5. From the Update Files page use the Up and Down arrows to locate Cal Table in the middle of the screen. Once Cal Table has been located press the Update Console button (PC Card with green arrow pointing to the left). Once pressed an information bar will appear stating the console is being updated, when this bar is gone the console has been updated and the Cal Table has been loaded on the Legacy 6000.

Using the Calibration Table

To implement the Calibration table the table must be activated during PCM Primary Sensor setup. Once activated the Cal# can be changed in Product setup before any application. Midwest Technologies recommends that each Cal Table setting be calibrated using the calibration procedure from the ARM Launcher page.

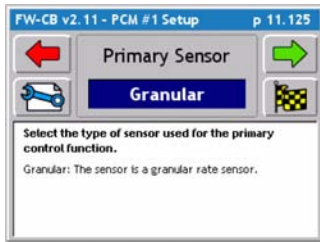

1. Enter PCM Setup and navigate through PCM setup to Primary Sensor. Select the Tools Button from the Primary Sensor page.



2. Use the Down arrow to highlight Cal# Basis and Press the Enter button.

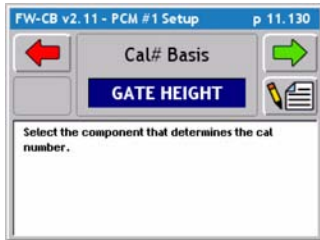

3. Select the Cal Table to be used. The Name of the Cal Table is the Cal Table Identifier (The first column in the brackets when creating the Cal Table). After the Cal# Basis has been selected continue forward through PCM setup and **Apply the Settings**. The Cal Table is now ready for use.



4. To use the Cal Table enter Product setup from the ARM Launcher page.

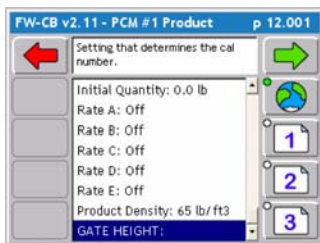

5. Use the Down arrow to highlight GATE HEIGHT (This name is dependent on the Cal Table Identifier) and press the enter button. Select the desired gate height or calibration# description. This selection will automatically change the Cal# in the system.

Creating a Calibration Table Using the Legacy 6000

- From PCM Setup navigate to the Primary Sensor page and select the tools button.
- Use the Down arrow to highlight Cal# Basis and press enter.
- Name the Cal# Basis, this will be the Name of the Cal Table. Once a name has been established continue forward through PCM Setup and apply the settings.
- Advance to the ARM Launcher page and select the Calibration button. Choose the calibration procedure for the application and press the green forward arrow.
- Because Cal# Basis is not NONE in PCM Setup, a new screen appears in calibration. This screen will have the same name that was entered for Cal# Basis in PCM Setup. From this screen name a parameter to be calibrated. In the example above GATE HEIGHT was the Cal Table name and each parameter was described in inches (1 INCH, 2 INCH, ...etc.)
- Proceed through calibration, once calibrated name the next parameter in the Cal Table and Calibrate. Repeat this step for each Cal Table parameter.

NOTE: If GATE HEIGHT is used for the Cal# Basis name in PCM Setup, Midwest Technologies has pre-named the parameters in Calibration 1 INCH - 12 INCH.

Appendix C - NH3 Application

When using the NH3 mode review the settings below to ensure the Cal # and Density have been entered correctly. The Cal # is located in PCM setup under Primary Sensor Tools. The Density value is accessed from the ARM launcher page in Product Setup.

NH3 Application Cal#

For **All** NH3 applications the Cal # units should be entered in **Pulses / Gallon**. The Cal # units **DO NOT** change even if the displayed units are in (lbs. of NH3 / acre) or (lbs. Actual N / acre).

Density for NH3 and Actual N

Density will determine the units of the applied and displayed rate (lbs of NH3 / acre or lbs of actual N / acre) in real-time applications. If the operator wants to apply and display the rate in lbs of NH3 / acre, the operator would enter a density of lbs of NH3 / gal. If the operator wants to apply and display the rate in lbs of Actual N / acre, the operator would enter a density of lbs of Actual N / gal.

NOTE: Temperature affects the Density. Use the chart below to locate the correct value (Figure 1-1). Use the temperature or tank pressure column to determine the correct density.

Example:

Cal # - pulses / gal

Operator wants to enter and display pounds of actual N / acre. If the temperature is 65°F, density would be entered in Product Setup as 4.19 lbs of actual N / per gal.

Properties Of Liquid Ammonia At Various Temperatures

Temperature		Pressure		Liquid Density (lbs / gal of NH3)			
°F	°C	PSI	bar	NH3 lbs/gal	NH3 Kg/L	N lbs/gal	N Kg/L
0	-18	15.7	1.1	5.53	0.66	4.54	0.54
10	-12	23.8	1.6	5.47	0.66	4.49	0.54
20	-7	33.5	2.3	5.41	0.65	4.44	0.53
30	-1	45	3.1	5.34	0.64	4.37	0.53
40	4	58.6	4	5.28	0.63	4.33	0.52
50	10	74.5	5.1	5.21	0.63	4.27	0.52
60	16	92.9	6.1	5.15	0.62	4.22	0.51
65	18	103.1	7.1	5.11	0.61	4.19	0.5
70	21	114.1	7.9	5.08	0.61	4.17	0.5
75	24	125.8	8.7	5.04	0.6	4.13	0.49
80	27	138.3	9.5	5.01	0.6	4.11	0.49
85	29	151.7	10.5	4.97	0.6	4.08	0.49
90	32	165.9	11.4	4.94	0.59	4.05	0.48
95	35	181.1	12.5	4.9	0.59	4.02	0.48
100	38	197.2	13.6	4.87	0.58	3.99	0.47

Figure 1-1: Density Table

NH3 is 82% Actual N by weight

1gal NH3 @ 60°F = 5.15lbs x .82 = 4.22lbs of Actual N / 1 gal of NH3

Notes
