

SENTRY 6140

USER MANUAL

Tip Flow Monitor



A Subsidiary of  Spraying Systems Co.®

Copyrights

© 2014 TeeJet Technologies. All rights reserved. No part of this document or the computer programs described in it may be reproduced, copied, photocopied, translated, or reduced in any form or by any means, electronic or machine readable, recording or otherwise, without prior written consent from TeeJet Technologies.

Trademarks

Unless otherwise noted, all other brand or product names are trademarks or registered trademarks of their respective companies or organizations.

Limitation of Liability

TEEJET TECHNOLOGIES PROVIDES THIS MATERIAL "AS IS" WITHOUT WARRANTY OF ANY KIND, EITHER EXPRESSED OR IMPLIED. NO COPYRIGHT LIABILITY OR PATENT IS ASSUMED. IN NO EVENT SHALL TEEJET TECHNOLOGIES BE LIABLE FOR ANY LOSS OF BUSINESS, LOSS OF PROFIT, LOSS OF USE OR DATA, INTERRUPTION OF BUSINESS, OR FOR INDIRECT, SPECIAL, INCIDENTAL, OR CONSEQUENTIAL DAMAGES OF ANY KIND, EVEN IF TEEJET TECHNOLOGIES HAS BEEN ADVISED OF SUCH DAMAGES ARISING FROM TEEJET TECHNOLOGIES SOFTWARE.



Safety Information

TeeJet Technologies is not responsible for damage or physical harm caused by failure to adhere to the following safety requirements.

As the operator of the vehicle, you are responsible for its safe operation.

The Sentry 6140 is not designed to replace the vehicle's operator.

The Sentry 6140 is designed to support and improve efficiency while working in the field. The driver has full responsibility for the quality and work related results.

Photos and illustrations may vary from the actual components provided. This may be due to different installation options, operation modes or production models.

Always try to use original parts. Built to the highest standards of safety and reliability, TeeJet Technologies parts are to be used for this system as others might jeopardize the safety and function of the system. TeeJet is not responsible for any redesign or adaptations of the Sentry 6140. Any changes to the Sentry 6140 voids the company warranty.

Table of Contents

COMPONENTS	2
Boom Interface Module Harness Connection.....	5
SYSTEM COMPONENTS	6
Sentry 6140 Console.....	6
Nozzle Body with Flow Meter and Tip Sensor Interface	6
Flow Meter Assembly.....	7
Kit Assembly	7
POWER	8
SETUP	9
Display Brightness.....	10
Master Sound.....	10
Tip Alarm Percentage.....	10
Tip Alarm Delay	10
Number of Sections	11
Number of Tips per Section	11
Boom Section On/Off Beep.....	11
TIP BALANCE	12
OPERATION	13
On Screen Indicators.....	13
System Errors.....	13

Sentry 6140 Tip Flow Monitor

COMPONENTS

Unpack the installation kit and identify the required parts for your installation.

Item	Part Number	Description	Quantity
A	75-30100	Sentry 6140 Console	1
B	78-05101	Tip Flow Monitor Interface (TFMI).....	1
C	45-10148	Tip Flow Monitor Interface (TFMI) Harness	1
D	78-05091	Boom Interface Module (BIM).....	1
E	45-10142*	Boom Interface Module (BIM) Harness	1
F	varies	Harness to Tip Sensor Interface Extension Cable	varies
		45-05857: 3'/1 m, 45-05858: 6'/1.8 m, 45-05859: 12'/3.6 m, 45-05864: 35'/10.7 m	
G	varies	Console to TFMI Harness Extension Cable.....	varies
		45-05900: 5'/1.5 m, 45-05901: 10'/3 m, 45-05902: 20'/6 m, 45-05903: 40'/12 m	
H	78-05104	Tip Sensor Interface.....	varies
I	78-05105	Dual Tip Sensor Interface	varies
J	57-00122	Nozzle Flow Meter	varies
K	45-05856	Terminator, End (Male)	1
L	45-05855	Terminator, Start (Female).....	1

*Actual harness may be machine specific.

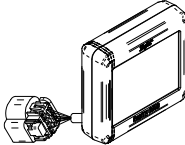
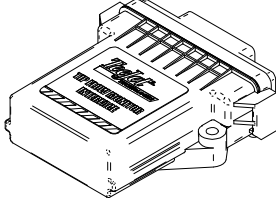
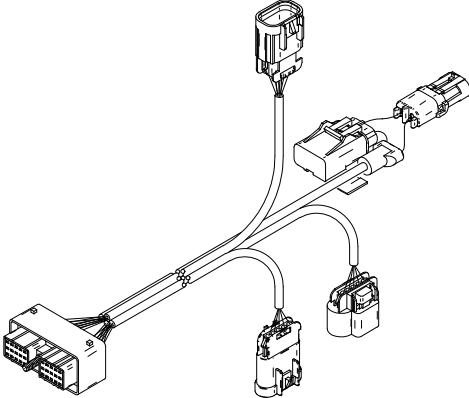
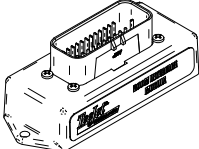
Item	Part #	Description	Illustration
A	75-30100	Sentry 6140 Console	
B	78-05101	Tip Flow Monitor Interface (TFMI)	
C	45-10148	Tip Flow Monitor Interface (TFMI) Harness	
D	78-05091	Boom Interface Module (BIM)	

Sentry 6140 Tip Flow Monitor

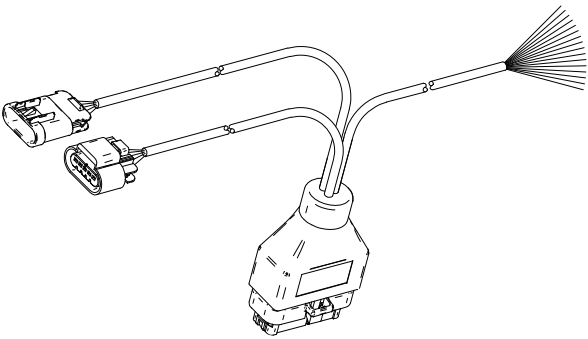
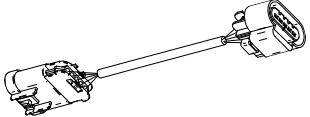
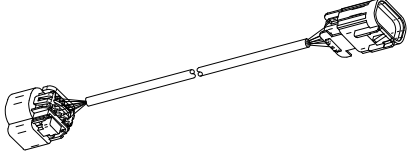
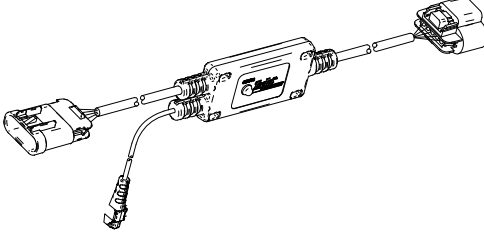
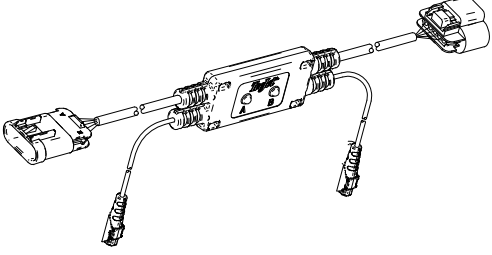
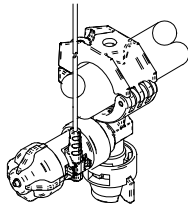
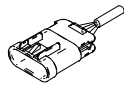
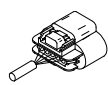
Item	Part #	Description	Illustration
E	45-10142	Boom Interface Module (BIM) Harness (Actual harness may be machine specific.)	
F	45-05857: 3'/1 m, 45-05858: 6'/1.8 m, 45-05859: 12'/3.6 m, 45-05864: 35'/10.7 m	Harness to Tip Sensor Interface Extension Cable	
F	45-05900: 5'/1.5 m, 45-05901: 10'/3 m, 45-05902: 20'/6 m, 45-05903: 40'/12 m	Console to TFMI Harness Extension Cable	
G	78-05104	Tip Sensor Interface	
H	78-05105	Dual Tip Sensor Interface	
I	57-00122	Nozzle Flow Meter	
J	45-05856	Terminator, End (Male)	
K	45-05855	Terminator, Start (Female)	

Sentry 6140 Tip Flow Monitor

Figure 1: System Diagram

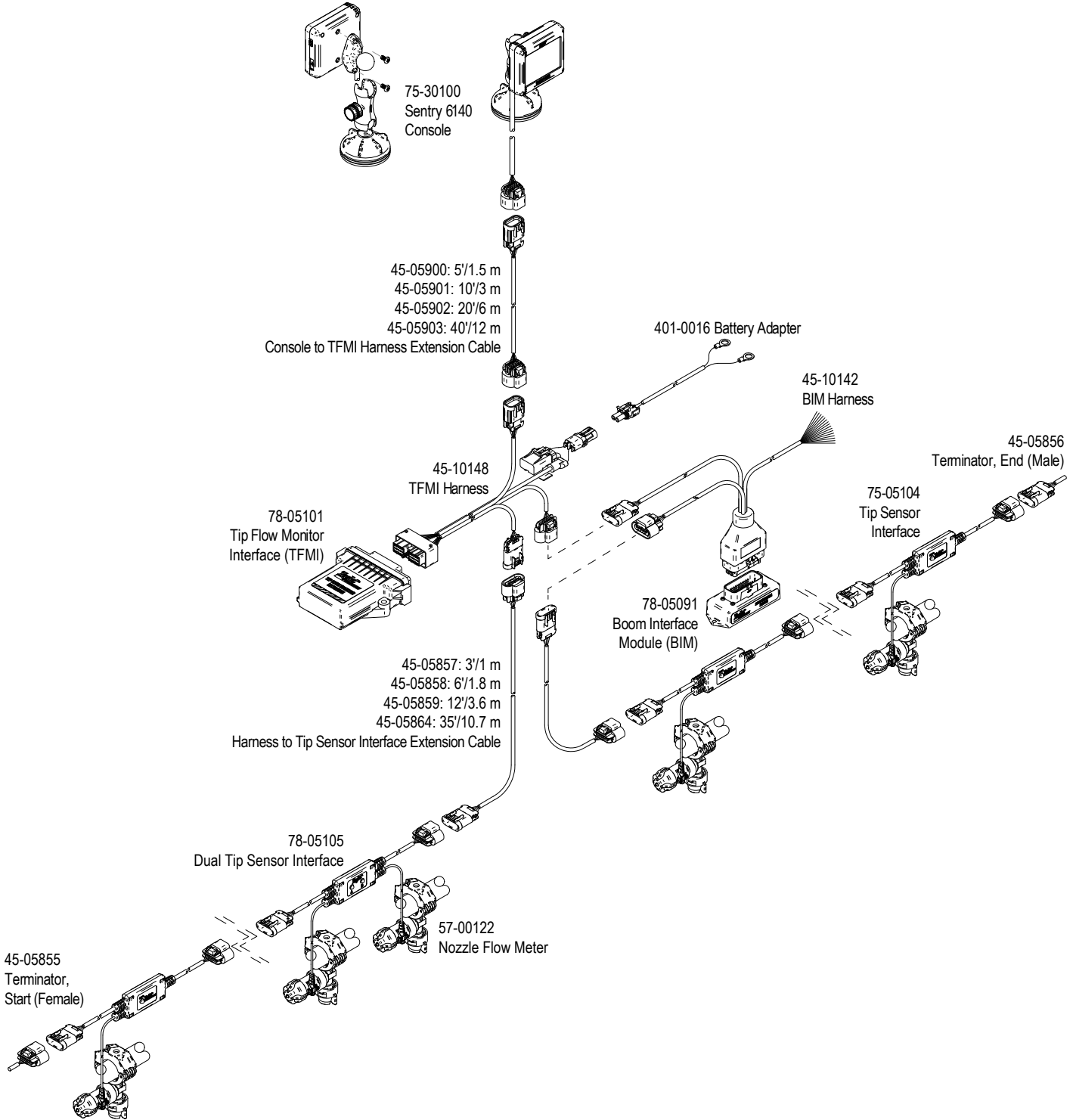

Section 1

The sections are numbered from left to right while standing at the back of the machine and begin at the Start Terminator.

Boom Interface Module Harness Connection

With each machine having a different possible switchbox configuration, it is impossible to specify the exact location to T-Tap into the valve harness. However, the following guidelines may provide some assistance in completing the installation.

1. Identify boom section cable that runs from the Boom Switchbox to the boom valves.
2. Use a T-Tap (or similar product) to connect into the signal wire.

NOTE: In some cases, the Boom Interface Module Harness wires can be connected directly to the switches inside the Switchbox using the proper spade terminal.

3. Repeat this process for each individual boom section.

Figure 2: Boom Interface Module Harness Connection

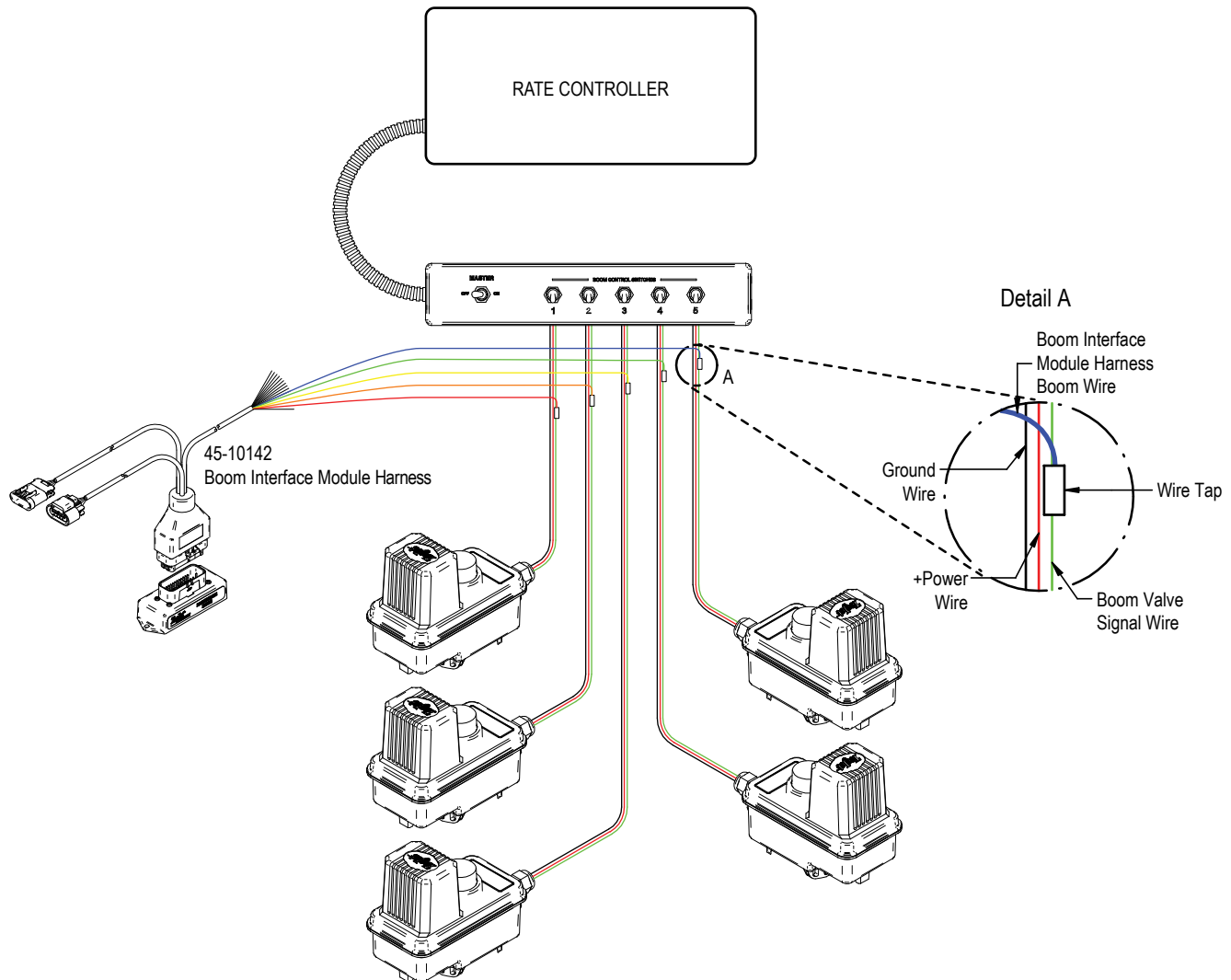

Sentry 6140 Tip Flow Monitor

SYSTEM COMPONENTS



If there are questions concerning the installation of the Sentry 6140 system on this vehicle, or due to the changes in component specifications the parts supplied in the kit are not exactly as presented in this document, please contact your dealer or TeeJet Customer service representative for clarification before installation. TeeJet Technologies is not responsible for misuse or incorrect installation of the system.

Sentry 6140 Console

The Sentry 6140 Console is designed to provide years of service under typical agricultural operating conditions. A tight fitting enclosure means that typical dusty environments will not cause operational problems. While occasional splashing of water will not damage the unit, the Sentry 6140 Console is not designed for direct exposure to rain. Take care not to operate the Sentry 6140 Console in wet conditions.

Figure 3: Sentry 6140 Console Front and Back



Nozzle Body with Flow Meter and Tip Sensor Interface

The turbine style flow meter used with the Sentry 6140 Tip Flow Monitor is compact, reliable and proven. The threaded connection allows the sensor to be added onto a wide range of standard TeeJet single and multiple outlet nozzle bodies. ChemSaver® diaphragm check valves remain in place allowing for positive spray tip shutoff. Ample clearance inside the flow meter means minimal flow restriction and generous free passage for particles contained in the spray solution. Long wearing materials are used in bearing surfaces to ensure a consistent flow reading and the flow meter sensor is mounted externally to prevent any direct contact with the spray solution for long-term reliability.

Figure 4: Flow Monitor Assembly

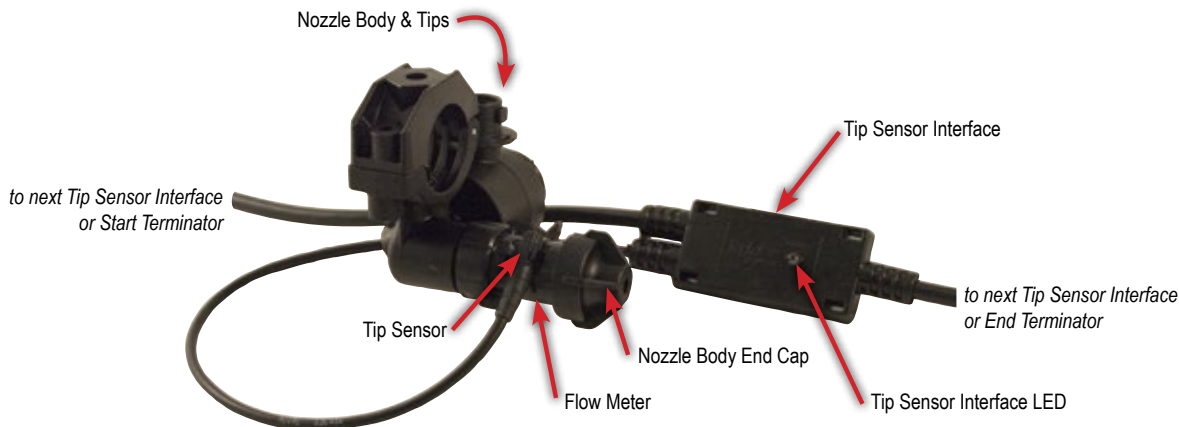

Flow Meter Assembly

The flow meter gasket has two different sides. The side with the larger center is to be inserted towards the sensor or inside the flow meter.

Figure 5: Flow Meter and Gasket

Flow Meter



Figure 6: Gasket Detail



Kit Assembly

1. Remove end cap from nozzle body.
2. Attach end cap to flow meter (J).
3. Attach flow meter to nozzle body. Hand tighten.
4. Loosely secure Tip Sensor Interface (H or I) close to nozzle body / flow meter assembly. Cable ties (not included) can be threaded through Tip Sensor Interface slots.
5. Push sensor of Tip Sensor Interface into slot on flowmeter. Clips on flow meter should be in the groves on the center of the sensor.
6. Secure Tip Sensor Interface.
7. Connect Start Terminator (L) to section 1 Tip Sensor Interface.
8. Connect each Tip Sensor Interface moving from left to right (while standing at the back of the machine).
 - ▶ Extension cables from Boom Interface Module Harness (E) and Tip Flow Monitor Interface Harness (C) will connect between two Tip Sensor Interfaces.
9. Connect End Terminator (K) to the last section's Tip Sensor Interface.

Figure 7: Nozzle Body with Flow Meter Assembly



Figure 8: Sensor & Clips

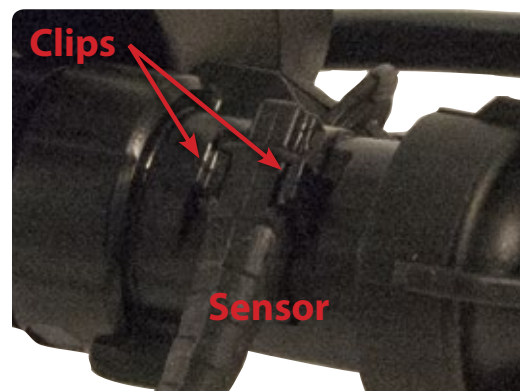
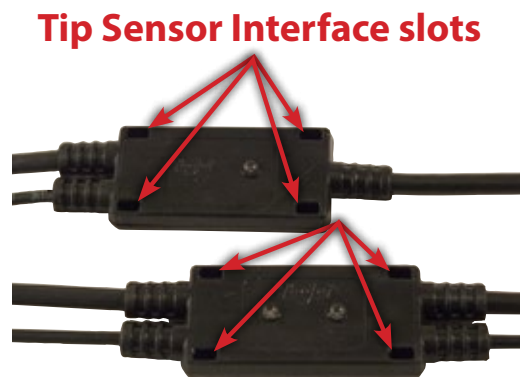

Figure 9: Tip Sensor Interface Slots



Sentry 6140 Tip Flow Monitor

POWER

Slide the POWER SWITCH  to power on or off the console.

On power up the console detects the number of Tip Sensor Interfaces (TSI) (**H or I**) on the boom and displays the status of the sensors and the system. The LED's on each TSI are turned on and go off as each is detected and given their unique address.

The addresses start at #1 and continue across the boom. Tips are numbered from left to right while standing in the forward facing direction of the machine and begin at the Start Terminator.

- ▶ Sensor connected to the Start Terminator [female] (**L**) on the left side of the machine will be #1
- ▶ Sensor connected to the End Terminator [male] (**K**) on the right side of the machine will be the last sensor.

The Status Box displays if all tips are OK or if any errors are found.

Figure 10: Splash Screen

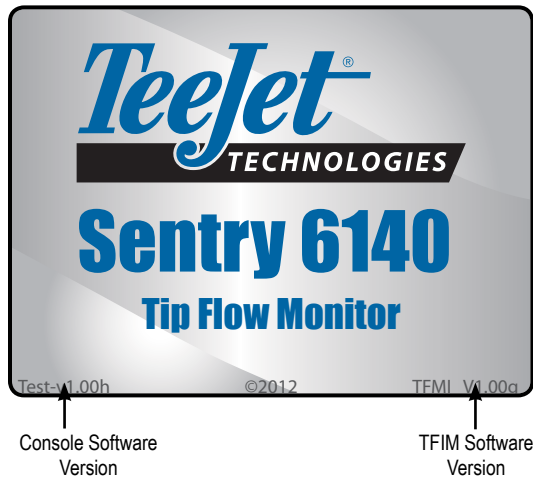

Figure 11: Tip Sensor Interface LEDs

Single Tip Sensor Interface



Dual Tip Sensor Interface



Figure 12: Home Screen

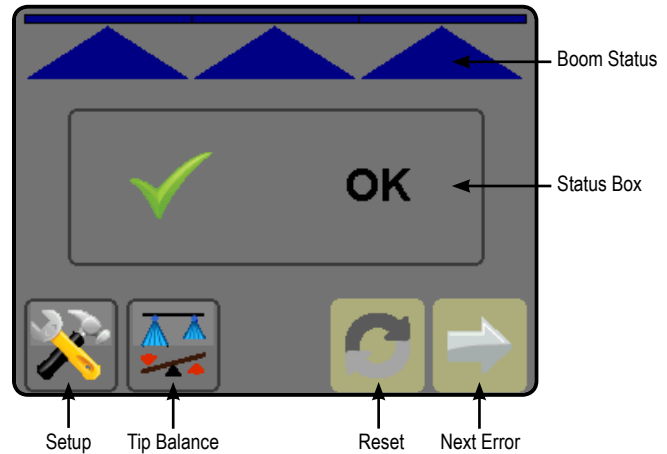

NOTE: Screen options may vary depending on enabled or disabled functions as well as function availability.

The Balance button will be unavailable or grayed out  if all boom sections and the master switch are not on.

SETUP

 If there are questions concerning the setup of the Sentry 6140, please contact your dealer or TeeJet Customer service representative for clarification before operation. TeeJet Technologies is not responsible for misuse or incorrect operation of the system.

Setup is used to configure Display Brightness, Master Sound, Tip Alarm Percentage, Tip Alarm Delay, Number of Sections, Number of Tips per Section and Boom Section On/Off Beep.

Figure 13: Setup Button on Home Screen

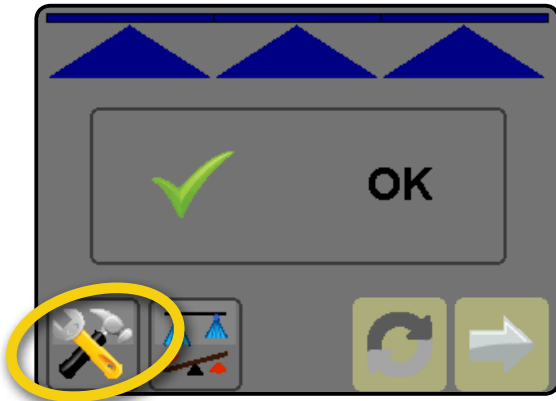

Figure 14: Buttons on Setup Screens

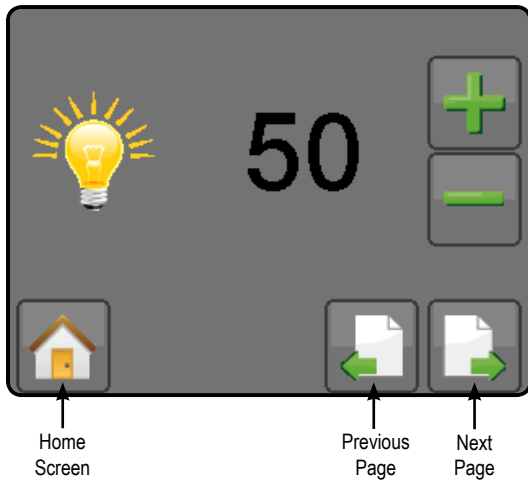



Figure 15: Setup Screen Order

- ◀ Display Brightness – Sets the brightness level of the display
- ◀ Master Sound – Enable/disable console sound
- ◀ Tip Alarm Percentage – Sets the error reporting range for the tip sensors
- ◀ Tip Alarm Delay – Sets the time the console will wait after an error has been encountered before sounding a tip alarm
- ◀ Number of Sections – Sets the number of boom sections
- ◀ Number of Tips per Section – Enters the number of tips on each boom section
- ◀ Boom Section On/Off Beep – Enable/disable beep when a boom section is turned on or off

Sentry 6140 Tip Flow Monitor

Display Brightness

 Sets the brightness level of the display. Range is 5% to 100% in 5% increments.







1. Press the MINUS/PLUS buttons   to adjust the brightness.
2. Press
 - ▶ NEXT PAGE button  to proceed to Master Sound.
 - ▶ PREVIOUS PAGE button  to go back to Boom Section On/Off Beep.

Figure 16: Display Brightness

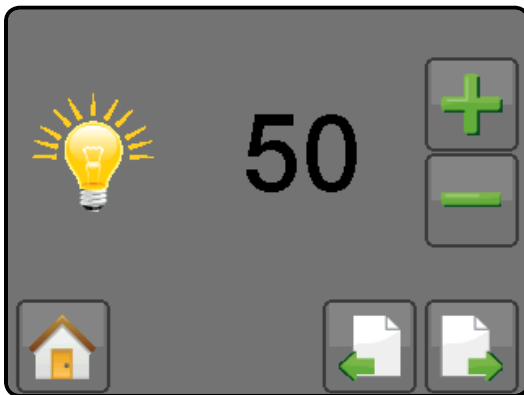

Master Sound

 Enable/disable console sound.







1. Press the UP/DOWN buttons   to toggle the sound on or off.
2. Press
 - ▶ NEXT PAGE button  to proceed to Tip Alarm Percentage.
 - ▶ PREVIOUS PAGE button  to go back to Display Brightness.

Figure 17: Master Sound

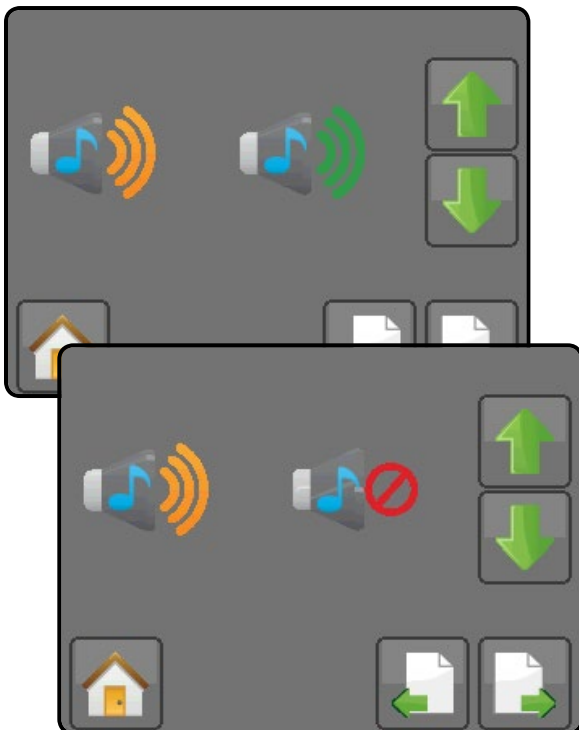

Tip Alarm Percentage

 Sets the error reporting range for the tip sensors. If the flow rate of an individual tip falls below, or rises above this range, the console will generate an alarm. The value entered is the percentage above and below the average flow that a tip must pass to trigger an alarm. Range is 0% to 100%.







1. Press the MINUS/PLUS buttons   to adjust the percentage.
2. Press
 - ▶ NEXT PAGE button  to proceed to Tip Alarm Delay.
 - ▶ PREVIOUS PAGE button  to go back to Master Sound.

Figure 18: Tip Alarm Percentage

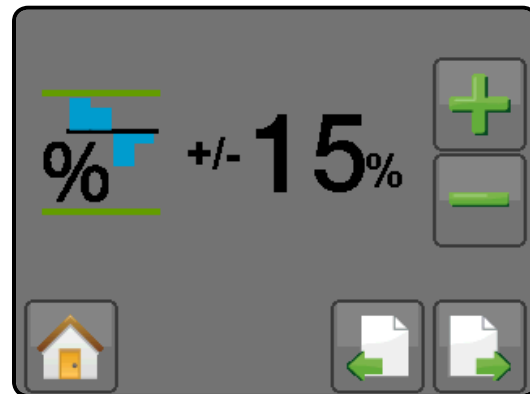

Tip Alarm Delay

 Sets the time the console will wait after an error has been encountered before sounding a tip alarm. If the error is corrected within this time, no alarm will sound or error will display on screen. The delay value is selectable from 1 to 10 seconds.







1. Press the MINUS/PLUS buttons   to adjust the time.
2. Press
 - ▶ NEXT PAGE button  to proceed to Number of Sections.
 - ▶ PREVIOUS PAGE button  to go back to Tip Alarm Percentage.

Figure 19: Tip Alarm Delay

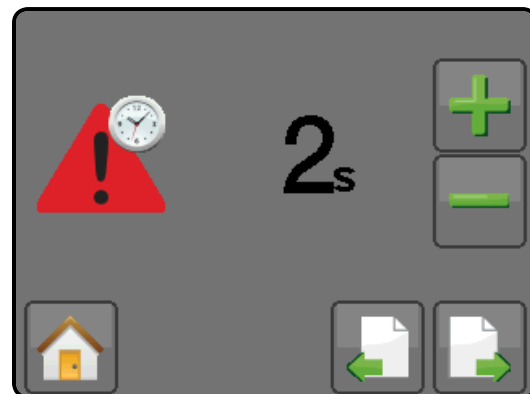

Number of Sections

 Select the number of boom sections. The sections are numbered  from left to right while standing in the forward facing direction of the machine and begin at the Start Terminator. Range is 1 to 15 sections.







1. Press the MINUS/PLUS buttons   to adjust the number of boom sections.
2. Press
 - ▶ NEXT PAGE button  to proceed to Number of Tips per Section.
 - ▶ PREVIOUS PAGE button  to go back to Tip Alarm Delay.

Figure 20: Number of Sections



Number of Tips per Section

   Enter the number of tips on each boom section. Sections are numbered from left to right while standing in the forward facing direction of the machine and begin at the Start Terminator. Range is 1 to 120 tips.









1. Press the MINUS/PLUS buttons   to set the number of tips per the current section.
2. At the boom section 1, press
 - ▶ PREVIOUS PAGE button  to go back to Number of Sections.
 - ▶ NEXT PAGE button  to cycle through all available boom sections.
3. At the last boom section, press
 - ▶ NEXT PAGE button  to proceed to Boom Section On/Off Beep.
 - ▶ PREVIOUS PAGE button  to go back to previous boom sections.

Figure 21: Tips per Section

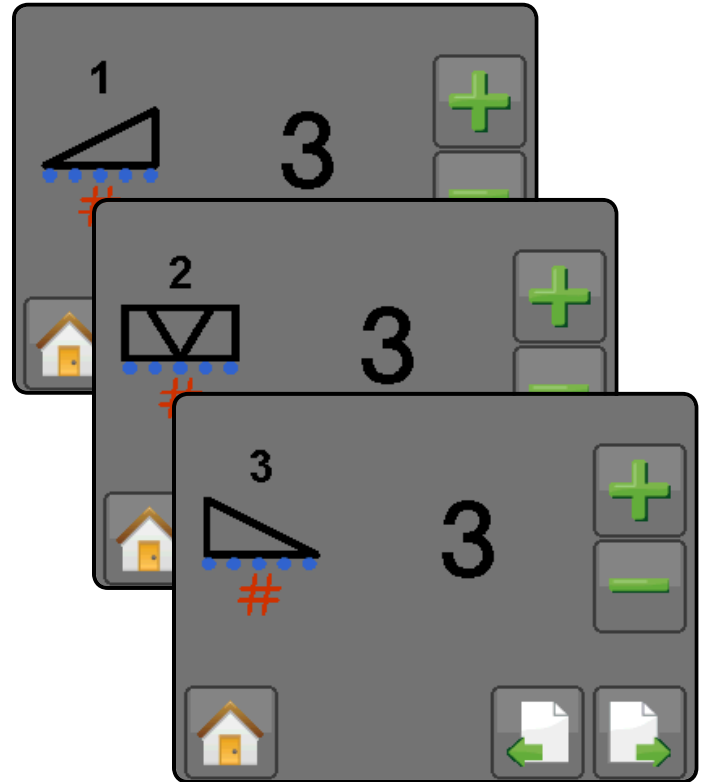

Boom Section On/Off Beep

 Enable/disable beep when a boom section is turned on or off. This feature is useful if a BoomPilot system frequently changes boom sections.





1. Press the UP/DOWN buttons   to toggle the mute function on or off.
2. Press
 - ▶ NEXT PAGE button  to proceed to Display Brightness.
 - ▶ PREVIOUS PAGE button  to go back to last boom section of the Number of Tips per Section setup.

Figure 22: Boom Section Beep – ON



Sentry 6140 Tip Flow Monitor

TIP BALANCE

 Balancing the tips is required for the system to compare and monitor individual tips. The system will scan all the tips to get the flow rate. The flow rate of each tip must be within the tip balance percentage range of the average flow rate in order to balance successfully. If any tip is outside this range, an error will be generated, and the user will need to inspect the tip.

NOTE: In order to maintain system accuracy, balancing the tips is required anytime a tip is changed.



The console will not be able to detect small flow changes until a tip balancing is completed successfully.

Tip Balance Percentage is OEM specified. Default balance is +/-15%.

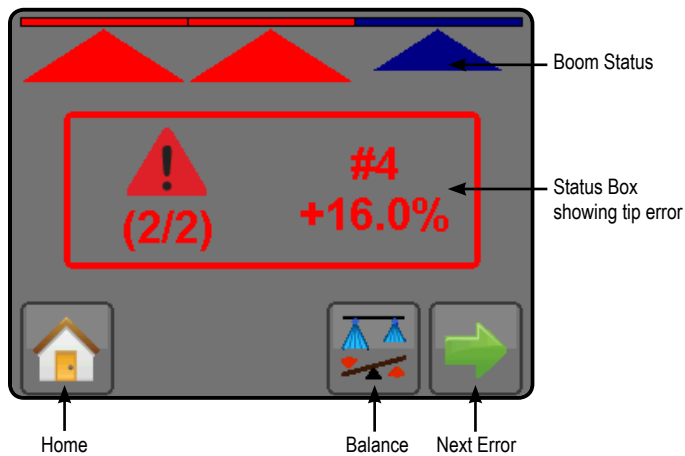
Figure 23: Tip Balance



To check if the tips are balanced:

1. Machine must be spraying at normal operation parameters.
2. Press BALANCE button  on the Home Screen.
3. Press BALANCE button  to start the balance check. The on-screen boom sections will flow on and off during this check.
4. If an error occurs, the Status Box and boom section will flash red. The Status Box show the tip or tips that are at fault including their percentage of error or N/C for "not connected". Inspect the tip(s) noted on the Status Box. The LED on the Tip Sensor Interface (**H or I**) will also be illuminated corresponding to the tip or tips that are at fault.

The NEXT ERROR button  is only enabled if more than one error is found when balancing the tips.

5. After correcting the problem, press BALANCE button  to start new balance check.

Figure 24: Tip Balance Process



OPERATION

After the tips are balanced, the user can enter Operation mode. The system will monitor all the tips and their the flow rate if their respective boom section is turned on. The flow rate of each tip must be within the percentage range (entered in the Setup mode). If any tip is outside this range, an error will be generated, and the user will need to inspect the tip that is at fault. The LED on the Tip Sensor Interface (**H or I**) will also be illuminated corresponding to the tip or tips that are at fault.

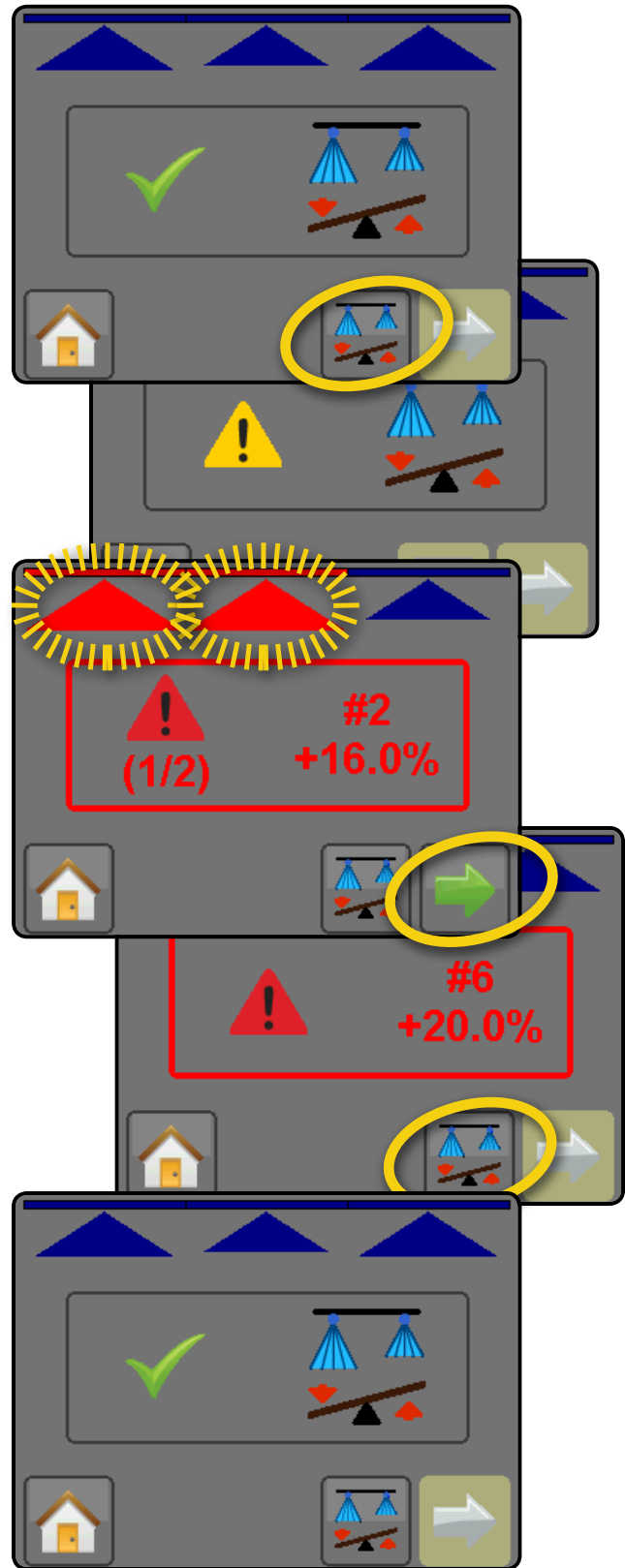
On Screen Indicators

Boom Sections

- ▶ Blue, spray shown – turned on
- ▶ Empty, no spray – turned off
- ▶ Red – a tip on that section has an error and needs to be inspected.

Status Box

- ▶ Green Check Mark – shows all tips are operating normally
- ▶ Red flashing – an error occurred,
 - Tip error – the Status Box will show the tip number(s) that is at fault with the percentage off or “N/C” when the specified tip is not connected.
 - System error – the Status Box will show an error code

Buttons



- ▶ Reset button  – inactive unless an error occurs. It is then enabled to run the system again after checking the tips.
- ▶ Next Error button  – only enabled if more than one error is found when operating. It allows the user to cycle through the list of tips that need to be checked.

Figure 25: Operation – All Tips OK



Figure 26: Operation – Tip Error



System Errors

The errors that prevent the console from going into normal operation are now displayed as error codes in the Status Box.

Error Codes:

- #1 - Number of tips or boom sections entered in setup mode does not match number of tips or boom sections detected
- #2 - Terminator (**K or L**) not detected
- #3 - Boom Interface Module (**E**) not detected
- #4 - Lost communication with Tip Flow Monitor Interface (TFMI) (**B**)

If any of these errors occur while in normal operation, the system will beep 3 times to alert that an error has occurred.

Figure 27: Operation – System Error



SENTRY 6140

USER MANUAL

Identifying Plugged Spray Tips Has Never Been Easier

Worn, plugged or partially blocked spray tips can have a significant impact on the quality of your spraying job. Streaks in the field caused by misapplication can result in yield reductions, increased weed pressure and the need to re-apply – all of which can be costly. The Sentry 6140 Tip Flow Monitor provides a simple, reliable solution to this age-old problem. Flow sensors, mounted at each spray tip location, precisely measure the flow passing through the tip and provide instantaneous feedback to the operator should a tip become clogged, lost, or a nozzle body unintentionally rotated to an incorrect position. By eliminating the need to detect plugged tips visually from the cab, operators can cover more acres in a day, and know, with confidence, that their spray tips are operating properly.



1801 Business Park Drive
Springfield, Illinois 62703 USA
www.teejet.com

A Subsidiary of  **Spraying Systems Co.**

98-05306-ENUS-LT R3 English-US
© TeeJet Technologies 2014