



## AIXR TEEJET<sup>®</sup>

### AIR INDUCTION XR FLAT SPRAY TIPS

The AIXR TeeJet Flat Spray Tip offers the benefits of obtaining excellent drift resistance without compromising spray coverage. The larger droplets produced by the AIXR make this tip ideal for a wide variety of systemic herbicides and applications where drift control is critical. The unique UHMWPE material used also makes this tip ideal for highly acidic applications, such as applying defoliation products.

#### AIXR Features and Benefits

- A perfect balance of drift control and coverage – precisely sized, large, air filled drops stay on target and cover the entire plant
- Wide operating pressure range of 15-90 PSI (1-6 bar) gives you fewer driftable droplets at higher pressures than most other tips
- Available in nine VisiFlo<sup>®</sup> tip capacities
- Unique UHMWPE polymer material provides significantly longer wear life and better acid resistance
- Air-induction design enhances coverage of larger droplets through air inclusion
- Compact design avoids damage
- Easy to remove pre-orifice for quick maintenance
- AIXR 015-06 capacities fit 114441-\*<sup>-</sup>CELR Quick TeeJet<sup>®</sup> cap and gasket
- AIXR 08-10 capacities fit 114443-\*<sup>-</sup>CELR Quick TeeJet cap and gasket
- For combined assembly of tip, cap and gasket order AIXR110\*\*VP-CE

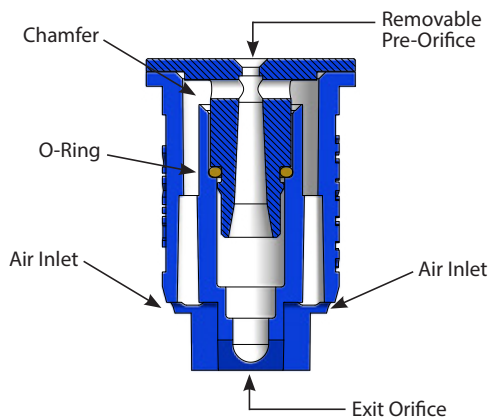

CROSS SECTION VIEW



AIXR TIP AND CAP



#### SELECTION GUIDE









CONTACT PRODUCT	SYSTEMIC PRODUCT	DRIFT MANAGEMENT
GOOD	EXCELLENT	EXCELLENT

# AIXR TEEJET® AIR INDUCTION XR FLAT SPRAY TIPS

## APPLICATION INFORMATION

		DROP SIZE	CAPACITY ONE NOZZLE IN l/min	l/ha 													
				4 km/h	5 km/h	6 km/h	7 km/h	8 km/h	10 km/h	12 km/h	16 km/h	18 km/h	20 km/h	25 km/h	30 km/h	35 km/h	
AIXR110015 (100)	1.0	XC	0.34	102	81.6	68.0	58.3	51.0	40.8	34.0	25.5	22.7	20.4	16.3	13.6	11.7	
	2.0	C	0.48	144	115	96.0	82.3	72.0	57.6	48.0	36.0	32.0	28.8	23.0	19.2	16.5	
	3.0	C	0.59	177	142	118	101	88.5	70.8	59.0	44.3	39.3	35.4	28.3	23.6	20.2	
	4.0	M	0.68	204	163	136	117	102	81.6	68.0	51.0	45.3	40.8	32.6	27.2	23.3	
	5.0	M	0.76	228	182	152	130	114	91.2	76.0	57.0	50.7	45.6	36.5	30.4	26.1	
	6.0	M	0.83	249	199	166	142	125	99.6	83.0	62.3	55.3	49.8	39.8	33.2	28.5	
AIXR11002 (50)	1.0	XC	0.46	138	110	92.0	78.9	69.0	55.2	46.0	34.5	30.7	27.6	22.1	18.4	15.8	
	2.0	VC	0.65	195	156	130	111	97.5	78.0	65.0	48.8	43.3	39.0	31.2	26.0	22.3	
	3.0	C	0.79	237	190	158	135	119	94.8	79.0	59.3	52.7	47.4	37.9	31.6	27.1	
	4.0	M	0.91	273	218	182	156	137	109	91.0	68.3	60.7	54.6	43.7	36.4	31.2	
	5.0	M	1.02	306	245	204	175	153	122	102	76.5	68.0	61.2	49.0	40.8	35.0	
	6.0	M	1.12	336	269	224	192	168	134	112	84.0	74.7	67.2	53.8	44.8	38.4	
AIXR110025 (50)	1.0	XC	0.57	171	137	114	97.7	85.5	68.4	57.0	42.8	38.0	34.2	27.4	22.8	19.5	
	2.0	VC	0.81	243	194	162	139	122	97.2	81.0	60.8	54.0	48.6	38.9	32.4	27.8	
	3.0	VC	0.99	297	238	198	170	149	119	99.0	74.3	66.0	59.4	47.5	39.6	33.9	
	4.0	C	1.14	342	274	228	195	171	137	114	85.5	76.0	68.4	54.7	45.6	39.1	
	5.0	C	1.28	384	307	256	219	192	154	128	96.0	85.3	76.8	61.4	51.2	43.9	
	6.0	M	1.40	420	336	280	240	210	168	140	105	93.3	84.0	67.2	56.0	48.0	
AIXR11003 (50)	1.0	XC	0.68	204	163	136	117	102	81.6	68.0	51.0	45.3	40.8	32.6	27.2	23.3	
	2.0	VC	0.96	288	230	192	165	144	115	96.0	72.0	64.0	57.6	46.1	38.4	32.9	
	3.0	VC	1.18	354	283	236	202	177	142	118	88.5	78.7	70.8	56.6	47.2	40.5	
	4.0	C	1.36	408	326	272	233	204	163	136	102	90.7	81.6	65.3	54.4	46.6	
	5.0	C	1.52	456	365	304	261	228	182	152	114	101	91.2	73.0	60.8	52.1	
	6.0	M	1.67	501	401	334	286	251	200	167	125	111	100	80.2	66.8	57.3	
AIXR11004 (50)	1.0	UC	0.91	273	218	182	156	137	109	91.0	68.3	60.7	54.6	43.7	36.4	31.2	
	2.0	XC	1.29	387	310	258	221	194	155	129	96.8	86.0	77.4	61.9	51.6	44.2	
	3.0	VC	1.58	474	379	316	271	237	190	158	119	105	94.8	75.8	63.2	54.2	
	4.0	VC	1.82	546	437	364	312	273	218	182	137	121	109	87.4	72.8	62.4	
	5.0	C	2.04	612	490	408	350	306	245	204	153	136	122	97.9	81.6	69.9	
	6.0	C	2.23	669	535	446	382	335	268	223	167	149	134	107	89.2	76.5	
AIXR11005 (50)	1.0	UC	1.14	342	274	228	195	171	137	114	85.5	76.0	68.4	54.7	45.6	39.1	
	2.0	XC	1.61	483	386	322	276	242	193	161	121	107	96.6	77.3	64.4	55.2	
	3.0	VC	1.97	591	473	394	338	296	236	197	148	131	118	94.6	78.8	67.5	
	4.0	VC	2.27	681	545	454	389	341	272	227	170	151	136	109	90.8	77.8	
	5.0	C	2.54	762	610	508	435	381	305	254	191	169	152	122	102	87.1	
	6.0	C	2.79	837	670	558	478	419	335	279	209	186	167	134	112	95.7	
AIXR11006 (50)	1.0	UC	1.37	411	329	274	235	206	164	137	103	91.3	82.2	65.8	54.8	47.0	
	2.0	XC	1.94	582	466	388	333	291	233	194	146	129	116	93.1	77.6	66.5	
	3.0	VC	2.37	711	569	474	406	356	284	237	178	158	142	114	94.8	81.3	
	4.0	VC	2.74	822	658	548	470	411	329	274	206	183	164	132	110	93.9	
	5.0	C	3.06	918	734	612	525	459	367	306	230	204	184	147	122	105	
	6.0	C	3.35	1005	804	670	574	503	402	335	251	223	201	161	134	115	
AIXR11008 (50)	1.0	UC	1.82	546	437	364	312	273	218	182	137	121	109	87.4	72.8	62.4	
	2.0	XC	2.58	774	619	516	442	387	310	258	194	172	155	124	103	88.5	
	3.0	VC	3.16	948	758	632	542	474	379	316	237	211	190	152	126	108	
	4.0	VC	3.65	1095	876	730	626	548	438	365	274	243	219	175	146	125	
	5.0	VC	4.08	1224	979	816	699	612	490	408	306	272	245	196	163	140	
	6.0	C	4.47	1341	1073	894	766	671	536	447	335	298	268	215	179	153	
AIXR11010	1.0	UC	2.28	684	547	456	391	342	274	228	171	152	137	109	91.2	78.2	
	2.0	UC	3.23	969	775	646	554	485	388	323	242	215	194	155	129	111	
	3.0	XC	3.95	1185	948	790	677	593	474	395	296	263	237	190	158	135	
	4.0	VC	4.56	1368	1094	912	782	684	547	456	342	304	274	219	182	156	
	5.0	VC	5.10	1530	1224	1020	874	765	612	510	383	340	306	245	204	175	
	6.0	VC	5.59	1677	1342	1118	958	839	671	559	419	373	335	268	224	192	

Note: Always double check your application rates. Tabulations are based on spraying water at 21°C.

 EXTREMELY FINE	 VERY FINE	 FINE	 MEDIUM	 COARSE	 VERY COARSE	 EXTREMELY COARSE	 ULTRA COARSE	Droplet Size Categories may vary with nozzle capacity, spray angle and spray pressure
--	---	--	--	--	--	--	--	---

