

TTI TWINJET®

AIR INDUCTION DOBBELTE FLADSPREDEDYSER

TTI60 dobbelt fladsprededyse med Air Induction giver særdeles grove og ultra grove dråber der sørger for fremragende afdriftskontrol sammen med den forbedrede dækning fra dobbelt dysen. Designet af den alt-i-én støbte dyseholder og dyse giver mulighed for en hurtig og nem montering og har, modsat andre dobbelt dyser, en meget kompakt størrelse. TTI60 er fremragende til systemisk applikation af herbicider efter fremspiring.

BESKRIVELSE:

- TTI60 frembringer to 110° bredvinklede flade stråler for ensartet dækning af breddsæede afgrøder
- 60° vinkel mellem sprøjtemønstrene for og bag, til øget nedtrængning og bladdækning
- Alt-i-én støbt dyseholder og dyse med Quick TeeJet® Cap design for nem håndtering og hurtig montering
- Giver i kraft af venturiluftindsugning ekstremt store luftfyldte dråber
- Giver fremragende afdriftskontrol og frembringer minimale drivbare dråber - mindre end 1.5%*
- Støbt i acetal med fortræffelig kemikalie- og slidbestandighed
- Aftagelig indsats muliggør demontering og rengøring.
- Anbefalet arbejdsstryk: 1.5-7 bar (20-100 PSI)

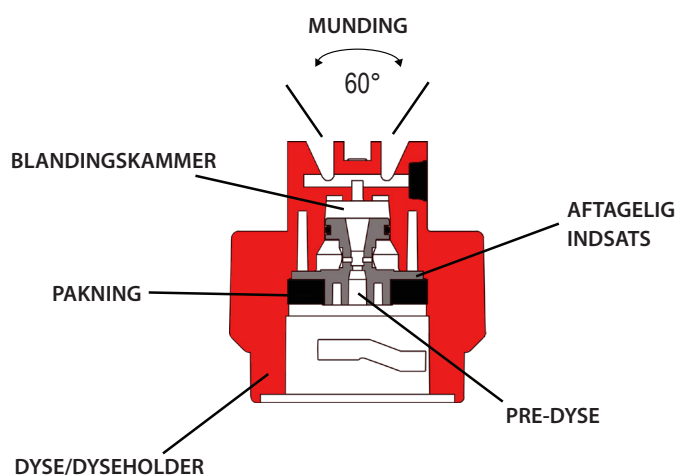

TTI60 TVÆRSNIT

TTI60 SPRØJTEDYSE



DRÅBESTØRRELSE OG DÆKNING

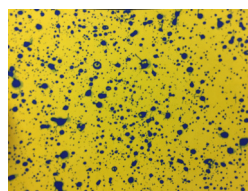

TURBO TEEJET® (TT)
(Medium)



TTI TWINJET® (TTI60)
(Særdeles grove)

GUIDE TIL DYSEVALG

KONTAKTMIDDEL	SYSTEMISK MIDDEL	AFDRIFTS KONTROL
-	FORTRÆFFELIG	FORTRÆFFELIG







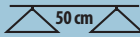

* Ved en 04 dyse der sprøjter vand ved 2.8 bar (40PSI). Drivbare dråber er defineret som dråber med mindre end 150 microner.

TTITWINJET® DOBBELT FLADSPREDEDYSE

UDBRINGINGS INFORMATION

TTI60-11002VP (50)	bar	DRÅBESTØRRELSE	KAPACITET pr. DYSE i l/MIN	l/ha 												
				4 km/t	5 km/t	6 km/t	7 km/t	8 km/t	10 km/t	12 km/t	16 km/t	18 km/t	20 km/t	25 km/t	30 km/t	35 km/t
TTI60-11002VP (50)	1.5	UC	0.56	168	134	112	96.0	84.0	67.2	56.0	42.0	37.3	33.6	26.9	22.4	19.2
	2.0	UC	0.65	195	156	130	111	97.5	78.0	65.0	48.8	43.3	39.0	31.2	26.0	22.3
	3.0	XC	0.79	237	190	158	135	119	94.8	79.0	59.3	52.7	47.4	37.9	31.6	27.1
	4.0	VC	0.91	273	218	182	156	137	109	91.0	68.3	60.7	54.6	43.7	36.4	31.2
	5.0	VC	1.02	306	245	204	175	153	122	102	76.5	68.0	61.2	49.0	40.8	35.0
	6.0	VC	1.12	336	269	224	192	168	134	112	84.0	74.7	67.2	53.8	44.8	38.4
	7.0	C	1.21	363	290	242	207	182	145	121	90.8	80.7	72.6	58.1	48.4	41.5
TTI60-110025VP (50)	1.5	UC	0.70	210	168	140	120	105	84.0	70.0	52.5	46.7	42.0	33.6	28.0	24.0
	2.0	UC	0.81	243	194	162	139	122	97.2	81.0	60.8	54.0	48.6	38.9	32.4	27.8
	3.0	XC	0.99	297	238	198	170	149	119	99.0	74.3	66.0	59.4	47.5	39.6	33.9
	4.0	VC	1.14	342	274	228	195	171	137	114	85.5	76.0	68.4	54.7	45.6	39.1
	5.0	VC	1.28	384	307	256	219	192	154	128	96.0	85.3	76.8	61.4	51.2	43.9
	6.0	VC	1.40	420	336	280	240	210	168	140	105	93.3	84.0	67.2	56.0	48.0
	7.0	C	1.51	453	362	302	259	227	181	151	113	101	90.6	72.5	60.4	51.8
TTI60-11003VP (50)	1.5	UC	0.83	249	199	166	142	125	99.6	83.0	62.3	55.3	49.8	39.8	33.2	28.5
	2.0	UC	0.96	288	230	192	165	144	115	96.0	72.0	64.0	57.6	46.1	38.4	32.9
	3.0	UC	1.18	354	283	236	202	177	142	118	88.5	78.7	70.8	56.6	47.2	40.5
	4.0	XC	1.36	408	326	272	233	204	163	136	102	90.7	81.6	65.3	54.4	46.6
	5.0	XC	1.52	456	365	304	261	228	182	152	114	101	91.2	73.0	60.8	52.1
	6.0	VC	1.67	501	401	334	286	251	200	167	125	111	100	80.2	66.8	57.3
	7.0	VC	1.80	540	432	360	309	270	216	180	135	120	108	86.4	72.0	61.7
TTI60-11004VP (50)	1.5	UC	1.12	336	269	224	192	168	134	112	84.0	74.7	67.2	53.8	44.8	38.4
	2.0	UC	1.29	387	310	258	221	194	155	129	96.8	86.0	77.4	61.9	51.6	44.2
	3.0	UC	1.58	474	379	316	271	237	190	158	119	105	94.8	75.8	63.2	54.2
	4.0	XC	1.82	546	437	364	312	273	218	182	137	121	109	87.4	72.8	62.4
	5.0	XC	2.04	612	490	408	350	306	245	204	153	136	122	97.9	81.6	69.9
	6.0	VC	2.23	669	535	446	382	335	268	223	167	149	134	107	89.2	76.5
	7.0	VC	2.41	723	578	482	413	362	289	241	181	161	145	116	96.4	82.6
TTI60-11005VP (50)	1.5	UC	1.39	417	334	278	238	209	167	139	104	92.7	83.4	66.7	55.6	47.7
	2.0	UC	1.61	483	386	322	276	242	193	161	121	107	96.6	77.3	64.4	55.2
	3.0	UC	1.97	591	473	394	338	296	236	197	148	131	118	94.6	78.8	67.5
	4.0	XC	2.27	681	545	454	389	341	272	227	170	151	136	109	90.8	77.8
	5.0	XC	2.54	762	610	508	435	381	305	254	191	169	152	122	102	87.1
	6.0	VC	2.79	837	670	558	478	419	335	279	209	186	167	134	112	95.7
	7.0	VC	3.01	903	722	602	516	452	361	301	226	201	181	144	120	103
TTI60-11006VP (50)	1.5	UC	1.68	504	403	336	288	252	202	168	126	112	101	80.6	67.2	57.6
	2.0	UC	1.94	582	466	388	333	291	233	194	146	129	116	93.1	77.6	66.5
	3.0	UC	2.37	711	569	474	406	356	284	237	178	158	142	114	94.8	81.3
	4.0	XC	2.74	822	658	548	470	411	329	274	206	183	164	132	110	93.9
	5.0	XC	3.06	918	734	612	525	459	367	306	230	204	184	147	122	105
	6.0	XC	3.35	1005	804	670	574	503	402	335	251	223	201	161	134	115
	7.0	VC	3.62	1086	869	724	621	543	434	362	272	241	217	174	145	124
TTI60-11008VP (50)	1.5	UC	2.23	669	535	446	382	335	268	223	167	149	134	107	89.2	76.5
	2.0	UC	2.58	774	619	516	442	387	310	258	194	172	155	124	103	88.5
	3.0	UC	3.16	948	758	632	542	474	379	316	237	211	190	152	126	108
	4.0	UC	3.65	1095	876	730	626	548	438	365	274	243	219	175	146	125
	5.0	UC	4.08	1224	979	816	699	612	490	408	306	272	245	196	163	140
	6.0	XC	4.47	1341	1073	894	766	671	536	447	335	298	268	215	179	153
	7.0	XC	4.83	1449	1159	966	828	725	580	483	362	322	290	232	193	166

BEMÆRK: Kontrollér altid din udbringningsmængde. Opstillingen er baseret på vand ved 21°C.

 SÆRDELES FIN	 MEGET FIN	 FIN	 MEDIUM	 GROVE	 MEGET GROVE	 SÆRDELES GROVE	 ULTRA GROVE	Dråbestørrelseskategorier kan variere ved kapacitet af dysen, sprøjtevinklen og sprøjtetrykket
--	---	---	--	---	---	--	---	--

VED BESTILLING

Eksempel:

VARENUMMER	BESKRIVELSE
TTI60-11002VP	Polymer med VisiFlo® farvekodning

OPTIMAL SPRØJTEHØJDE

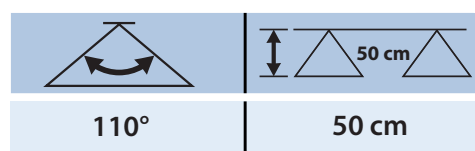

TeeJet
TECHNOLOGIES