

MATRIX[®] 430

USER MANUAL

98-05332 R4











TeeJet[®]
TECHNOLOGIES





A Subsidiary of  Spraying Systems Co.[®]

QUICK START GUIDE

SETUP THE CONSOLE

1. On guidance screen, press NAVIGATION AND GUIDANCE OPTIONS tab  to display options.
2. Press HOME button .
3. Press CONSOLE button . Adjust settings as needed.
 - ▶ LCD Brightness 
 - ▶ Colour Scheme 
 - ▶ Units 
 - ▶ GNSS Demo Mode 
 - ▶ Screenshot 
 - ▶ Time Zone 

















CONFIGURE THE MACHINE

4. From the Home screen , press CONFIGURATION button .
5. Select and configure a Machine profile .
 - ▶ Select Machine Profile Number **A** – use to select 1 of 5 machine profiles. The profile that is “active” is displayed/active on the operation screen.
 - ▶ Set Number of Implement Sections **B** – used to select the number of implement sections. Range is 1 to 7 sections.
 - ▶ Set Section Widths **C** – used to enter the width of each section. Each section can be a different width.
 - ▶ Set Lateral Implement Offset Distance **D** – used to define the lateral distance from the centre line of the machine to the centre of the implement.
 - Positive value will move the implement to the right of centre while facing in the machine’s forward direction.
 - Negative value will move the implement to the left of centre while facing in the machine’s forward direction.
 - ▶ Set In-Line Implement Offset Distance **E** – used to define the in-line distance from the GNSS antenna (the zero point) to the implement.
 - Positive value will move the implement behind the GNSS antenna.
 - Negative value will move the implement in front of the GNSS antenna.
6. Select Lighbar Spacing  – used to set the distance away from the guideline or vehicle each guidance screen lightbar box represents.
7. Set GNSS configuration . GPS uncorrected signals from the GPS system are always available and cannot be disabled.
 - ▶ Set SBAS Usage **F** – used to select if any satellite-based differential correction system (SBAS) will be used.
 - ▶ Select Minimum Position Quality Requirement **G** – used to select between using ClearPath® or SBAS.
 - ▶ Select Additional Constellations **H** – used to Indicated when the GLONASS or QZSS uncorrected signals are available.





NOTE: When using the Matrix 430 in Europe, always include GLONASS. Use SBAS (EGNOS) where applicable.



SETUP GUIDANCE

- From the Home screen , press GUIDANCE button .
- Establish desired Selectable Guidance Bar Information.
 - Speed 
 - Total Applied Area 
 - Application Time 
 - Swath Number 
- On vehicle view guidance screen, from the NAVIGATION AND GUIDANCE OPTIONS tab , select Guidance mode 
 - Straight AB guidance 
 - Last pass guidance 
 - No guidance 
 - Curved AB guidance 
 - Circle pivot guidance 
 - NextRow guidance 
- On vehicle view guidance screen, from the NAVIGATION AND GUIDANCE OPTIONS tab , create boundary 
 - Create AB guideline 

GUIDANCE SCREEN OPTIONS

- ▶ Application Mapping – press VEHICLE icon  in the centre of the guidance screen to turn on or off application mapping.
- ▶ Return to Point  – set a return point to provide guidance back to the established point.
- ▶ A+ Nudge Feature  – allows the current guideline to be shifted to the vehicle's current location.
- ▶ Transport Mode  – recommended for use when traveling between fields as this will improve accuracy in guidance functions.

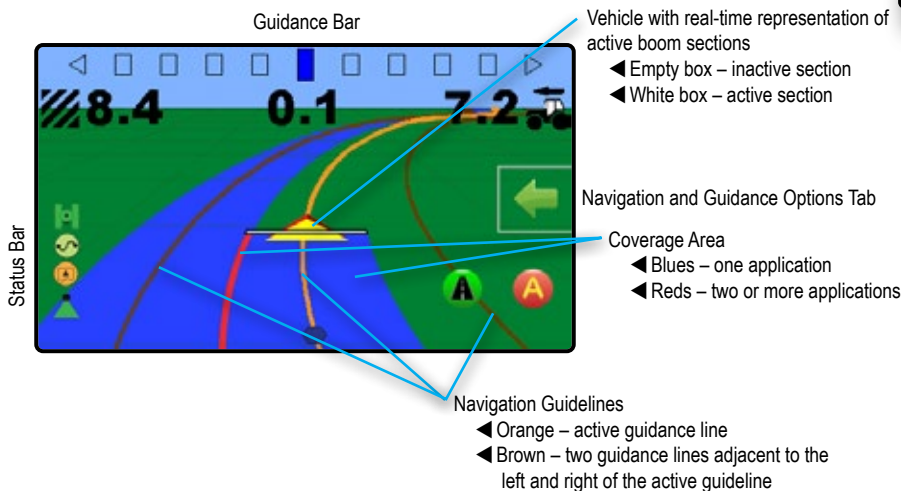
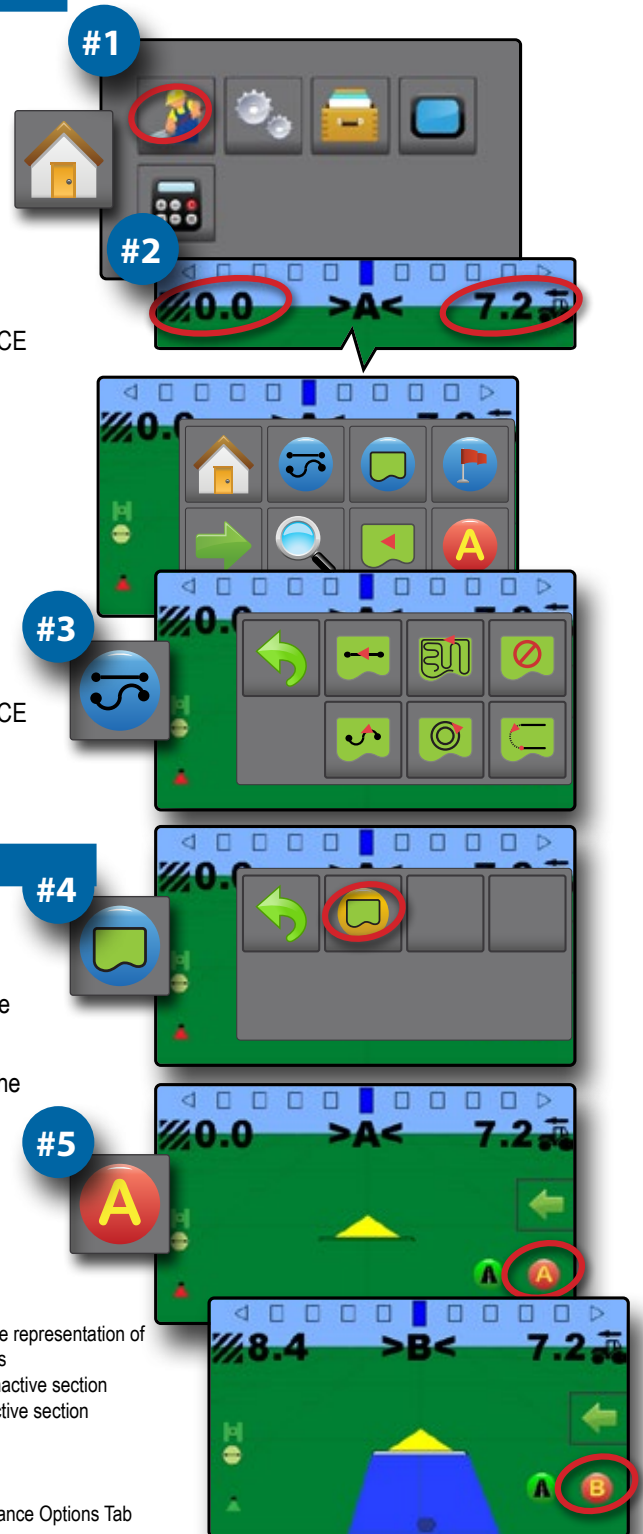

Table of contents

INTRODUCTION	QUICK START GUIDE	2
	SETUP THE CONSOLE	2
	CONFIGURE THE MACHINE	2
GUIDANCE	SETUP GUIDANCE	3
	GUIDANCE SCREEN OPTIONS	3
	IMPORTANT SAFETY INFORMATION	VI
	GENERAL WARNINGS AND PRECAUTIONS	VI
CONFIGURATION	CHAPTER 1 – INTRODUCTION	1
	SYSTEM COMPONENTS	1
	Matrix 430 Console	1
	System Components	1
	Recommended Antenna Installation	1
	POWER	2
JOB DATA	BASIC SCREEN USE	2
	Home Screen	2
	Keyboard Entry Screens	3
	Options Menus	3
CONSOLE	ICON REFERENCE	3
	OVERHEAT WARNING	4
	CHAPTER 2 – GUIDANCE	5
	GUIDANCE SCREEN OPTIONS AND INFORMATION	5
	Guidance Views	5
	Vehicle View Navigation	5
	Field View Navigation	6
	Guidance Bar	6
	Status Bar	7
	Transport Mode	8
	Guidelines	8
	Marking A and B Points	8
	A+ Nudge Feature	9
	NextRow	9
	NAVIGATION AND GUIDANCE OPTIONS TAB	10
	Guidance Modes	11
	Application Boundary	12
	Creating a Boundary	12
	Delete the Boundary	13
	Return to Point	13
	Marking a Return Point	13
	Guidance to a Return Point	14
	Delete the Return Point	14

Zoom In/Out.....	14
Pan	15
APPLICATION MAPPING & APPLIED ALERT	16
Mapping with Console Only	16
Mapping with Work On/Off Switch	16
Applied Alert.....	16

CHAPTER 3 – CONFIGURATION 17

Machine Configuration.....	17
Lightbar Spacing.....	18
GNSS Receiver Configuration.....	18
Not Acceptable GNSS Notification.....	19

CHAPTER 4 – JOB DATA 20

Job Data Overview	20
Delete Job Data	20
Reports	21
Memory Notifications	21

CHAPTER 5 – CONSOLE 22

Copyrights

© 2023 TeeJet Technologies. All rights reserved. No part of this document or the computer programmes described in it may be reproduced, copied, photocopied, translated, or reduced in any form or by any means, electronic or machine readable, recording or otherwise, without prior written consent from TeeJet Technologies.

Trademarks

Unless otherwise noted, all other brand or product names are trademarks or registered trademarks of their respective companies or organisations.

Limitation of Liability

TEEJET TECHNOLOGIES PROVIDES THIS MATERIAL “AS IS” WITHOUT WARRANTY OF ANY KIND, EITHER EXPRESSED OR IMPLIED. NO COPYRIGHT LIABILITY OR PATENT IS ASSUMED. IN NO EVENT SHALL TEEJET TECHNOLOGIES BE LIABLE FOR ANY LOSS OF BUSINESS, LOSS OF PROFIT, LOSS OF USE OR DATA, INTERRUPTION OF BUSINESS, OR FOR INDIRECT, SPECIAL, INCIDENTAL, OR CONSEQUENTIAL DAMAGES OF ANY KIND, EVEN IF TEEJET TECHNOLOGIES HAS BEEN ADVISED OF SUCH DAMAGES ARISING FROM TEEJET TECHNOLOGIES SOFTWARE.

IMPORTANT SAFETY INFORMATION

All safety related and operating instructions should be read before the system is operated. Safe operation of machinery is the operators responsibility. Safety procedures must be posted close to the equipment and clearly visible to and legible by the operator. Safety procedures should meet all company and local regulations, as well as MSDS-requirements. For assistance, contact a local dealer.

Safety Alert Symbol Definitions:



DANGER! This symbol is reserved for the most extreme situations where serious personal injury or death is imminent.



WARNING! This symbol indicates a hazardous situation that could result in serious personal injury or death.



CAUTION! This symbol indicates a hazardous situation that could result in minor or moderate personal injury.



NOTE: This symbol addresses practices in which the operator should be aware.

GENERAL WARNINGS AND PRECAUTIONS



DANGER!

- Read and follow instructions. If instructions are unclear after reading the manual, please contact a local dealer.
- Keep children away from equipment.
- Do not operate machinery under the influence of alcohol or any illegal substance.
- Some systems include a fan heater. Never cover the heater otherwise there will be a serious danger of fire!



WARNING! ELECTRICAL / SHOCK HAZARDS

- Before working on any particular component, make sure that all power supplies have been switched off and cannot be accidentally switched on.
- Disconnect power leads before using an arc welder on equipment or anything connected to the equipment.
- Systems including frequency drives have a risk of electric shock due to residual voltage. It is not permissible to open the equipment neither to disconnect the system or any quick connection until 5 minutes after the power has been removed.
- Only operate the system from the power source indicated in the manual. If you are not sure of the power source, consult qualified service personnel.
- Do not use a high pressure cleaner to clean electrical components. This could damage electrical components and subject the operator to risk of electrical shock.
- The electrical supply to the equipment must be properly routed and connected to the equipment. All connections must meet the specified requirements.



WARNING! PRESSURISED HYDRAULIC SYSTEMS

- Always wear personal protective equipment (PPE) when performing work on hydraulic systems.
- Adhere to the machine manufacture's approved maintenance instructions when working on the hydraulic system.
- Always turn equipment off when working on the hydraulic system. Take appropriate precautions when opening systems that have been previously pressurised.
- Be aware that hydraulic oil may be extremely hot and under high pressure.



WARNING! CHEMICAL HANDLING

- Always wear PPE when handling any chemical substance.
- Always follow safety labels and instructions provided by the chemical manufacturer or supplier.
- The operator should have full information on the nature and the quantity of the material to be distributed.
- **ADHERE TO FEDERAL, STATE AND LOCAL REGULATIONS REGARDING THE HANDLING, USE OR DISPOSAL OF AGRICULTURAL CHEMICALS.**



WARNING! PRESSURISED SPRAY SYSTEM

- It is important to recognise proper safety precautions when using a pressurised spray system. Fluids under pressure can penetrate skin and cause serious personal injury.
- The system pressure should never exceed the lowest rated component. Always know your system and all component capabilities, maximum pressures and flow rates.
- Filters can only be opened when the manual valves in front of and behind the filter are in closed position. If any appliance has to be taken out of the piping, manual valves in front of and behind this appliance have to be in closed position. If they are reinstalled, make sure that this happens correctly, that this apparatus is well aligned, and that all connections are tight.
- The plumbing supply to the equipment should meet all company and local regulations and must be properly routed and connected to the equipment. All connections must meet the specified requirements.
- It is advised to drain and purge the liquid train when the equipment shall not be used for a longer period of time.



WARNING! AUTO STEERING SAFETY

- To prevent serious personal injury or death from being run over by the vehicle or automated motion of the steering system, never leave the vehicles operator seat with the system engaged.
- To prevent serious personal injury or death from being run over by the vehicle or automated motion of the steering system, verify the area around the vehicle is clear of people or obstacles before startup, calibration, tuning or engaging the system.
- Make sure equipment is tightly secured to the proper components.
- Never drive on public roads with system engaged.



CAUTION! EQUIPMENT SAFETY, MAINTENANCE, AND SERVICE

- The equipment should be operated only by properly trained, qualified personnel. They must have proven their skills in the operation of the equipment.
- Before using the equipment, the operator has to check if the equipment is in good condition and can be used safely. If not, the equipment cannot be used.
- All necessary PPE must be readily available to the operator at all times.
- Routinely check the system and components for wear and damage. Replace or repair when necessary.
- Only qualified authorised experts are allowed to repair or maintain the installation. The maintenance and operating instructions shall be rigidly observed and followed.
- A complete manual for the equipment must be available to the operator or maintenance technician at all times.



CAUTION! HARNESS CABLE AND HOSE SAFETY

- Routinely check all harness cables and hoses for damage or wear. Replace or repair when necessary.
- Do not route harness cables and hoses with sharp bends.
- Do not strap harness cables and hoses to lines with high vibration or spikes in pressure.
- Do not strap harness cables and hoses to lines transporting hot fluids.
- Protect harness cables and hoses from sharp objects, equipment debris, and material buildup.
- Allow sufficient length for harness cables and hoses to have free movement on sections that move during operation, and be sure that harness cables or hoses do not hang below the equipment.
- Allow sufficient clearance for harness cables and hoses from implement and machine operational zones.
- When cleaning equipment, protect harness cables from high pressure wash.



NOTE: TOUCH SCREEN CARE

- Keep sharp objects away from the touch screen device. Touching the screen with a sharp object could result in damage to the display.
- Do not use harsh chemicals to clean the console/display. The correct way to clean a console/display is to use a soft damp cloth or anti-static wipe, similar to cleaning a monitor on a computer.



NOTE: RECOMMENDED REPLACEMENT PARTS

- The system has been designed with components that work together to provide the best system performance. When the system requires replacement parts, only TeeJet recommended components should be used to maintain proper system operation and safety.



END USER LICENSE AGREEMENT

- ALWAYS READ AND FOLLOW THE CHEMICAL LABEL'S DIRECTIONS. Droplet size classification is in accordance with ISO 25358 at the date of publication. Classifications are subject to change. The chemical being sprayed, tank mixes, temperature, humidity, wind speed, vehicle speed, etc. can influence the actual drop size.

CHAPTER 1 – INTRODUCTION

SYSTEM COMPONENTS

Matrix 430 Console

The console is designed to provide years of service under typical agricultural operating conditions. A tight fitting enclosure, combined with rubber covers for all connectors means that typical dusty environments will not cause operational problems. While occasional splashing of water will not damage the unit, the console is not designed for direct exposure to rain. Take care not to operate the console in wet conditions.

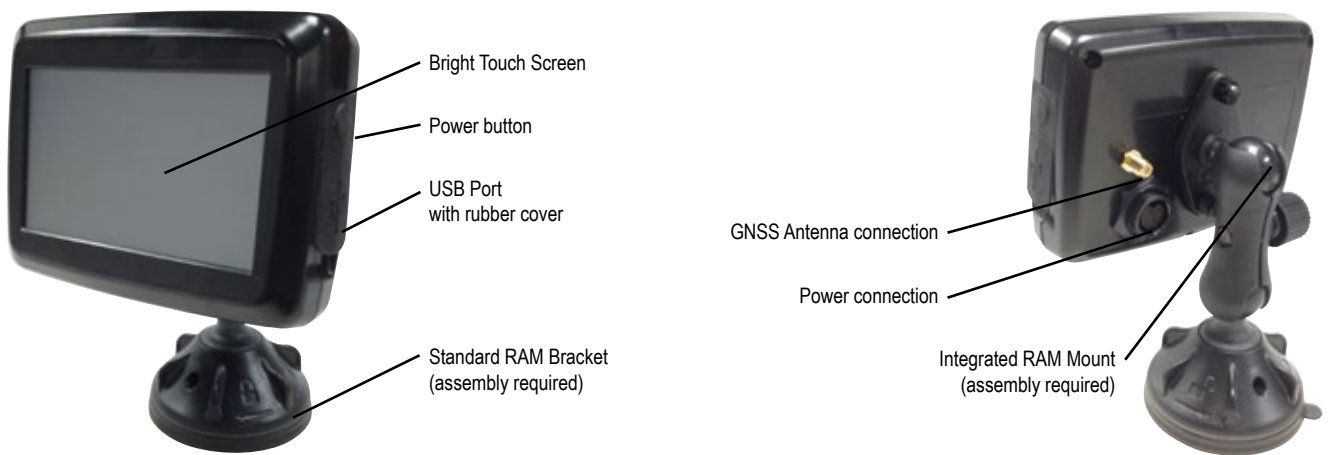

System Components

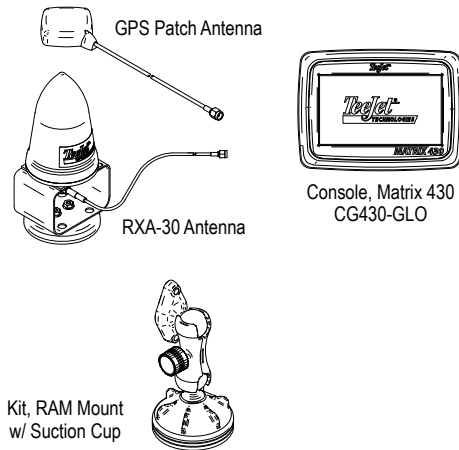

Power Cables

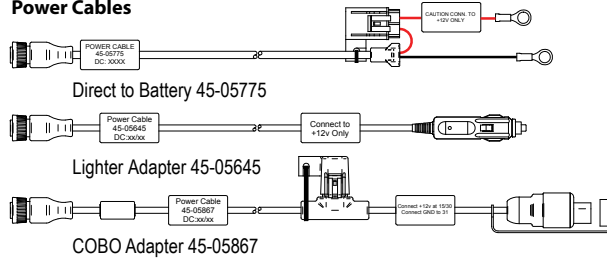

Power/Sense/Speed Cables

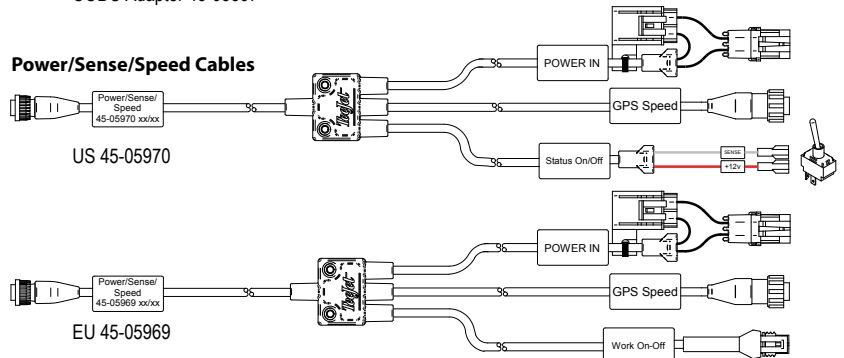

The console needs to be cycled off and back on when changing or attaching equipment to the Matrix 430 system.

Recommended Antenna Installation



The GNSS antenna should be mounted as far forward as possible on top of the cab on a metal surface of at least 4"/10 cm square.

POWER

Power On

1. Press POWER button .

Power Off

1. Press POWER button .
2. Select from:
 - ▶ Accept  – to continue shut down
 - ▶ Cancel  – to keep the console on.

WARNING! Wait 30 seconds before restarting the console after powering off.

Home Screen



The Home screen gives access to guidance, configuration, job data and a calculator.

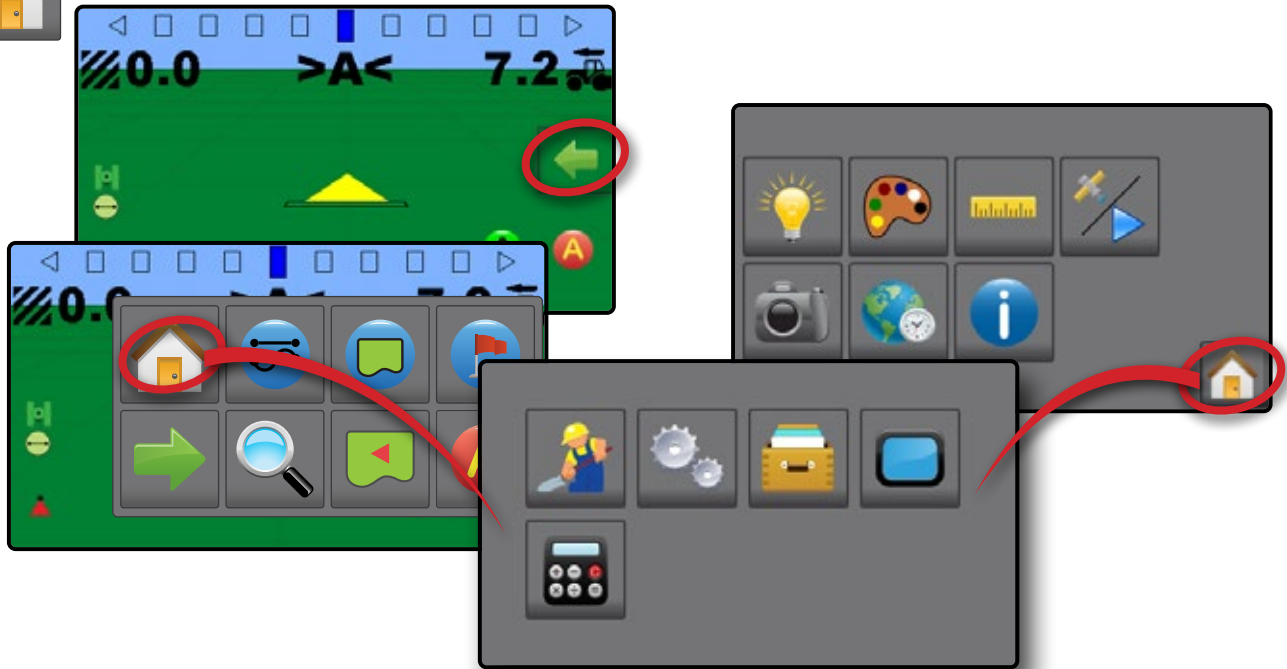

BASIC SCREEN USE

The basic screen functions are:

- Home button accesses the Home screen with setup buttons for Guidance, Configuration, Job Data, Console settings and a calculator
- Options tab on the Guidance screen accesses the Home button and navigation options
- Warnings and information pop-ups inform of console activities and details on configuration or application functions
- Configuration options can be applied using option menus or keyboard entry screens

NOTE: When application is active, some configuration options are unavailable.

Guidance

Used to view a computer-generated image of the vehicle position displayed in the application area. From this screen all setup and navigation options can be accessed via the tab on the right side of the screen.

Configuration

Used to select and setup the machine configurations, lightbar configurations and GNSS receiver.

Job Data

Used to select current job, view or delete job data and export reports.



Console

Used to setup LCD brightness, colour scheme, units, screenshot and time zone; start demonstration GNSS; and view console information.





Calculator

Keyboard Entry Screens

Some screens offer keyboard entry. Press the current selection to access the keyboard. Use the numeric keypad to enter a value.

To change a value:

3. Press CURRENT VALUE.
3. Use the numeric keypad to enter a new value.
4. Select from:
 - ▶ Accept  – to save the settings
 - ▶ Cancel  – to leave the keypad without saving

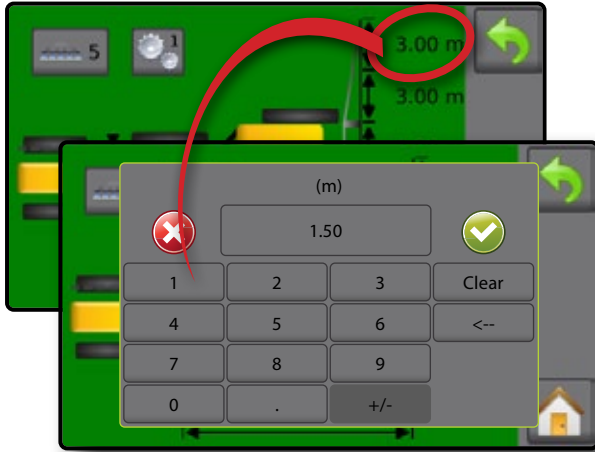

Options Menus

Press the current selection to access options. Select an appropriate option, or use a next page arrow to access additional options. To close the list without changing the current option, select the current option.

To change a value:

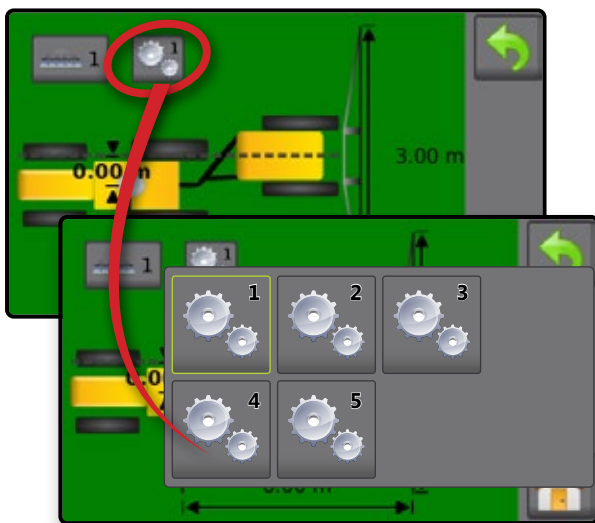

1. Press CURRENT VALUE.
2. Select an appropriate option.



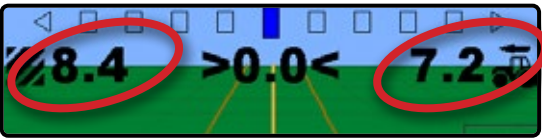

ICON REFERENCE







 **Guidance**















<p>Selectable Information</p> <ul style="list-style-type: none">  Speed  Total Applied Area 	<p> Application Time</p> <ul style="list-style-type: none">  Swath Number <input type="checkbox"/> Show nothing
---	---

- A B Mark A, Mark B
- A+ A+ Nudge Feature
-   Transport Mode / Work Mode

 Navigation and Guidance Options tab



-  Home
- Guidance Modes
 -  Straight AB guidance
 -  Last pass guidance
 -  No guidance
 -  Curved AB guidance
 -  Circle pivot guidance
 -  NextRow guidance
- Application Boundary

 Start	 Cancel
 Finish	 Delete
- Return to Point



 Mark	 Cancel
 Go to point	 Delete
-  Close Options
-  Field View
-  Vehicle View
-  Pan
-  Zoom In/Out

Configuration



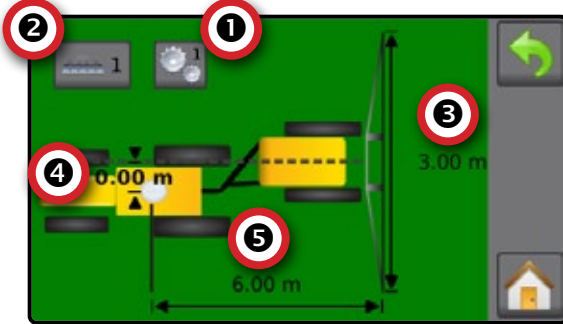

 Machine Configuration

-  **1** Machine Profile Number
-  **2** Number of Implement Sections
- 3** Section Widths
- 4** Lateral Implement Offset Distance
- 5** In-Line Implement Offset Distance











-  Lightbar spacing
-  GNSS Receiver Configuration

Job Data

-  Total Applied Area
-  Bounded Area
-  Application Time
-  Delete
-  Reports

Console

-  LCD Brightness
-  User Interface Colour Scheme
-  Units
-  Demonstration GNSS:  GNSS or  Demo
-  Screenshot
-  Time Zone
-  About

OVERHEAT WARNING

If the console exceeds its critical temperature (gets too warm), an overheat warning will be displayed, data will be saved, and will automatically power off.

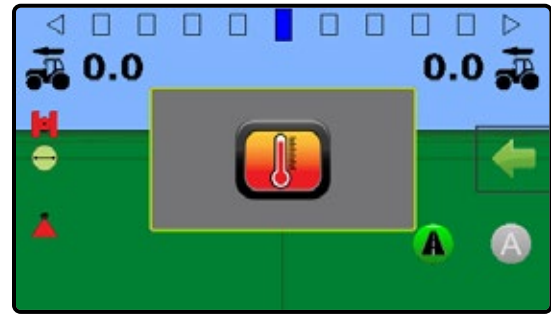

CHAPTER 2 – GUIDANCE



Two guidance screens, vehicle view and field view, assist in keeping the user informed. From the vehicle view screen, guidance setup and navigation options can be accessed via the tab on the right side of the screen.

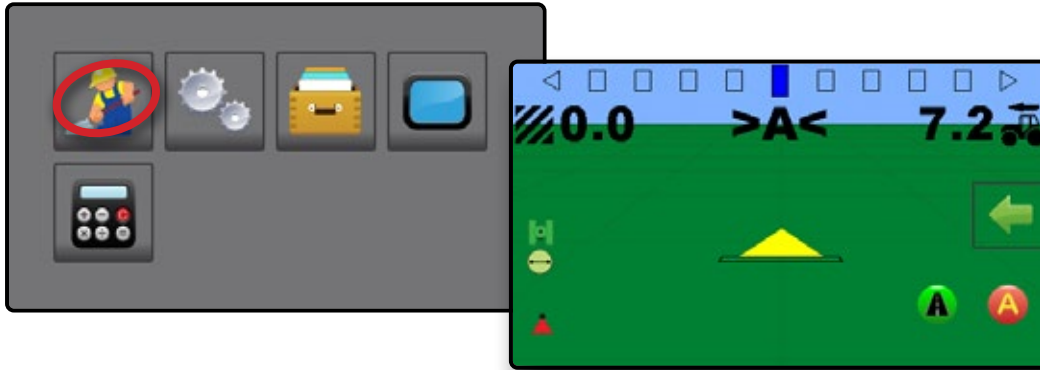

GUIDANCE SCREEN OPTIONS AND INFORMATION

Guidance Views

Vehicle View Navigation



Vehicle view guidance creates a computer-generated image of the vehicle position displayed in the application area.

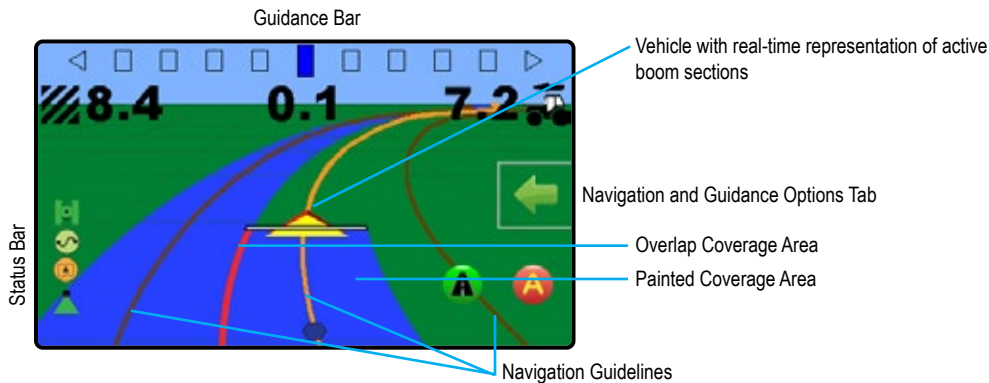

On Screen Guidance

- Guidelines:
 - ◀ Orange – active guidance line
 - ◀ Brown – two guidance lines adjacent to the left and right of the active guideline
 - ◀ Dark grey – boundary line
- Points – markers for established points:
 - ◀ Red point – Return to point
 - ◀ Blue point – Mark A
 - ◀ Green point – Mark B

- Coverage Area – illustrates applied area and overlap:
 - ◀ Blue – one application
 - ◀ Red – two or more applications

Zoom In/Out & Perspective – adjusts the vehicle's view or perspective to the horizon from vehicle view to bird's eye view.

- Boom Sections:
 - ◀ Empty box – inactive section
 - ◀ White box – active section

Field View Navigation

Field view guidance creates a computer-generated image of vehicle position and application area from an aerial perspective.

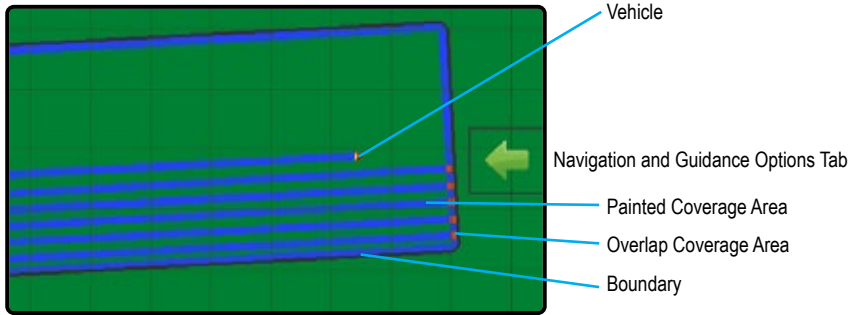

On Screen Guidance

- Guidelines:
 - Dark grey – boundary line
- Coverage Area – illustrates applied area and overlap:
 - Blue – one application
 - Red – two or more applications
- Points – markers for established points:
 - Red point – Return to point
 - Blue point – Mark A
 - Green point – Mark B

Guidance Bar

The guidance bar on the vehicle view guidance screen keeps you informed of your choice of selectable information (current speed, total applied area, application time, swath number) and navigation activity (cross track error, current activity and GNSS status).

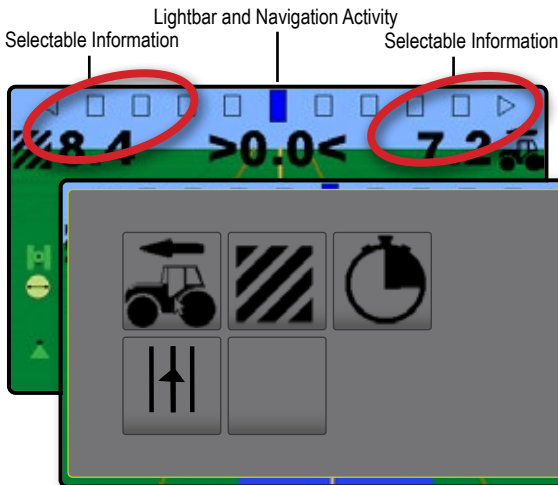

Selectable Information

- On vehicle view guidance screen, press current value and select an information button:
 - Speed – displays the current speed of travel
 - Total Applied Area – displays the total accumulated area that has had application applied including double coverage areas
 - Application Time – displays the total time application is active during the current job
 - Swath Number – displays the current swath number in reference to the initial guidance line. Number will be shown as a positive number when the vehicle is to the right of the AB baseline or a negative number when the vehicle is to the left of the AB baseline

Lightbar and Navigation Activity

- Lightbar spacing – used to represent the distance away from the guideline or vehicle.
- GNSS Status – displays flashes “GPS” when GNSS is unavailable
- Current Activity – displays activities such as mark an A or B point, distance to return to a marked point or when to turn or mark the end of a swath path
- Cross Track Error – displays the distance from your desired guideline

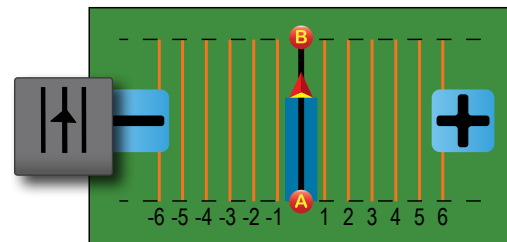

- No Information – shows no information in the display area

Status Bar

The status bar provides information on GNSS status, guidance mode, boundary area, and implement control status.

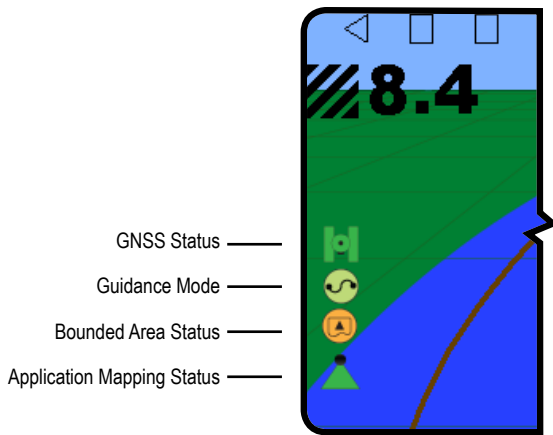



GNSS Status

Guidance Mode

Bounded Area Status

Application Mapping Status



GNSS Status

	Red = no GNSS
	GPS only
	Green = DGPS, WAAS/RTK, GLONASS



Guidance Mode

	Straight AB guidance
	Last pass guidance
No icon = no guidance	
	Curved AB guidance
	Circle pivot guidance
	NextRow guidance

Bounded Area Status

	Outside Boundary = currently traveling outside bounded area
	Inside Boundary = currently traveling inside bounded area
No icon = no boundary established	

Application Mapping Status

	Red = off
	Green = on

Status/Information Screens

To display information:

1. On vehicle view guidance screen, press status bar icon.

► GNSS Status  – displays information regarding number of satellites in view, satellite quality and receiver ID



► Bounded Area Status  – displays information regarding the area in the current boundary

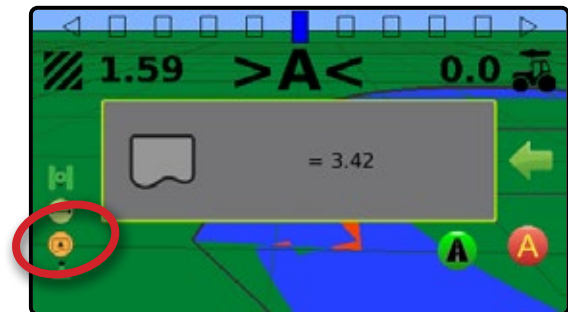

To remove the information box, tap the information box.

Transport Mode

 Transport mode is recommended for use when traveling between fields as this will improve accuracy in guidance functions.

Enable Transport Mode

To enable transport mode:

1. On vehicle view guidance screen, press the TRANSPORT MODE button .

◀ When enabled, all guidance functions are disabled.

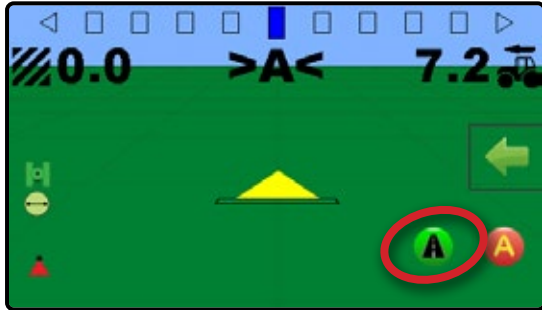

Disable Transport Mode

To disable transport mode:

1. On vehicle view guidance screen, press the GUIDANCE button .

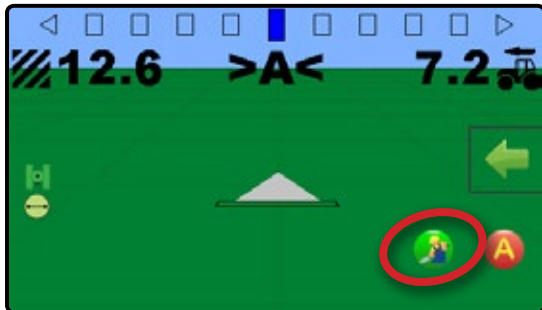

NOTE: There will be a slight delay while exiting transport mode.





Guidelines



 A guideline is established by connecting both a marked A point and a B point. This guideline can be adjusted to the vehicle's current location using the A+ nudge feature. Only one guideline per guidance mode is available per job.

Marking A and B Points

  To establish an AB guideline:

1. Drive to the desired location of Point A .
2. **While the vehicle is in motion**, on vehicle view guidance screen, press MARK A icon .



NOTE: a Mark A button  is also available on the Navigation and guidance options  menu

3. Drive to the desired location of Point B .
4. Press MARK B button  to establish the AB line.

The console will begin providing navigation information.

NOTE: The MARK B Icon  is not available for selection (greyed out) until the minimum distance is travelled (3.0 metres in Straight or Curved guidance, 50.0 metres in Circle pivot guidance).

It is not necessary to drive the entire circumference of the centre pivot in order to initiate Circle pivot guidance.

Use CANCEL MARK button  on the Navigation and guidance options  menu to cancel the Mark A command and revert to the previous guideline (when established).

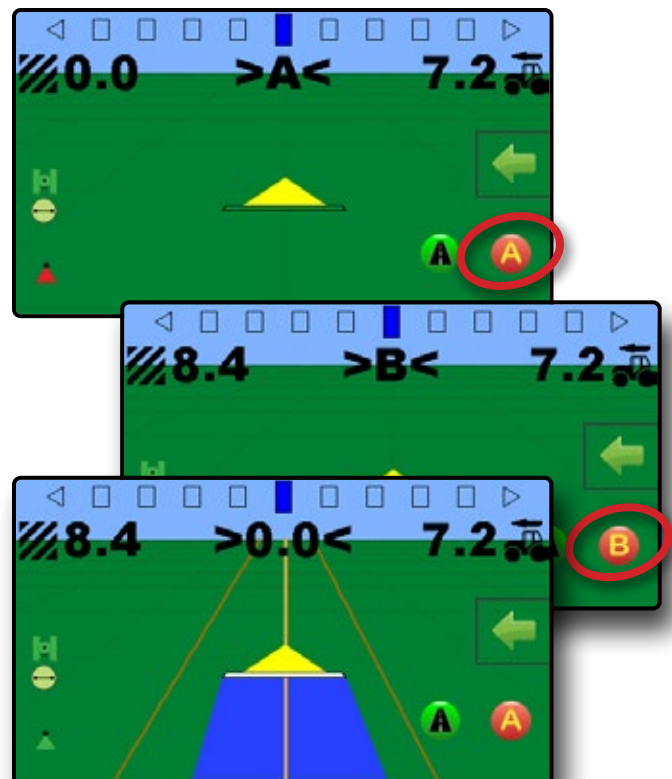

A+ Nudge Feature

A+ The A+ nudge feature allows the current guideline to be shifted to the vehicle's current location.

To adjust the guideline:

1. On vehicle view guidance screen, press A+ NUDGE button **A+**.

*NOTE: An A+ Nudge button **A+** is also available on the Navigation and guidance options  menu.*

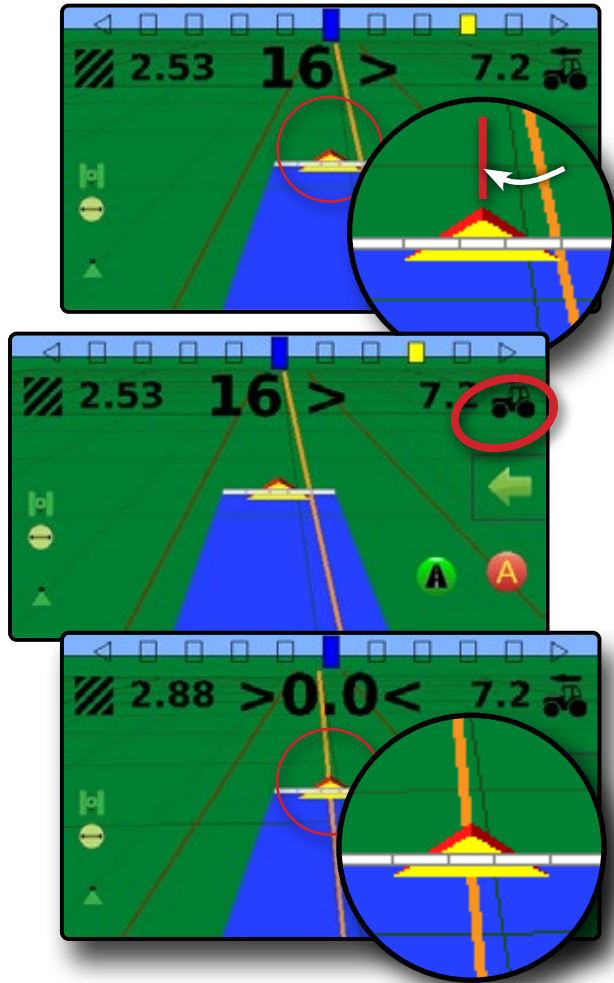

NextRow

B NextRow guidance indicates where the NextRow is located based on the working width (section width × number of sections), and provides manual guidance information at user-marked end of a row to the next adjacent row. When the operator signals the end of the row, a Straight AB line will be established in the current row and guidance will be provided to the next row. Once the vehicle has entered into the next row, no guidance or guidelines are shown.

To activate NextRow guidelines:

1. At the end of a row (while driving a straight line) on vehicle view guidance screen, press MARK B icon **B**.
 - ◀ The end of the row will be marked with a green point .
 - ◀ The navigation information will change to **<<<>>>** to indicate it is time to turn.
2. Turn toward the next row.
3. Based on that direction turned, guidance will be provided for the next adjacent row.
 - ◀ When the vehicle is in the row, the guideline is removed.
 - ◀ The navigation information will change to **>>><<<** to indicate it is time to again mark the end of the row.
4. Repeat at the end of the next row.

NOTE: The NextRow guidance feature does not support skipping rows.

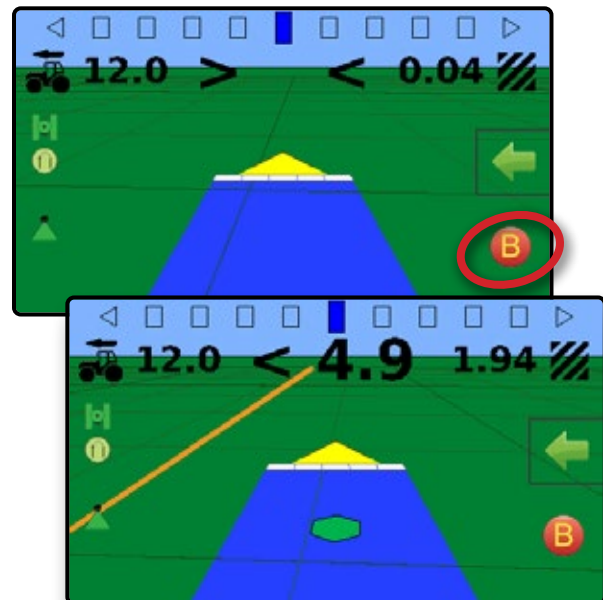























NAVIGATION AND GUIDANCE OPTIONS TAB

The Navigation and Guidance Options Tab is always available on the Guidance screen. This tab accesses the menu with the Home button, guidance modes and navigation options.





Vehicle View

Navigation and Guidance Options Tab Menu Buttons

-  Home – used to access Home screen
-  Guidance Views – used to change between Vehicle View and Field View
-  Guidance Modes – used to change guidance mode:
 -  Straight AB Guidance
 -  Curved AB Guidance
 -  Last Pass Guidance
 -  Circle Pivot Guidance
 -  No Guidance
 -  NextRow Guidance
-  Application Boundary – used to create or delete a boundary
 -  Start Creating Boundary
 -  Cancel Boundary Creation
 -  Finish Boundary Creation
 -  Delete Boundary
-  Return to Point – used to create, guide to or delete a point
 -  Mark Point
 -  Cancel Navigation
 -  Go to Point
 -  Delete Point
-  Zoom In/Out – sidebar icons increase/decrease the area displayed on the screen
-  Mark A Point – used to establish the first point in an AB guideline
-  Close Menu – used to close the Navigation and guidance options menu

Field View

Navigation and guidance options tab menu buttons

-  Home – used to access Home screen
-  Guidance Views – used to change between Vehicle view and Field view
-  Pan – used to move the displayed map area in the corresponding direction without moving the vehicle
-  Zoom In/Out – sidebar icons increase/decrease the area displayed on the screen
-  Close Menu – used to close the Navigation and guidance options menu

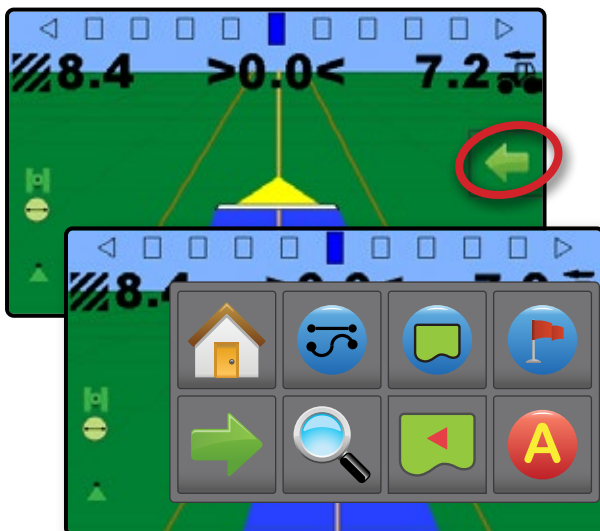
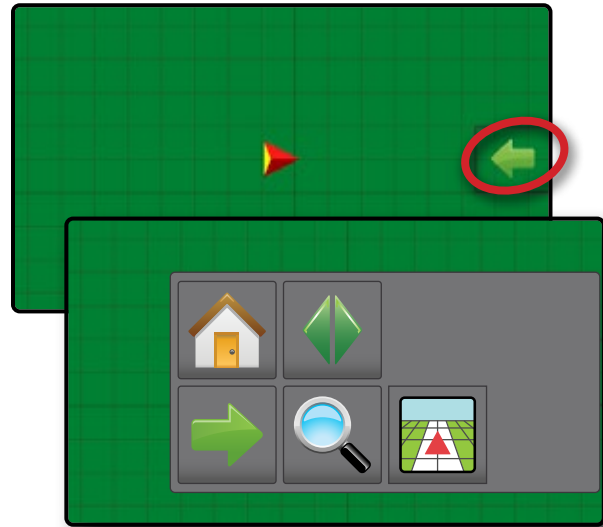

Guidance Modes

The guidance modes button is used to change the guidance mode.

To choose a guidance mode:

1. On vehicle view guidance screen, press NAVIGATION AND GUIDANCE OPTIONS tab to display navigation options.
2. Press GUIDANCE MODE button .
3. Select from:
 - ▶ Straight AB guidance
 - ▶ Last pass guidance
 - ▶ No guidance
 - ▶ Curved AB guidance
 - ▶ Circle pivot guidance
 - ▶ NextRow guidance

NOTE: Offset to adjacent guidelines will be calculated using the working width: see "Configuration -> Machine Configuration in the Configuration chapter.

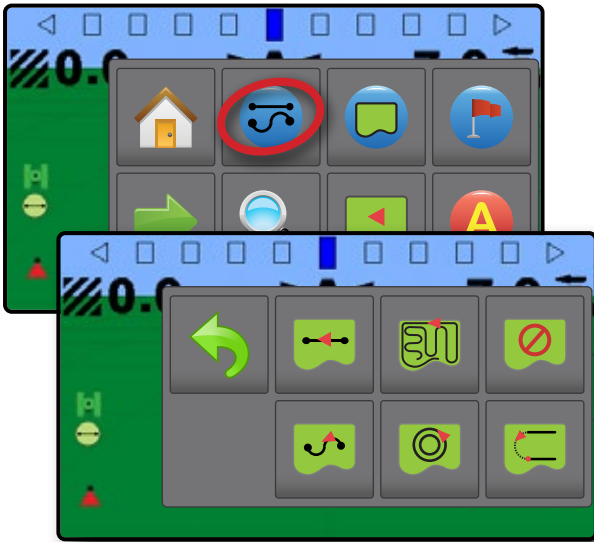

Straight AB Guidance

Straight AB guidance provides straight line guidance based on A and B reference points. The original A and B point are used to calculate all other parallel guidelines.

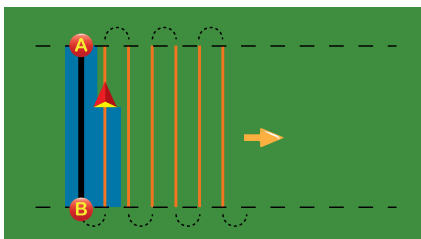

Last Pass Guidance

Last pass guidance offers true last pass navigation. The console will automatically detect the nearest applied area and establish parallel guideline based on that area.

NOTE: If a boundary is established but no application occurred during the boundary process, guidance will not initiate.

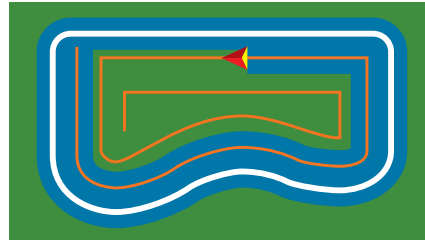

No Guidance

No guidance turns off guidance.

NOTE: No guidance mode does not delete an established guideline or point from the console. To delete established/saved data from the console, please refer to the Job Data chapter.



Curved AB Guidance

Curved AB guidance provides guidance along curved lines based on an initial AB reference line. This initial baseline is used to calculate all other guidelines.

NOTE: Curved guidance is recommended not to exceed 30° within the AB guideline.

HINT: While working in a bounded area, the guidance pattern extending beyond the established AB points will be straight line guidance.

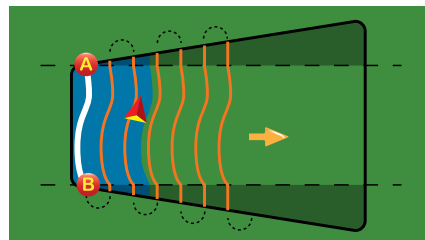

Circle Pivot Guidance

Circle pivot guidance provides guidance around a central location that radiates inward or outward based on an initial AB reference line. This initial baseline is used to calculate all other guidelines.

It is used for product application in a centre pivot field while being guided along a circular guideline that matches a centre pivot irrigation system radius.

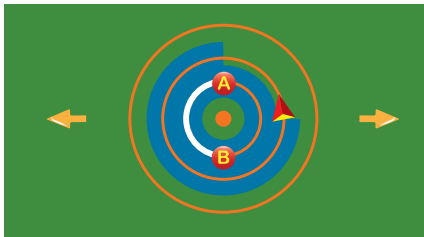

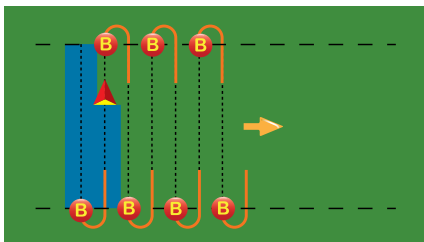

NextRow Guidance

NextRow guidance indicates where the next row is located, and provides guidance at the end of a row to the next row. When the operator marks the end of the row and begins turning to the next row, a Straight AB guidance line is provided in the next row. When the vehicle is in the next row, guidance is turned off.





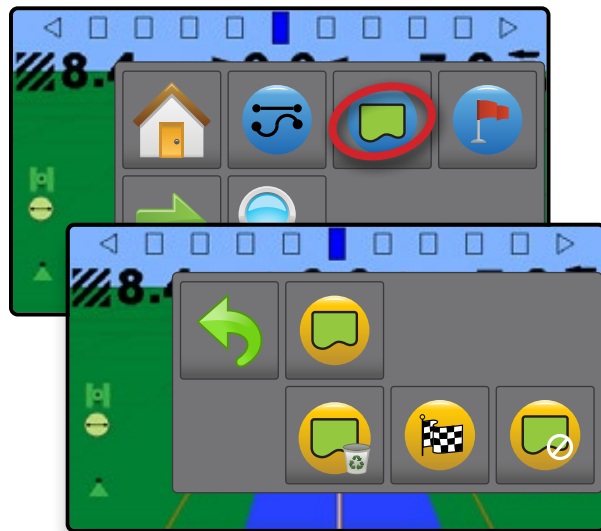

Application Boundary

Application boundaries establish areas where application is and is not to be applied. Boundaries can be established in all guidance modes. One exterior boundary can be stored at a time. In correspondence to your current location, the IN BOUNDARY icon  or OUT BOUNDARY icon  is displayed on the status bar once the boundary is established.





Creating a Boundary

To establish an application boundary:

1. Drive to a desired location at the perimeter of the field/application area.
2. On vehicle view guidance screen, press NAVIGATION AND GUIDANCE OPTIONS tab  to display navigation options.
3. Press BOUNDARY button .
4. **While the vehicle is in motion,** press BOUNDARY button .
5. Travel the perimeter of the field/area.
6. Finish boundary:
 - ▶ Travel to within one working width of the starting point. The boundary will close automatically (the white boundary line will turn dark grey)
 - ▶ Press BOUNDARY FINISH button . A straight line will complete the boundary between your current location and the starting point

NOTE: The BOUNDARY FINISH button  is not available for selection (greyed out) until the minimum distance is travelled (five-times the working width).

Use CANCEL BOUNDARY button  under Boundary  on the Navigation and guidance options  menu to cancel the new field boundary process and revert to the previous boundary (when established).

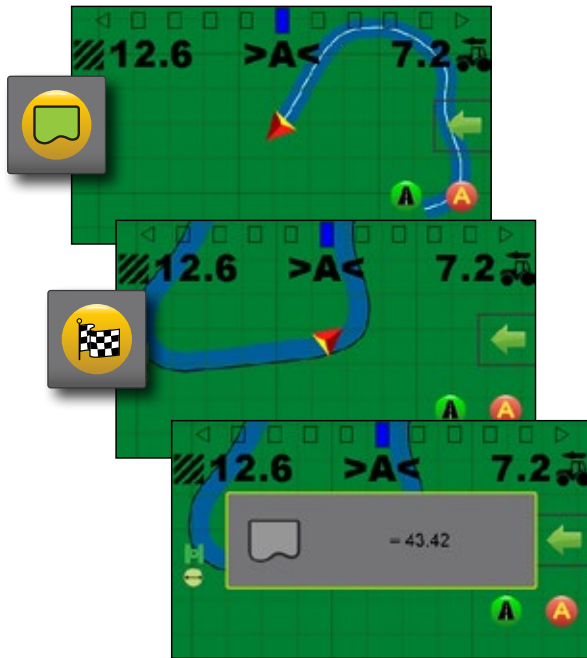

Delete the Boundary

To delete the established boundary:

1. On vehicle view guidance screen, press NAVIGATION AND GUIDANCE OPTIONS tab to display navigation options.
2. Press BOUNDARY button .
3. Press DELETE BOUNDARY button .

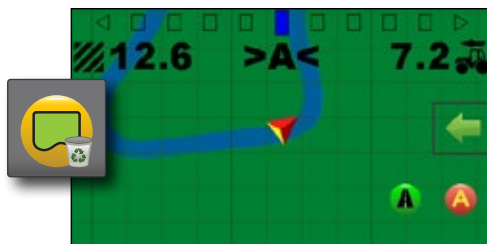

Return to Point

Return to point provides guidance back to an established point. An arrow directs the vehicle back to the established point.

A return point will remain active until deleted.

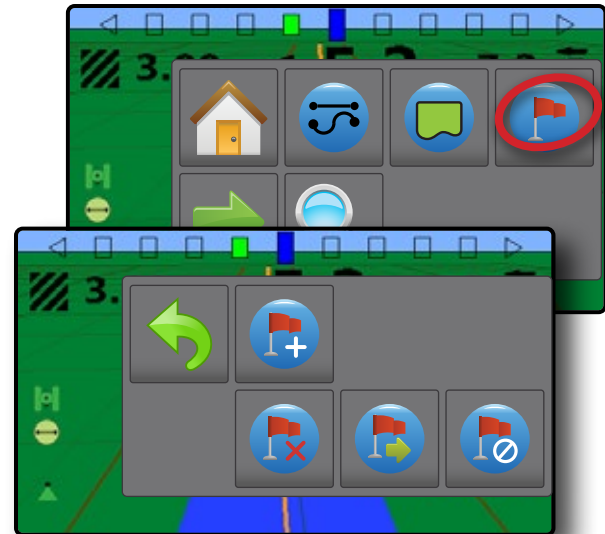

Marking a Return Point

To mark a return point:

1. Drive to the desired location of return point .
2. On vehicle view guidance screen, press NAVIGATION AND GUIDANCE OPTIONS tab to display navigation options.
3. Press RETURN TO POINT button .
4. Press ADD POINT button .

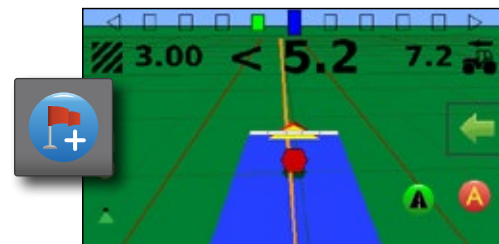

Guidance to a Return Point

To show distance and guidance to the established return point:

1. On vehicle view guidance screen, press NAVIGATION AND GUIDANCE OPTIONS tab to display navigation options.
2. Press RETURN TO POINT button .
3. Press RETURN TO POINT GUIDANCE button .

The console will begin providing the distance information on the guidance bar from the vehicle to the established point.

Use CANCEL RETURN TO POINT GUIDANCE button under Return to point on the Navigation and guidance options menu to hide distance and guidance to the established point.

Guidance cannot be calculated when “?” appears in the guidance bar.

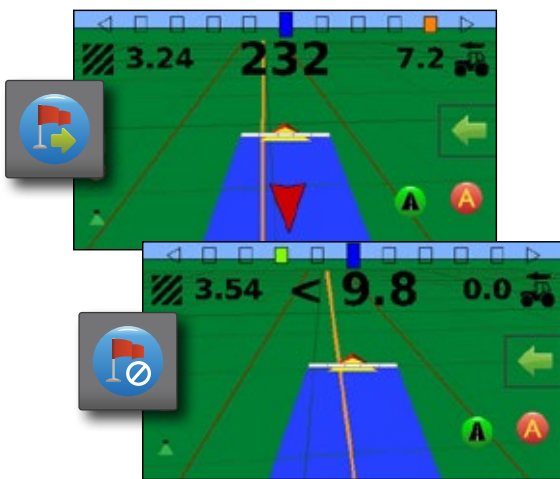

Delete the Return Point

To delete the established return point:

1. On vehicle view guidance screen, press NAVIGATION AND GUIDANCE OPTIONS tab to display navigation options.
2. Press RETURN TO POINT button .
3. Press DELETE POINT button .

Delete point button is not available while return to point guidance is active.

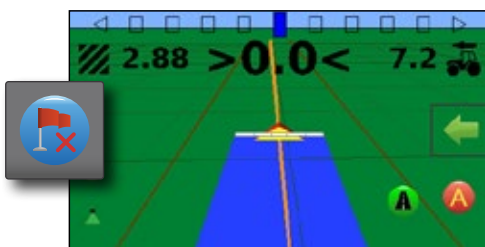

Zoom In/Out

Zoom in/out is used to adjust the map's visible area.

Vehicle View

- ▶ Zoom in will adjust view to vehicle view displaying a compass on the horizon
- ▶ Zoom out will adjust view to bird's eye view

NOTE: Press & hold PLUS/MINUS to quickly adjust settings.

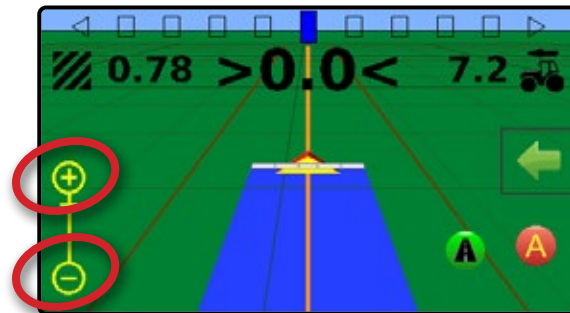

Field View

- ▶ Zoom in will decrease the amount of map area visible
- ▶ Zoom out will increase the amount of map area visible

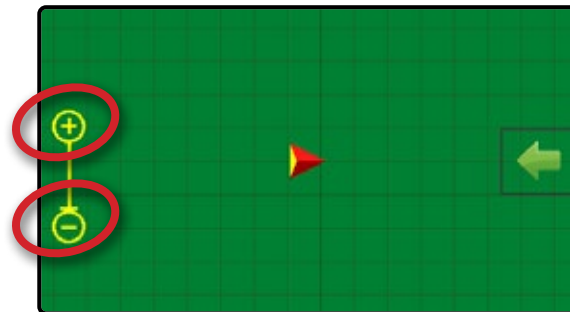

NOTE: Press & hold PLUS/MINUS to quickly adjust settings.



Pan

 While in Field view guidance, the Pan mode allows the screen to be positioned manually as desired.

To enter Pan mode and pan across the screen:

1. On field view guidance screen, press NAVIGATION AND GUIDANCE OPTIONS tab  to display navigation options.
2. Press PAN button .
3. Press:
 - ▶ AND DRAG SCREEN in the corresponding direction to move the view on screen (only available if application has been applied).
 - ▶ ARROWS in the corresponding direction to move the view on screen (down, left, right, up).

NOTE: Press & hold ARROWS to quickly adjust settings.

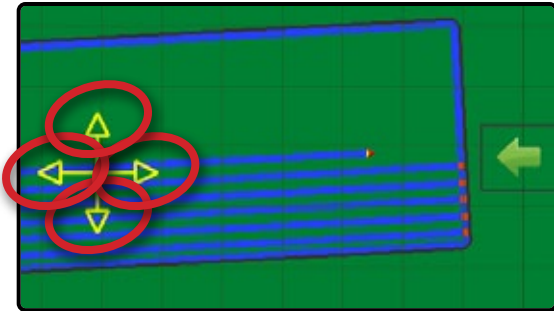



APPLICATION MAPPING & APPLIED ALERT

Application mapping is used to map coverage areas and flash and sound alerts when entering and existing previously mapped applied areas to alert the operator to turn on or shut off application.

NOTE: Application mapping does not control actual application.

Mapping with Console Only

To switch mapping and alerts off or on using the console:

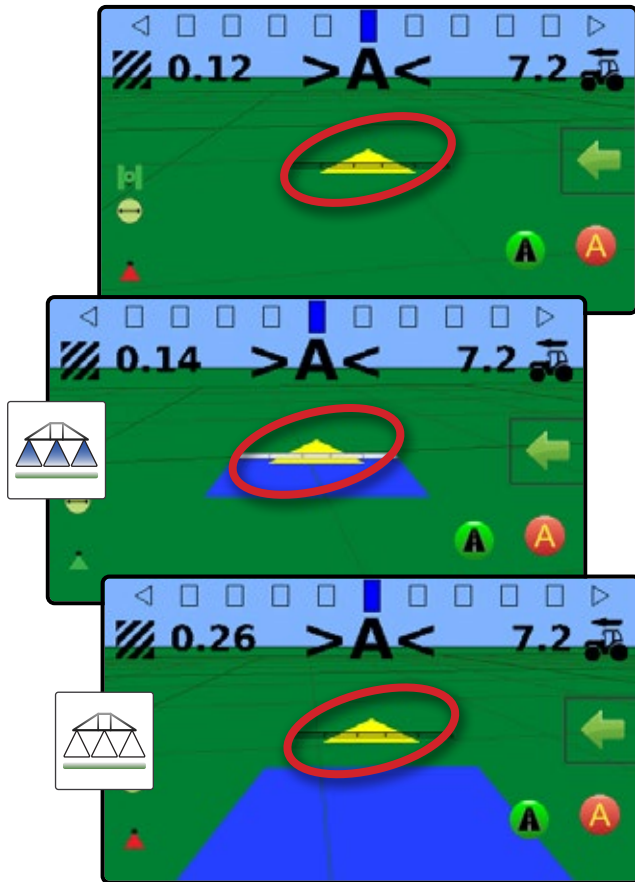

1. Press vehicle  in the centre of the screen.
 - ◀ Mapping and alerts on – status bar icon will change to green 
 - ◀ Mapping and alerts off – status bar icon will change to red 





Mapping with Work On/Off Switch

When installed, the work on/off switch should remain in the “off” position for all setup options.

To switch mapping and alerts off or on using the switch:

1. Turn the switch to the “On” or “Off” position.
 - ◀ Mapping and alerts on – status bar icon will change to green 
 - ◀ Mapping and alerts off – status bar icon will change to red 

To switch mapping and alerts off or on using the console while a switch is attached:

1. Turn the switch to the “Off” position.
2. Press vehicle  in the centre of the screen.
 - ◀ Mapping and alerts on – status bar icon will change to green 
 - ◀ Mapping and alerts off – status bar icon will change to red 

Applied Alert

When entering or exiting an applied area, an audio alert will sound and section indicators will flash as each section needs to be turned on/off.

- ◀ Two beeps – entering an applied area; section mapping will turn off
- ◀ One beep – exiting an applied area; section mapping will turn on

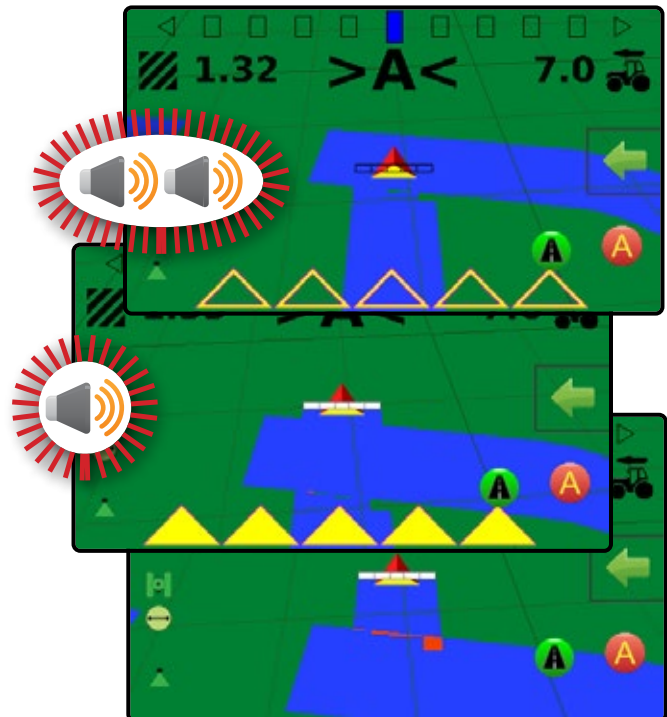

CHAPTER 3 – CONFIGURATION



Used to select, setup and manage the machine configurations, field configurations and GNSS receiver.

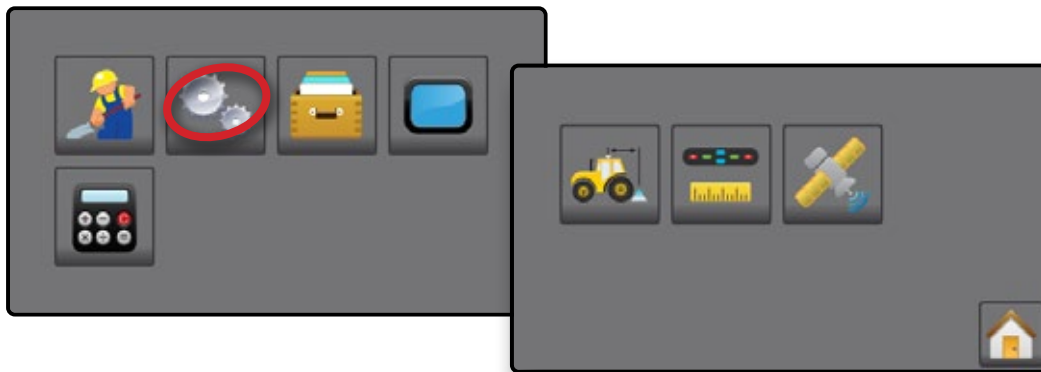

Machine Configuration

Machine configuration menu is used to create and manage up to five (5) individual machine profiles representing the configuration of the console on a particular vehicle/equipment setup. Each machine profile records the settings in use at the time the profile is generated allowing the customer to recall their exact setup for later use.

1. From the Home screen, press CONFIGURATION button .
2. Press MACHINE CONFIGURATION button .
3. Configure each option in the following order. Press current value then use the keyboard to enter a new value or select an option from the list provided.

- ▶ Machine Profile Number **1** – used to select one of five (5) machine profiles. The profile that is “active” is displayed/active on the operation screen.
- ▶ Number of Implement Sections **2** – used to select the number of implement sections. Range is 1 to 7 sections.
- ▶ Section Widths **3** – used to enter the width of each section. Each section can be a different width. Range for each section is 1.0 to 246.1 feet / 0.30 to 75.0 metres. Total for all sections must be greater than 1.0 foot / 0.3 metres.

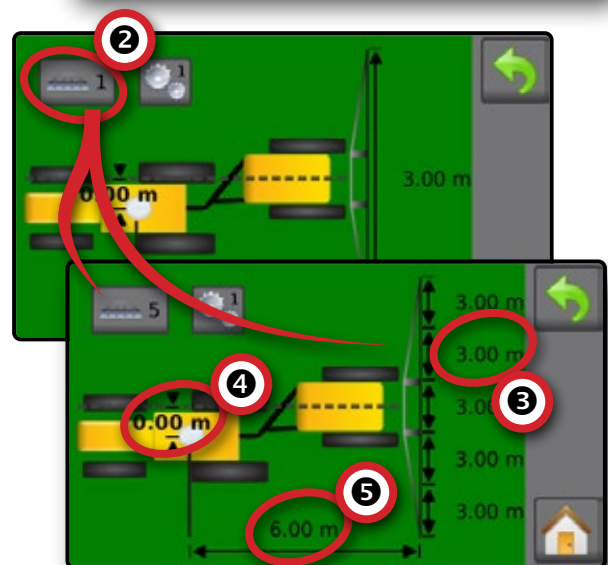
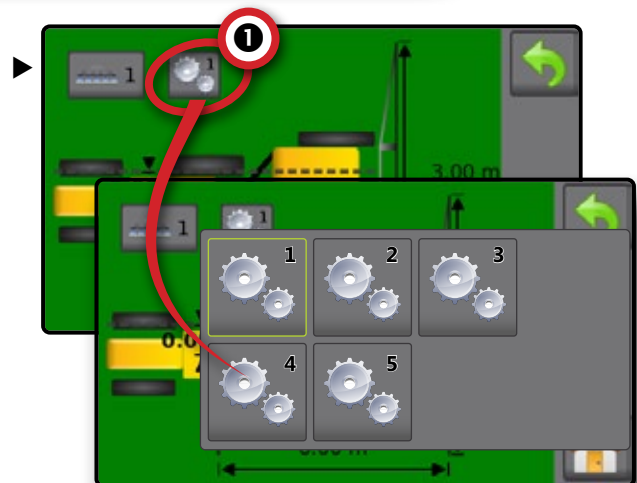

► Lateral implement offset distance **4** – used to define the lateral distance from the centre line of the machine to the centre of the implement. Range is 0.0 to +/-16.4 feet / 0.0 to +/-5.0 metres.

◀ Positive Offset Value – moves the implement to the right of centre while facing in the machine's forward direction.

◀ Negative Offset Value – moves the implement to the left of centre while facing in the machine's forward direction.

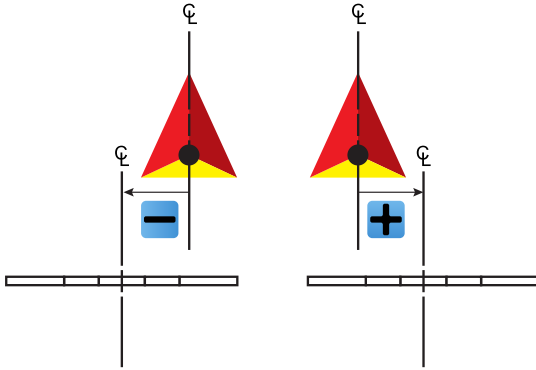

► In-Line Implement Offset Distance **5** – used to define the in-line distance from the GNSS antenna to the implement. The GNSS antenna is always the zero (0) point. Range is -32.8 to +65.6 feet / -10.0 to +20.0 metres.

◀ Positive Offset Value – moves the implement behind the GNSS antenna.

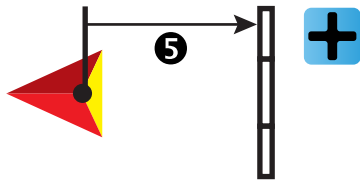

◀ Negative Offset Value – moves the implement in front of the GNSS antenna.

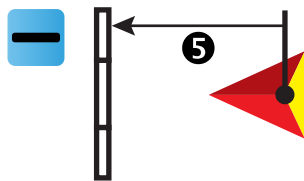

Working Width

The total width for all sections is used to determine the working width. The working width is used to determine the automatic finish point of a boundary.

Lightbar Spacing

Lightbar spacing is used to set the distance away from the guideline or vehicle each guidance screen lightbar box represents.

1. From the Home screen, press CONFIGURATION button
2. Press LIGHTBAR SPACING button
3. Press current value and use the keyboard to enter a new value.

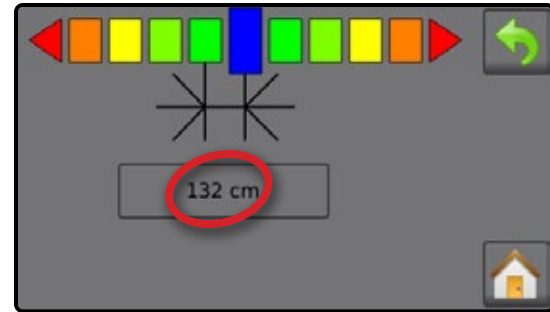

GNSS Receiver Configuration

GNSS receiver configuration is used to select the GNSS receiver requirements.

1. From the Home screen, press CONFIGURATION button
2. Press GNSS button
3. Select the required configuration:
 - Use SBAS **1** – used to select if any satellite-based differential correction system (SBAS) will be used.
 - Select Minimum Position Quality Requirement **2** – used to select between using ClearPath® and SBAS, or SBAS only. If "Use SBAS" is not selected, ClearPath is required (indicated by a grey selection dot).
 - Select Additional Constellations **3** – used to Indicated when the GLONASS or QZSS uncorrected signals are available.

GPS uncorrected signals from the GPS system are always available and cannot be disabled.

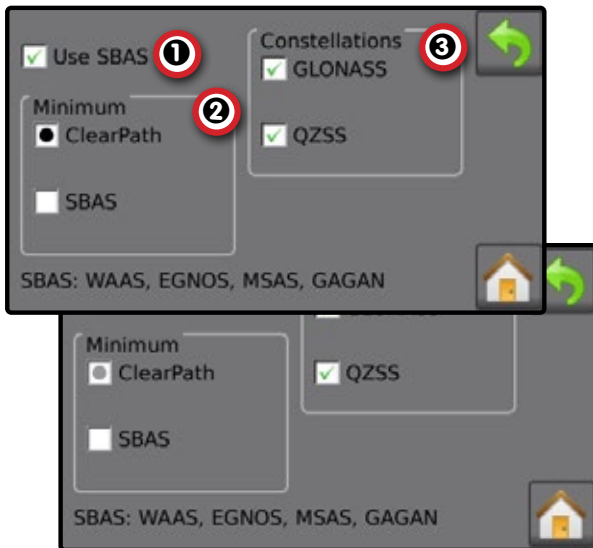

NOTE: When using the Matrix 430 in Europe, always include GLONASS. Use SBAS (EGNOS) where applicable.

Not Acceptable GNSS Notification

If GNSS receiver is set to use SBAS and SBAS signal quality is not acceptable, or if GPS quality is not acceptable, a warning will be shown.

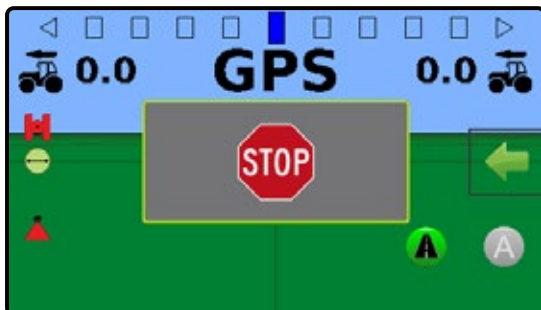

CHAPTER 4 – JOB DATA



One of up to five (5) jobs may be selected to view job information.
The current job, displayed/active on the Guidance screen, may be exported as a report.



Job Data Overview

Job information includes:

- ◀ Active Job Number
- ◀ Total Applied Area
- ◀ Bounded Area

NOTE: Bounded area is only shown when a boundary is active.

- ◀ Application Time

1. From the Home screen, press DATA button .
2. Press **Job Number** to view information for a different job.
 - ◀ Enter a different number (1-5) to display another job.
3. Select ACCEPT icon or CANCEL icon accordingly.

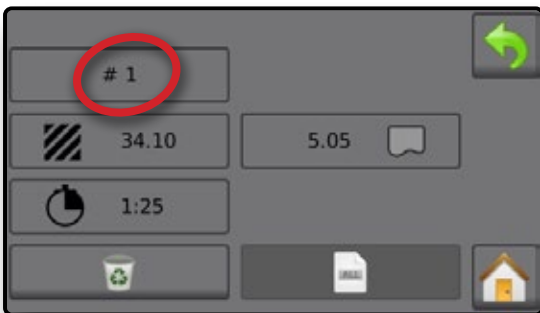

Delete Job Data



To delete job information from the current job number:

1. Press DATA button .
2. Verify the current job number is the job intended to be deleted.
3. Press RECYCLE button .
4. Select ACCEPT icon or CANCEL icon accordingly.



Reports

To save reports to a USB drive:

1. Press DATA button .
2. Insert USB drive.
3. Press SAVE ALL button .

NOTE: If no data has been collected, the SAVE ALL button will be unavailable (greyed out).

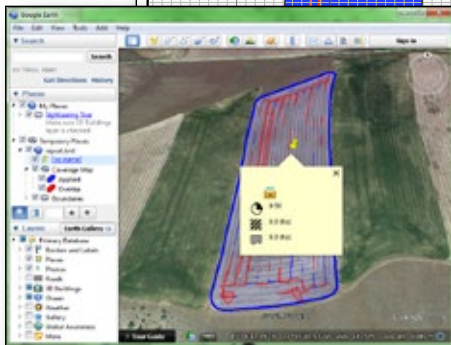
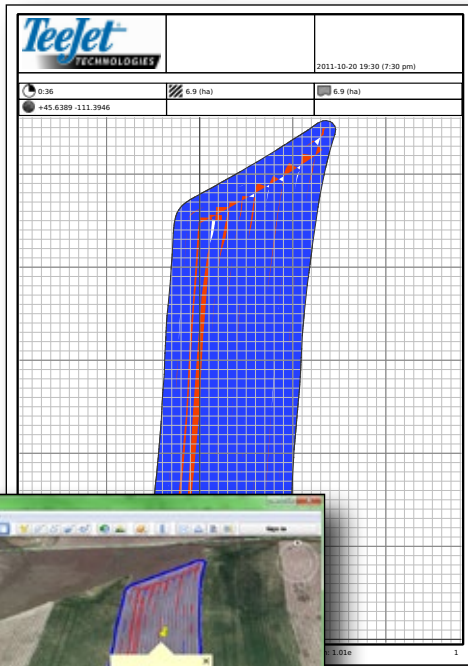
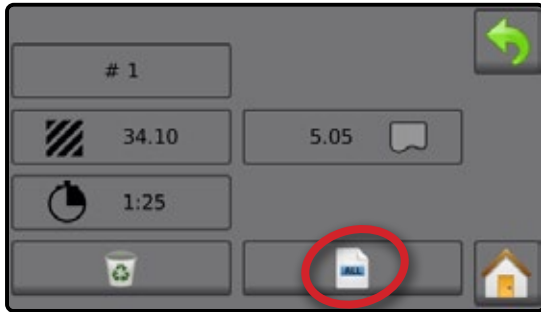

Memory Notifications

The console has a limited amount of storage space to retain job information. If job data files become too large, usually due to extremely large amounts of applied area data, a memory almost full notification then a memory full warning will be displayed.

To clear this warning, at least one job must be deleted.

Figure 1: Memory Almost Full Notification



Figure 2: Memory Full Warning

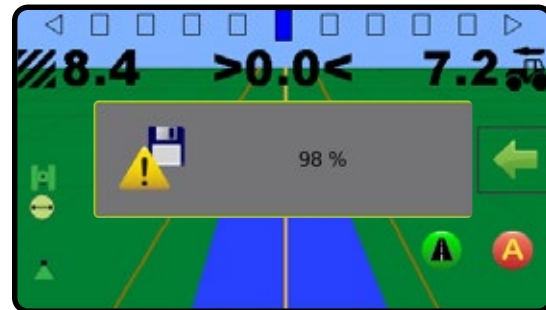











CHAPTER 5 – CONSOLE



The Console setup is used to configure the display and cultural settings.



1. From the Home screen, press CONSOLE button .
2. Select from:
 - ▶ LCD Brightness  – used to adjust the brightness of the console display
 - ▶ Colour Scheme  – used to change the background and text colours on the display
 - ▶ Units  – used to define the system measurements
 - ▶ Demonstration Mode  – used to start playback of simulated GNSS data
 - ◀ GNSS  – press to use real GNSS signals
 - ◀ Demo  – press to start demonstration GNSS
 - ▶ Screenshot  – used to allow screen captures to be saved to a USB drive
 - ▶ Time Zone  – used to establish the local time zone
 - ▶ About  – used to display the system software version.
 - ◀ To help troubleshoot problems in the field, press TXT button  to download a text file containing current software information to a USB drive, then e-mail the file to support personnel.

MATRIX® 430

SOFTWARE DOWNLOAD UPDATE

As TeeJet Technologies continues to enhance its software, updates for the console will be made available at www.teejet.com. You must have the software update folder stored on a USB storage device prior to beginning the update.

RECOMMENDATION: Be parked while the update is in progress. This will help ensure that the update process is not interrupted by the USB drive bouncing around while the vehicle is in motion.

NOTE: The file is in a compressed zip format and needs to be unzipped/uncompressed before loading onto the USB drive.

To update the console:

1. Download the zip file directly to your computer's Desktop or Downloads folder.
2. Double click the zip file then select either A or B:
 - A) Copy and paste the "tjrun" folder to the root directory of an empty USB drive.
 - B) Using the "Extract all files" function, unzip/uncompress the downloaded file to the root directory of an empty USB drive.

Once downloaded and unzipped, you will see the folder "tjrun" on your USB drive.
3. Properly eject the USB drive from your computer using the "Safely Remove Hardware" icon from the Task Bar or the "Eject this disk" function from the My Computer window or the "Eject Disk" option (on a MAC).
4. With the console ON, lift rubber cover and insert the USB drive into the console.

WARNING!: Do not remove the USB drive or disconnect power from the console at any time during the update process.

The update will start automatically. A series of screens will cycle informing of the progress.

5. Once instructed, remove the USB drive.
6. Reboot the console.



USB Port
with Rubber Cover

MATRIX® 430

To verify your update has installed, check the version number on the screen.

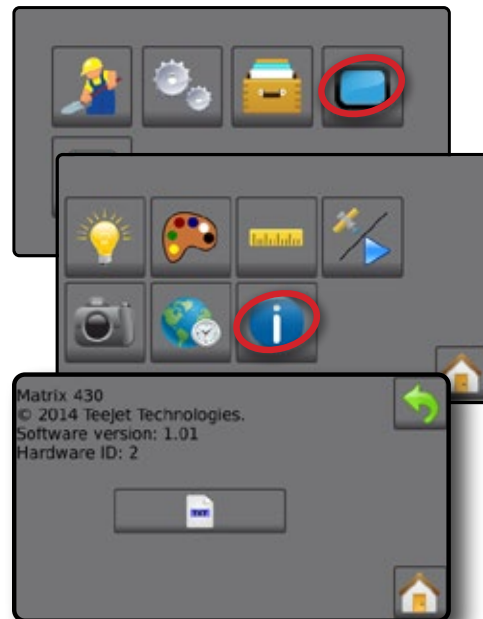

NOTES:

- ▶ The software update file can be used on multiple consoles.
- ▶ The console should retain all previous programmed settings.
- ▶ Before using the USB drive for data storage, the update folder must be removed from the USB drive.

WARNING!: Do not use a USB storage device with U3 technology (also known as "U3 smart drives") as U3 technology could cause downloading or job storage issues.

Please contact TeeJet Technologies with any questions or for assistance.

TEEJET TECHNOLOGIES IS NOT RESPONSIBLE FOR DAMAGE DUE TO IMPROPER DOWNLOAD AND INSTALLATION OF AN UPDATE

MATRIX® 430

USER MANUAL



A Subsidiary of  *Spraying Systems Co.*

www.teejet.com