

# FieldPilot<sup>®</sup> Pro & UniPilot<sup>®</sup> Pro

## USER MANUAL

Assisted/Automatic Steering Controller

For use with Aeros or Matrix Pro GS consoles Software v4.21

SCM Pro Software Version 3.2.32197



A Subsidiary of  Spraying Systems Co.<sup>®</sup>

**Copyrights**

© 2016 TeeJet Technologies. All rights reserved. No part of this document or the computer programmes described in it may be reproduced, copied, photocopied, translated, or reduced in any form or by any means, electronic or machine readable, recording or otherwise, without prior written consent from TeeJet Technologies.

**Trademarks**

Unless otherwise noted, all other brand or product names are trademarks or registered trademarks of their respective companies or organizations.

**Limitation of Liability**

TEEJET TECHNOLOGIES PROVIDES THIS MATERIAL "AS IS" WITHOUT WARRANTY OF ANY KIND, EITHER EXPRESSED OR IMPLIED. NO COPYRIGHT LIABILITY OR PATENT IS ASSUMED. IN NO EVENT SHALL TEEJET TECHNOLOGIES BE LIABLE FOR ANY LOSS OF BUSINESS, LOSS OF PROFIT, LOSS OF USE OR DATA, INTERRUPTION OF BUSINESS, OR FOR INDIRECT, SPECIAL, INCIDENTAL, OR CONSEQUENTIAL DAMAGES OF ANY KIND, EVEN IF TEEJET TECHNOLOGIES HAS BEEN ADVISED OF SUCH DAMAGES ARISING FROM TEEJET TECHNOLOGIES SOFTWARE.

## Table of contents

<b>IMPORTANT INFORMATION</b>	<b>V</b>
<b>LEGAL DISCLAIMER</b>	<b>V</b>
<b>SAFETY INFORMATION</b>	<b>VI</b>
<b>CHAPTER 1 – SYSTEM OVERVIEW</b>	<b>1</b>
Features.....	1
FieldPilot Pro Kit or UniPilot Pro Kit.....	1
SCM Pro Device.....	2
SCM Pro LED Indicators.....	2
FieldPilot Pro or UniPilot Pro Connections.....	3
GNSS Receiver Connections.....	4
Vehicle Connections.....	4
Accessories Connections.....	4
<b>GNSS IS REQUIRED</b>	<b>4</b>
<b>UNLOCK FIELDPILOT PRO / UNIPILOT PRO</b>	<b>5</b>
<b>PUBLIC LIABILITY DISCLAIMER NOTICE</b>	<b>6</b>
<b>CHAPTER 2 – SETUP MENU OPERATION</b>	<b>7</b>
Accessing FieldPilot Pro or UniPilot Pro Setup Menu.....	7
<b>SELECT QI VALUES</b>	<b>8</b>
<b>MANAGE VEHICLES</b>	<b>9</b>
Active Vehicle.....	9
New Vehicle Profile.....	10
Edit Vehicle Profile.....	11
Vehicle Profile Options.....	12
Vehicle Name.....	12
Vehicle Type.....	12
Vehicle Make.....	12
Vehicle Model.....	12
Controller Type.....	12
Wheel Base.....	13
Antenna In-line Offset Direction & Distance.....	13
Antenna Lateral Offset Direction & Distance.....	13
Antenna Height.....	14
SCM Pro In-line Offset Direction & Distance.....	14
SCM Pro Lateral Offset Direction & Distance.....	15
SCM Pro Height.....	15
Wheel Angle Sensor (WAS).....	15
SCM Pro Orientation.....	15

Manual Disengage .....	16
Pressure Graph.....	16
Saved.....	16
Current.....	16
Start .....	17
Session Manual Steering Override Threshold .....	17
Up/Down Buttons.....	17
Save Limit .....	17
Automatic Calibration.....	18
Compass Calibration .....	19
Compass Calibration Errors.....	20
Wait for Heading .....	20
Tilt Zero Calibration.....	20
Initial Direction .....	21
Opposite Direction .....	21
Tilt Calibration Errors .....	22
Valve Deadband .....	22
Angle Sensor .....	22
Valve.....	23
UniPilot Pro Deadband.....	24
UniPilot Pro.....	24
Antenna Lateral Offset Distance Adjustment.....	25
Vehicle Adjust .....	26
Vehicle Adjust Options .....	27
Steering Response.....	27
Heading Aggressiveness .....	27
Cross Track Error.....	27
Line Acquisition .....	27

---

## **CHAPTER 3 – FIELDPILOT PRO OR UNIPILOT PRO ON GUIDANCE SCREENS** **28**

Assisted/Auto Steering Status .....	28
-------------------------------------	----

---

## **APPENDIX** **29**

Orthogonal Orientations .....	29
Vehicle Profile Worksheet .....	30
Transferring SCM Pro from One Vehicle to Another.....	31
Tools Required .....	31
Installing the SCM Pro on to a Vehicle.....	32
Display Connections.....	32

## IMPORTANT INFORMATION

Refer to your vehicle specific hardware installation manual for complete installation requirements before operating the FieldPilot Pro system or UniPilot Pro system.

There are no serviceable parts inside FieldPilot Pro system or UniPilot Pro system. Do not open the unit. Opening the unit will void the warranty.

Retain this User Manual in safe place for future reference.

### Life Support Policy and Use in Safety-Critical Compliance

Products are not authorized for use in life-support or safety-critical applications. Use in such applications is done at the sole discretion of the customer. Manufacturer will not warrant the use of its devices in such applications.

### About this Manual

While every effort has been taken to ensure the accuracy of the contents of this manual, the manufacturer cannot accept responsibility for any errors or omissions. This manual is based on FieldPilot Pro system or UniPilot Pro system software version 2.4. In case of differences between the manual and the product, use the information from the product.

### Product and Serial Numbers

Please record the product and serial numbers of your FieldPilot Pro system or UniPilot Pro system in the space below:

Product Number (PN): \_\_\_\_\_

Serial Number (SN): \_\_\_\_\_

The product number and serial numbers are located on a right side of the unit. Keep these numbers handy when contacting Technical Support.

### Technical Support

Contact your dealer for technical support.

## LEGAL DISCLAIMER

*NOTE: Read and follow ALL instructions in this manual carefully before installing or operating the FieldPilot Pro system or UniPilot Pro system.*

*NOTE: Take careful note of the safety information in the Safety Information section of this manual and the additional safety messages provided throughout this and any other supplemental manuals provided.*

The manufacturer disclaims any liability for damage or injury that results from the failure to follow the instructions, cautions, and warnings set forth herein.

Please take special note of the following warnings:

1. There is NO obstacle avoidance system included with the manufacturer's product. The owner must always have a human present in the operator's seat of the vehicle when the FieldPilot Pro system or UniPilot Pro system is in use to look for any obstacles to avoid including people, animals, trees, power poles, ditches, buildings, etc. and take control of the vehicle to manually avoid them if necessary.
2. The FieldPilot Pro system or UniPilot Pro system does NOT control the speed of the vehicle. The operator must always adjust the speed of the vehicle manually so that it is operated at a safe speed that will not cause the vehicle to roll over or go out of control.
3. The FieldPilot Pro system or UniPilot Pro system will take over control of the vehicle's steering system when the FieldPilot Pro system or UniPilot Pro system is activated during testing, calibration, tuning, and automatic steering operations. The vehicle's steering axles, tracks, articulation point, or wheels may move unpredictably when activated. Prior to starting the vehicle and/or activating the FieldPilot Pro system or UniPilot Pro system, verify that all people and obstacles are clear of the vehicle to prevent death, injury, or damage to property.
4. Use of the FieldPilot Pro system or UniPilot Pro system is NOT permitted while the vehicle is on public roads or in public areas. Verify that the system is powered OFF before driving on roads or in public areas.

## SAFETY INFORMATION



### Warning Alerts

The FieldPilot Pro system or UniPilot Pro system installer and manufacturer disclaim any responsibility for damage or physical harm caused by failure to adhere to the following safety requirements:

- As the operator of the vehicle, you are responsible for its safe operation.
- The FieldPilot Pro system or UniPilot Pro system is not designed to replace the vehicle's operator.

*NOTE: Prior to operating the FieldPilot Pro system or UniPilot Pro system, verify that all the screws, bolts, nuts, and harness connections are tight and that all the cables and hoses have been secured to prevent them from being damaged. Verify there are no oil leaks in the steering circuit.*

*WARNING! To understand the potential hazards associated with the operation of an FieldPilot Pro system or UniPilot Pro system equipped vehicle, read the provided documentation prior to installing or operating the FieldPilot Pro system or UniPilot Pro system on a vehicle.*

*WARNING! To prevent accidental death or injury from being run over by the vehicle, never leave the vehicle's operator seat with the FieldPilot Pro system or UniPilot Pro system engaged.*

*WARNING! To prevent accidental death or injury from being run over by the vehicle, verify that area around the vehicle is clear of people and obstacles before startup, calibration, tuning, or use of the FieldPilot Pro system or UniPilot Pro system.*

*WARNING! To prevent the accidental engagement of the FieldPilot Pro system or UniPilot Pro system and loss of vehicle control, power down the FieldPilot Pro system or UniPilot Pro system while driving on roads. Never drive on roads or in public areas with the FieldPilot Pro system or UniPilot Pro system powered up.*

*WARNING! Verify that you are in a stable position on the vehicle's platform or stairs when installing or removing the antenna assembly on top of the cab so you do not fall. If the vehicle does not provide a safe platform, use a ladder to safely access the vehicle's roof.*

*WARNING! To avoid electrical shock hazards, remove the antennas from the vehicle before driving under low structures or low electrical power lines.*

*WARNING! High-Pressure Fluid Hazard – If the installation requires working on the hydraulic system on the vehicle, read and understand the hydraulic sections of the vehicle manufacturer's operators manual before starting the installation. Wear hand and eye protection while performing hydraulic system maintenance. Relieve hydraulic system pressure before servicing the hydraulic system.*

*WARNING! If the vehicle has a wheel angle sensor as part of the installation, always shut off the vehicle when working around the wheel angle sensor while installing, checking, and adjusting the wheel angle sensor and rod lengths. The steering mechanism could move suddenly and cause severe injury or death.*



### Caution Alerts

The FieldPilot Pro system or UniPilot Pro system installer and manufacturer disclaim any responsibility for damage or physical harm caused by the failure to adhere to the following safety requirements:

*CAUTION! The FieldPilot Pro system or UniPilot Pro system does not detect obstacles in the vehicle's path. The vehicle operator must observe the path being driven and take over steering manually if an obstacle must be avoided.*

*CAUTION! The FieldPilot Pro system or UniPilot Pro system does not control the speed of the vehicle. The operator must manually adjust the speed of the vehicle to keep the vehicle safely under control.*

*CAUTION! The FieldPilot Pro system or UniPilot Pro system must be powered OFF when installing or removing the FieldPilot Pro system or UniPilot Pro system, or any other components connected to the FieldPilot Pro system or UniPilot Pro system.*

## CHAPTER 1 – SYSTEM OVERVIEW

The FieldPilot Pro system or UniPilot Pro system is a high precision electronic controller that provides automatic steering capability to the vehicle. The FieldPilot Pro system or UniPilot Pro system receives guidance information from the Aeros or Matrix Pro GS systems and sends steering commands to the vehicle. This User Manual provides information on how to setup, configure, and manage the various settings on the FieldPilot Pro system or UniPilot Pro system and how to navigate through the software menus.

The FieldPilot Pro system or UniPilot Pro system is compatible with an Aeros or Matrix Pro GS system. For information about setting up farms, fields, jobs, guidance patterns, and other Aeros or Matrix Pro GS related functions, please refer to the Aeros User Manual or Matrix Pro GS User Manual.

The FieldPilot Pro system or UniPilot Pro system can be installed easily on most agricultural vehicle makes and models. This chapter provides basic information on how the FieldPilot Pro system or UniPilot Pro system components are organized and installed. Refer to the Vehicle Installation Manual that comes with the vehicle installation kit for more details on the complete installation of the FieldPilot Pro system or UniPilot Pro system.

### Features

The FieldPilot Pro system or UniPilot Pro system is designed to be compatible with many makes and models of vehicles available in today's agricultural market. The FieldPilot Pro system or UniPilot Pro system can be installed on most agricultural platforms including articulated tractors, combines, MFWDs, and standard front axle tractors, floaters, sprayers, swathers, track tractors, and others from most manufacturers including AGCO, Ag Chem, Case, Challenger, Fendt, John Deere, New Holland, Massey Ferguson, and many others. The same operator interface can be used on all vehicles, regardless of the make or model, making it easy for drivers to become familiar with the controls even if the system is installed on multiple vehicle types.

FieldPilot Pro or UniPilot Pro features include:

- Automatic precision steering for agriculture vehicles
- Support for most vehicle controller types: mechanical, hydraulic, steer-by-wire, and factory steer ready
- Support for various GNSS receivers that provide NMEA messages
- Roll, pitch and GNSS antenna lateral offset corrected NMEA position messages output for additional devices
- High level of accuracy with cm-level (sub-inch) repeatability with compatible GNSS RTK receivers
- High precision 9-axis inertial sensors to provide enhanced terrain compensation and high accuracy
- Support for Ethernet wired or WiFi wireless connection for troubleshooting and technical assistance

### FieldPilot Pro Kit or UniPilot Pro Kit

The main FieldPilot Pro kit or UniPilot Pro kit components are listed below.

Table 1: FieldPilot Pro Kit

Part #	Description
78-08098 78-08095	SCM Pro (Steering Control Module)
45-10172	SCM Pro Main Harness
98-05341	FieldPilot Pro / UniPilot Pro User Manual

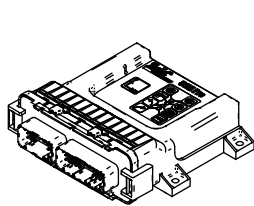

SCM Pro (Steering Control Module)

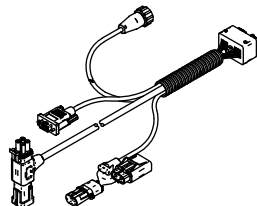

SCM Pro Main Harness

Table 2: UniPilot Pro Kit

Part #	Description
78-08097	SCM Pro (Steering Control Module)
45-10172	SCM Pro Main Harness
91-05023	Electric Steering Device, UniPilot Pro
91-05024	Switch Kit, UniPilot Pro
65-05246	UniPilot Pro Anti-rotation Bracket Kit
65-05250	Assy. Anti-Rotation Pin UniPilot Pro
98-05341	FieldPilot Pro / UniPilot Pro User Manual
98-05342	UniPilot Pro Installation Guide

## SCM Pro Device

This section describes the SCM Pro device.

Figure 1: SCM Pro Top and Bottom Views

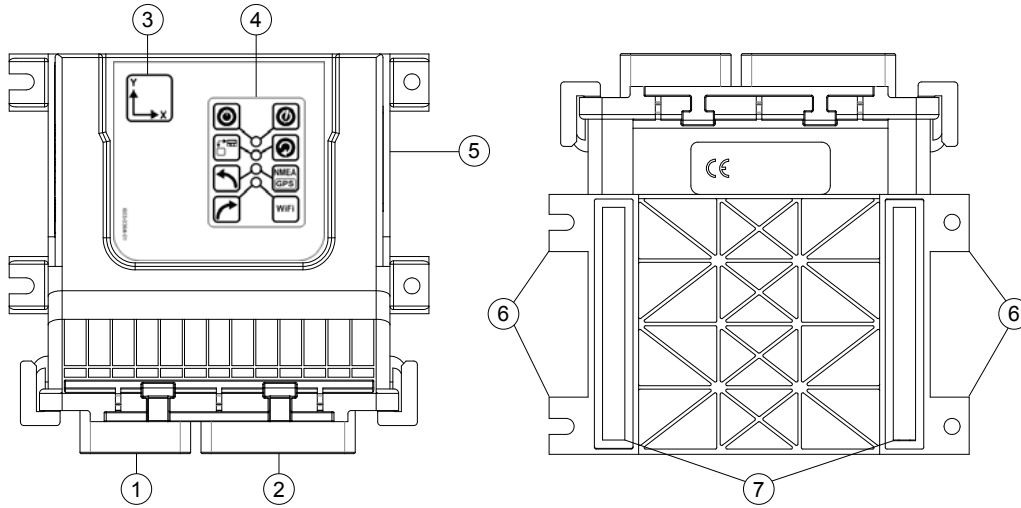

Table 1: SCM Pro Device Description

Item	Description
1	SCM Pro Main Harness connector
2	Vehicle Specific Harness connector
3	Unit orientation label
4	LED indicators panel
5	Product and serial number label (on the side)
6	Mounting tabs
7	Heat sink pads

**NOTE:** For proper operation, the heat sink pads of the SCM Pro (Steering Control Module) must be firmly attached to a metal plate. The metal mounting plate must be firmly attached to the vehicle to avoid vibrations. Verify the unit is secured with the four mounting screws before using the FieldPilot Pro or UniPilot Pro. Keep magnetic and electromagnetic devices away from the FieldPilot Pro system or UniPilot Pro system. Mounting the FieldPilot Pro system or UniPilot Pro system in areas of high vibration can adversely affect the system operation. It is highly recommended to mount directly to the vehicle's main frame or to something directly connected to the main frame.

## SCM Pro LED Indicators

The SCM Pro is equipped with four dual-color LEDs that can be used to determine the status of the FieldPilot Pro system or UniPilot Pro system as well as provide some basic troubleshooting information. Each LED can be off, green, amber, or blinking between amber and green at the same time.

Figure 2: LED Panel

<p>Solid Green - SCM Pro Power On Off - SCM Pro Power Off</p>		<p>Flashing Amber - Power supply issue or system boot error</p>
<p>Flashing Green - Display Communication active (wired connection only) Off - No Display Communication</p>		<p>Flashing or Solid Amber - Software Upgrade in progress</p>
<p>Flashing Green - Left turn command sent to the steering controller device</p>		<p>Flashing Amber - Receiving GNSS NMEA data from external receiver or Display</p>
<p>Flashing Green - Right turn command sent to the steering controller device</p>		<p>Flashing Amber - WiFi communication active</p>



## FieldPilot Pro or UniPilot Pro Connections

The FieldPilot Pro system or UniPilot Pro system requires connections to a power source, Display, GNSS receiver, and a vehicle. Additionally it can be connected to optional accessories and devices. There are various ways these devices can be attached to the SCM Pro. A few generic connections are described in the following sections. For more information on connections please refer to the Installation Manuals that are provided with those components.

Figure 3: SCM Pro Connections

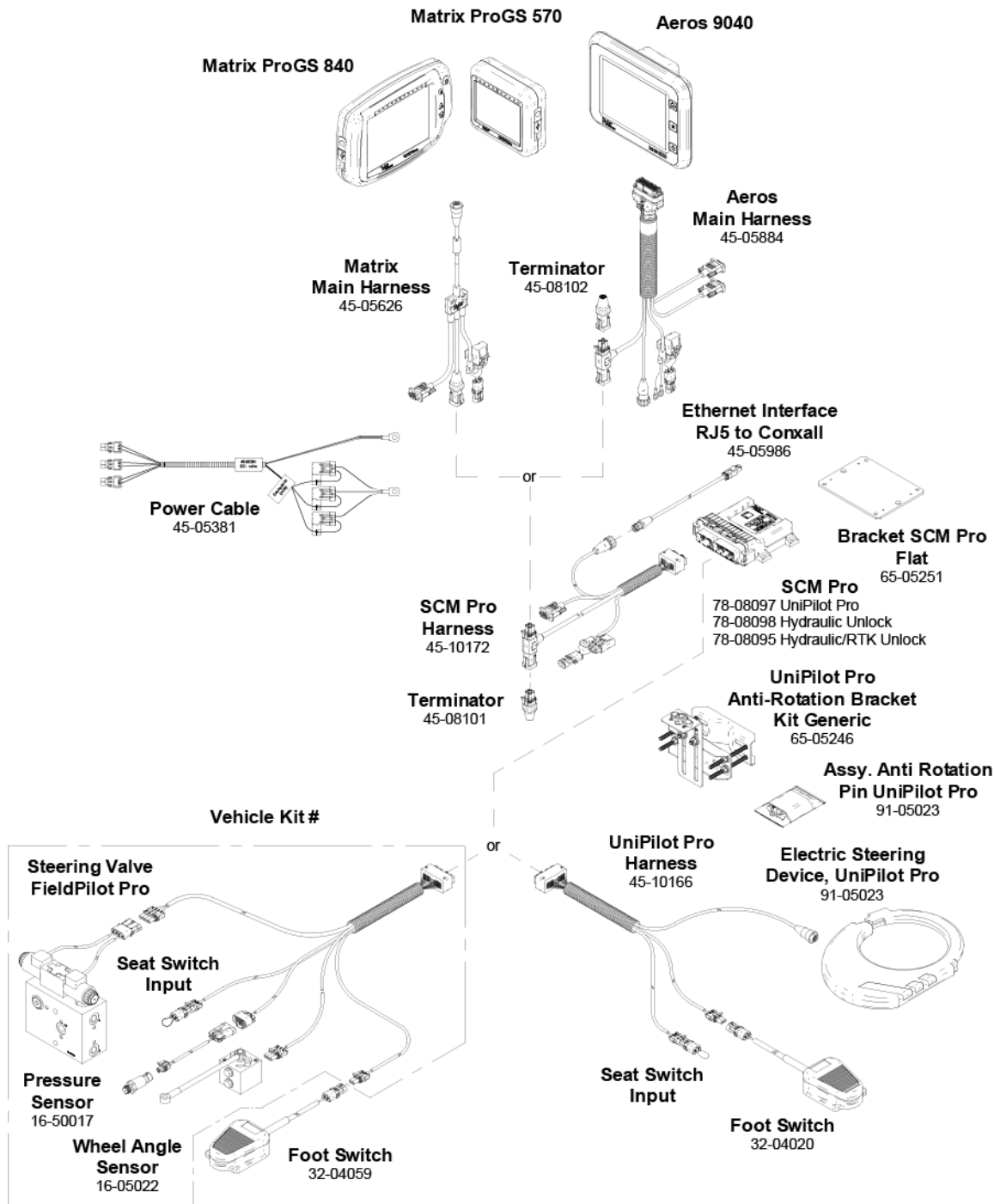

## GNSS Receiver Connections

The FieldPilot Pro system or UniPilot Pro system requires the position information from an external GNSS receiver. The GNSS receiver providing NMEA messages should be directly connected to the Aeros or Matrix Pro GS system.

The GNSS receiver configuration requirements are as follows:

- Minimum baud rate of 38400 bps; 115200 is recommended
- GGA NMEA messages at 10 Hz
- VTG NMEA messages at 10 Hz
- ZDA NMEA messages at 1 Hz
- Position data resolution must have a minimum of 6 decimal places; 8 places are recommended
- RTK, DGPS, OmniSTAR™, TerraStart-D or other correction mode improving position quality is highly recommended

## Vehicle Connections

The FieldPilot Pro system or UniPilot Pro system requires a direct connection to a vehicle steering controller. Compatible vehicle steering controllers include add-on hydraulic steering valves and mechanical drive units. The FieldPilot Pro system or UniPilot Pro system can also be directly connected to most vehicle manufacturer factory installed steering systems (ex. Steer-By-Wire).

Many vehicle-specific installation kits are available to fit on each individual make and model. Even if there is not a vehicle-specific kit available for a vehicle, a properly trained installer can often use a custom installation kit to connect the FieldPilot Pro system or UniPilot Pro system to the vehicle. Refer to the vehicle specific installation instructions for additional details on how the FieldPilot Pro system or UniPilot Pro system is connected to the vehicle.

## Accessories Connections

For improved performance and enhanced functionality the FieldPilot Pro system or UniPilot Pro system can be connected to additional sensors and accessories. Those accessories include:

- Remote Engage/Disengage Switch – Allows operator to easily engage and disengage the FieldPilot Pro or UniPilot Pro using a remote switch or foot pedal without the need to press the button on the Display's screen.

## GNSS IS REQUIRED

GNSS is used to configure GNSS Type, GNSS Port, and PRN, as well as to view GNSS status information. For detailed setup instructions, refer to the GNSS chapter in the Aeros or Matrix Pro GS user manual.



1. Press SYSTEM SETUP bottom tab .
2. Press CONFIGURATION side tab .
3. Press **GNSS Receiver Configuration**.
4. Select from:
  - ▶ GNSS Type – sets to accept GNSS source transmissions: GPS, GLONASS, SBAS (with or without DGPS Required)
  - ▶ GNSS Port – sets GNSS communication port to either Internal or External
  - ▶ GNSS Status Information – displays current GNSS status information
  - ▶ Program – only TeeJet support technicians should use this feature
  - ▶ PRN – selects the SBAS PRN that will provide GNSS differential correction data. Set to **Automatic** for automatic PRN selection.
5. Press NEXT PAGE arrow  to set up the selected specific GNSS options.
6. Select:
  - ▶ GPS – uncorrected signals from the GPS system  
*NOTE: GPS is always selected.*
  - ▶ GLONASS – adds uncorrected signals from the GLONASS system
  - ▶ SBAS (e.g. EGNOS, GAGAN, MSAS, SDCM, WAAS) – adds differentially corrected signals from the SBAS system
  - ▶ DGPS Required – adds differentially corrected GPS signals (SBAS must also be selected)  
*NOTE: The console will not allow guidance in DGPS Required mode unless the GGA QI value is 2 or above. (SBAS, RTK or TerraStar corrections are required for operation in this mode.)*
7. Exit this screen to begin initializing the GNSS receiver. This takes about a minute, and the console will not respond until complete.

Figure 4: GNSS



## UNLOCK FIELDPILOT PRO / UNIPILOT PRO

To activate the FieldPilot Pro / UniPilot Pro, the feature must be unlocked.

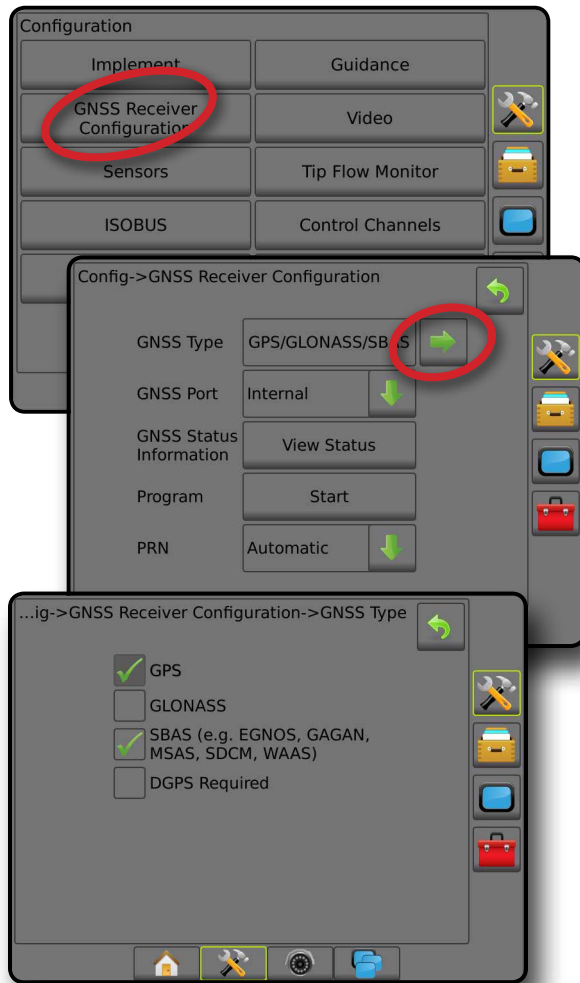

1. Press CONSOLE side tab .
2. Press **Feature Unlock**.
3. Press  **FieldPilot Pro / UniPilot Pro**.
4. Restart the console.

Figure 5: FieldPilot Pro / UniPilot Pro Unlock



If FieldPilot Pro or UniPilot Pro is no longer installed on the system, follow the same steps to lock the feature. This will keep the console from searching for the UniPilot Pro upon startup.

## PUBLIC LIABILITY DISCLAIMER NOTICE

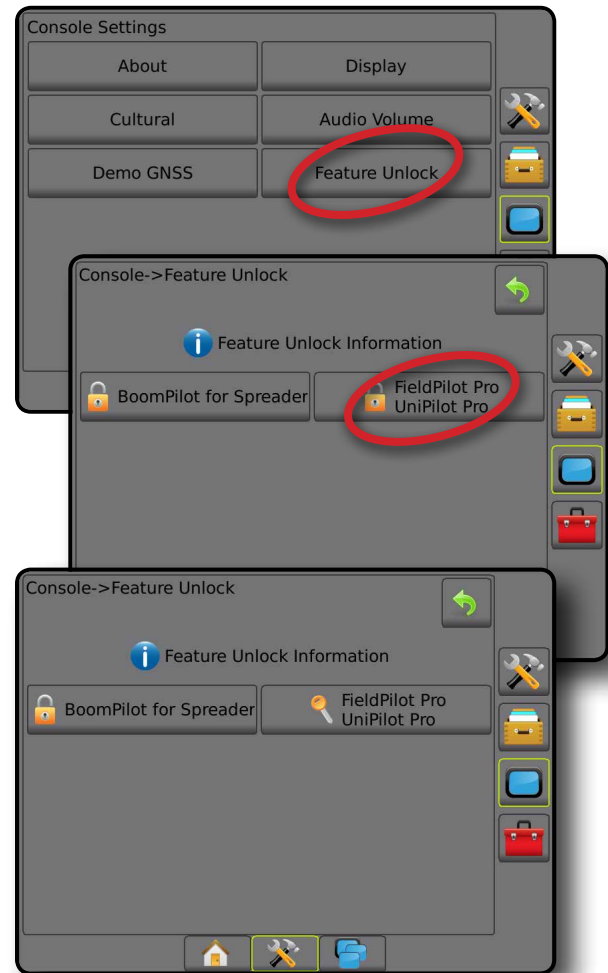
Each time the console restarts, the user will be asked to accept or decline the Public Liability Disclaimer Notice. If the Public Liability Disclaimer Notice is declined, FieldPilot Pro or UniPilot Pro options will not be available. As the operator of this vehicle, YOU ARE RESPONSIBLE FOR ITS SAFE OPERATION!

By pressing the Accept button, you certify that you know how to operate the assisted/automatic steering system, and you accept full responsibility for its safe operation.

*Figure 6: Public Liability Disclaimer Notice*

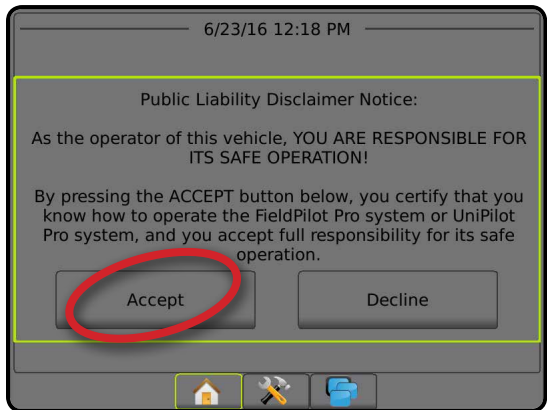

## CHAPTER 2 – SETUP MENU OPERATION

The setup menu allows for creating and managing vehicle profiles, performing system calibrations, adjusting steering behavior, and editing system settings. If changes need to be made to move the system to a different vehicle profile, the operator will need to manage those options in the setup menu.

### Accessing FieldPilot Pro or UniPilot Pro Setup Menu

The FieldPilot Pro system or UniPilot Pro system adds automatic vehicle steering control to compliment the features of the Aeros or Matrix Pro GS.

To access these FieldPilot Pro system or UniPilot Pro system specific setup screens:

1. Press CONFIGURATION side tab .
2. Press **AutoSteer**.
3. Select from:
  - ▶ **Manage Vehicles** – Allows the operator to select, edit, copy, delete, or export/import vehicle profiles as well as
    - Perform a vehicle and sensor calibration for the current vehicle
    - Perform tilt calibration only. This option is available only after the active vehicle has completed the initial calibration.
    - Make adjustments to steering response, line acquisition, heading aggressiveness, reverse response, and motor aggressiveness (for UniPilot Pro).
  - ▶ **Select QI Values** – allows the user to configure the minimum GNSS position quality (precision level) requirements to allow FieldPilot Pro or UniPilot Pro to be activated and remain engaged
  - ▶ **Maximum DOP** – Maximum DOP (Dilution of Precision) sets the maximum value of the overall quality of a GNSS position based on the satellite geometry that is used to calculate it.  
A value of 1 to 2 is excellent, 2-5 is good, 5-10 is moderate, 10-20 is fair, and anything over 20 is poor.  
Assisted/automatic steering should be performed when the DOP is below 4 for best results.
  - ▶ **Transport Mode** – When enabled, all AutoSteer functions are disabled and cannot be activated.
  - ▶ **Service Mode** – When enabled, WiFi will be available through the next power cycle so a technician can connect to the SCM Pro directly for service tasks.
  - ▶ **Operator Presence** – Set Operator Presence Switch response
    - Enable - FieldPilot Pro or UniPilot Pro not possible with switch OPEN. Recommended setting regardless of presence/absence of Operator Presence switch.
    - Disable - Operator Presence detection has been deactivated and will not affect FieldPilot Pro or UniPilot Pro. This is a critical safety feature that should only be disabled when instructed by the machine manufacturer or TeeJet Technologies.

Figure 7: FieldPilot Pro or UniPilot Pro Setup Opening Screen



## SELECT QI VALUES

Select QI (Quality Indicator) Values allows the user to configure the minimum GNSS position quality (precision level) requirements to allow FieldPilot Pro or UniPilot Pro to be activated and remain engaged. The NMEA Standard defines the QI values (see Table 2 below). Some GNSS receiver manufactures do not follow those guidelines so this setting allows the QI value to match that of the receiver manufacturer.

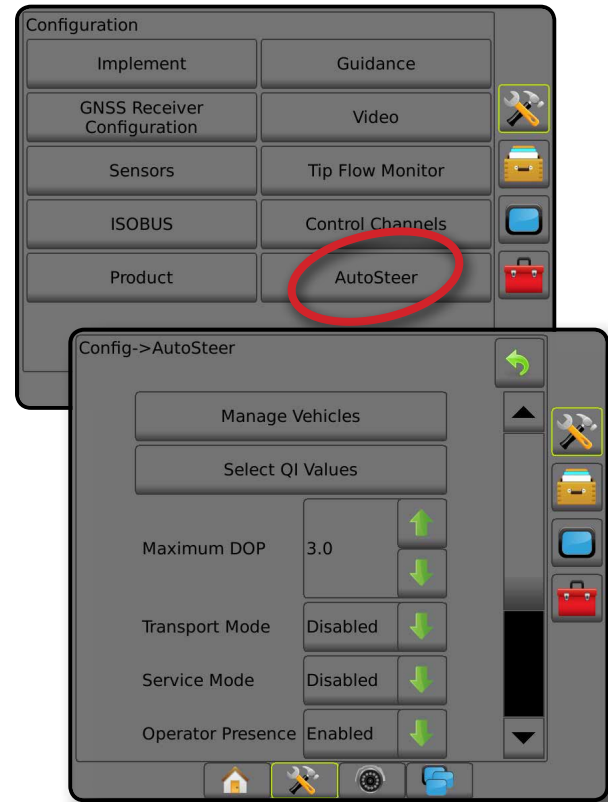
1. Select **Select QI Values** on the FieldPilot Pro / UniPilot Pro screen.
2. Select the NMEA QI values acceptable for use by FieldPilot Pro or UniPilot Pro.
3. Press RETURN arrow ↩ to return to the FieldPilot Pro / UniPilot Pro screen or CONFIGURATION side tab 🛠 to return to the main Configuration screen.

Table 2: QI Values

QI Value	NMEA Standard	Known Other Uses
1	GNSS Fix (SPS)	Autonomous, Novatel GL1DE
2	DGPS (Differential) Fix (SBAS WAAS/EGNOS)	Novatel TerraStar Converging
4	RTK Fix	Hemisphere OmniSTAR converged
5	Float RTK Fix	Hemisphere OmniSTAR converging, or Novatel TerraStar Converged
9	Not defined	Novatel SBAS (e.g. WAAS/EGNOS)

Figure 8: Select QI Values

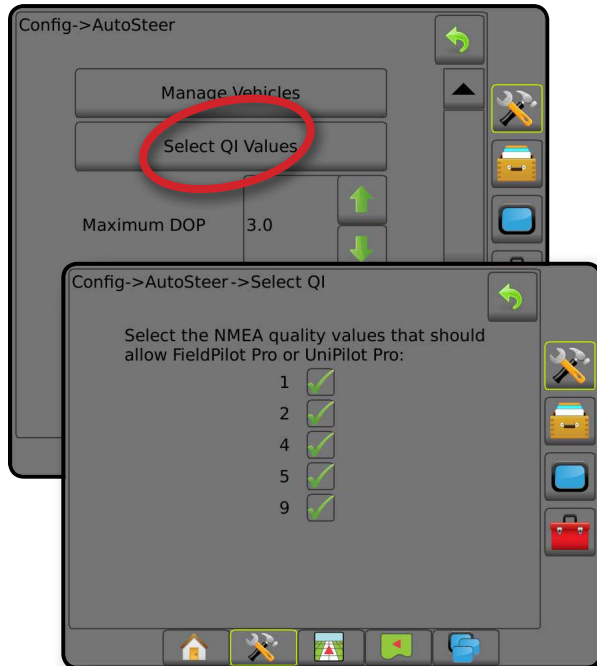

## MANAGE VEHICLES

The Manage Vehicles screen allows the operator to manage the vehicle profiles that have been created on the FieldPilot Pro system or UniPilot Pro system. The FieldPilot Pro system or UniPilot Pro system is designed to be able to be moved from one vehicle to another easily. Each vehicle that it is installed on must have a new vehicle profile that saves the settings, calibration, and tuning values specific to that vehicle. When the system is installed on a different vehicle, the operator must use the Manage Vehicle screens to activate the proper vehicle profile.

*NOTE: The Manage Vehicles screen configures the vehicle settings used only by the FieldPilot Pro system or UniPilot Pro system. The Aeros or Matrix Pro GS also has additional implement management screens that may need to be modified when changing to new vehicles.*

1. Select **Manage Vehicles** on the FieldPilot Pro / UniPilot Pro screen.

2. Select from:

*NOTE: When creating a new vehicle profile or editing an existing vehicle profile, Manual Disengage should be set up before doing the Automatic Calibration.*

- ▶ **New 1** – creates a new vehicle profile.
  - ▶ **Load** – activates the highlighted vehicle profile.
  - ▶ **Edit 1** – allows the operator to modify the parameters of the active vehicle profile including Wheel Base, Antenna In-line Offset Direction & Distance, Antenna Lateral Offset Direction & Distance, Antenna Height, SCM Pro In-line Offset Direction & Distance, SCM Pro Lateral Offset Direction & Distance, SCM Pro Height, and SCM Pro Orientation
  - ▶ **Copy** – duplicates the active vehicle profile
  - ▶ **Automatic Calibration 3** – guides the operator through the calibration process for the active vehicle. The calibration steps teach the FieldPilot Pro system or UniPilot Pro system the characteristics of the vehicle and the steps are critical to achieve optimal control performance.
  - ▶ **Adjust** – after the vehicle has been calibrated, it should perform adequately for most normal field operations. However in some situations, it may be necessary to adjust the steering performance to take into account field conditions, implement selection, traveling speed, etc. The Vehicle Adjust screen enables the operator to adjust the vehicle steering performance to match these changing conditions.
    - **Manual Disengage 2** – adjust the limit at which FieldPilot Pro or UniPilot Pro is disengaged when the steering wheel is being turned manually.
  - ▶ **Delete** – allows the operator to delete a vehicle profile that is no longer needed. The active vehicle profile cannot be deleted.
3. Press RETURN arrow ↵ to return to the FieldPilot Pro / UniPilot Pro screen.

Figure 9: Manage Vehicles

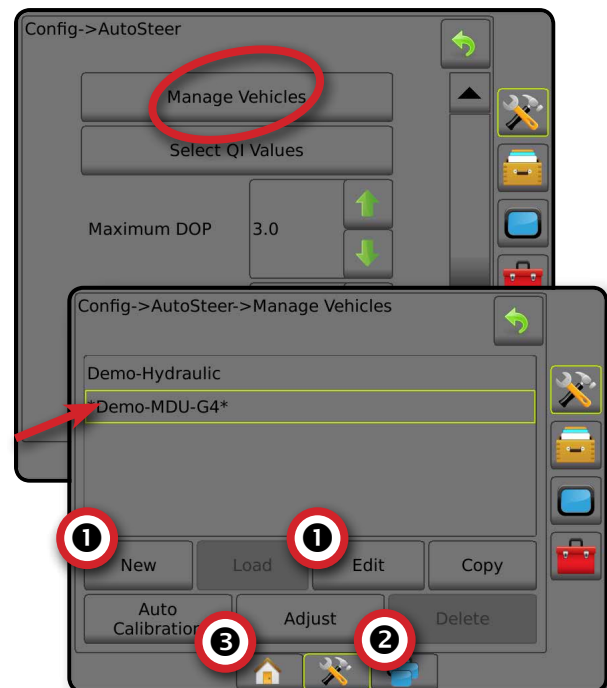

### Active Vehicle

Active Vehicle is highlighted with a set of asterisks (\*). This is the vehicle profile the FieldPilot Pro system or UniPilot Pro system is currently programmed to use.

## New Vehicle Profile

The New option is a step-by-step guide that leads the operator thru the procedure required to create a new vehicle profile. The options will change depending on what type of vehicle is selected and/or what options are installed on the FieldPilot Pro system or UniPilot Pro system.

**NOTE:** Before starting a new profile, the operator should set the proper units of measure in the Display options so the system units will match the measurements. It is also recommended to obtain vehicle measurements prior to beginning (copy and use the worksheet from the Appendix). To complete the calibration process, drive the vehicle to a flat, empty field with no obstructions approximately 300 x 700 ft / ~90 x 200 m in area.

1. Select **Manage Vehicles** on the FieldPilot Pro / UniPilot Pro screen.
2. Press **New**.
3. Setup each option in the following order:
  - ❶ Vehicle Name
  - ❷ Vehicle Type
  - ❸ Vehicle Make
  - ❹ Vehicle Model
  - ❺ Controller Type
  - ❻ Review specific settings:
    - ▶ Wheel Base
    - ▶ Antenna In-line Offset Direction
    - ▶ Antenna In-line Offset Distance
    - ▶ Antenna Lateral Offset Direction
    - ▶ Antenna Lateral Offset Distance
    - ▶ Antenna Height
    - ▶ SCM Pro In-line Offset Direction
    - ▶ SCM Pro In-line Offset Distance
    - ▶ SCM Pro Lateral Offset Direction
    - ▶ SCM Pro Lateral Offset Distance
    - ▶ SCM Pro Height
  - ❼ Wheel Angle Sensor (WAS)
  - ❽ SCM Pro Orientation
4. Press **Commit Vehicle** to save the vehicle profile and load it as the active profile.

See "Vehicle Profile Options" for details on each setting.

Press RETURN arrow ↩ to return to the FieldPilot Pro / UniPilot Pro screen or CONFIGURATION side tab 🛠 to return to the main Configuration screen without committing the new profile.

Figure 10: New Vehicle Profile

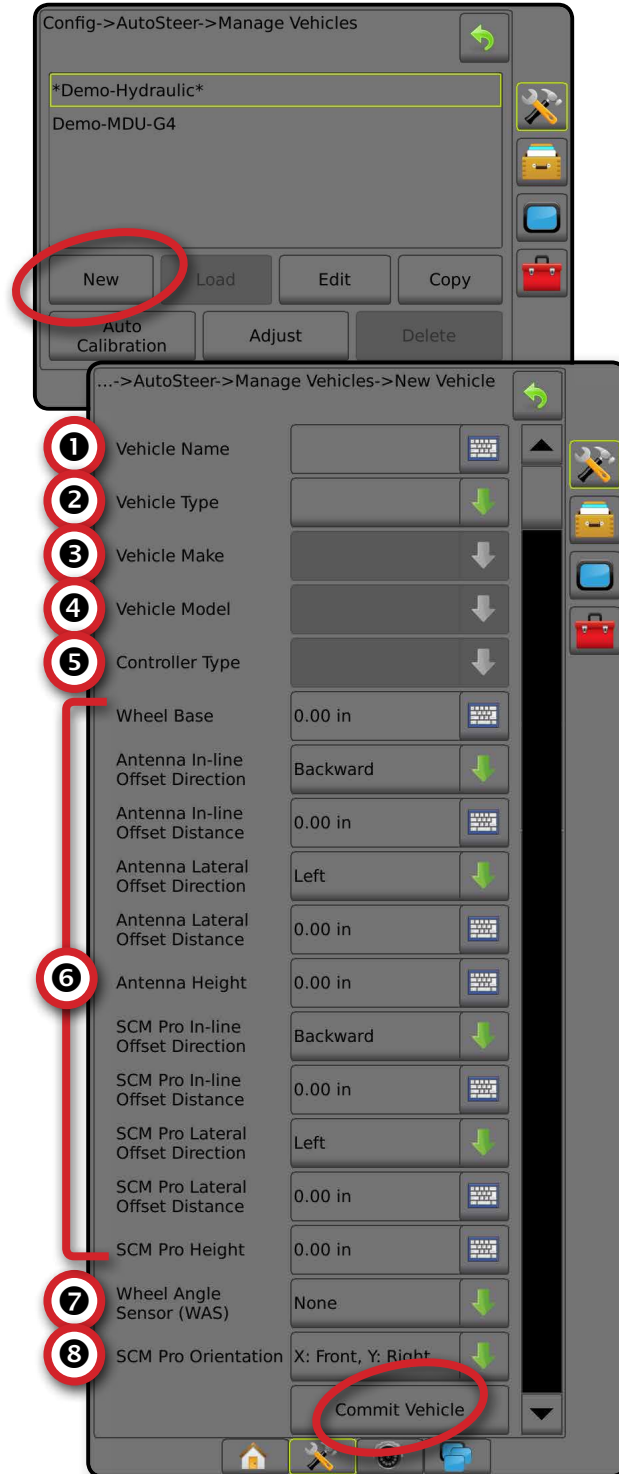



## Edit Vehicle Profile

Edit allows the operator to modify select parameters in the active vehicle profile.

1. Select **Manage Vehicles** on the FieldPilot Pro / UniPilot Pro screen.
2. Press **Edit**.
3. Select from:
  - ▶ Wheel Base
  - ▶ Antenna In-line Offset Direction
  - ▶ Antenna In-line Offset Distance
  - ▶ Antenna Lateral Offset Direction
  - ▶ Antenna Lateral Offset Distance
  - ▶ Antenna Height
  - ▶ SCM Pro In-line Offset Direction
  - ▶ SCM Pro In-line Offset Distance
  - ▶ SCM Pro Lateral Offset Direction
  - ▶ SCM Pro Lateral Offset Distance
  - ▶ SCM Pro Height
  - ▶ SCM Pro Orientation
4. Press **Commit Vehicle** to save the vehicle profile and load it as the active profile.

See "Vehicle Profile Options" for details on each setting.



Press RETURN arrow  to return to the FieldPilot Pro / UniPilot Pro screen or CONFIGURATION side tab  to return to the main Configuration screen without committing the changes.

Figure 11: Edit Vehicle Profile



## Vehicle Profile Options

### Vehicle Name

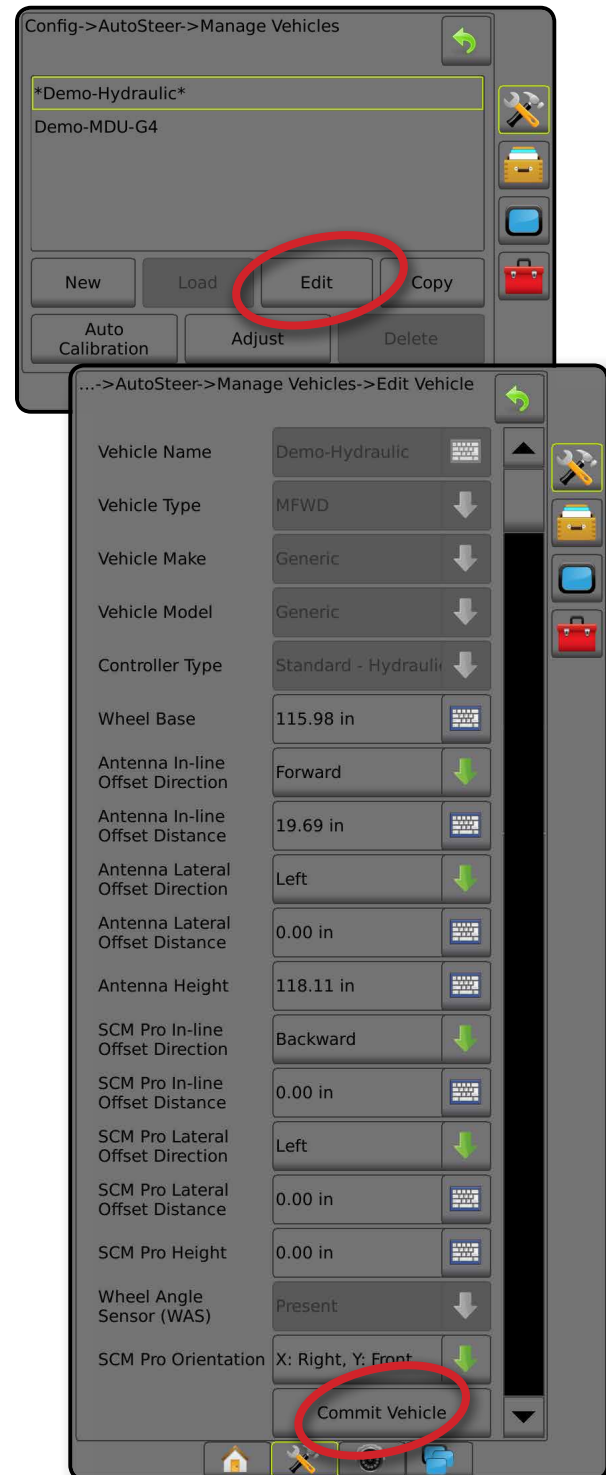
Allows the operator to enter a custom name for the vehicle.



- Maximum length of the name is 20 characters.
- Same name cannot be used twice in the assisted/automatic steering system.
- Name cannot be left blank.
- Name cannot start with a number or other special character. It must always start with a letter.

*NOTE: Vehicle Name is only available when establishing a new vehicle profile.*

### Vehicle Type

Select the type of vehicle that most closely represents your vehicle.

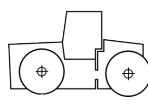
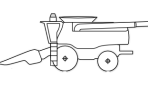
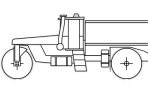
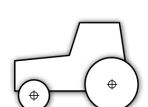
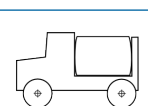
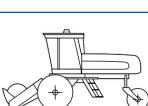
*NOTE: Vehicle Type is only available when establishing a new vehicle profile.*

	Articulated – Large four wheel drive vehicles that steer by articulating in the center of the vehicle are in this group. This group includes tracked articulated vehicles.
	Combine – Grain harvesting and forage harvesting machines where the rear axle is used to steer the vehicle are in this group.
	Floater – Three and four wheeled vehicles with large floatation tires used to spread fertilizer or chemicals on broad acres at high speeds are in this group.
	MFWD – Standard tractors with the steering axle on the front of the machine are in this group. Even if the vehicle does not have MFWD, this should be used.
	Sprayer – High clearance self-propelled sprayers with spray booms are in this group.
	Swather – Swathers and self-propelled mowers are in this group.
	Track – Vehicles that have tracks are in this group. This does NOT include the tracked articulated vehicles.

### Vehicle Make

After selecting the vehicle type, select the make of vehicle which represents your vehicle.

*NOTE: If the vehicle manufacturer is not listed on this screen, select “Generic” from the list. This allows you to create a vehicle that does not have a factory supported installation kit. The generic vehicle profile cannot be used with all vehicle interfaces types such as CAN/ISO. Contact your FieldPilot Pro or UniPilot Pro dealer for further information.*

*NOTE: Vehicle Make is only available when establishing a new vehicle profile.*

### Vehicle Model

After selecting the vehicle type and make, select the model which represents your vehicle. If the vehicle make was “Generic”, only “Generic” will be available.

*NOTE: If the vehicle model is not listed on this screen, you can select a model that is similar to the one that is being installed on or go back to the Vehicle Make options and select “Generic” from the list. This allows you to create a vehicle and model that does not have a factory supported installation kit. Generic settings do not support CAN/ISO vehicles.*

*NOTE: Vehicle Model is only available when establishing a new vehicle profile.*

### Controller Type

The Controller Type represents the controller the FieldPilot Pro system or UniPilot Pro system will be interfaced with in order to steer the vehicle. The FieldPilot Pro system or UniPilot Pro system can be interfaced with a number of controller options including the standard FieldPilot Pro valves, UniPilot Pro, as well as a number of factory installed steering systems.

- ◀ Standard - Hydraulic – This is the FieldPilot Pro steering valve that was installed on the vehicle with the Vehicle Specific Installation kit or generic install. This valve is not a factory installed option.
- ◀ UniPilot Pro – This is the UniPilot Pro system using an ESD Pro.
- ◀ AccuGuide Ready – This represents a factory installed steering system used by Case.
- ◀ Auto-Guide2 – This is used to communicate to the ISOBUS of vehicles under the AGCO manufacturing umbrella. Vehicle makes in this group include AGCO, Challenger, Fendt, Gleaner, Massey Ferguson, and others using the same ISOBUS communications hardware.
- ◀ AutoTrac Ready – This represents a factory installed steering system used by John Deere if the FieldPilot Pro system is being connected directly to the sensors and valves on the vehicle.
- ◀ Vehicle - CAN – This is used for vehicles that use a standard ISOBUS interface such as for Challenger Track and Articulated

vehicles and Krone to interface directly with the vehicles CAN Bus.

- ◀ IntelliSteer Ready – This represents a factory installed steering system used by New Holland.
- ◀ AutoTrac Ready ISO – This represents a factory installed steering system used by John Deere if the FieldPilot Pro system is being connected directly to the ISOBUS on the vehicle and not being connected to the individual sensors and valve.

**NOTE:** Controller Type is only available when establishing a new vehicle profile.

## Wheel Base

The distance between the front and rear axle. This measurement should be accurate to within 2 in / 5 cm.

**NOTE:** For better accuracy in case the steering mechanism is not completely straight, measure the distance between both axles on both sides of the vehicle and use the average of the two measurements.

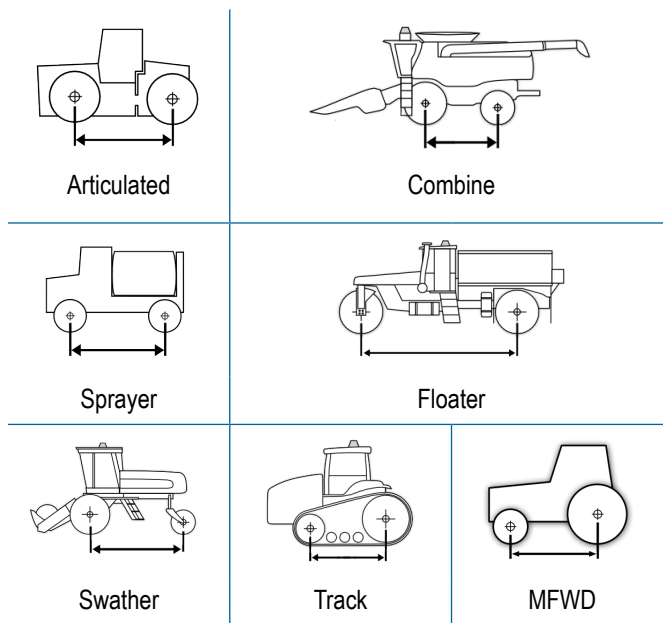

## Antenna In-line Offset Direction & Distance

The GNSS antenna can be mounted in front or behind (while facing in the vehicle's forward direction) the Pivot Point of the vehicle.

The Pivot Point of the vehicle is the place where the vehicle rotates around as it turns left or right. The location of the Pivot Point is different depending on what vehicle type the system is being installed on.

- ◀ Front Axle Steering – The Pivot Point is at the rear axle for MFWD, SPRAYER, and FLOATER vehicle profiles.
- ◀ Track Vehicle – The Pivot Point is at the center point of the track.
- ◀ Articulated Vehicles – The Pivot Point is at the articulation joint of the vehicle.
- ◀ Rear Axle Steering – The Pivot Point is at the front axle for COMBINE and SWATHER vehicle profiles.

The Antenna In-line Offset distance is between the GNSS antenna attached to the vehicle from the Pivot Point location of the vehicle.

First identify the Pivot Point on the vehicle that the FieldPilot Pro system or UniPilot Pro system is being installed on. Take a tape measure and measure the distance between the Pivot Point and the center of the GNSS antenna. This measurement should be accurate to within 1 in / 2.5 cm.

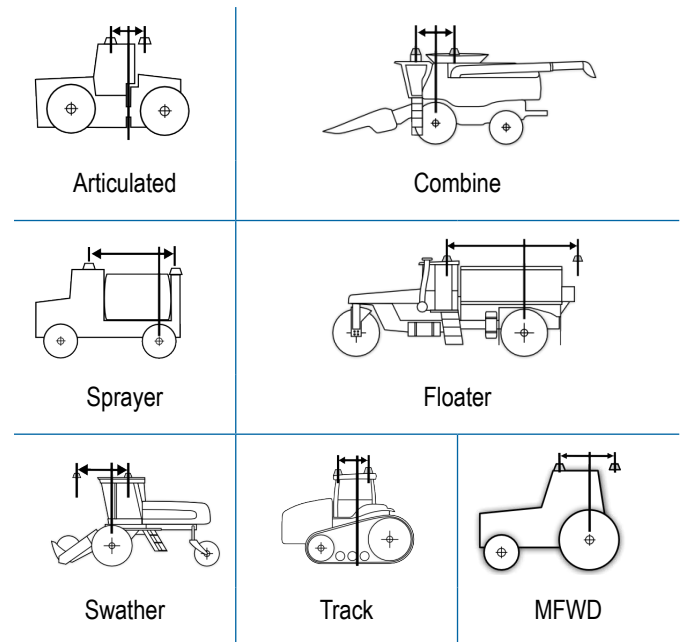

## Antenna Lateral Offset Direction & Distance

For best results, the GNSS antenna should be mounted along the centerline of the vehicle; however it can be mounted to the left or right of the centerline (while facing in the vehicle's forward direction) if necessary.

The Antenna Lateral Offset distance is between the centerline of the implement mounting point on the vehicle to the center of the GNSS antenna.

Under most circumstances, this value should be zero (0) if the GNSS antenna is mounted in the center of the vehicle. If the GNSS antenna is not mounted within 2 in / 5 cm from the centerline, measure this offset and enter this value into this screen. If it is very close to the center just leave the value at zero (0) for now. This value will be adjusted later after the calibration process is complete to ensure that the center of the vehicle is in the same position going both directions on the same A/B Line.

Take a tape measure and measure the distance between the center of the vehicle (typically the drawbar) and the GNSS antenna. This measurement should be accurate to within 1 in / 2.5 cm.

The Antenna Lateral Offset Direction is from the centerline of the implement mounting point on the vehicle to the center of the GNSS antenna while facing in the vehicle's forward direction. Select if the GNSS antenna is mounted to the left or right of the centerline.

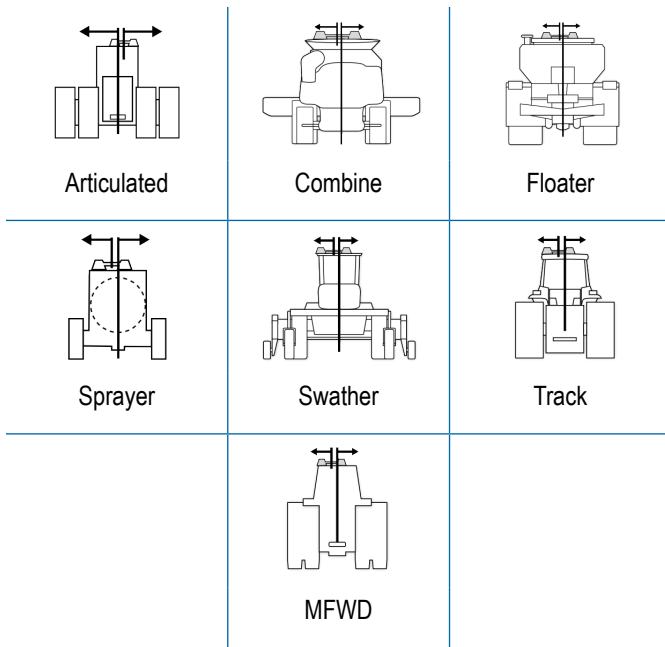

### Antenna Height

Measure the height of the antenna from the ground. This measurement should be accurate to within 2 in / 5 cm. Measured to the bottom of the domed part of the of the GNSS antenna.

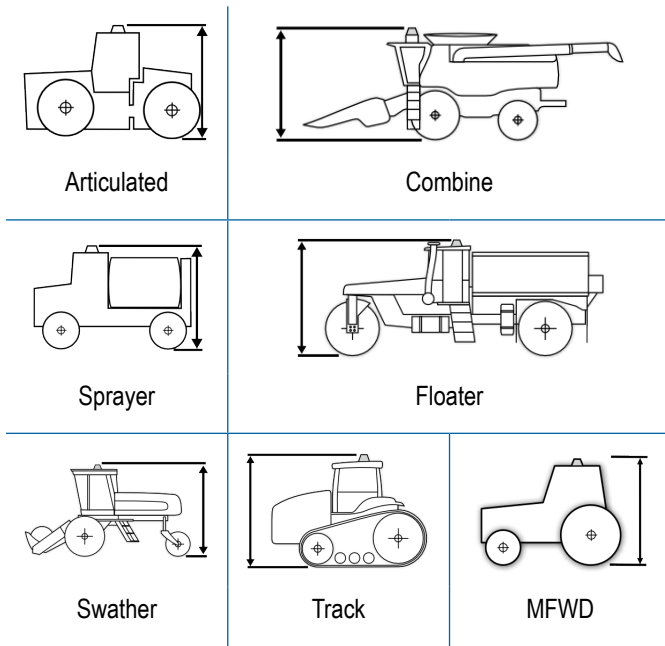
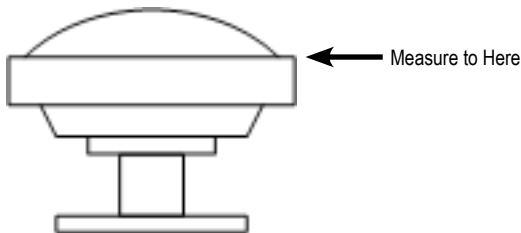

Figure 12: Measuring Point at GNSS Antenna



### SCM Pro In-line Offset Direction & Distance

The direction and distance from the Pivot Point of the vehicle to the center of the SCM Pro while facing in the vehicle's forward direction.

The Pivot Point of the vehicle is the place where the vehicle rotates around as it turns left or right. The location of the Pivot Point is different depending on what vehicle type the system is being installed on.

- ◀ Front Axle Steering – The Pivot Point is at the rear axle for MFWD, SPRAYER, and FLOATER vehicle profiles.
- ◀ Track Vehicle – The Pivot Point is at the center point of the track.
- ◀ Articulated Vehicles – The Pivot Point is at the articulation joint of the vehicle.
- ◀ Rear Axle Steering – The Pivot Point is at the front axle for COMBINE and SWATHER vehicle profiles.

Figure 13: Measurement Point on SCM Pro

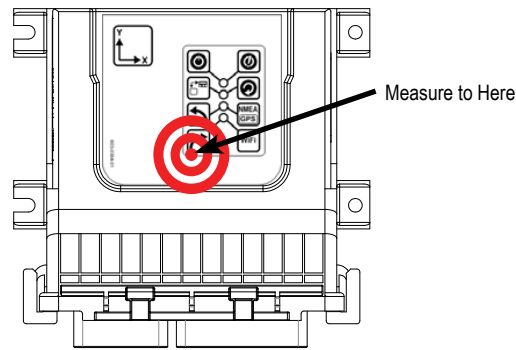

NOTE: The bull's eye is not printed on the actual SCM Pro unit. It is shown here only to indicate the location of the measurement point on the SCM Pro.

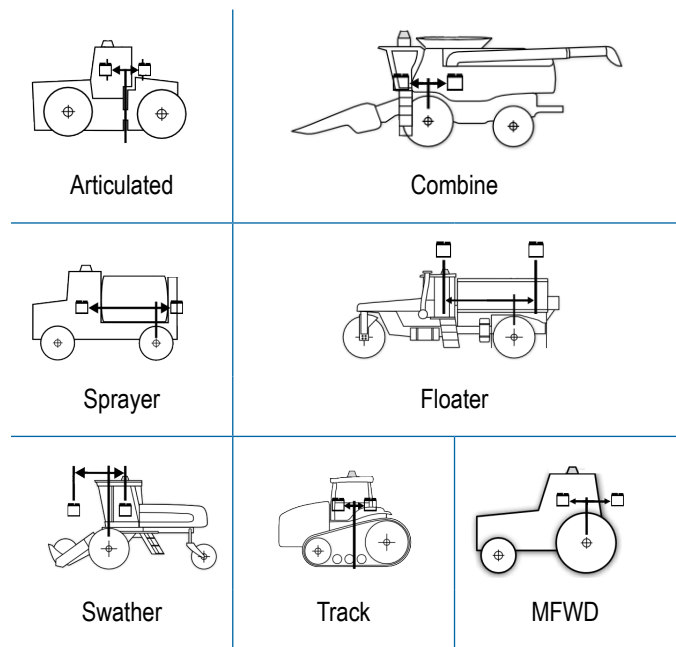

NOTE: Once the system has been calibrated the SCM Pro location measurements should never be changed without completely re-calibrating the system.

SCM Pro In-line Offset distance defines the in-line distance from the Pivot Point of the vehicle to the center of the SCM Pro. This measurement should be accurate to within 1.0 in / 2.5 cm.

### SCM Pro Lateral Offset Direction & Distance

SCM Pro Lateral Offset direction from the Pivot Point of the vehicle to the center of the SCM Pro while facing in the vehicle's forward direction.

SCM Pro Lateral Offset distance from the center of the vehicle (typically the draw bar) to the center point of the SCM Pro. This measurement should be accurate to within 1.0 in / 2.5 cm.

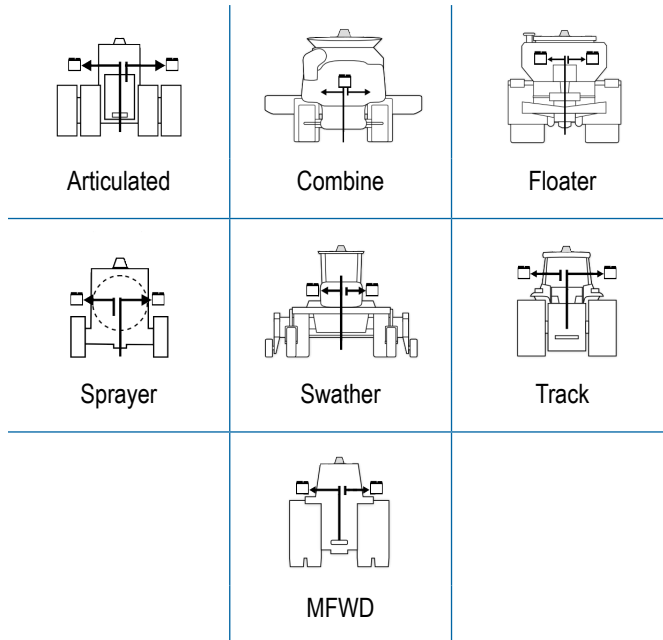

### SCM Pro Height

Measure the height of the center of the SCM Pro from the ground. This measurement should be accurate to within 1 in / 2.5 cm.

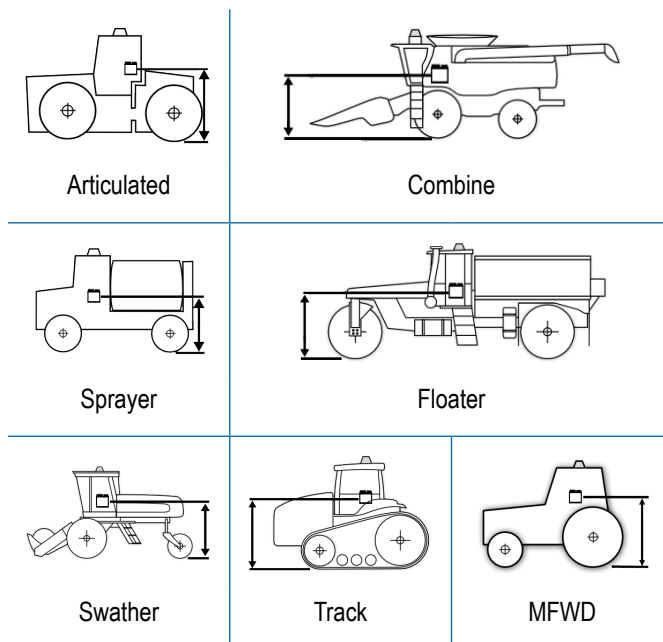

### Wheel Angle Sensor (WAS)

Select if a Wheel Angle Sensor (WAS) is present on the FieldPilot Pro system or UniPilot Pro system.

*NOTE: Only available when establishing a new vehicle profile.*

### SCM Pro Orientation

The SCM Pro needs to know which orientation it is mounted or the system will not work properly. Note the direction of the X and Y on the SCM Pro label in relation to the forward facing direction of the tractor. The view will always be as if the operator is looking down from the top of the cab.

If the SCM Pro has been installed according to the Vehicle Specific Installation Instructions using the designated bracket for that vehicle, the orientation will automatically populate based on the vehicle type, make, and model.

### Orthogonal Orientations

The SCM Pro is mounted orthogonally on the vehicle. This means that the SCM Pro is at a 90 degree angle or some multiple of 90 (0, 90, 180, 270) degrees at all three axes (vertically, horizontally, and perpendicular to the other two) when compared to the direction of travel of the vehicle.

Select one of the 24 possible orthogonal orientations at which the SCM Pro is installed. See "Orthogonal Orientations" table in the Appendix for illustrations of orientations.

### Non-orthogonal Orientations

If the SCM Pro is not on a orthogonal orientation (at a multiple of 90 degrees (0, 90, 180, 270) at all three axes (vertically, horizontally, and perpendicular to the other two) when compared to the direction of travel of the vehicle), choose "Non Orthogonal" and enter the specific X, Y, and Z angles.

- **X Angle/Pitch** - This is the front to back rotation of the SCM Pro as compared to the vehicle. How many degrees it must be rotated from the Base Orientation position [X: Front, Y: Right] to match the actual orientation on the vehicle.
- **Y Angle/Roll** - This is the side to side rotation of the SCM Pro as compared to the vehicle. How many degrees it must be rotated from the Base Orientation position [X: Front, Y: Right] to match the actual orientation on the vehicle.
- **Z Angle/Yaw** - This is the rotation of the SCM Pro compared to the vehicle looking down from the top. How many degrees it must be rotated from the Base Orientation position [X: Front, Y: Right] to match the actual orientation on the vehicle.

**NOTE:** Only properly trained technicians should use this option. The angles need to be precisely measured and calculated to allow the FieldPilot Pro system or UniPilot Pro system to work properly. Entering incorrect values will cause the system to perform poorly. Always attempt to attach the SCM Pro orthogonally if possible. Always contact your FieldPilot Pro or UniPilot Pro Dealer for assistance in entering the correct angles.

Figure 14: Non-orthogonal Options

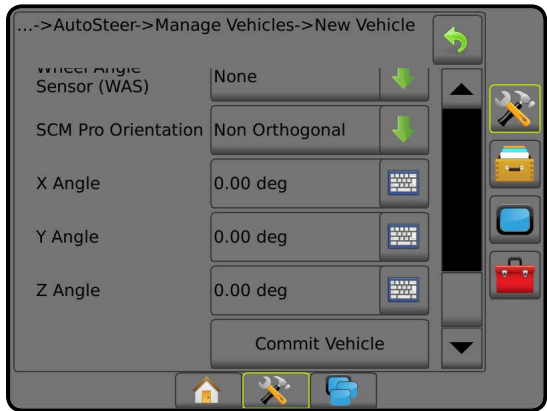

See the Appendix for orientation examples.

Figure 15: Base Orientation Position with (X=0, Y=0, Z=0)

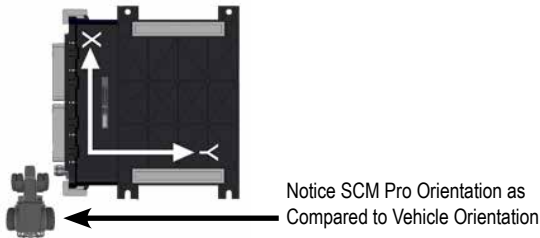





## Manual Disengage

Adjust the limit at which FieldPilot Pro or UniPilot Pro is disengaged when the steering wheel is being turned manually.

If the installation has a pressure transducer installed on the vehicle or the system is connected to the UniPilot Pro, Manual Disengage will be an option. It should be calibrated prior to beginning the Auto Calibrate procedure.

**NOTE:** If the Manual Disengage is not properly adjusted, the system may not disengage properly when the operator turns the steering wheel which may cause the operator not to be able to avoid an obstacle and cause an accident. Never operate the FieldPilot Pro system or UniPilot Pro system without the Manual Disengage functioning and properly set.

**NOTE:** Verify that the vehicle and oil are at normal operating temperatures prior to setting the Manual Disengage.

1. Select **Manage Vehicles** on the FieldPilot Pro / UniPilot Pro screen.
2. Press **Adjust**.
3. Press the Manual Disengage **Adjust** button.
4. Press **Start** to begin simulation.
5. While watching the Pressure Graph, turn the steering wheel and note the maximum value reached.
6. Repeat steps 4 and 5 two more times.
7. Calculate the average of the three values seen on the Pressure Graph.
8. Using the UP/DOWN buttons  , adjust the Saved Value to the new average.
9. Press **Save Limit**.
10. Press RETURN arrow  to return to the FieldPilot Pro / UniPilot Pro screen or CONFIGURATION side tab  to return to the main Configuration screen without committing the changes.

## Pressure Graph

This graph shows a graphical representation of the oil pressure from the pressure transducer. The shaded area will move starting from the left side of the graph in relationship to the actual pressure transducer reading.

### Saved

This is the pressure value that is currently saved for the vehicle profile that it uses to disengage FieldPilot Pro or UniPilot Pro. This value is also shown graphically on the Pressure Graph by the red diamond on the graph. This value will not change until the Save Limit button is pressed.

### Current

This is the real time pressure reading measured by the pressure transducer.

## Start

Press this button to put the system into a FieldPilot Pro or UniPilot Pro simulation. The Start button will change to a Pause button. Test the manual steering override threshold value by turning the steering wheel. If the FieldPilot Pro system or UniPilot Pro system reaches the threshold pressure, the Pause button will change back to the Start button. Use this procedure to test the FieldPilot Pro system or UniPilot Pro system to verify the manual steering override works properly.

## Session Manual Steering Override Threshold

This value is not labeled, however it is the value shown below the Pressure Graph. For all tests performed in the Manual Steering Override screen, this is the actual value that is being adjusted and tested. This value can be adjusted with the Up/Down buttons for testing. This value will not be saved to the vehicle profile until the Save Limit button is pressed.

## Up/Down Buttons

These buttons decrease or increase the pressure value for the Session Manual Steering Override Threshold value while the operator is in the Manual Steering Override screen. Pushing these buttons will move the red diamond left or right on the graph. Use these buttons to fine tune and manually adjust the manual steering override threshold value required to make the FieldPilot Pro or UniPilot Pro disengage.

## Save Limit

This button must be pressed before leaving the Manual Steering Override screen in order to save the Session Manual Steering Override Threshold value. Once this button is pressed, the Saved value will change to match the Session Manual Steering Override Threshold and that value and the Samples value are saved for the current vehicle profile. If this button is not pressed before exiting the Manual Steering Override screen all changes will be lost.

Figure 16: Manual Disengage

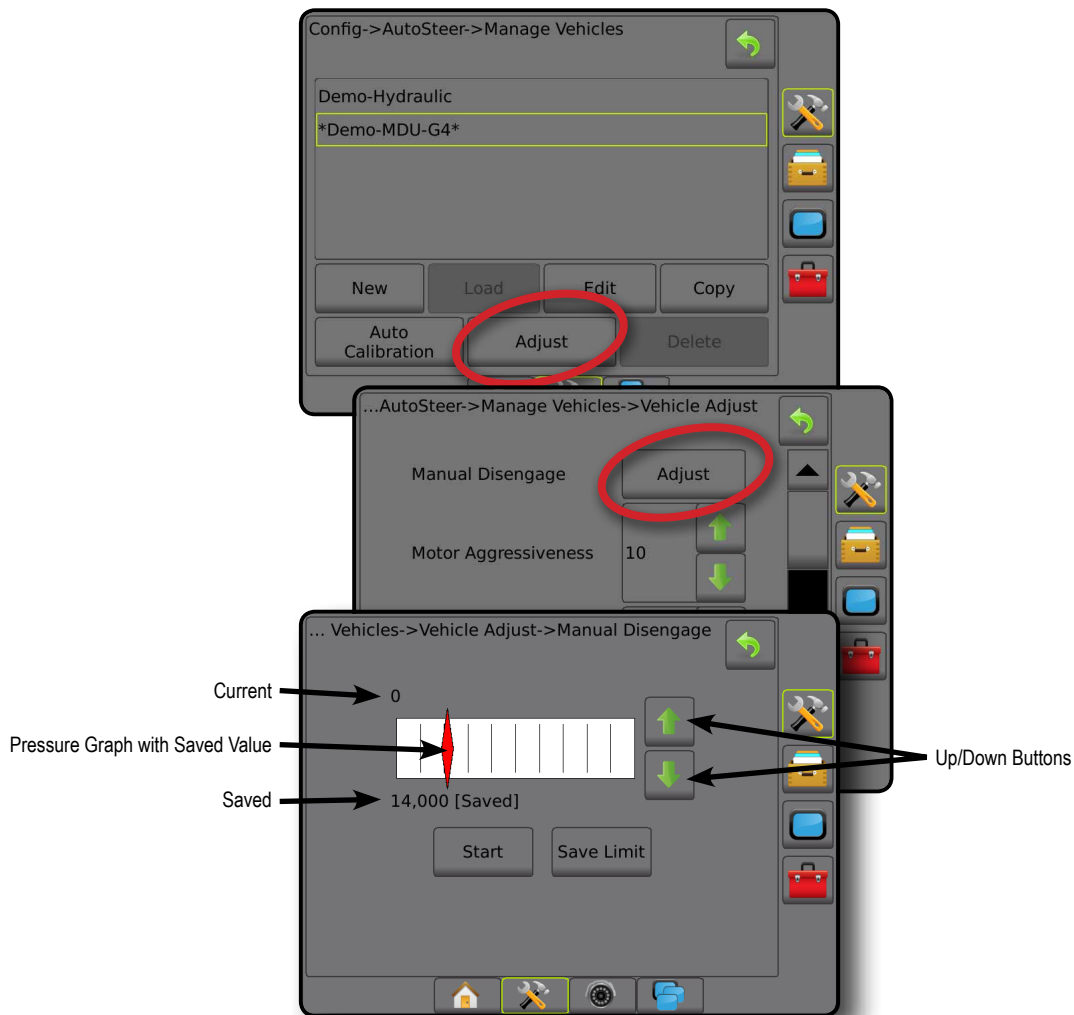

## Automatic Calibration

The Automatic Calibration procedure guides the operator through the calibration process for the active vehicle. The calibration steps teach the FieldPilot Pro system or UniPilot Pro system the characteristics of the vehicle and the steps are critical to achieve optimal control performance.

**NOTES:** Prior to beginning the calibration process, the vehicle and oil in the vehicle must be warmed to normal operating temperatures.

All implements should be removed from the vehicle prior to beginning the calibration process.

During the calibration process, have the vehicle's engine set at normal operating speed or at least at a minimum of 1600 RPM.

The Automatic Calibration takes a significant amount of space for the vehicle to operate within. Depending upon the vehicle size and type it may take at minimum approximately 300 x 700 ft / 90 x 200 m to complete the Automatic Calibration procedure.

The vehicle will automatically execute a series of maneuvers during the calibration process including turning full left and full right. The calibration trajectory depends on vehicle type, controller and other differences in the vehicle. Always be prepared to take steering over manually if the vehicle drives towards an obstacle.

The field used for calibration must be dry (no water, snow or mud) and should be flat.

It is critical to have the best possible GNSS position quality for successful calibration. Before starting calibration please verify that the GNSS uses the maximum number of available satellites and the augmentation system (ex. RTK, DGPS) is up and operating.

For the best results it is recommended to drive vehicle forward for at least 200 ft / 60 m with speed at least 4 mph / 6 km/h to establish good GNSS heading before calibration.

The Automatic Calibration provides specific instructions and speed requirements during each step of the process. The calibration steps and time vary according to the vehicle type and equipment installed. Follow the on screen instructions to perform the Automatic Calibration procedure.

The following figure depicts a calibration trajectory for a specific vehicle as an example. It also shows sections of specific calibration steps. Every vehicle's trajectory will be different.

Figure 17: Calibration Trajectory Example

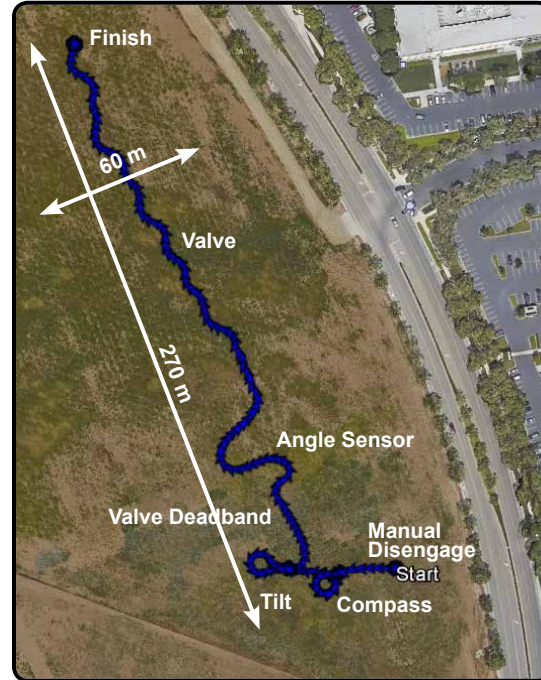

**NOTE:** The calibration trajectory changes depending vehicle type, controller, and other differences in the vehicle.

Procedures and steps will be different depending on the vehicle and hardware installed on the vehicle.

1. Select **Manage Vehicles** on the FieldPilot Pro / UniPilot Pro screen.
2. Press **Auto Calibration**.
3. Follow the on screen instructions. Calibration processes for the following will begin in the following order (as available):
  - ▶ Compass Calibration
  - ▶ Wait for Heading
  - ▶ Tilt Zero Initial Direction
  - ▶ Tilt Zero Opposite Direction
  - ▶ Valve Deadband
  - ▶ Angle Sensor
  - ▶ Valve
  - ▶ UniPilot Pro Deadband
  - ▶ UniPilot Pro
  - ▶ Curvature
4. On the Calibration Complete acknowledgement, press **OK** to return to the FieldPilot Pro / UniPilot Pro screen.

For more details on a specific calibration procedure, see the following sections.



Figure 18: Automatic Calibration

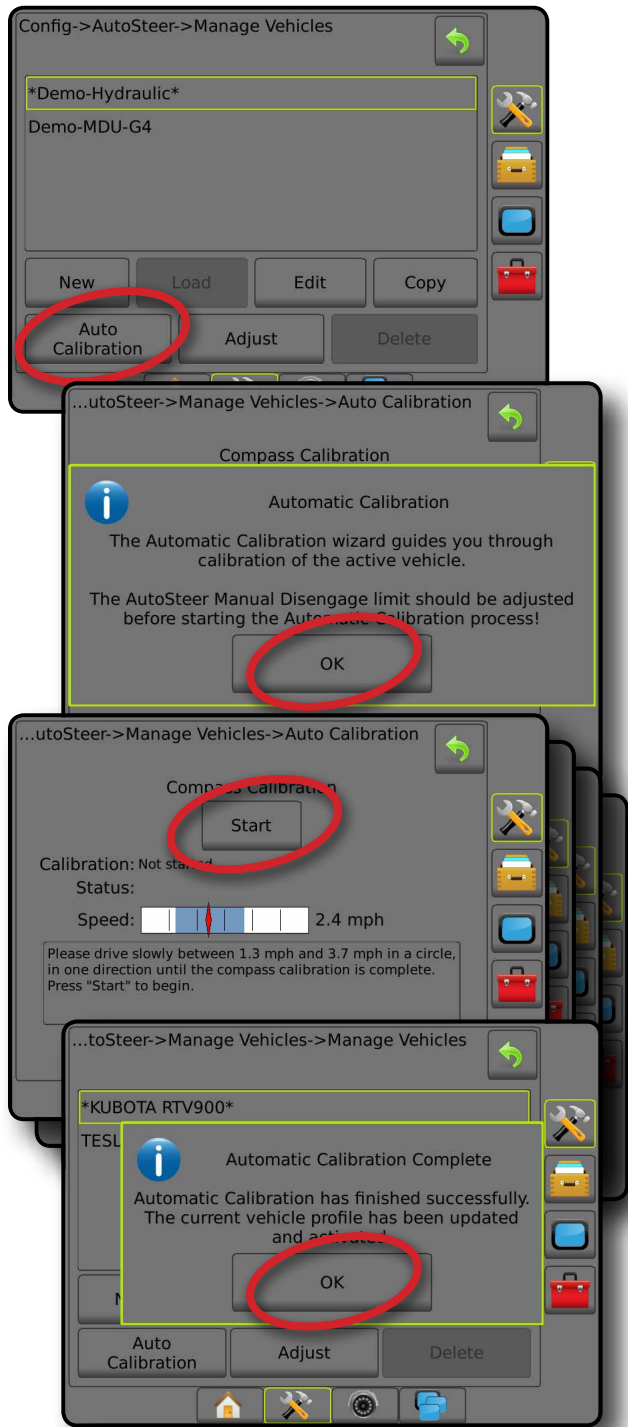

## Compass Calibration

The SCM Pro has a built in compass that allows it to determine the heading the vehicle is facing. The compass needs to be calibrated against the heading calculated by the GNSS system. For this step the operator must drive the vehicle in a slow concentric circle to allow the FieldPilot Pro system or UniPilot Pro system to compare the compass readings with the GNSS heading.

*NOTE: In order to increase the integrity of the Compass Calibration, the driver must hold the steering wheel at a constant angle and keep the vehicle at a constant speed. Do not start the calibration process until the vehicle is in this constant arc motion. It is suggested to drive an entire circle prior to starting the compass calibration to ensure there is enough space available and to aid the operator by providing vehicle tracks to follow.*

Follow the procedure below to complete the calibration.

1. Start driving the vehicle within the speed range 1.3 to 3.7 mph / 2.0 to 6.0 km/h.
2. Turn the steering wheel in either direction and hold it at a constant angle so the vehicle will make a constant radius circle. Steer the vehicle so it makes a circle around 30 to 50 ft / 9 to 15 m in diameter.
3. When the vehicle is moving at the correct speed and in a circle, press **Start** to start the calibration.

*NOTE: Pressing the Pause button then pressing the Resume button will restart the Compass Calibration from the beginning.*

Figure 19: Compass Calibration

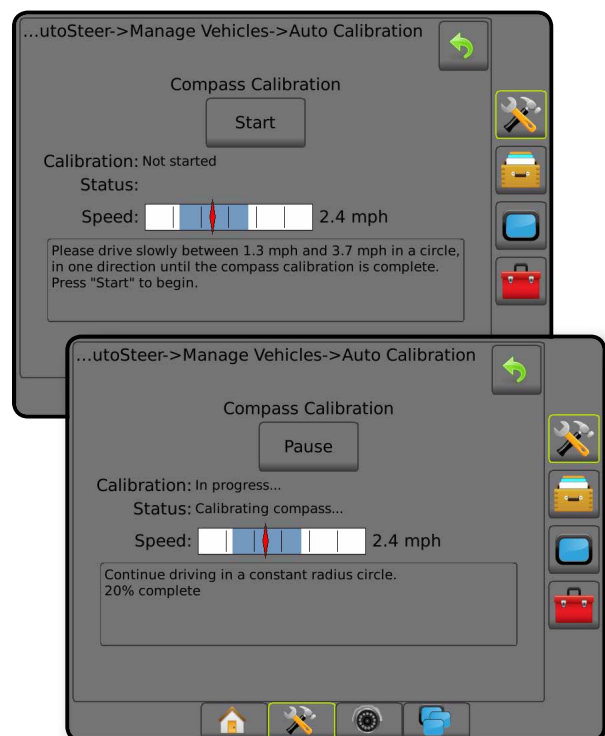

- During the Compass Calibration process the system will display a progress indicator in percentage. Continue driving in a circle until the compass calibrates and the next calibration screen appears.

## Compass Calibration Errors

If the Compass Calibration process did not complete successfully one of the errors shown in Table 3 may be shown. If any of the errors occur, the operator should correct the situation and press the Resume button to perform the Compass Calibration process again.

Table 3: Compass Calibration Errors and Remedies

Error Message	Possible Cause	Remedy
Speed out of range	Vehicle speed has gone outside the allowable speed range	Drive at constant speed in range between the values shown on the display. Avoid speeds close to the range limits.
Circle is not round enough	Vehicle was driven over an ellipsoid or rectangle	Drive in a round circle between 30 to 50 ft / 9 to 15 m in diameter
Data distribution is not even	Vehicle was not driven at a constant speed	Drive circles at a constant speed. Set the speed before pressing the Start button.
Compass data too noisy	Vehicle electromagnetic equipment like AC fan near SCM Pro was turned on or off, metal tools were moved around SCM Pro, or SCM Pro is not mounted firmly	Drive on a flat area and do not change state or position of any devices or tools that can change an electromagnetic field near SCM Pro. Verify the SCM Pro is mounted firmly on the bracket

When the Compass Calibration has completed successfully, the system will automatically proceed to the next step.

## Wait for Heading

Step to verify that the compass and GNSS heading calculation match

*NOTE: This step will require the operator to drive in a straight line.*

*Before this step the operator may turn the vehicle to any direction where such driving is safely permitted.*

Follow the procedure below to complete the calibration.

- Start driving in a straight line within the speed range 1.3 to 3.7 mph / 2.0 to 6.0 km/h.
- When the vehicle has reached the minimum speed, the verification process will begin and the status will show the system is warming up. Continue driving in a straight line within the speed range requested by the display.
- If the calibration was successful and there are no problems, the status should quickly (within 10 seconds) show the heading is ready. At this point, press **Next** to continue with the calibration.

Figure 20: Wait for Heading

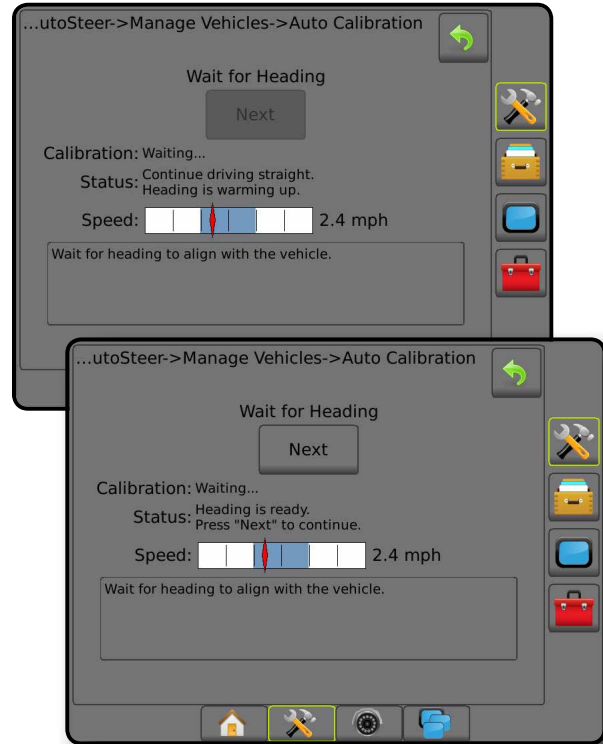

*NOTE: If the orientation has been set incorrectly, the FieldPilot Pro system or UniPilot Pro system will not be able to accurately determine a heading. Drive the vehicle forward for 500 ft / 150 m and then restart the calibration.*

*NOTE: The vehicle must be moving with the required speed range for the Next button to be active.*

## Tilt Zero Calibration

The FieldPilot Pro system or UniPilot Pro system uses its sensors to determine the tilt of the vehicle as it travels through the field. This is important to allow the system to calculate the true position of the wheels if the cab is tilting to one side or another. The GNSS antenna is generally mounted on top of the cab so even though the GNSS antenna may move as the cab moves due to the terrain change, the center-line of the vehicle will still be on the straight line. If the tilt of the vehicle is not accurately measured, the system will not be able to control the vehicle accurately.

The Tilt Calibration is a two step process. The vehicle must be parked on a flat area and left to sit. The system then takes the sensor readings for a short time to get a base line. The vehicle must then be driven, turned around to face the opposite direction, and stopped at the exact same place. The system then takes the sensor reading while faced in the opposite direction. The system is then able to use the two sets of readings to zero out the slight tilt errors of the sensors. The sensors read both the fore and aft (pitch) as well as side to side (roll) tilt errors.

**NOTE:** It is important that the Tilt Calibration takes place on a flat area with no slope. If this step is performed on a slope, the FieldPilot Pro system or UniPilot Pro system may not be able to accurately control the vehicle.

## Initial Direction

This is the first stage of the Tilt Calibration procedure.

Follow the procedure below to complete the calibration.

1. Drive the vehicle onto a flat surface, stop and apply brake.
2. When vehicle is stationary and stabilized, press **Resume**.
3. The display will show a countdown, when this step is complete, the calibration process will automatically move on to the next step.
4. Mark the front and rear wheels or the center of the track of the vehicle with flags.

Figure 21: Tilt Zero Initial Direction Calibration

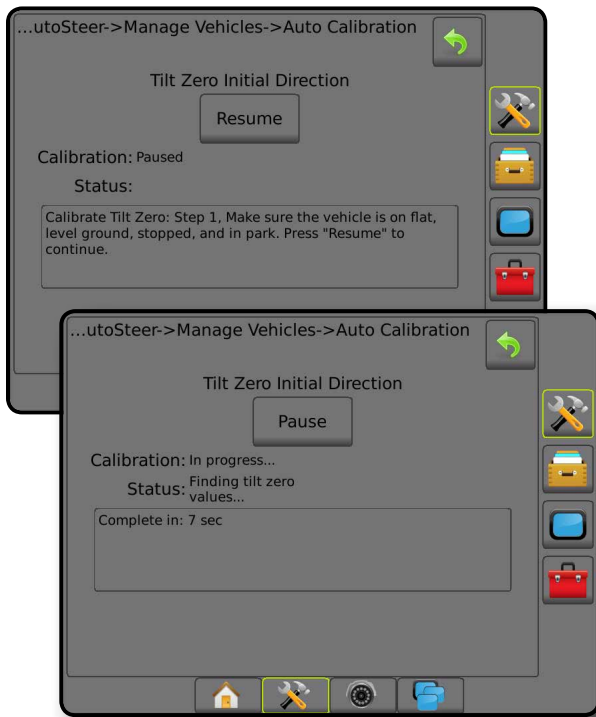

## Opposite Direction

This is the second stage of the Tilt Calibration procedure.

**NOTE:** It is important that the vehicle is positioned in the exact same place as the previous step but facing in the opposite direction. If the vehicle is not placed in the same position, the tilt compensation will be incorrectly calculated and vehicle steering performance will be degraded.

Follow the procedure below to complete the calibration.

1. Drive the vehicle forward and then turn it around as shown.

Figure 22: Driving Around for Tilt Calibration

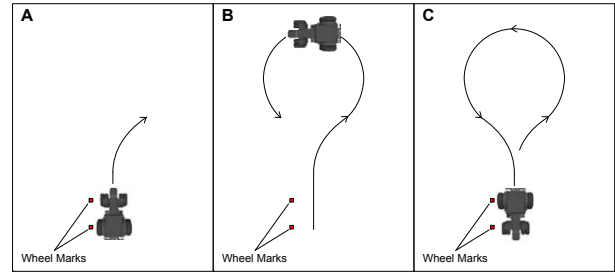

2. Stop the vehicle in the exact same location shown by the previously set marks so that the rear tires are now over the marks of the front tires or the center of the track is at the same point but in the opposite direction.
3. When vehicle is stationary and stabilized, press **Resume**.
4. The system will show a countdown. Wait for system to finish measuring and if the Tilt Calibration is successful the system will proceed automatically to the next step.

Figure 23: Tilt Zero Opposite Direction

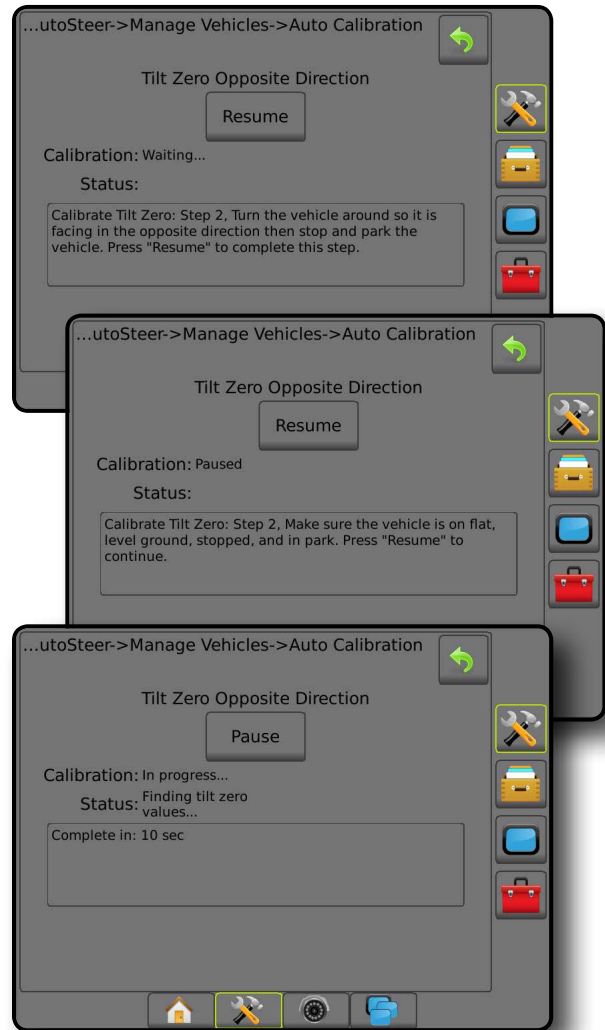

## Tilt Calibration Errors

If the Tilt Calibration did not complete successfully a pop-up window with the error information will be shown.

Possible causes of Tilt Calibration errors and their remedies are listed in Table 4. If this error message is displayed, the operator should correct the situation and then repeat the Tilt Calibration. Press the Abort button to cancel the entire calibration process and restart the calibration from the beginning.

Table 4: Tilt Calibration Errors and Remedies

Error Message	Possible Cause	Remedy
Calibration Error	Incorrect SCM Pro installation	Check and correct SCM Pro physical installation. Use roll and pitch angles and notes (ex. 'front is too low') from the error message to understand a possible misalignment.
	Incorrect SCM Pro orientation is entered in the vehicle profile	Check and correct orientation settings in the vehicle profile.
Calibration Error: Tilt exceeded XX degrees Roll XX degrees Pitch XX degrees	Initial and Opposite Direction Calibration steps were done on uneven surface	Repeat the calibration on a flat surface. Verify the vehicle is stationary and stabilized before pressing Resume button.

## Valve Deadband

Vehicle types that have a steering valve that are controlled directly by the FieldPilot Pro system or UniPilot Pro system use this calibration procedure. This includes vehicles that use the standard add-on FieldPilot Pro Valves, AutoTrac Ready (non ISO), AccuGuide Ready, IntelliSteer, and some others.

*NOTE: Verify that the engine RPM is at the working speed while this part of the calibration is taking place.*

Oil flow allowed through the steering valve is proportional to the electrical signal sent from the FieldPilot Pro system or UniPilot Pro system. It takes a certain minimum amount of signal from the FieldPilot Pro system or UniPilot Pro system before the valve ports are opened. If the signal is below that minimum amount, no oil flows through the steering valve and the steering mechanism will not move. The range of signals where there is no steering valve movement is called the deadband. The FieldPilot Pro system or UniPilot Pro system detects the deadband is detected by incrementally increasing the signal sent to the steering valve in both directions until the FieldPilot Pro system or UniPilot Pro system detects motion from the wheel angle sensor. It is important for the system to accurately detect at what point the steering valve starts moving to provide small, accurate control commands during FieldPilot Pro or UniPilot Pro operations.

Figure 24: Valve Deadband Calibration in Progress

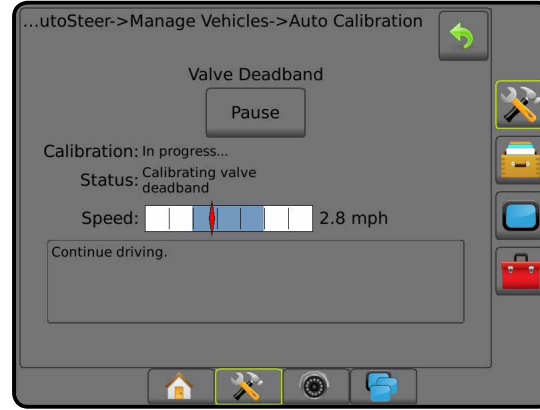

Follow the procedure below to complete the calibration.

1. Drive the vehicle in a straight line within the speed range 1.3 to 3.7 mph / 2.0 to 6.0 km/h.
2. Press **Resume** button to start the calibration process.
3. The vehicle will drive in a straight line for a time. Eventually the steering axle will begin to move to one direction and then to the other.
4. Once this happens the system will have determined the deadband for the steering valve and move on to the next step.

## Angle Sensor

If a Wheel Angle Sensor is installed on the vehicle and the FieldPilot Pro system or UniPilot Pro system receives input directly from it, the FieldPilot Pro system or UniPilot Pro system reads the value of this sensor to determine the position of the steering mechanism. This includes vehicles that use the standard add-on wheel angle sensor, AutoTrac Ready (non ISO), AccuGuide Ready, IntelliSteer, and some others. This procedure is also used by UniPilot Pro installations using a wheel angle sensor.

During the calibration process, the FieldPilot Pro system or UniPilot Pro system first commands the steering mechanism to turn full left and right to detect the maximum sensor values.

*NOTE: It is important that the Wheel Angle Sensor is able to sense changes throughout the entire motion of the steering mechanism. If the wheel angle sensor goes below the minimum (0) or above the (65535) count values prior to reaching the stops, the calibration will fail.*

After the maximum limits are determined, the FieldPilot Pro system or UniPilot Pro system will command the steering valve or UniPilot Pro to hold the steering mechanism at a constant angle at different positions starting from full left and moving to full right. At each of these stops, the system measures the actual change of heading using the change in GNSS positions. After the calibration process has completed the full left to right test, it then estimates where the steering mechanism should be at to steer straight ahead. The system then records a few

more samples from both sides of that point to ensure it knows when the vehicle is traveling straight ahead.

At the conclusion of the calibration the FieldPilot Pro system or UniPilot Pro system can determine the expected change of heading for any wheel angle sensor position. It is also able to determine the exact sensor reading that should steer the vehicle in a straight line. The sensor calibration is robust and allows the system to determine the correct sensor readings to use even if the sensor is not installed with equal steering angles to the left and right.

Figure 25: Angle Sensor Calibration in Progress

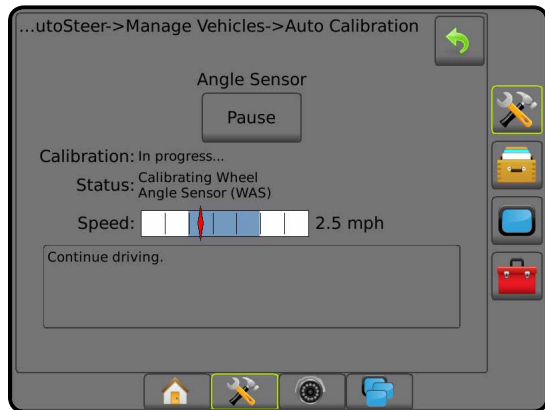

Follow the procedure below to complete the calibration.

**NOTE:** For the next step in the calibration process, the vehicle will turn full left and full right. Make sure all objects are clear of the area where calibration is taking place.

1. This procedure begins automatically after the Valve Deadband step has completed. Continue allowing the vehicle to drive in a straight line within the speed range requested by the display.
 

**NOTE:** If Angle Sensor calibration does not start automatically, press the Resume button to start it.
2. The steering mechanism will make a hard turn to one direction and then back to the opposite direction to find the maximum sensor stops.
3. The system will then reposition the sensor at regularly spaced increments between the two maximum positions and measure the heading change at each position. The system will work from one direction, decreasing the rate of turn gradually, continue past the straight ahead position, and then start making increasingly sharp turns in the opposite direction.
4. It will move back in the opposite direction and record a few more samples from around the straight ahead position.
5. Once this is completed, the calibration process will move on to the next step.

## Valve

Vehicle types that have a steering valve that is controlled directly by the FieldPilot Pro system or UniPilot Pro system use this calibration procedure. This includes vehicles that use the standard add-on FieldPilot Pro valves, AutoTrac Ready (non ISO), AccuGuide Ready, IntelliSteer, and some others.

**NOTE:** Verify that the engine RPM is constant at the working speed while this part of the calibration is taking place.

The Valve calibration measures the rate of turn using the wheel angle sensor at different signal commands sent to the steering valve. As the signal to the steering valve is increased, the rate of turn at the wheel angle sensor should also increase. The FieldPilot Pro system or UniPilot Pro system takes readings of the wheel angle sensor rate of turn at different signal commands so the system knows how fast the vehicle will turn at any signal command sent to the steering valve.

Figure 26: Valve Calibration in Progress



Follow the procedure below to complete the calibration.

1. This procedure normally begins automatically after the Angle Sensor step has completed. Continue allowing the vehicle to drive in a straight line within the speed range requested by the display.
 

**NOTE:** If the Valve calibration does not start automatically, press the Resume button to start it.
2. The FieldPilot Pro system or UniPilot Pro system will command the vehicle to turn the steering mechanism to one direction using the maximum signal and then to the opposite direction at the maximum signal. It will repeat this two more times.
3. Next it will start turning the steering mechanism in both directions and measure the speed at which it turns. It will test various command rates (slow, medium, and fast turns) to both the left and right. At the conclusion of this calibration step, the FieldPilot Pro system or UniPilot Pro system will be able to know how fast it will turn the steering mechanism at any signal strength it sends to the steering valve.
4. The system will then move on to the next step.

## UniPilot Pro Deadband

Vehicle types that use an electro-mechanical device attached to the steering wheel, such as the UniPilot Pro, to control the direction the vehicle steers will use this procedure. There is a minimum amount of current that is required to start the UniPilot Pro to turn the wheel. The system needs to determine what this minimum current is. This process will slowly raise the signal sent to the UniPilot Pro then detect when the encoders in the UniPilot Pro detect motion. It will determine the deadband for turning to the right and left. It is important for the steering system to have this information so it can make slight, precise commands to turn the steering wheel.

*NOTE: Verify that the engine RPM is constant at the working speed while this part of the calibration is taking place.*

Follow the procedure below to complete the calibration.

1. Drive the vehicle in a straight line within the speed range 1.3 to 3.7 mph / 2.0 to 6.0 km/h.
2. Press **Resume** to begin the calibration process.
3. The vehicle will drive straight until the UniPilot Pro starts to move to the right and left slightly. Once the motion has been detected this step is complete and it will move on to the next step.

Figure 27: UniPilot Pro Deadband Calibration

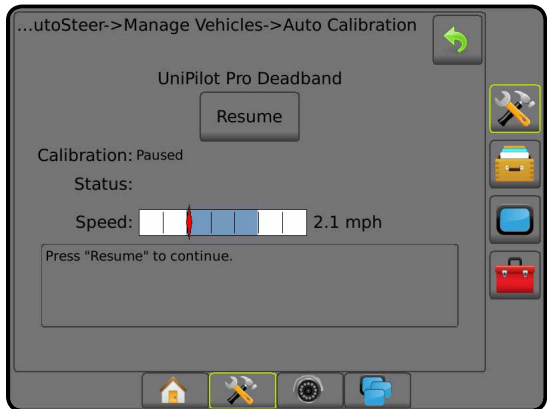

## UniPilot Pro

Vehicle types that use an electro-mechanical device attached to the steering wheel, such as the UniPilot Pro, to control the direction the vehicle steers will use this procedure. This procedure will test the rate of turn measured by the encoder inside the UniPilot Pro as the system sends various signals to it. The stronger the signal, the faster the UniPilot Pro should turn. This process will allow the system to know how large a signal to send to obtain a specific rate of turn.

Follow the procedure below to complete the calibration.

1. Drive the vehicle in a straight line within the speed range 1.3 to 3.7 mph / 2.0 to 6.0 km/h.
2. Press **Resume** to begin the calibration process.
3. The system will command the steering wheel to turn left and right at different speeds.
4. When the process is complete, the system will move on to the next step.

Figure 28: UniPilot Pro Calibration

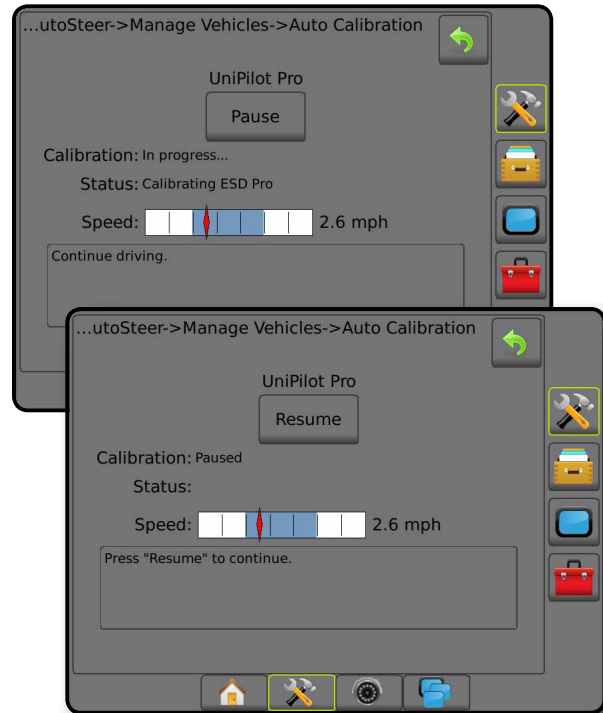

## Antenna Lateral Offset Distance Adjustment

A properly set up vehicle's center line should pass over the same point going in both direction on the same guidance line. This behavior is controlled by the Antenna Lateral Offset. During the initial vehicle setup, a rough estimate of the antenna offset is entered. After the vehicle profile has been created and the automatic calibration has been run, the operator should perform the following procedure to ensure that the Antenna Lateral Offset is entered correctly. This procedure will detect and eliminate skips and overlaps in adjacent rows due to an incorrect lateral offset.

*NOTE: Before the calibration process was started, the Antenna Lateral Offset value should be as close to zero as possible. If the value is off by more than 4 in / 10 cm, the calibration process will have to be redone after changing this value.*

*NOTE: Always verify that the implement selected during this test on the Display has a zero (0) offset even if there is no implement on the back of the vehicle. Any implement offsets will cause an incorrect measurement to be entered in this procedure.*

See "Antenna Lateral Offset Direction & Distance" for more information on this setting.

To calculate an antenna offset adjustment using the same guideline:

1. Create a straight AB line.
2. With assisted/auto steering engaged, drive pass ❶ at least 100 feet / 30 meters, and place flags at the draw bar or next to the machine.
3. Turn around and engage assisted/auto steering on pass ❷ on the same AB guideline. Place flags at the draw bar or next to the machine, or stop while on the AB guideline next to the flags you placed on pass ❶.
4. Measure the difference ❸ between the flags of pass ❶ and pass ❷.
5. Divide the measured distance ❸ in half. This difference will be the offset adjustment.
6. Increase or decrease the offset distance as needed dependent on where the field application overlap occurs and the current implement offset direction setting.

Field Application Overlap	Current Offset Settings		
	Offset Direction = Left	Offset Direction = Right	Offset Direction = Right Offset Distance = 0 ft/m
To the right of pass ❶	Increase distance offset value	Decrease distance offset value	Increase distance offset value
To the left of pass ❶	Decrease distance offset value	Increase distance offset value	Change to implement offset direction to left and increase distance offset value

Figure 30: Antenna Lateral Offset Distance

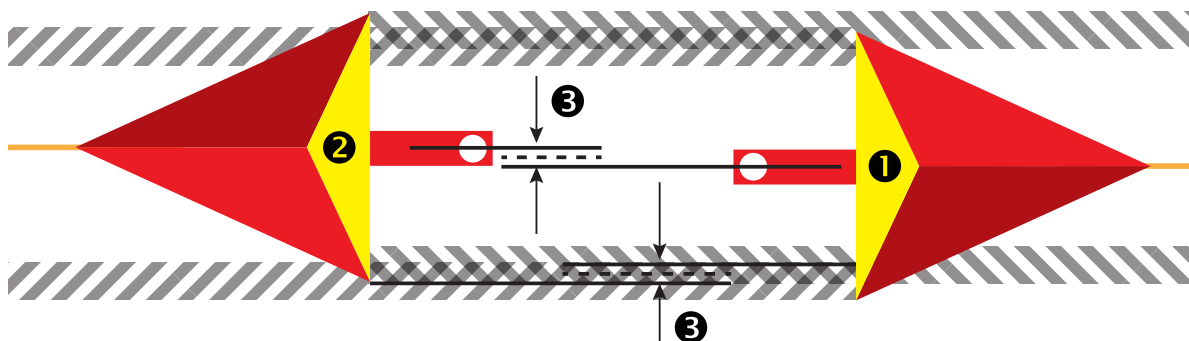
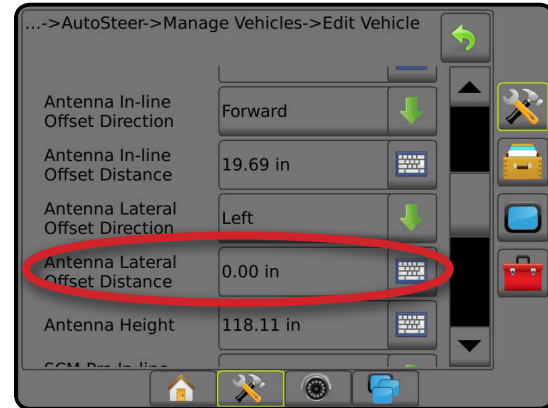

Figure 29: Antenna Lateral Offset Distance



## Vehicle Adjust

After the vehicle has been calibrated, it should perform adequately for most normal field operations. However in some situations, it may be necessary to adjust the steering performance to take into account field conditions, implement selection, traveling speed, etc. The Vehicle Adjust screen enables the operator to adjust the vehicle steering performance to match these changing conditions.



1. Select **Manage Vehicles** on the FieldPilot Pro / UniPilot Pro screen.
2. Press **Adjust**.
3. Setup each option in the following order (as available):
  - ❶ Manual Disengage – Adjust the limit at which FieldPilot Pro or UniPilot Pro is disengaged when the steering wheel is being turned manually
  - ❷ Motor Aggressiveness [UniPilot Pro only] – Adjust how aggressively the UniPilot Pro turns the steering wheel. Range is 1 through 20.
  - ❸ UniPilot Pro Freeplay [UniPilot Pro only] – Adjust for freeplay in the vehicle steering. The value represents steering wheel movement without tire movement. Range is 1 through 20.
  - ❹ Steering Response – Adjust the oscillations of vehicle when it is on the desired path. Range is 1 through 20.
  - ❺ Heading Aggressiveness – Adjust how aggressively the vehicle reacts to changes in the vehicles heading. Range is 1 through 20.
  - ❻ Cross Track Error – Adjust how aggressively the vehicle reacts to changes in cross track error (the vehicle's lateral offset from the selected pass). Range is 1 through 20.
  - ❼ Line Acquisition – Adjust how aggressively the vehicle acquires the line. The goal is to adjust the system to take the shortest route without excessively sharp or sudden movements of the vehicle. Range is 1 through 20.
  - ❽ Reverse Response – Adjust steering aggressiveness when the vehicle is traveling in reverse. Range is 1 through 20.
  - ❾ Tilt Calibration – Recalibrate the Tilt Calibration. Follow instructions on screen to position and reposition your vehicle. This option is available only after the active vehicle has completed the initial calibration. For more information, see “Tilt Zero Calibration” in the Automatic Calibration section of this manual.
  - ❿ Wheel Angle Sensor (WAS) Calibration – Recalibrate the Angle Sensor calibration. This option is available only after the active vehicle has completed the initial calibration. For more information, see “Angle Sensor” in the Automatic Calibration section of this manual.
4. Press RETURN arrow  to return to the FieldPilot Pro / UniPilot Pro screen or CONFIGURATION side tab  to return to the main Configuration screen without committing the changes.

Figure 31: Vehicle Adjust



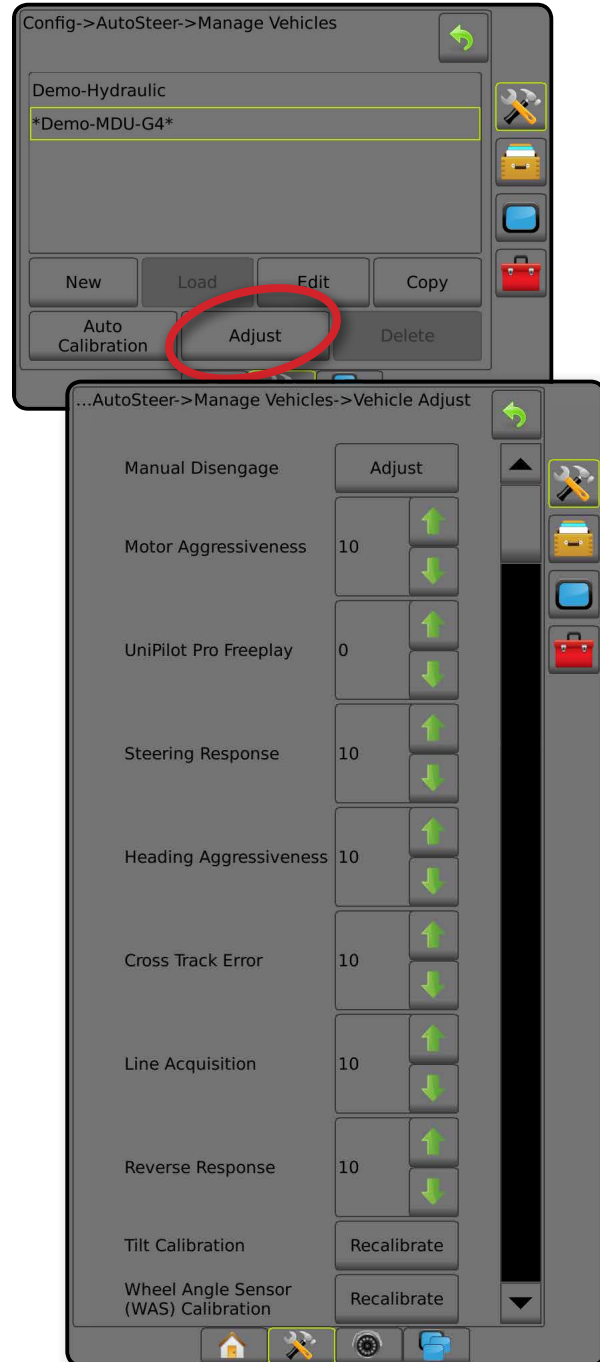

## Vehicle Adjust Options

### Steering Response

Adjust the oscillations of vehicle when it is on the desired path.

Figure 32: Steering Response

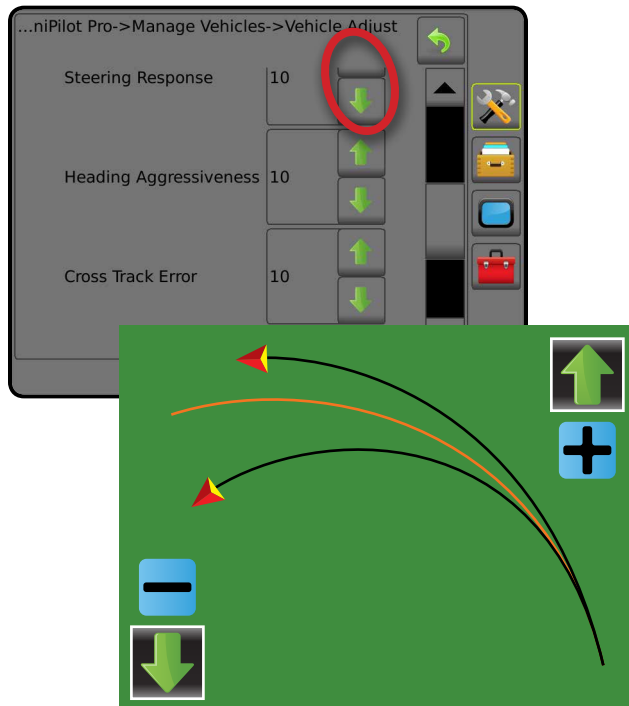

### Cross Track Error

Adjust how aggressively the vehicle reacts to changes in cross track error (the vehicle's lateral offset from the selected pass).

Figure 34: Cross Track Error

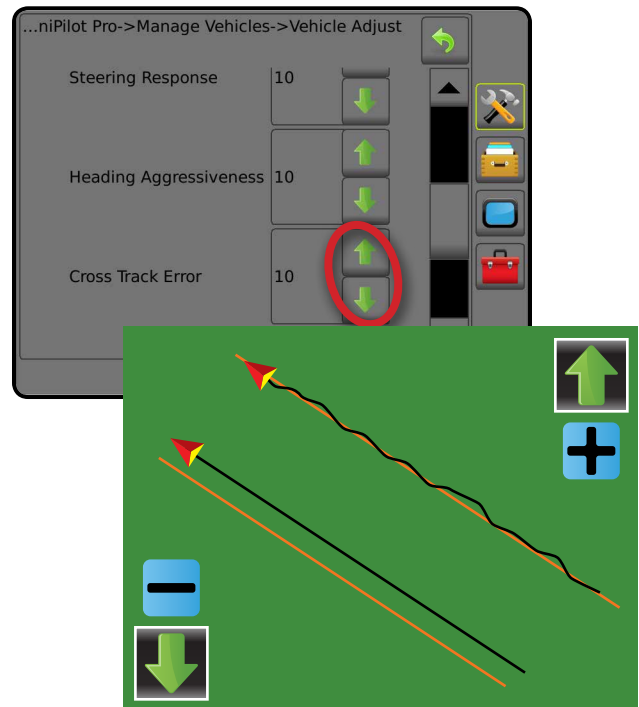

### Heading Aggressiveness

Adjust how aggressively the vehicle reacts to changes in the vehicles heading.

Figure 33: Heading Aggressiveness

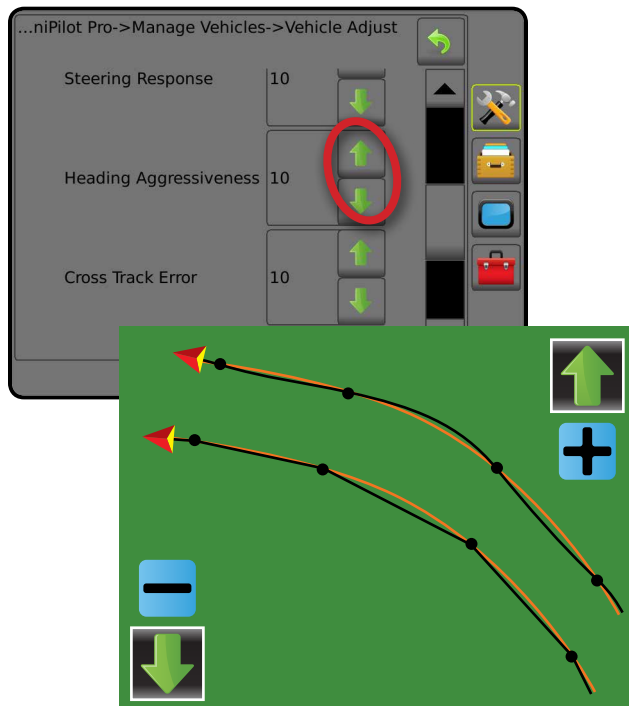

### Line Acquisition

Adjust how aggressively the vehicle acquires the line. The goal is to adjust the system to take the shortest route without excessively sharp or sudden movements of the vehicle.

Figure 35: Line Acquisition

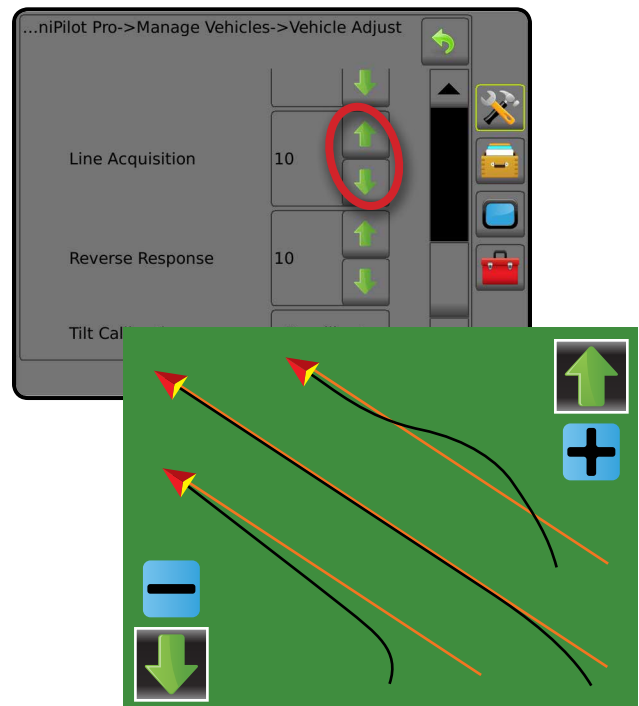

## CHAPTER 3 – FIELDPILOT PRO OR UNIPILOT PRO ON GUIDANCE SCREENS

FieldPilot Pro or UniPilot Pro and Tilt information can be easily accessed from the Status Bar on the Guidance Screens.

### Assisted/Auto Steering Status



Assisted/Auto Steering Status displays information regarding the current status of the assisted/auto steering system, including tilt status.

1. Press ASSISTED/AUTO STEERING STATUS icon   .

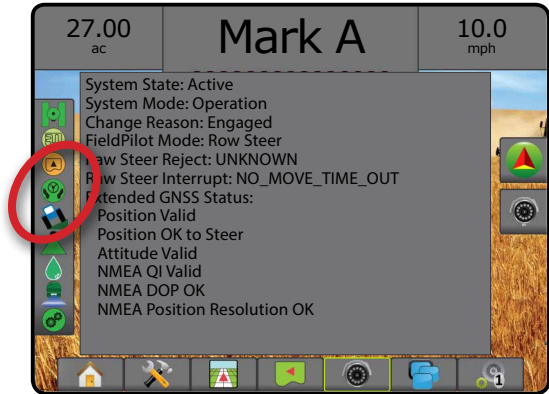
Figure 36: Assisted/Auto Steering Status







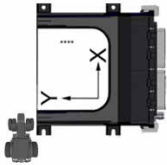
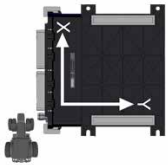
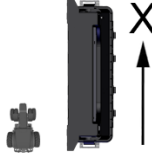

### Assisted/Auto Steering Status

-  Green = engaged, actively steering
-  Yellow = enabled, all conditions have been met to allow for assisted/auto steering
-  Red = disabled, all conditions have not been met to allow for assisted/auto steering
- No Icon = no assisted/auto steering system installed

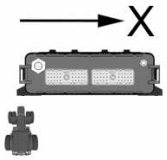
## APPENDIX

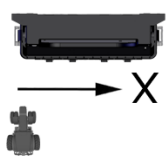
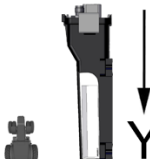
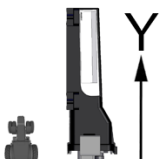
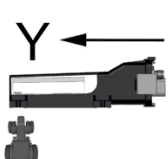
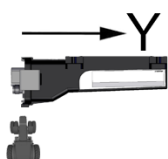
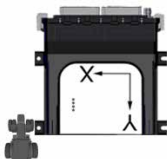
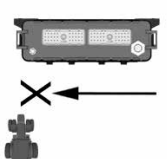
### Orthogonal Orientations

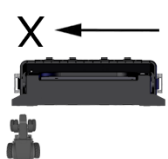
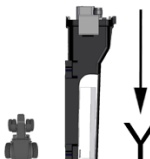
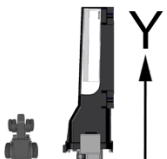
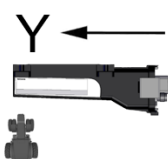
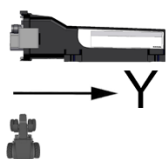
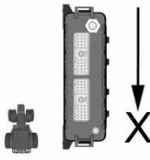
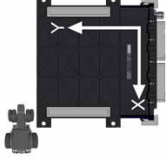
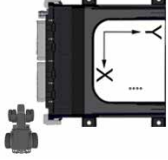
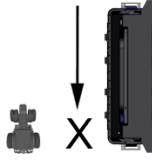
 <p>X: Front, Y: Down</p>	 <p>X: Front, Y: Left</p>	 <p>X: Front, Y: Right Base Orientation Position with (X=0, Y=0, Z=0)</p>	 <p>X: Front, Y: Up</p>
 <p>X: Right, Y: Back</p>	 <p>X: Right, Y: Down</p>	 <p>X: Right, Y: Front</p>	 <p>X: Right, Y: Up</p>
 <p>X: Down, Y: Back</p>	 <p>X: Down, Y: Front</p>	 <p>X: Down, Y: Left</p>	 <p>X: Down, Y: Right</p>
 <p>X: Left, Y: Back</p>	 <p>X: Left, Y: Down</p>	 <p>X: Left, Y: Front</p>	 <p>X: Left, Y: Up</p>
 <p>X: Up, Y: Back</p>	 <p>X: Up, Y: Front</p>	 <p>X: Up, Y: Left</p>	 <p>X: Up, Y: Right</p>
 <p>X: Back, Y: Down</p>	 <p>X: Back, Y: Left</p>	 <p>X: Back, Y: Right</p>	 <p>X: Back, Y: Up</p>

## Vehicle Profile Worksheet

Please use this form to write down MFWD vehicle information before creating the new vehicle. Please contact your AutoSteer Pro dealer for forms adequate for other vehicle types

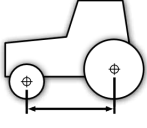
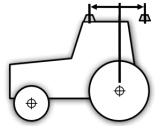
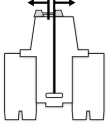
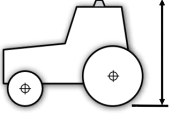
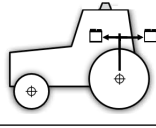
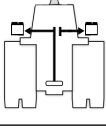
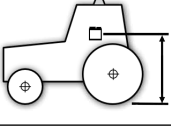
Vehicle Type	Vehicle Make	Vehicle Model	Controller Type
			<input type="checkbox"/> UniPilot Pro <input type="checkbox"/> Hydraulic
Vehicle Name	Units Used		Wheel Base
	<input type="checkbox"/> Meters [m] <input type="checkbox"/> Centimeters [cm] <input type="checkbox"/> Feet [ft] <input type="checkbox"/> Inches [in]		
		Measurements:	
GNSS Antenna Location	Fore / Aft	Left / Right	Height
			
Measurements:	<input type="checkbox"/> Fore <input type="checkbox"/> Aft	<input type="checkbox"/> Left <input type="checkbox"/> Right	
SCM Pro Location	Fore / Aft	Left / Right	Height
			
Measurements:	<input type="checkbox"/> Fore <input type="checkbox"/> Aft	<input type="checkbox"/> Left <input type="checkbox"/> Right	
SCM Pro Orientation	X Axis	Y Axis	Z Axis
Angle Measurements If Tilted [deg]:			

## Transferring SCM Pro from One Vehicle to Another

The FieldPilot Pro system or UniPilot Pro system is designed to be easily transferred from one vehicle to another. Specific vehicle kits are available that can be installed on each vehicle so that only the Display, GNSS Receiver, and the SCM Pro need to be transferred. Each vehicle that the FieldPilot Pro system or UniPilot Pro system is to be transferred to should have the Display Harness, SCM Pro Main Harnesses, and Vehicle Harnesses already installed. Contact your AutoSteer Pro dealer for information about obtaining and installing additional vehicle specific kits. Use the instructions in this section to transfer the SCM Pro from one vehicle to another. Refer to the Aeros or Matrix Pro GS manuals for instruction on moving them.

Figure 37: SCM Pro Installation Diagram

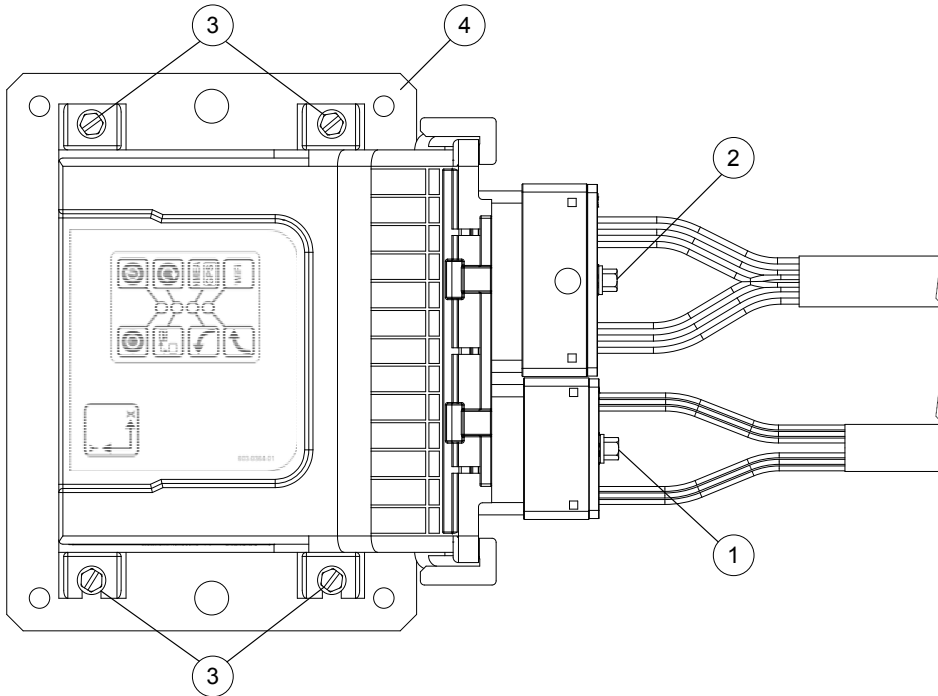

The figure above shows SCM Pro installed on the metal bracket with main and vehicle specific harnesses connected.

Table 5: SCM Pro Installation

Item	Description
1	Main Harness connector
2	Vehicle Specific Harness connector (optional, depends on installation)
3	Four 8-32 x 1/2 hex mounting screws
4	Metal bracket

### Tools Required

To remove SCM Pro from one vehicle and install it in another vehicle only one tool is required: 1/4 inch nut driver.

### Removing the SCM Pro from a Vehicle

1. Turn off and disconnect power from the FieldPilot Pro system or UniPilot Pro system .
2. Disconnect the Main Harness connector from the SCM Pro by unscrewing the hex screw on the connector.
3. If present, disconnect the Vehicle Specific Harness connector from the SCM Pro by unscrewing the hex screw on the connector.
4. Remove the four SCM Pro mounting screws. This releases the SCM Pro from the vehicle mounting bracket so it can be moved to another vehicle. Keep the screws safe for future use.
5. Remove the Display from the cab using the instructions provided in the Display Operator's Manual.
6. Remove GNSS Receiver using the instructions provided in the GNSS Receiver Operator's Manual.

## Installing the SCM Pro on to a Vehicle

1. Disconnect power from the FieldPilot Pro system or UniPilot Pro system harness.
2. Install the Display in the cab using the instructions provided in the Display Operator's Manual.
3. Install the GNSS Receiver using the instructions provided in the GNSS Receiver Operator's Manual.
4. Attach the SCM Pro to the mounting bracket with four 8-32 x 1/2 hex screws.

*NOTE: For proper operation the SCM Pro must be firmly attached to the vehicle. It must be mounted on the metal bracket to allow heat dissipation. Do not over-tighten the screws.*

5. Attach the SCM Pro Main Harness connector to the smaller connector on the SCM Pro and tighten the screw.
6. If present, attach the Vehicle Specific Harness connector to the larger connector on the SCM Pro and tighten the screw.

*NOTE: If the vehicle does not have a Vehicle Specific Harness to plug into that connection, verify that the Dummy plug is attached to keep dust out of the connector and to prevent damage to the pins and or hardware inside.*

*NOTE: Both connectors are keyed so they will only fit the proper receptacle of the SCM Pro and in one orientation. The connectors should slide easily onto the receptacle. If they do not slide easily, check if the plug matches receptacle, there is no obstacle inside and pins are not bent. Do not force the connector into the receptacle as this could damage the connectors.*

7. Power up the FieldPilot Pro system or UniPilot Pro system and navigate to the AutoSteer Pro Setup screen. Use the Manage Vehicles button to select and activate the vehicle that the FieldPilot Pro system or UniPilot Pro system has been installed on. Refer to the Manage Vehicle section for information on setting the active vehicle.

## Display Connections

The FieldPilot Pro system or UniPilot Pro system should be connected to the Aeros or Matrix Pro GS system using the appropriate main harness.

Some technical support programming or troubleshooting requires a wired or wireless connection directly to the SCM Pro. Wired connections would use Ethernet Interface RJ45 to Conxall Cable. The wireless connection uses IEEE 802.11 b/g WiFi. Service Mode needs to be enabled to connect directly to the SCM Pro.

Consumer tablet or laptop PC can access the SCM Pro Setup screens directly via a web browser. If using Ethernet, connect RJ45 cable to your computer and type 10.1.1.1 in the web page address line. If using WiFi, connect to SCM Pro -XXXX wireless network access point, where XXXX are last four digits of SCM Pro serial number and type 10.100.100.100 in the web page address line.

Figure 38: Display Connections

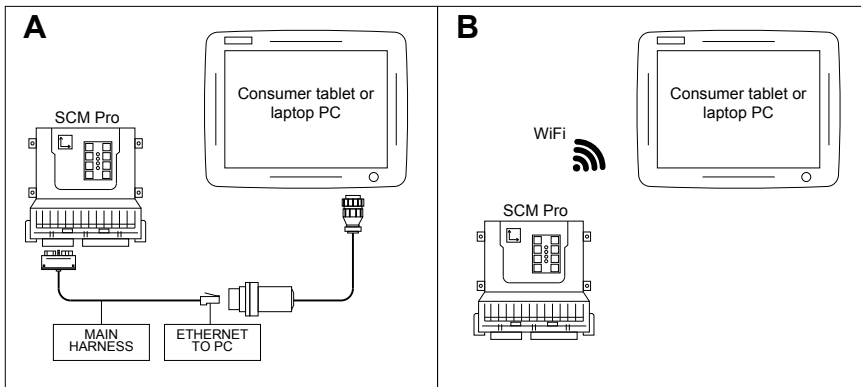



# FieldPilot® Pro & UniPilot® Pro

## USER MANUAL

---

### **Adaptable to Your Field Conditions and Your Location**

FieldPilot Pro & UniPilot Pro uses the very latest technology to compensate for rough terrain and tough field conditions. Three different sensors each measure machine dynamics in three axes - that means 9 axes of measurements happening hundreds of times each second.

Additionally, the FieldPilot Pro system & UniPilot Pro system can be equipped with a steering angle sensor to further improve accuracy.

FieldPilot Pro & UniPilot Pro are also ready to take advantage of any level of GNSS accuracy. Higher levels of GNSS accuracy will always improve steering accuracy, but stable, reliable steering is available with basic SBAS (WAAS or EGNOS) GNSS receivers. From autonomous to RTK, choose the level of GNSS precision needed for your application, and FieldPilot Pro & UniPilot Pro will steer the machine with accuracy, every time.



[www.teejet.com](http://www.teejet.com)

A Subsidiary of  **Spraying Systems Co.**

98-05341-ENUS-LT R0 English-US  
© TeeJet Technologies 2016

