

# TeeJet®

TECHNOLOGIES

## CATALOG 52







# SPRAYSELECT TIP SELECTION APP

## SPRAY SOLUTIONS AT A TOUCH OF A BUTTON

SpraySelect allows you to quickly and easily choose the proper tip for your application. Just enter spacing, speed, and your target rate, select your droplet size category, and a list of top recommendations is provided.

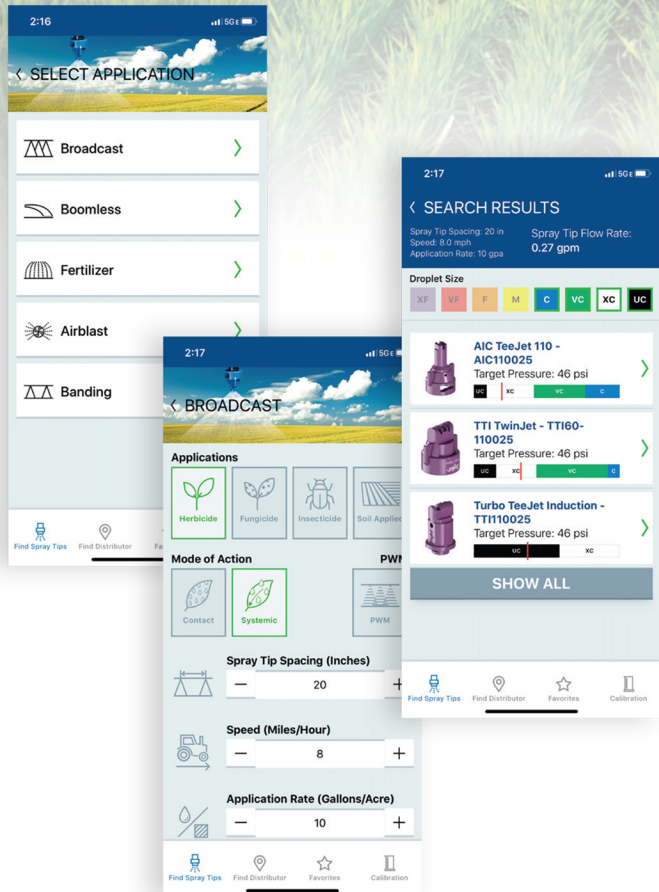
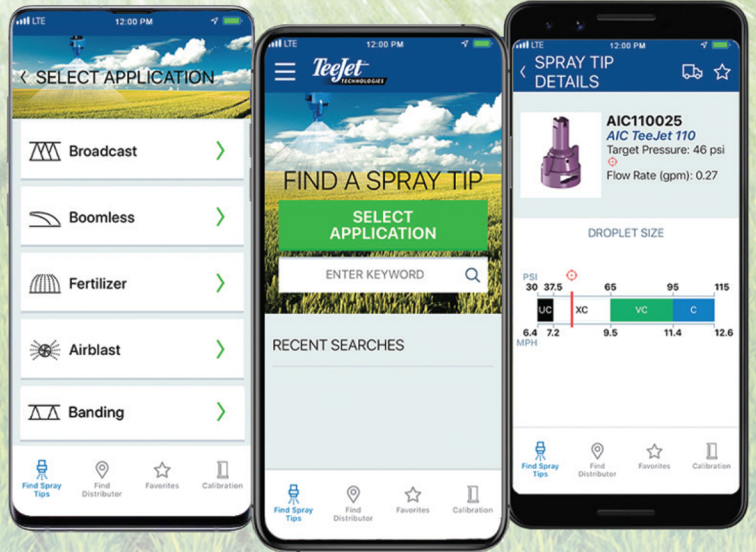

## APP FEATURES

- Find Spray Tips
  - Tip Spacing
  - Speed
  - Application Rate
  - Select Droplet Size
- Select Application
- Save Favorites
- Find Distributors Nearby
- Spray Tip Calibration

SCAN QR OR DOWNLOAD

Download on the App Store

ANDROID APP ON Google play





# TABLE OF CONTENTS

**CATALOG 52 NEW PRODUCTS**

4-5

**SELECTION GUIDE**

6-10

**PWM SPRAY TIP SELECTION GUIDE**

11-13

**BROADCAST NOZZLES**

14-57

**BOOMLESS NOZZLES**

58-63

**BANDING NOZZLES**

64-79

**AIR BLAST NOZZLES**

80-91

**FERTILIZER NOZZLES**

92-104

**TANK RINSING NOZZLES**

105-106

**ELECTRONICS**

107-117

**BOOM COMPONENTS**

118-143

**VALVES & MANIFOLDS**

144-165

**STRAINERS**

166-169

**SPRAY GUNS**

170-178

**TECHNICAL INFORMATION**

179-202

VISIT **TEEJET.COM**

COMPANY NEWS

TECHNICAL SUPPORT

PRODUCT  
INFORMATION

WHERE  
TO BUY

IMAGE LIBRARY





# KEY NEW PRODUCTS

## IN CATALOG 52

### 530A PLUNGER VALVES & MANIFOLDS PG 154-155

The compact 530A series of valves and manifolds provide a highly-configurable and versatile platform of products for sprayer operation. The 530A is available with manual or electric section control valves and is compatible with a wide range of existing and future accessory products. Manual and electric valves share a universal actuator attachment, allowing manual valves to be easily upgraded to electric operation. These plunger valves can be especially effective in applications using wettable powders or suspensions, where residues and buildup from inadequate flushing can be problematic.



### MATRIX® 908 PG 108-109

Matrix 908 is built for expandability, rugged performance, and easy operation in many agricultural and turf applications. The Matrix 908 offers a bright, clear display, intuitive menu structure and long-lasting construction.



### INDIVIDUAL SPRAY NOZZLE CONTROL VALVES PG 134

DynaJet®, DynaJet® HF, and EcoStop Valves are an essential part of a smart spraying system. TeeJet® solenoid valves are electronically controlled shutoffs that facilitate your precision spraying strategy more efficiently and sustainably, resulting in greater accuracy, increased yields, and less waste.



### VARIABLE RATE NOZZLES PG 94-95, 98-101

The new VR line of Variable Rate fertilizer StreamJet spray tips and metering bodies feature a flexible metering orifice that produces a much wider range of flow rates across standard operating pressures than can be achieved with fixed orifice nozzles. This allows for a wider range of ground speeds and/or application rates from a single orifice for improved productivity. They are also ideal for variable rate, prescription application. That flexible elastomer orifice provides consistent flow rate performance while utilizing a simple, reliable design with no springs or moving parts.



PG 94-95

PG 98-99

PG 100-101

PG 100-101

### CERAMIC TIPS PG 16-19

TeeJet now manufactures many popular TeeJet spray tip models with ceramic orifices in polypropylene tip bodies. These products provide outstanding resistance to wear and exceptional resistance to aggressive chemistries. Turbo TeeJet and AIXR TeeJet are the newest additions to the ceramic family.



PG 16-17

PG 18-19



## ACCUPULSE® TWINJET® TIPS PG 14-15

The AccuPulse (APTJ) uses a non-air induction design, to produce highly drift resistant XC and UC droplets with twin fan sprays for optimal performance in Pulse Width Modulation (PWM) control applications. The compact size and choice of numerous capacities will suit the needs of a wide range of application rates. APTJ tips are ideal for many uses in PWM controlled applications and are also suitable for use on conventional sprayers.



## QUICK TEEJET® CAPS PG 118-119

Quick TeeJet caps continue to offer fast, convenient installation or replacement of spray tips. Updated caps are now available in a variety of the most popular styles and colors, feature a cleaner design, and are constructed of acetal.



## QJ370 MULTIPLE NOZZLE BODY PG 124

The QJ370 multiple nozzle body features a compact design to fit onto a variety of sprayers and boom designs. QJ370 nozzle bodies are available for wet boom and dry boom installations. It has positive indexing that prevents accidental rotation. Optimized internal passages provide high flow rates for a wide range of ground speeds and application rates.



## QJS STACKABLE NOZZLE BODIES PG 120-123

The QJS multiple outlet, stackable nozzle body takes nozzle body versatility to a new level for both pull-type and self-propelled sprayers. The QJS is offered in three wet boom configurations, side or bottom inlet, with a choice of two, three, or four outlets. New options include integral flowmeter and high-strength stainless steel inlet tube. The QJS body can be equipped with any combination of TeeJet tip shutoffs including—pneumatic, electric, manual or spring-loaded check valve.



## XE BOOMLESS SPRAY TIP PG 62-63

The XE Extended Even Boomless Spray Tip is a wide, even spray pattern for fewer passes through the field and the ability to cover more area with each pass. They can be used in a variety of handheld or mechanized applications—such as fruits & vegetables, greenhouses, home gardens, urban pest control, sugar cane, and flowers.



## TTI TWINJET® TIPS PG 26-27

The TTI60 TwinJet air induction twin flat spray tip provides coarse to ultra coarse droplet size for maximum drift control along with the improved coverage of a twin spray. The single piece tip and cap design allows for fast, easy installation and, unlike some other twin sprays, has a very compact size. The TTI60 is ideal for the application of soil applied and systemic herbicides.





# TeeJet® SPRAY TIP SELECTION FOR CROPS

Crop protection product application in crops occurs at different growth stages. The right spray tip selection will result in maximum coverage and efficacy while reducing drift. TeeJet has several spray tips that provide the perfect balance of coverage and drift reduction. Check out some examples of TeeJet spray tips that most suit applications in corn, soybean, and wheat.

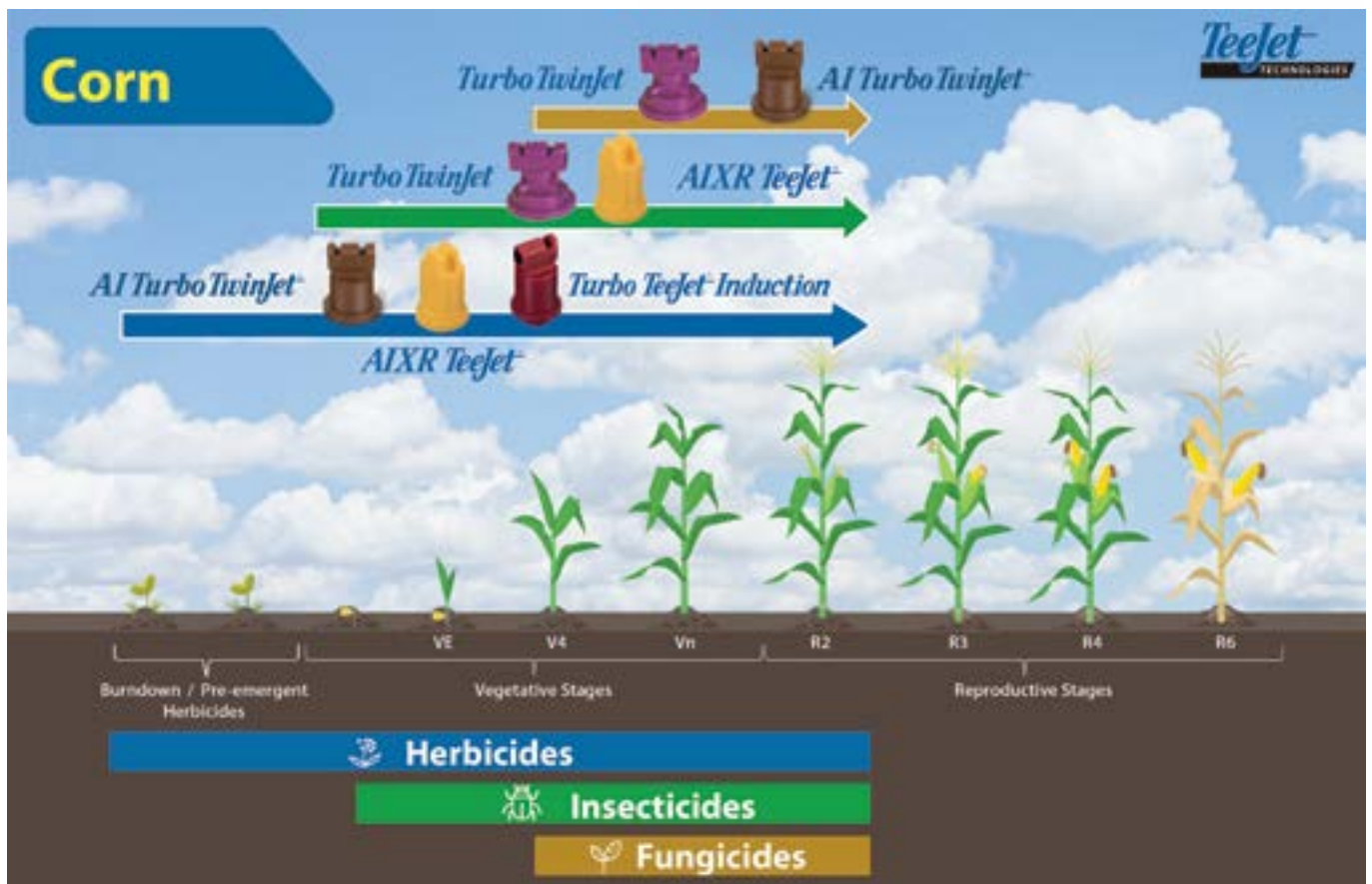



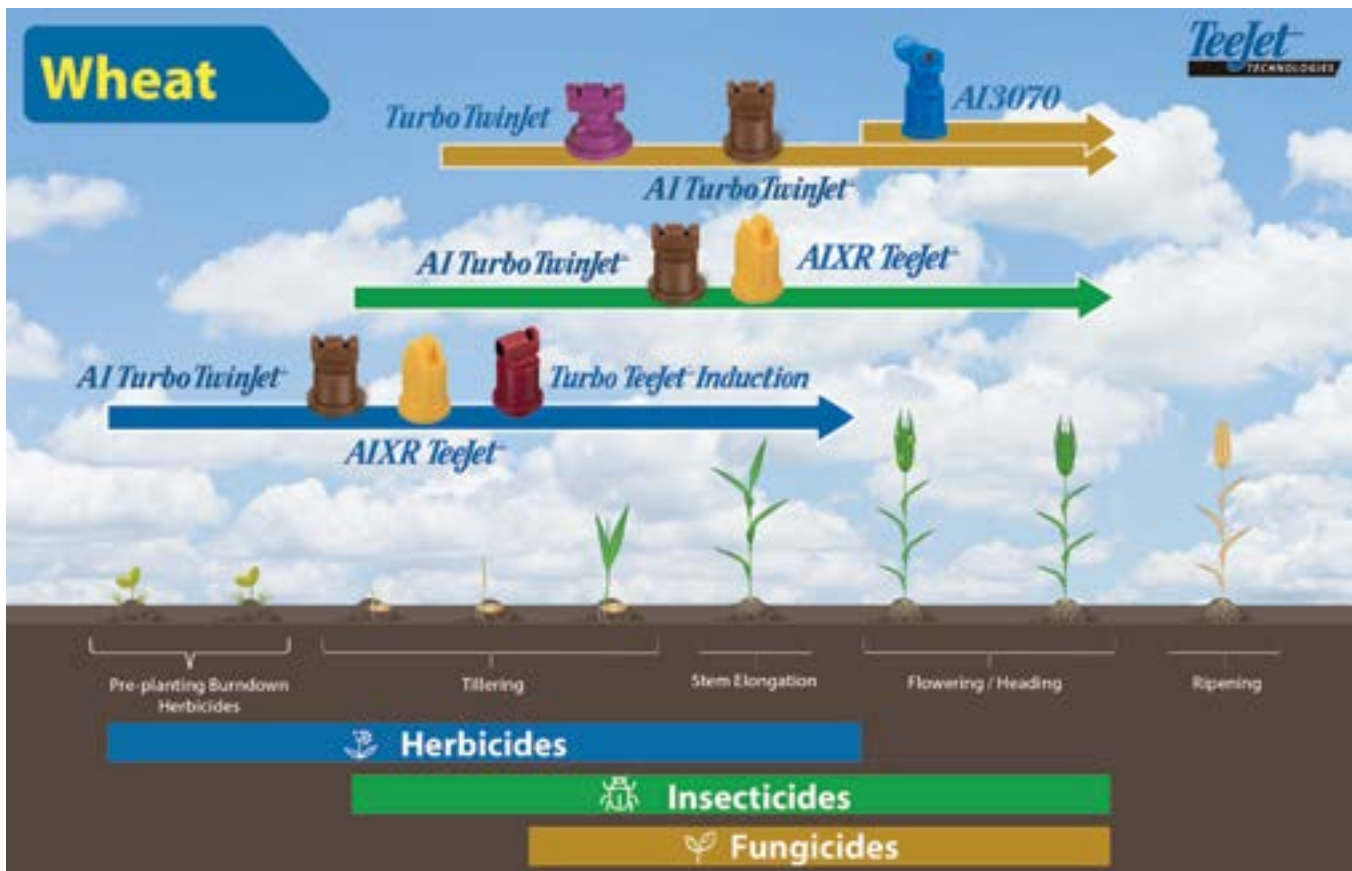
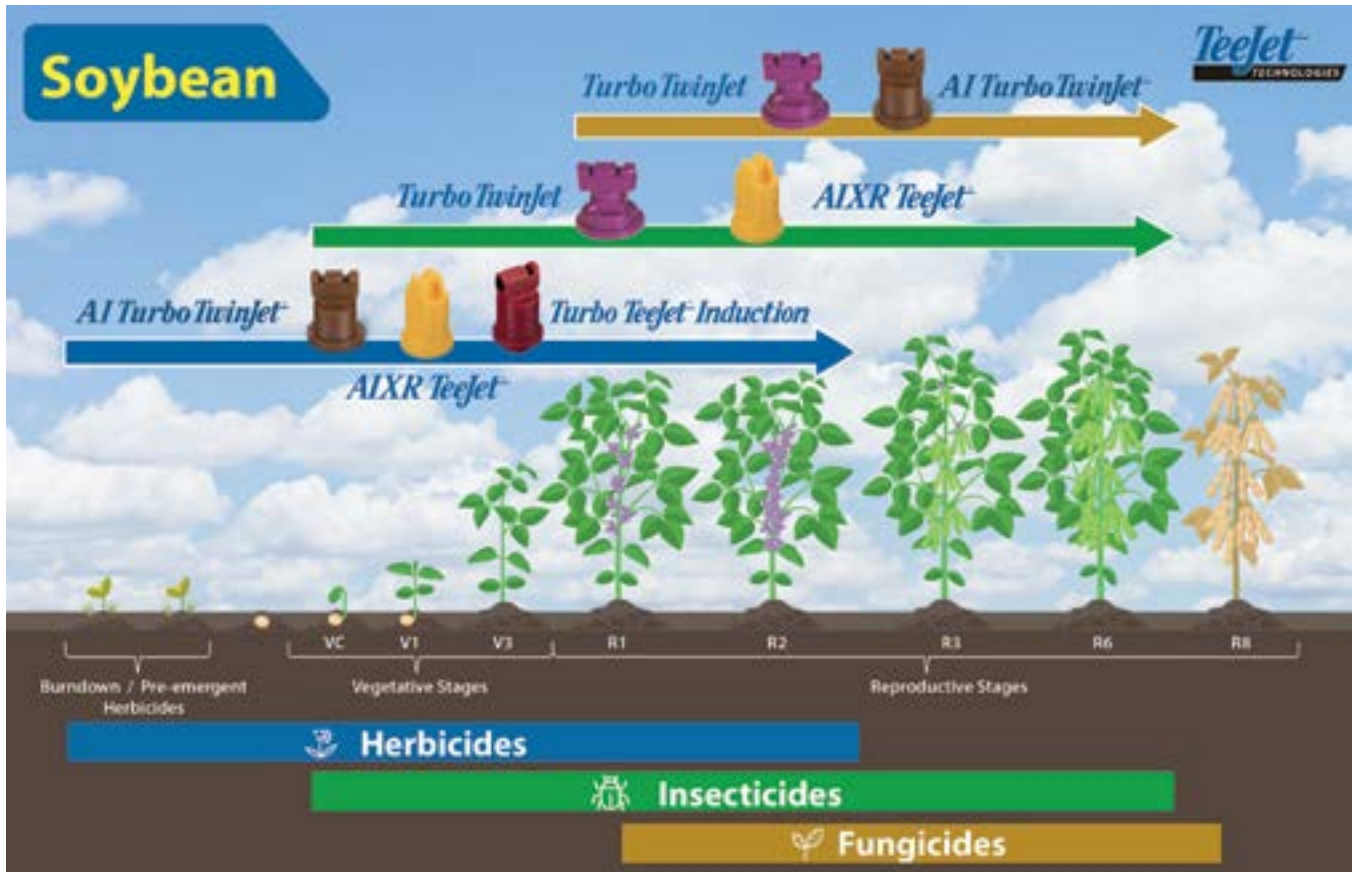



<b>SPRAY TIPS &amp; DROPLET SIZE*</b> 	<b>HERBICIDES</b>		<b>FUNGICIDES</b>		<b>INSECTICIDES</b>		
	<b>SOIL APPLIED</b>	<b>POST-EMERGENCE</b>		<b>CONTACT</b>	<b>SYSTEMIC</b>	<b>CONTACT</b>	<b>SYSTEMIC</b>
		<b>CONTACT</b>	<b>SYSTEMIC</b>				
<b>AccuPulse TwinJet<sup>+</sup></b> APTJ Pages 14–15	EXCELLENT		EXCELLENT				
<b>Turbo TeeJet<sup>+</sup></b> TT Pages 16–17		EXCELLENT	VERY GOOD	EXCELLENT	VERY GOOD	EXCELLENT	VERY GOOD
<b>AI XR TeeJet<sup>+</sup></b> AI XR Pages 18–19	VERY GOOD	EXCELLENT	VERY GOOD	GOOD	VERY GOOD	VERY GOOD	EXCELLENT
<b>Air Induction TeeJet<sup>+</sup></b> AI & AIC Pages 20–23	VERY GOOD		EXCELLENT		GOOD		VERY GOOD
<b>Turbo TeeJet Induction</b> TTI Pages 24–25	EXCELLENT		EXCELLENT				
<b>TTI TwinJet<sup>+</sup></b> TT160 Pages 26–27	EXCELLENT		EXCELLENT				
<b>XR, XRC TeeJet<sup>+</sup></b> XR & XRC Pages 28–31		VERY GOOD	GOOD	EXCELLENT	GOOD	EXCELLENT	GOOD
<b>Turbo TwinJet<sup>+</sup></b> TTJ60 Pages 36–37	GOOD	EXCELLENT	VERY GOOD	EXCELLENT	VERY GOOD	EXCELLENT	VERY GOOD
<b>AI Turbo TwinJet<sup>+</sup></b> AITTJ60 Pages 38–39	VERY GOOD	VERY GOOD	EXCELLENT	GOOD	EXCELLENT	GOOD	EXCELLENT
<b>AI3070<sup>+</sup></b> AI3070 Pages 40–41				EXCELLENT	VERY GOOD		
<b>StreamJet</b> SJ3 & SJ3-VR Pages 92–95							
<b>StreamJet</b> SJ7A & SJ7A-VR Pages 96–99							
<b>StreamJet</b> PTC-VR & QJ-VR Pages 100–101							
<b>StreamJet</b> SOLID STREAM Pages 104							

**Note:** Consult the chemical manufacturer's product label for specific rate and application recommendations. Droplet size categories shown are based on ISO 25358.  
 \*(XF) Extremely Fine, (VF) Very Fine, (F) Fine, (M) Medium, (C) Coarse, (VC) Very Coarse, (XC) Extremely Coarse, (UC) Ultra Coarse

FERTILIZER		 DRIFT CONTROL	 PWM APPROVED
 BROADCAST	 DIRECTED		
EXCELLENT		EXCELLENT	✓
EXCELLENT		GOOD	✓
		VERY GOOD	
VERY GOOD		EXCELLENT	
EXCELLENT		EXCELLENT	✓
EXCELLENT		EXCELLENT	✓
		GOOD	✓
		VERY GOOD	✓
		EXCELLENT	✓
		VERY GOOD	
EXCELLENT		EXCELLENT	
EXCELLENT		EXCELLENT	
	EXCELLENT	EXCELLENT	
	EXCELLENT	EXCELLENT	

## LIQUID FERTILIZER APPLICATION

Just as in applying crop protection products, the proper application of liquid fertilizer is important. Delivering nutrients to the crop in a timely and effective manner while minimizing crop damage is essential. TeeJet Technologies offers an extensive selection of spray tips specifically designed to maximize the performance of your liquid fertilizer application.

Solid stream nozzles, offered in both single and multiple-stream versions, are designed to deliver fertilizer to the soil surface where it can be effectively utilized by the crop. By creating solid liquid streams, these tips greatly reduce foliar coverage in standing crop in order to minimize leaf burn. TeeJet Technologies StreamJet tips provide the ideal blend of compact, reliable design, ease of installation and affordable pricing.

In some cases, the use of a broadcast nozzle for fertilizer application may be desirable. This could include combined fertilizer/pesticide applications, foliar feeding or broadcast liquid fertilization of bare ground. For these applications TeeJet Technologies offers a wide variety of low drift, flat spray tips.

## LIQUID DENSITY CONVERSION

When selecting a specific capacity tip for liquid fertilizer application, always correct for liquid density. Application charts shown in this catalog are based on spraying water. Many fertilizer solutions are denser than water, which will affect the application rate. Please see page 185 for a list of density conversion factors.



### EXAMPLE

Desired application rate is 20 GPA of 28% Nitrogen. Determine the correct nozzle size as follows:

$$\text{GPA (liquid other than water)} \times \text{Conversion Factor} = \text{GPA}^*$$

$$20 \text{ GPA (28\%)} \times 1.13 = 22.6 \text{ GPA (water)}$$

The applicator should choose a tip size that will supply 22.6 GPA of water at the desired pressure.

\*From table in catalog.





		HERBICIDES			FUNGICIDES		INSECTICIDES	
		SOIL APPLIED	POST-EMERGENCE		CONTACT	SYSTEMIC	CONTACT	SYSTEMIC
			CONTACT	SYSTEMIC				
BANDING	 <b>XE TeeJet</b> Pages 62–63	EXCELLENT		EXCELLENT		GOOD		GOOD
	 <b>AI TeeJet</b> <small>EVEN</small> Pages 64–65	VERY GOOD		EXCELLENT		GOOD		VERY GOOD
	 <b>TeeJet</b> <small>EVEN</small> Pages 68–69	EXCELLENT	VERY GOOD	GOOD	EXCELLENT	GOOD	EXCELLENT	GOOD
	 <b>TwinJet</b> <small>EVEN</small> Pages 70–71		VERY GOOD		VERY GOOD		VERY GOOD	
DIRECTED SPRAYING	 <b>AI TeeJet</b> <small>EVEN</small> Pages 64–65	VERY GOOD		EXCELLENT		EXCELLENT		EXCELLENT
	 <b>TeeJet</b> <small>EVEN</small> Pages 68–69	EXCELLENT	VERY GOOD	GOOD	EXCELLENT	GOOD	EXCELLENT	GOOD
	 <b>TwinJet</b> <small>EVEN</small> Pages 70–71		VERY GOOD		VERY GOOD		VERY GOOD	
	 <b>AIUB TeeJet</b> Pages 72–73		GOOD	EXCELLENT				GOOD
	 <b>ConeJet</b> Pages 78–79				EXCELLENT	VERY GOOD	EXCELLENT	VERY GOOD
AIR BLAST	 <b>TXR ConeJet</b> Pages 84–85				EXCELLENT	GOOD	EXCELLENT	GOOD
	 <b>AITX ConeJet</b> Pages 86–87		GOOD	EXCELLENT	VERY GOOD	EXCELLENT	VERY GOOD	EXCELLENT
	 <b>Disc-Core</b> Pages 89–91				EXCELLENT	GOOD	EXCELLENT	GOOD

**Note:** Consult the chemical manufacturer's product label for specific rate and application recommendations.

# MAKE EVERY DROP COUNT WITH YOUR PWM CONTROL



PWM spray tip control systems, like DynaJet®, use a PWM (Pulse Width Modulation) valve located at the nozzle body to adjust spray tip flow rate when changes in speed are detected. Spray tips that are paired with PWM controls are serving two main purposes—the formation of the spray pattern and droplet size. Target droplet size selection should be based on providing sufficient coverage for proper control while balancing out needs for drift management.

With air induction tips air is mixed with water through a venturi air aspirator that produces large air-filled droplets. When a PWM valve is used in conjunction with certain air induction tips, the mixing chamber and air inlet can fill with water as the PWM valve cycles. This can then result in water escaping out the air inlet holes, which can lead to poor distribution. New designs in air-induction tips however, have been proven to work well with PWM valves and nozzle control systems.

## WHAT MAKES A TEEJET SPRAY TIP “PWM APPROVED”?

Based on a combination of field and laboratory testing, PWM approved spray tips must meet the following criteria at a variety of duty-cycles:

- Excellent spray distribution in the direction of travel
- Rapid and complete spray pattern formation
- Excellent spray distribution across the boom
- Skip-free application
- Droplet size consistency







# DYNAJET® PWM APPLICATION RATE CHARTS FOR SYSTEMS EQUIPPED WITH 115880 DYNAJET VALVES



15" TIP SPACING

SELECTION GUIDE

TIP SIZE	GAUGE PRESSURE (PSI)	30% MINIMUM DUTY CYCLE							SPEED RANGE (MPH)																		
		TJ60	XR/XRC	TT	TTJ60	AITTJ60	TTI60	TTI	APTJ*	5 GPA		7.5 GPA		10 GPA		12 GPA		15 GPA		17.5 GPA		20 GPA		25 GPA		30 GPA	
										MIN	MAX	MIN	MAX	MIN	MAX	MIN	MAX	MIN	MAX	MIN	MAX	MIN	MAX	MIN	MAX	MIN	MAX
11001	20		F	C						1.7	6	1.1	4	0.8	3	0.7	2	0.6	1.8	0.5	1.6	0.4	1.4	0.3	1.1	0.3	0.9
	30		F	M						2	7	1.4	5	1.1	4	0.9	3	0.7	2	0.6	2	0.5	1.8	0.4	1.4	0.4	1.2
	40		F	M						2	8	1.6	5	1.2	4	1.0	3	0.8	3	0.7	2	0.6	2	0.5	1.6	0.4	1.3
	50		F	M						3	9	1.7	6	1.3	4	1.1	4	0.9	3	0.7	2	0.7	2	0.5	1.7	0.4	1.5
	60		VF	M						3	10	2	6	1.4	5	1.2	4	1.0	3	0.8	3	0.7	2	0.6	2	0.5	1.6
	70			F	M					3	10	2	7	1.5	5	1.3	4	1.0	3	0.9	3	0.8	3	0.6	2	0.5	1.7
	80			F	F					3	11	2	7	1.7	6	1.4	5	1.1	4	1.0	3	0.8	3	0.7	2	0.6	1.8
	90			F	F					4	12	2	8	1.8	6	1.5	5	1.2	4	1.0	3	0.9	3	0.7	2	0.6	2
	110015	20		F	VC				UC	UC	3	9	1.7	6	1.3	4	1.1	4	0.9	3	0.7	2	0.7	2	0.5	1.7	0.4
30			F	C				UC	UC	3	10	2	7	1.5	5	1.3	4	1.0	3	0.9	3	0.8	3	0.6	2	0.5	1.7
40			F	M				UC	UC	4	12	2	8	1.8	6	1.5	5	1.2	4	1.0	3	0.9	3	0.7	2	0.6	2
50			F	M				UC	UC	4	13	3	9	2	7	1.7	6	1.3	4	1.2	4	1.0	3	0.8	3	0.7	2
60			F	M				UC	UC	4	14	3	10	2	7	1.8	6	1.4	5	1.2	4	1.1	4	0.9	3	0.7	2
70				F	M			VC	XC	5	16	3	11	2	8	2	7	1.6	5	1.4	5	1.2	4	1.0	3	0.8	3
80				F	F			VC	XC	5	17	3	11	2	8	2	7	1.7	6	1.4	5	1.2	4	1.0	3	0.8	3
90				F	F			VC	XC	5	18	4	12	3	9	2	8	1.8	6	1.6	5	1.4	5	1.1	4	0.9	3
11002		20		F	M	VC	C	XC	UC	UC	3	11	2	7	1.7	6	1.4	5	1.1	4	1.0	3	0.8	3	0.7	2	0.6
	30		F	M	C	C	VC	XC	UC	4	13	3	9	2	7	1.7	6	1.3	4	1.2	4	1.0	3	0.8	3	0.7	2
	40		F	M	M	M	VC	XC	UC	5	16	3	11	2	8	2	7	1.6	5	1.4	5	1.2	4	1.0	3	0.8	3
	50		F	M	M	M	VC	XC	UC	5	17	3	12	3	9	2	7	1.7	6	1.5	5	1.3	4	1.0	3	0.9	3
	60		F	M	M	M	VC	XC	UC	6	19	4	13	3	10	2	8	2	6	1.6	5	1.4	5	1.1	4	1.0	3
	70			F	M	M	C	VC	XC	6	21	4	14	3	10	3	9	2	7	1.8	6	1.5	5	1.2	4	1.0	3
	80			F	M	M	C	VC	XC	7	22	4	15	3	11	3	9	2	7	2	6	1.7	6	1.3	4	1.1	4
	90			F	M	M	C	VC	XC	7	24	5	16	4	12	3	10	2	8	2	7	1.8	6	1.4	5	1.2	4
	11025	20		M	VC	C	XC	UC	UC	UC	4	14	3	10	2	7	1.8	6	1.4	5	1.2	4	1.1	4	0.9	3	0.7
30			M	C	C	VC	XC	UC	UC	5	17	3	12	3	9	2	7	1.7	6	1.5	5	1.3	4	1.0	3	0.9	3
40			F	M	M	M	VC	XC	UC	6	20	4	13	3	10	2	8	2	7	1.7	6	1.5	5	1.2	4	1.0	3
50			F	M	M	M	VC	XC	UC	7	22	4	15	3	11	3	9	2	7	2	6	1.7	6	1.3	4	1.1	4
60			F	M	M	M	VC	XC	UC	7	25	5	16	4	12	3	10	2	8	2	7	1.8	6	1.5	5	1.2	4
70				F	M	M	C	VC	XC	8	26	5	17	4	13	3	11	3	9	2	7	2	7	1.6	5	1.3	4
80				F	M	M	C	VC	XC	8	28	6	18	4	14	3	12	3	9	2	8	2	7	1.7	6	1.4	5
90				F	M	M	C	VC	XC	9	30	6	20	5	15	4	13	3	10	3	9	2	8	1.8	6	1.5	5
11003		20		M	VC	C	XC	UC	UC	UC	5	17	3	11	2	8	2	7	1.7	6	1.4	5	1.2	4	1.0	3	0.8
	30		F	M	C	C	VC	XC	UC	6	21	4	14	3	10	3	9	2	7	1.8	6	1.5	5	1.2	4	1.0	3
	40		F	M	M	M	VC	XC	UC	7	24	5	16	4	12	3	10	2	8	2	7	1.8	6	1.4	5	1.2	4
	50		F	M	M	M	VC	XC	UC	8	26	5	17	4	13	3	11	3	9	2	7	2	7	1.6	5	1.3	4
	60		F	M	M	M	VC	XC	UC	9	29	6	19	4	14	4	12	3	10	2	8	2	7	1.7	6	1.4	5
	70			F	M	M	C	VC	XC	9	31	6	21	5	15	4	13	3	10	3	9	2	8	1.9	6	1.5	5
	80			F	M	M	C	VC	XC	10	32	6	22	5	16	4	14	3	11	3	9	2	8	2	6	1.6	5
	90			F	M	M	C	VC	XC	10	35	7	23	5	17	4	15	3	12	3	10	3	9	2	7	1.7	6
	11004	20		M	VC	C	XC	UC	UC	UC	6	21	4	14	3	11	3	9	2	7	1.8	6	1.6	5	1.3	4	1.1
30			M	C	C	VC	XC	UC	UC	8	27	5	18	4	13	3	11	3	9	2	8	2	7	1.6	5	1.3	4
40			F	M	M	M	VC	XC	UC	9	31	6	21	5	15	4	13	3	10	3	9	2	8	1.9	6	1.5	5
50			F	M	M	M	VC	XC	UC	10	35	7	23	5	17	4	15	3	12	3	10	3	9	2	7	1.7	6
60			F	M	M	M	VC	XC	UC	11	38	8	25	6	19	5	16	4	13	3	11	3	10	2	8	2	6
70				F	M	M	C	VC	XC	12	41	8	27	6	21	5	17	4	14	4	12	3	10	2	8	2	7
80				F	M	M	C	VC	XC	13	44	9	29	7	22	5	18	4	15	4	12	3	11	3	9	2	7
90				F	M	M	C	VC	XC	14	46	9	31	7	23	6	19	5	15	4	13	3	11	3	9	2	8
11005		20		M	VC	C	XC	UC	UC	UC	8	27	5	18	4	13	3	11	3	9	2	8	2	7	1.6	5	1.3
	30		M	C	C	VC	XC	UC	UC	10	32	6	22	5	16	4	14	3	11	3	9	2	8	2	6	1.6	5
	40		M	M	C	C	VC	XC	UC	11	38	8	25	6	19	5	16	4	13	3	11	3	10	2	8	2	6
	50		M	M	M	M	VC	XC	UC	13	43	9	29	6	21	5	18	4	14	4	12	3	11	3	9	2	7
	60		M	M	M	M	VC	XC	UC	14	46	9	31	7	23	6	19	5	15	4	13	3	11	3	9	2	8
	70			F	M	M	C	VC	XC	15	50	10	33	7	25	6	21	5	17	4	14	4	12	3	10	2	8
	80			F	M	M	C	VC	XC	16	54	11	36	8	27	7	22	5	18	5	15	4	13	3	11	3	9
	90			F	M	M	C	VC	XC	17	57	11	38	9	29	7	24	6	19	5	16	4	14	3	11	3	10
	11006	20		M	VC	C	XC	UC	UC	UC	9	31	6	21	5	15	4	13	3	10	3	9	2	8	1.9	6	1.5
30			M	C	C	VC	XC	UC	UC	12	39	8	26	6	19	5	16	4	13	3	11	3	10	2	8	2	6
40			M	M	C	C	VC	XC	UC	13	44	9	30	7	22	6	18	4	15	4	13	3	11	3	9	2	7
50			M	M	M	M	VC	XC	UC	15	50	10	33	7	25	6	21	5	17	4	14	4	12	3	10	2	8
60			M	M	M	M	VC	XC	UC	16	54	11	36	8	27	7	22	5	18	5	15	4	13	3	11	3	9
70				F	M	M	C	VC	XC	18	59	12	39	9	29	7	24	6	20	5	17	4	15	4	12	3	10
80				F	M	M	C	VC	XC	19	63	13	42	9	31	8	26	6	21	5	18	5	16	4	13	3	10
90				F	M	M	C	VC	XC	20	67	13	44	10	33	8	28	7	22	6	19	5	17	4	13	3	11
11008		20		C	XC				UC	UC	12	40	8	26	6	20	5	17	4	13	3	11	3	10	2	8	2
	30		M	VC	C	XC	UC	UC	UC	14	48	10	32	7	24	6	20	5	16	4	14	4	12	3	10	2	8
	40		M	M	C	C	VC	XC	UC	17	55	11	37	8	28	7	23	6	18	5	16	4	14	3	11	3	9
	50		M	M	M</																						



# DYNAJET® PWM APPLICATION RATE CHARTS FOR SYSTEMS EQUIPPED WITH 115880 DYNAJET VALVES



20" TIP SPACING

SELECTION GUIDE

TIP SIZE	GAUGE PRESSURE (PSI)	30% MINIMUM DUTY CYCLE							SPEED RANGE (MPH)																		
		TJ60	XR/XRC	TT	TTJ60	AITJ60	TTI60	TTI	APTJ*	5 GPA		7.5 GPA		10 GPA		12 GPA		15 GPA		17.5 GPA		20 GPA		25 GPA		30 GPA	
										MIN	MAX	MIN	MAX	MIN	MAX	MIN	MAX	MIN	MAX	MIN	MAX	MIN	MAX	MIN	MAX	MIN	MAX
11001	20		F	C						1.2	4	0.8	3	0.6	2	0.5	1.7	0.4	1.4	0.4	1.2	0.3	1.0	0.2	0.8	0.2	0.7
	30		F	M						1.6	5	1.1	4	0.8	3	0.7	2	0.5	1.8	0.5	1.5	0.4	1.3	0.3	1.1	0.3	0.9
	40		F	M						1.8	6	1.2	4	0.9	3	0.7	2	0.6	2	0.5	1.7	0.4	1.5	0.4	1.2	0.3	1.0
	50		F	M						2	7	1.3	4	1.0	3	0.8	3	0.7	2	0.6	1.9	0.5	1.6	0.4	1.3	0.3	1.1
	60		VF	M						2	7	1.4	5	1.1	4	0.9	3	0.7	2	0.6	2	0.5	1.8	0.4	1.4	0.4	1.2
	70			F	M					2	8	1.5	5	1.2	4	1.0	3	0.8	3	0.7	2	0.6	2	0.5	1.5	0.4	1.3
	80			F	F					2	8	1.7	6	1.2	4	1.0	3	0.8	3	0.7	2	0.6	2	0.5	1.7	0.4	1.4
90			F	F					3	9	1.8	6	1.3	4	1.1	4	0.9	3	0.8	3	0.7	2	0.5	1.8	0.4	1.5	
110015	20		F	VC				UC	UC	2	7	1.3	4	1.0	3	0.8	3	0.7	2	0.6	1.9	0.5	1.6	0.4	1.3	0.3	1.1
	30		F	C				UC	UC	2	8	1.5	5	1.2	4	1.0	3	0.8	3	0.7	2	0.6	2	0.5	1.5	0.4	1.3
	40		F	M				UC	UC	3	9	1.8	6	1.3	4	1.1	4	0.9	3	0.8	3	0.7	2	0.5	1.8	0.4	1.5
	50		F	M				XC	UC	3	10	2	7	1.5	5	1.3	4	1.0	3	0.9	3	0.8	3	0.6	2	0.5	1.7
	60		F	M				XC	UC	3	11	2	7	1.6	5	1.3	4	1.1	4	0.9	3	0.8	3	0.6	2	0.5	1.8
	70			M	M			VC	XC	4	12	2	8	1.8	6	1.5	5	1.2	4	1.0	3	0.9	3	0.7	2	0.6	2
	80			F	F			VC	XC	4	12	2	8	1.9	6	1.6	5	1.2	4	1.1	4	0.9	3	0.7	2	0.6	2
90			F	F			VC	XC	4	14	3	9	2	7	1.7	6	1.4	5	1.2	4	1.0	3	0.8	3	0.7	2	
11002	20		M	VC	C	XC	UC	UC	UC	2	8	1.7	6	1.2	4	1.0	3	0.8	3	0.7	2	0.6	2	0.5	1.7	0.4	1.4
	30		F	C	C	VC	XC	UC	UC	3	10	2	7	1.5	5	1.3	4	1.0	3	0.9	3	0.8	3	0.6	2	0.5	1.7
	40		F	M	M	VC	XC	UC	UC	4	12	2	8	1.8	6	1.5	5	1.2	4	1.0	3	0.9	3	0.7	2	0.6	2
	50		F	M	M	VC	XC	UC	UC	4	13	3	9	2	7	1.6	5	1.3	4	1.1	4	1.0	3	0.8	3	0.7	2
	60		F	M	M	C	VC	XC	UC	4	14	3	10	2	7	1.8	6	1.4	5	1.2	4	1.1	4	0.9	3	0.7	2
	70			M	M	C	VC	XC	UC	5	15	3	10	2	8	2	6	1.5	5	1.3	4	1.2	4	0.9	3	0.8	3
	80			F	M	C	VC	XC	UC	5	17	3	11	2	8	2	7	1.7	6	1.4	5	1.2	4	1.0	3	0.8	3
90			F	M	C	VC	XC	UC	5	18	4	12	3	9	2	7	1.8	6	1.5	5	1.3	4	1.1	4	0.9	3	
11025	20		M	VC	C	XC	UC	UC	UC	3	11	2	7	1.6	5	1.3	4	1.1	4	0.9	3	0.8	3	0.6	2	0.5	1.8
	30		M	C	C	VC	XC	UC	UC	4	13	3	9	2	7	1.6	5	1.3	4	1.1	4	1.0	3	0.8	3	0.7	2
	40		F	M	M	VC	XC	UC	UC	4	15	3	10	2	7	1.9	6	1.5	5	1.3	4	1.1	4	0.9	3	0.7	2
	50		F	M	M	VC	XC	UC	UC	5	17	3	11	2	8	2	7	1.7	6	1.4	5	1.2	4	1.0	3	0.8	3
	60		F	M	M	C	VC	XC	UC	6	18	4	12	3	9	2	8	1.8	6	1.6	5	1.4	5	1.1	4	0.9	3
	70			M	M	C	VC	XC	UC	6	20	4	13	3	10	2	8	2	7	1.7	6	1.5	5	1.2	4	1.0	3
	80			F	M	C	VC	XC	UC	6	21	4	14	3	10	3	9	2	7	1.8	6	1.6	5	1.2	4	1.0	3
90			F	M	C	VC	XC	UC	7	23	5	15	3	11	3	9	2	8	2	6	1.7	6	1.4	5	1.1	4	
11003	20		M	VC	C	XC	UC	UC	UC	4	12	2	8	1.9	6	1.6	5	1.2	4	1.1	4	0.9	3	0.7	2	0.6	2
	30		F	C	C	VC	XC	UC	UC	5	15	3	10	2	8	2	6	1.5	5	1.3	4	1.2	4	0.9	3	0.8	3
	40		F	M	M	VC	XC	UC	UC	5	18	4	12	3	9	2	7	1.8	6	1.5	5	1.3	4	1.1	4	0.9	3
	50		F	M	M	VC	XC	UC	UC	6	20	4	13	3	10	2	8	2	7	1.7	6	1.5	5	1.2	4	1.0	3
	60		F	M	M	C	VC	XC	UC	6	21	4	14	3	11	3	9	2	7	1.8	6	1.6	5	1.3	4	1.1	4
	70			M	M	C	VC	XC	UC	7	23	5	15	3	12	3	10	2	8	2	7	1.7	6	1.4	5	1.2	4
	80			F	M	C	VC	XC	UC	7	24	5	16	4	12	3	10	2	8	2	7	1.8	6	1.5	5	1.2	4
90			F	M	C	VC	XC	UC	8	26	5	17	4	13	3	11	3	9	2	7	1.8	6	1.6	5	1.3	4	
11004	20		M	VC	C	XC	UC	UC	UC	5	16	3	11	2	8	2	7	1.6	5	1.4	5	1.2	4	1.0	3	0.8	3
	30		M	C	C	VC	XC	UC	UC	6	20	4	13	3	10	3	8	2	7	1.7	6	1.5	5	1.2	4	1.0	3
	40		F	M	M	VC	XC	UC	UC	7	23	5	15	3	12	3	10	2	8	2	7	1.7	6	1.4	5	1.2	4
	50		F	M	M	VC	XC	UC	UC	8	26	5	17	4	13	3	11	3	9	2	7	1.7	6	1.6	5	1.3	4
	60		F	M	M	C	VC	XC	UC	9	29	6	19	4	14	4	12	3	10	2	8	2	7	1.7	6	1.4	5
	70			M	M	C	VC	XC	UC	9	31	6	21	5	15	4	13	3	10	3	9	2	8	1.9	6	1.5	5
	80			F	M	C	VC	XC	UC	10	33	7	22	5	16	4	14	3	11	3	9	2	8	2	7	1.6	5
90			F	M	C	VC	XC	UC	10	34	7	23	5	17	4	14	3	11	3	10	3	9	2	7	1.7	6	
11005	20		M	VC	C	XC	UC	UC	UC	6	20	4	13	3	10	3	8	2	7	1.7	6	1.5	5	1.2	4	1.0	3
	30		M	C	C	VC	XC	UC	UC	7	24	5	16	4	12	3	10	2	8	2	7	1.8	6	1.5	5	1.2	4
	40		M	M	C	C	VC	XC	UC	9	29	6	19	4	14	4	12	3	10	2	8	2	7	1.7	6	1.4	5
	50		M	M	C	C	VC	XC	UC	10	32	6	21	5	16	4	13	3	11	3	9	2	8	2	6	1.6	5
	60		M	M	C	C	VC	XC	UC	10	34	7	23	5	17	4	14	3	11	3	10	3	9	2	7	1.7	6
	70			M	M	C	VC	XC	UC	11	37	7	25	6	19	5	16	4	12	3	11	3	9	2	7	1.9	6
	80			M	M	C	VC	XC	UC	12	40	8	27	6	20	5	17	4	13	3	12	3	10	2	8	2	7
90			F	M	C	VC	XC	UC	13	43	9	29	6	21	5	18	4	14	4	12	3	11	3	9	2	7	
11006	20		M	VC	C	XC	UC	UC	UC	7	23	5	15	3	12	3	10	2	8	2	7	1.7	6	1.4	5	1.2	4
	30		M	C	C	VC	XC	UC	UC	9	29	6	19	4	15	4	12	3	10	2	8	2	7	1.7	6	1.5	5
	40		M	M	C	C	VC	XC	UC	10	33	7	22	5	17	4	14	3	11	3	10	2	8	2	7	1.7	6
	50		M	M	C	C	VC	XC	UC	11	37	7	25	6	19	5	16	4	12	3	11	3	9	2	7	1.9	6
	60		M	M	C	C	VC	XC	UC	12	40	8	27	6	20	5	17	4	13	3	12	3	10	2	8	2	7
	70			M	M	C	VC	XC	UC	13	44	9	29	7	22	5	18	4	15	4	13	3	11	3	9	2	7
	80			M	M	C	VC	XC	UC	14	47	9	31	7	23	6	20	5	16	4	13	4	12	3	9	2	8
90			F	M	C	VC	XC	UC	15	50	10	33	7	25	6	21	5	17	4	14	4	12	3	10	2	8	
11008	20		C	XC				UC	UC	9	30	6	20	4	15	4	12	3	10	3	8	2	7	1.8	6	1.5	5
	30		M	VC	C	XC	UC	UC	UC	11	36	7	24	5	18	5	15	4	12	3	10	3	9	2	7	1.8	6
	40		M	VC	C	XC	UC	UC	UC																		





## Typical Applications



**HERBICIDE**  
SOIL APPLIED  
**EXCELLENT**  
SYSTEMIC  
**EXCELLENT**



**FERTILIZER**  
BROADCAST  
**EXCELLENT**



**DRIFT CONTROL**  
**EXCELLENT**



**PWM APPROVED**



## FEATURES

- Specifically designed for use on sprayers equipped with Pulse Width Modulation (PWM) spray tip control.
- Can also be used for non-PWM applications, where maximum drift control is desired.
- Non-air induction Twin spray tip, that produces highly drift-resistant droplets (XC and UC).
- Patent-pending recirculating design and concave exit orifice geometry provide optimal spray performance.
- Twin spray pattern allows for improved coverage and canopy penetration.
- Compact design fits into tight boom spaces and is less likely to be damaged during field use.
- Available in ten VisiFlo® Polymer (VP) capacities.
- Optimal for burndown, pre-emerge, and post-emerge systemic applications.
- Automatic spray alignment with Quick TeeJet® cap and gasket 114441A-\*CELR (01 to 08) or 114502A-\*CELR (10 and 12). Reference page 118 for more information.

### SPRAY PATTERN



### DROPLET SIZE CLASSIFICATION

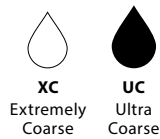

### OPTIMUM SPRAY HEIGHT

 <b>ANGLE</b>	 <b>HEIGHT</b>
110°	20"

### RECOMMENDED PRESSURE RANGE



### MATERIALS AVAILABLE



## HOW TO ORDER

Polymer with VisiFlo color-coding

**A P T J - 1 1 0 0 4 V P**

Tip Type    Spray Angle    Capacity Size    Material Code

Polymer with VisiFlo color-coding, includes Quick TeeJet® cap and gasket\*

**A P T J - 1 1 0 0 4 V P - C E**

Tip Type    Spray Angle    Capacity Size    Material Code    Cap and Gasket Included

\*Reference page 118 for more caps information.

# AccuPulse® TwinJet® TWIN FLAT SPRAY



BROADCAST NOZZLES

TIP PART NO. (STRAINER MESH SIZE)	PSI	DROP SIZE	CAPACITY ONE TIP IN GPM	CAPACITY ONE TIP IN OZ/MIN	APPLICATION RATE FOR 20" SPRAY TIP SPACING															
					GALLONS PER ACRE (GPA)										TURF APPLICATION GALLONS PER 1000 SQ. FT.					
					4 MPH	5 MPH	6 MPH	8 MPH	10 MPH	12 MPH	14 MPH	16 MPH	20 MPH	2 MPH	3 MPH	4 MPH	5 MPH			
APTJ-110015VP (100)	20	UC	0.115	15	8.5	6.8	5.7	4.3	3.4	2.8	2.4	2.1	1.7	0.39	0.26	0.20	0.16			
	30	UC	0.134	17	9.9	8.0	6.6	5.0	4.0	3.3	2.8	2.5	2.0	0.46	0.30	0.23	0.18			
	40	UC	0.150	19	11.1	8.9	7.4	5.6	4.5	3.7	3.2	2.8	2.2	0.51	0.34	0.26	0.20			
	50	UC	0.163	21	12.1	9.7	8.1	6.1	4.8	4.0	3.5	3.0	2.4	0.55	0.37	0.28	0.22			
	60	XC	0.175	22	13.0	10.4	8.7	6.5	5.2	4.3	3.7	3.2	2.6	0.60	0.40	0.30	0.24			
	70	XC	0.185	24	13.7	11.0	9.2	6.9	5.5	4.6	3.9	3.4	2.7	0.63	0.42	0.31	0.25			
	80	XC	0.195	25	14.5	11.6	9.7	7.2	5.8	4.8	4.1	3.6	2.9	0.66	0.44	0.33	0.27			
90	XC	0.204	26	15.1	12.1	10.1	7.6	6.1	5.0	4.3	3.8	3.0	0.7	0.46	0.35	0.28				
100	XC	0.212	27	15.7	12.6	10.5	7.9	6.3	5.2	4.5	3.9	3.1	0.7	0.48	0.36	0.29				
APTJ-11002VP (100)	20	UC	0.15	19	11.1	8.9	7.4	5.6	4.5	3.7	3.2	2.8	2.2	0.51	0.34	0.26	0.20			
	30	UC	0.18	23	13.4	10.7	8.9	6.7	5.3	4.5	3.8	3.3	2.7	0.61	0.41	0.31	0.24			
	40	UC	0.20	26	14.9	11.9	9.9	7.4	5.9	5.0	4.2	3.7	3.0	0.68	0.45	0.34	0.27			
	50	UC	0.22	28	16.3	13.1	10.9	8.2	6.5	5.4	4.7	4.1	3.3	0.75	0.50	0.37	0.30			
	60	UC	0.23	29	17.1	13.7	11.4	8.5	6.8	5.7	4.9	4.3	3.4	0.78	0.52	0.39	0.31			
	70	XC	0.25	32	18.6	14.9	12.4	9.3	7.4	6.2	5.3	4.6	3.7	0.85	0.57	0.43	0.34			
	80	XC	0.26	33	19.3	15.4	12.9	9.7	7.7	6.4	5.5	4.8	3.9	0.88	0.59	0.44	0.35			
90	XC	0.27	35	20	16.0	13.4	10.0	8.0	6.7	5.7	5.0	4.0	0.9	0.61	0.46	0.37				
100	XC	0.28	36	21	16.6	13.9	10.4	8.3	6.9	5.9	5.2	4.2	1.0	0.63	0.48	0.38				
APTJ-110025VP (100)	20	UC	0.19	24	14.1	11.3	9.4	7.1	5.6	4.7	4.0	3.5	2.8	0.65	0.43	0.32	0.26			
	30	UC	0.22	28	16.3	13.1	10.9	8.2	6.5	5.4	4.7	4.1	3.3	0.75	0.50	0.37	0.30			
	40	UC	0.25	32	18.6	14.9	12.4	9.3	7.4	6.2	5.3	4.6	3.7	0.85	0.57	0.43	0.34			
	50	UC	0.27	35	20	16.0	13.4	10.0	8.0	6.7	5.7	5.0	4.0	0.92	0.61	0.46	0.37			
	60	UC	0.29	37	22	17.2	14.4	10.8	8.6	7.2	6.2	5.4	4.3	1.0	0.66	0.49	0.39			
	70	XC	0.31	40	23	18.4	15.3	11.5	9.2	7.7	6.6	5.8	4.6	1.1	0.70	0.53	0.42			
	80	XC	0.33	42	25	19.6	16.3	12.3	9.8	8.2	7.0	6.1	4.9	1.1	0.75	0.56	0.45			
90	XC	0.34	44	25	20	16.8	12.6	10.1	8.4	7.2	6.3	5.0	1.2	0.77	0.58	0.46				
100	XC	0.35	45	26	21	17.3	13.0	10.4	8.7	7.4	6.5	5.2	1.2	0.79	0.60	0.48				
APTJ-11003VP (50)	20	UC	0.23	29	17.1	13.7	11.4	8.5	6.8	5.7	4.9	4.3	3.4	0.78	0.52	0.39	0.31			
	30	UC	0.27	35	20	16.0	13.4	10.0	8.0	6.7	5.7	5.0	4.0	0.92	0.61	0.46	0.37			
	40	UC	0.30	38	22	17.8	14.9	11.1	8.9	7.4	6.4	5.6	4.5	1.0	0.68	0.51	0.41			
	50	UC	0.33	42	25	19.6	16.3	12.3	9.8	8.2	7.0	6.1	4.9	1.1	0.75	0.56	0.45			
	60	UC	0.35	45	26	21	17.3	13.0	10.4	8.7	7.4	6.5	5.2	1.2	0.79	0.60	0.48			
	70	XC	0.37	47	27	22	18.3	13.7	11.0	9.2	7.8	6.9	5.5	1.3	0.84	0.63	0.50			
	80	XC	0.39	50	29	23	19.3	14.5	11.6	9.7	8.3	7.2	5.8	1.3	0.88	0.66	0.53			
90	XC	0.41	52	30	24	20	15.2	12.2	10.1	8.7	7.6	6.1	1.4	0.9	0.70	0.56				
100	XC	0.42	54	31	25	21	15.6	12.5	10.4	8.9	7.8	6.2	1.4	1.0	0.71	0.57				
APTJ-11004VP (50)	20	UC	0.31	40	23	18.4	15.3	11.5	9.2	7.7	6.6	5.8	4.6	1.05	0.70	0.53	0.42			
	30	UC	0.36	46	27	21	17.8	13.4	10.7	8.9	7.6	6.7	5.3	1.2	0.82	0.61	0.49			
	40	UC	0.40	51	30	24	19.8	14.9	11.9	9.9	8.5	7.4	5.9	1.4	0.91	0.68	0.54			
	50	UC	0.43	55	32	26	21	16.0	12.8	10.6	9.1	8.0	6.4	1.5	1.0	0.73	0.58			
	60	UC	0.47	60	35	28	23	17.4	14.0	11.6	10.0	8.7	7.0	1.6	1.1	0.80	0.64			
	70	XC	0.49	63	36	29	24	18.2	14.6	12.1	10.4	9.1	7.3	1.7	1.1	0.83	0.67			
	80	XC	0.52	67	39	31	26	19.3	15.4	12.9	11.0	9.7	7.7	1.8	1.2	0.88	0.71			
90	XC	0.54	69	40	32	27	20	16.0	13.4	11.5	10.0	8.0	1.8	1.2	0.9	0.73				
100	XC	0.56	72	42	33	28	21	16.6	13.9	11.9	10.4	8.3	1.9	1.3	1.0	0.76				
APTJ-11005VP (50)	20	UC	0.38	49	28	23	18.8	14.1	11.3	9.4	8.1	7.1	5.6	1.3	0.86	0.65	0.52			
	30	UC	0.45	58	33	27	22	16.7	13.4	11.1	9.5	8.4	6.7	1.5	1.02	0.77	0.61			
	40	UC	0.50	64	37	30	25	18.6	14.9	12.4	10.6	9.3	7.4	1.7	1.1	0.85	0.68			
	50	UC	0.55	70	41	33	27	20	16.3	13.6	11.7	10.2	8.2	1.9	1.2	0.94	0.75			
	60	UC	0.59	76	44	35	29	22	17.5	14.6	12.5	11.0	8.8	2.0	1.3	1.0	0.80			
	70	XC	0.63	81	47	37	31	23	18.7	15.6	13.4	11.7	9.4	2.1	1.4	1.1	0.86			
	80	XC	0.66	84	49	39	33	25	19.6	16.3	14.0	12.3	9.8	2.2	1.5	1.1	0.90			
90	XC	0.69	88	51	41	34	26	20	17.1	14.6	12.8	10.2	2.3	1.6	1.2	0.9				
100	XC	0.72	92	53	43	36	27	21	17.8	15.3	13.4	10.7	2.4	1.6	1.2	1.0				
APTJ-11006VP (50)	20	UC	0.45	58	33	27	22	16.7	13.4	11.1	9.5	8.4	6.7	1.5	1.02	0.77	0.61			
	30	UC	0.53	68	39	31	26	19.7	15.7	13.1	11.2	9.8	7.9	1.8	1.2	0.90	0.72			
	40	UC	0.60	77	45	36	30	22	17.8	14.9	12.7	11.1	8.9	2.0	1.4	1.0	0.82			
	50	UC	0.66	84	49	39	33	25	19.6	16.3	14.0	12.3	9.8	2.2	1.5	1.1	0.90			
	60	UC	0.71	91	53	42	35	26	21	17.6	15.1	13.2	10.5	2.4	1.6	1.2	0.97			
	70	XC	0.76	97	56	45	38	28	23	18.8	16.1	14.1	11.3	2.6	1.7	1.3	1.0			
	80	XC	0.80	102	59	48	40	30	24	19.8	17.0	14.9	11.9	2.7	1.8	1.4	1.1			
90	XC	0.84	108	62	50	42	31	25	21	17.8	15.6	12.5	2.9	1.9	1.4	1.1				
100	XC	0.88	113	65	52	44	33	26	22	18.7	16.3	13.1	3.0	2.0	1.5	1.2				
APTJ-11008VP (50)	20	UC	0.60	77	45	36	30	22	17.8	14.9	12.7	11.1	8.9	2.0	1.4	1.02	0.82			
	30	UC	0.71	91	53	42	35	26	21	17.6	15.1	13.2	10.5	2.4	1.6	1.2	0.97			
	40	UC	0.80	102	59	48	40	30	24	19.8	17.0	14.9	11.9	2.7	1.8	1.4	1.1			
	50	UC	0.88	113	65	52	44	33	26	22	18.7	16.3	13.1	3.0	2.0	1.5	1.2			
	60	UC	0.95	122	71	56	47	35	28	24	20	17.6	14.1	3.2	2.2	1.6	1.3			
	70	XC	1.02	131	76	61	50	38	30	25	22	18.9	15.1	3.5	2.3	1.7	1.4			
	80	XC	1.08	138	80	64	53	40	32	27	23	20	16.0	3.7	2.4	1.8	1.5			
90	XC	1.13	145	84	67	56	42	34	28	24	21	16.8	3.8	2.6	1.9	1.5				
100	XC	1.18	151	88	70	58	44	35	29	25	22	17.5	4.0	2.7	2.0	1.6				
APTJ-11010VP (50)	20	UC	0.74	95	55	44	37	27	22	18.3	15.7	13.7	11.0	2.5	1.7	1.3	1.01			
	30	UC	0.88	113	65	52	44	33	26	22	18.7	16.3	13.1	3.0	2.0	1.5	1.2			
	40	UC	1.00	128	74	59	50	37	30	25	21	18.6	14.9	3.4	2.3	1.7	1.4			
	50	UC	1.10	141	82	65	54	41	33	27	23	20	16.3	3.7	2.5	1.9	1.5			
	60	UC	1.19	152	88	71	59	44	35	29	25	22	17.7	4.0	2.7	2.0	1.6			
	70	XC	1.28	164	95	76	63	48	38	32	27	24	19.0	4.4	2.9	2.2	1.7			
	80	XC	1.35	173	100	80	67	50	40	33	29	25	20	4.6	3.1	2.3	1.8			
90	XC	1.43	183	106	85	71	53	42	35	30	27	21	4.9	3.2	2.4	1.9				
100	XC	1.49	191	111	89	74	55	44	37	32	28	22	5.1	3.4	2.5	2.0				
APTJ-11012VP (50)	20	UC	0.90	115	67	53	45	33	27	22	19.1	16.7	13.4	3.1	2.0	1.53	1.22			
	30	UC	1.06	136	79	63	52	39	31	26	22	19.7	15.7	3.6	2.4	1.8	1.44			
	40	UC	1.20	154	89	71	59	45	36	30	2									





BROADCAST NOZZLES

## Typical Applications



**HERBICIDE**  
CONTACT  
**EXCELLENT**  
SYSTEMIC  
**VERY GOOD**



**FUNGICIDE**  
CONTACT  
**EXCELLENT**  
SYSTEMIC  
**VERY GOOD**



**INSECTICIDE**  
CONTACT  
**EXCELLENT**  
SYSTEMIC  
**VERY GOOD**



**FERTILIZER**  
BROADCAST  
**EXCELLENT**



**DRIFT CONTROL**  
**GOOD**



**PWM APPROVED**



## FEATURES

- Tapered edge wide angle flat spray pattern for uniform coverage in broadcast spraying.
- 15° attack angle for better canopy penetration.
- Available in polymer and ceramic for more flexibility on the choice according to different pesticide formulation.
- Large, rounded internal passage to minimize clogging.
- Polymer material used on the TT-VP provides a good wear life and acid resistance.
- The TT-VK polypropylene body provides excellent acid resistance and the ceramic pre- and exit orifice offers improved wear life.
- Unique internal configuration means substantially longer wear life.
- Available in eleven VisiFlo® Polymer (VP) and nine VisiFlo ceramic (VK) capacities.
- Automatic spray alignment with Quick TeeJet® cap and gasket 114441A-\*CELR (01 to 08) or 114502A-\*CELR (10 and 12). Reference page 118 for more information.

## SPRAY PATTERN

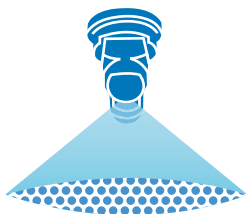

## DROPLET SIZE CLASSIFICATION

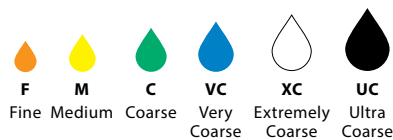

## OPTIMUM SPRAY HEIGHT

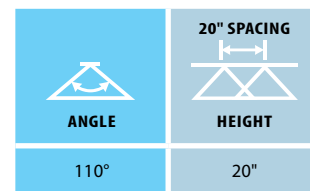

## RECOMMENDED PRESSURE RANGE



## MATERIALS AVAILABLE



## HOW TO ORDER

Polymer with VisiFlo color-coding

**TT 1 1 0 0 1 - V P**

Tip Type	Spray Angle	Capacity Size	Material Code
----------	-------------	---------------	---------------

Polymer with VisiFlo color-coding, includes Quick TeeJet cap and gasket\*

**TT 1 1 0 0 2 - V P - C E**

Tip Type	Spray Angle	Capacity Size	Material Code	Cap and Gasket Included
----------	-------------	---------------	---------------	-------------------------

\*Reference page 118 for more caps information.



BROADCAST NOZZLES

TIP PART NO. (STRAINER MESH SIZE)	PSI	DROP SIZE	CAPACITY ONE TIP IN GPM	CAPACITY ONE TIP IN OZ/MIN	APPLICATION RATE FOR 20" SPRAY TIP SPACING															
					GALLONS PER ACRE (GPA)								TURF APPLICATION GALLONS PER 1000 SQ. FT.							
					4 MPH	5 MPH	6 MPH	8 MPH	10 MPH	12 MPH	15 MPH	20 MPH	2 MPH	3 MPH	4 MPH	5 MPH				
TT11001 (100)	15	VC	0.061	7.8	4.5	3.6	3.0	2.3	1.8	1.5	1.2	0.91	0.21	0.14	0.10	0.08				
	20	C	0.071	9.1	5.3	4.2	3.5	2.6	2.1	1.8	1.4	1.1	0.24	0.16	0.12	0.10				
	30	M	0.087	11	6.5	5.2	4.3	3.2	2.6	2.2	1.7	1.3	0.30	0.20	0.15	0.12				
	40	M	0.10	13	7.4	5.9	5.0	3.7	3.0	2.5	2.0	1.5	0.34	0.23	0.17	0.14				
	50	M	0.11	14	8.2	6.5	5.4	4.1	3.3	2.7	2.2	1.6	0.37	0.25	0.19	0.15				
	60	M	0.12	15	8.9	7.1	5.9	4.5	3.6	3.0	2.4	1.8	0.41	0.27	0.20	0.16				
	75	F	0.14	18	10.4	8.3	6.9	5.2	4.2	3.5	2.8	2.1	0.48	0.32	0.24	0.19				
90	F	0.15	19	11.1	8.9	7.4	5.6	4.5	3.7	3.0	2.2	0.51	0.34	0.26	0.20					
TT110015 (100)	15	VC	0.092	12	6.8	5.5	4.6	3.4	2.7	2.3	1.8	1.4	0.31	0.21	0.16	0.13				
	20	VC	0.11	14	8.2	6.5	5.4	4.1	3.3	2.7	2.2	1.6	0.37	0.25	0.19	0.15				
	30	C	0.13	17	9.7	7.7	6.4	4.8	3.9	3.2	2.6	1.9	0.44	0.29	0.22	0.18				
	40	M	0.15	19	11.1	8.9	7.4	5.6	4.5	3.7	3.0	2.2	0.51	0.34	0.26	0.20				
	50	M	0.17	22	12.6	10.1	8.4	6.3	5.0	4.2	3.4	2.5	0.58	0.39	0.29	0.23				
	60	M	0.18	23	13.4	10.7	8.9	6.7	5.3	4.5	3.6	2.7	0.61	0.41	0.31	0.24				
	75	M	0.21	27	15.6	12.5	10.4	7.8	6.2	5.2	4.2	3.1	0.71	0.48	0.36	0.29				
90	F	0.23	29	17.1	13.7	11.4	8.5	6.8	5.7	4.6	3.4	0.78	0.52	0.39	0.31					
TT11002 (50)	15	VC	0.12	15	8.9	7.1	5.9	4.5	3.6	3.0	2.4	1.8	0.41	0.27	0.20	0.16				
	20	VC	0.14	18	10.4	8.3	6.9	5.2	4.2	3.5	2.8	2.1	0.48	0.32	0.24	0.19				
	30	C	0.17	22	12.6	10.1	8.4	6.3	5.0	4.2	3.4	2.5	0.58	0.39	0.29	0.23				
	40	M	0.20	26	14.9	11.9	9.9	7.4	5.9	5.0	4.0	3.0	0.68	0.45	0.34	0.27				
	50	M	0.22	28	16.3	13.1	10.9	8.2	6.5	5.4	4.4	3.3	0.75	0.50	0.37	0.30				
	60	M	0.24	31	17.8	14.3	11.9	8.9	7.1	5.9	4.8	3.6	0.82	0.54	0.41	0.33				
	75	M	0.27	35	20	16.0	13.4	10.0	8.0	6.7	5.3	4.0	0.92	0.61	0.46	0.37				
90	F	0.30	38	22	17.8	14.9	11.1	8.9	7.4	5.9	4.5	1.0	0.68	0.51	0.41					
TT110025 (50)	15	VC	0.15	19	11.1	8.9	7.4	5.6	4.5	3.7	3.0	2.2	0.51	0.34	0.26	0.20				
	20	VC	0.18	23	13.4	10.7	8.9	6.7	5.3	4.5	3.6	2.7	0.61	0.41	0.31	0.24				
	30	C	0.22	28	16.3	13.1	10.9	8.2	6.5	5.4	4.4	3.3	0.75	0.50	0.37	0.30				
	40	M	0.25	32	18.6	14.9	12.4	9.3	7.4	6.2	5.0	3.7	0.85	0.57	0.43	0.34				
	50	M	0.28	36	21	16.6	13.9	10.4	8.3	6.9	5.5	4.2	0.95	0.63	0.48	0.38				
	60	M	0.31	40	23	18.4	15.3	11.5	9.2	7.7	6.1	4.6	1.1	0.70	0.53	0.42				
	75	M	0.34	44	25	20	16.8	12.6	10.1	8.4	6.7	5.0	1.2	0.77	0.58	0.46				
90	F	0.38	49	28	23	18.8	14.1	11.3	9.4	7.5	5.6	1.3	0.86	0.65	0.52					
TT11003 (50)	15	XC	0.18	23	13.4	10.7	8.9	6.7	5.3	4.5	3.6	2.7	0.61	0.41	0.31	0.24				
	20	VC	0.21	27	15.6	12.5	10.4	7.8	6.2	5.2	4.2	3.1	0.71	0.48	0.36	0.29				
	30	C	0.26	33	19.3	15.4	12.9	9.7	7.7	6.4	5.1	3.9	0.88	0.59	0.44	0.35				
	40	M	0.30	38	22	17.8	14.9	11.1	8.9	7.4	5.9	4.5	1.0	0.68	0.51	0.41				
	50	M	0.34	44	25	20	16.8	12.6	10.1	8.4	6.7	5.0	1.2	0.77	0.58	0.46				
	60	M	0.37	47	27	22	18.3	13.7	11.0	9.2	7.3	5.5	1.3	0.84	0.63	0.50				
	75	M	0.41	52	30	24	20	15.2	12.2	10.1	8.1	6.1	1.4	0.93	0.70	0.56				
90	F	0.45	58	33	27	22	16.7	13.4	11.1	8.9	6.7	1.5	1.0	0.77	0.61					
TT11004 (50)	15	XC	0.24	31	17.8	14.3	11.9	8.9	7.1	5.9	4.8	3.6	0.82	0.54	0.41	0.33				
	20	VC	0.28	36	21	16.6	13.9	10.4	8.3	6.9	5.5	4.2	0.95	0.63	0.48	0.38				
	30	C	0.35	45	26	21	17.3	13.0	10.4	8.7	6.9	5.2	1.2	0.79	0.60	0.48				
	40	M	0.40	51	30	24	19.8	14.9	11.9	9.9	7.9	5.9	1.4	0.91	0.68	0.54				
	50	M	0.45	58	33	27	22	16.7	13.4	11.1	8.9	6.7	1.5	1.0	0.77	0.61				
	60	M	0.49	63	36	29	24	18.2	14.6	12.1	9.7	7.3	1.7	1.1	0.83	0.67				
	75	M	0.55	70	41	33	27	20	16.3	13.6	10.9	8.2	1.9	1.2	0.94	0.75				
90	F	0.60	77	45	36	30	22	17.8	14.9	11.9	8.9	2.0	1.4	1.0	0.82					
TT11005 (50)	15	XC	0.31	40	23	18.4	15.3	11.5	9.2	7.7	6.1	4.6	1.1	0.70	0.53	0.42				
	20	VC	0.35	45	26	21	17.3	13.0	10.4	8.7	6.9	5.2	1.2	0.79	0.60	0.48				
	30	C	0.43	55	32	26	21	16.0	12.8	10.6	8.5	6.4	1.5	0.97	0.73	0.58				
	40	M	0.50	64	37	30	25	18.6	14.9	12.4	9.9	7.4	1.7	1.1	0.85	0.68				
	50	M	0.56	72	42	33	28	21	16.6	13.9	11.1	8.3	1.9	1.3	0.95	0.76				
	60	M	0.61	78	45	36	30	23	18.1	15.1	12.1	9.1	2.1	1.4	1.0	0.83				
	75	M	0.68	87	50	40	34	25	20	16.8	13.5	10.1	2.3	1.5	1.2	0.92				
90	F	0.75	96	56	45	37	28	22	18.6	14.9	11.1	2.6	1.7	1.3	1.0					
TT11006 (50)	15	XC	0.37	47	27	22	18.3	13.7	11.0	9.2	7.3	5.5	1.3	0.84	0.63	0.50				
	20	VC	0.42	54	31	25	21	15.6	12.5	10.4	8.3	6.2	1.4	0.95	0.71	0.57				
	30	C	0.52	67	39	31	26	19.3	15.4	12.9	10.3	7.7	1.8	1.2	0.88	0.71				
	40	M	0.60	77	45	36	30	22	17.8	14.9	11.9	8.9	2.0	1.4	1.0	0.82				
	50	M	0.67	86	50	40	33	25	19.9	16.6	13.3	9.9	2.3	1.5	1.1	0.91				
	60	M	0.73	93	54	43	36	27	22	18.1	14.5	10.8	2.5	1.7	1.2	0.99				
	75	M	0.82	105	61	49	41	30	24	20	16.2	12.2	2.8	1.9	1.4	1.1				
90	F	0.90	115	67	53	45	33	27	22	17.8	13.4	3.1	2.0	1.5	1.2					
TT11008 (50)	15	XC	0.49	63	36	29	24	18.2	14.6	12.1	9.7	7.3	1.7	1.1	0.83	0.67				
	20	VC	0.57	73	42	34	28	21	16.9	14.1	11.3	8.5	1.9	1.3	0.97	0.78				
	30	VC	0.69	88	51	41	34	26	20	17.1	13.7	10.2	2.3	1.6	1.2	0.94				
	40	M	0.80	102	59	48	40	30	24	19.8	15.8	11.9	2.7	1.8	1.4	1.1				
	50	M	0.89	114	66	53	44	33	26	22	17.6	13.2	3.0	2.0	1.5	1.2				
	60	M	0.98	125	73	58	49	36	29	24	19.4	14.6	3.3	2.2	1.7	1.3				
	75	M	1.10	141	82	65	54	41	33	27	22	16.3	3.7	2.5	1.9	1.5				
90	F	1.20	154	89	71	59	45	36	30	24	17.8	4.1	2.7	2.0	1.6					
TT11010	15	XC	0.61	78	45	36	30	23	18.1	15.1	12.1	9.1	2.1	1.4	1.0	0.83				
	20	XC	0.71	91	53	42	35	26	21	17.6	14.1	10.5	2.4	1.6	1.2	0.97				
	30	VC	0.87	111	65	52	43	32	26	22	17.2	12.9	3.0	2.0	1.5	1.2				
	40	VC	1.00	128	74	59	50	37	30	25	19.8	14.9	3.4	2.3	1.7	1.4				
	50	C	1.12	143	83	67	55	42	33	28	22	16.6	3.8	2.5	1.9	1.5				
	60	C	1.22	156	91	72	60	45	36	30	24	18.1	4.2	2.8	2.1	1.7				
	75	C	1.37	175	102	81	68	51	41	34	27	20	4.6	3.1	2.3	1.87				
90	M	1.50	192	111	89	74	56	45	37	30	22	5.1	3.4	2.6	2.0					
TT11012	15	XC	0.73	93	54	43	36	27	22	18.1	14.5	10.8	2.5	1.7	1.2	0.99				
	20	XC	0.85	109	63	50	42	32	25	21	16.8	12.6	2.9	1.9	1.5	1.2				
	30	XC	1.04	133	77	62	51	39	31	26	21	15.4	3.5	2.4	1.8	1.4				
	40	VC	1.20	154	89	71	59	45	36	30	24	17.8	4.1	2.7	2.0	1.6				
	50	VC	1.34	172	99	80	66	50	40	33	27	19.9	4.6	3.0	2.3	1.8				
	60	VC	1.47	188	109	87	73	55	44	36	29	22	5.0	3.3	2.5	2.0				
	75	C	1.64	210	122	97	81	61	49	41	32	24	5.6	3.7	2.8	2.2				



## Typical Applications



**HERBICIDE**  
SOIL APPLIED  
**VERY GOOD**  
CONTACT  
**EXCELLENT**  
SYSTEMIC  
**VERY GOOD**



**FUNGICIDE**  
CONTACT  
**GOOD**  
SYSTEMIC  
**VERY GOOD**



**INSECTICIDE**  
CONTACT  
**VERY GOOD**  
SYSTEMIC  
**EXCELLENT**



**DRIFT CONTROL**  
**VERY GOOD**



## FEATURES

- Tapered edge flat spray angle pattern with air induction technology offers better drift management.
- Produces large air-filled droplets through a Venturi air aspirator.
- Unique UHMWPE polymer material used on the AIXR-VP adds improved wear life and better acid resistance.
- The AIXR-VK polypropylene body provides excellent acid resistance, and the ceramic pre- and exit orifice offers improved wear life.
- Compact size to prevent tip damage.
- Removable pre-orifice.
- Available in nine VisiFlo® Polymer (VP) and seven VisiFlo ceramic (VK) capacities.
- Automatic spray alignment with Quick TeeJet® cap and gasket 114441A-\* -CELR (015 to 06) or 114443A-\* -CELR (08 and 10). Reference page 118 for more information.

## SPRAY PATTERN

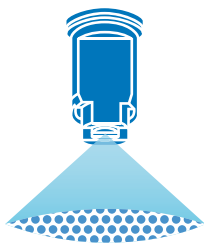

## DROPLET SIZE CLASSIFICATION

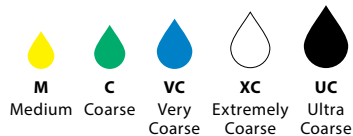

## OPTIMUM SPRAY HEIGHT

 <b>ANGLE</b> 110°	 <b>HEIGHT</b> 20"
--------------------------	--------------------------

## RECOMMENDED PRESSURE RANGE



## MATERIALS AVAILABLE



## HOW TO ORDER

Polymer with VisiFlo color-coding

**A I X R 1 1 0 0 4 V P**

Tip Type	Spray Angle	Capacity Size	Material Code

Polymer with VisiFlo color-coding, includes Quick TeeJet cap and gasket\*

**A I X R 1 1 0 0 3 V P - C E**

Tip Type	Spray Angle	Capacity Size	Material Code	Cap and Gasket Included

\*Reference page 118 for more caps information.

TIP PART NO. (STRAINER MESH SIZE)	PSI	DROP SIZE	CAPACITY ONE TIP IN GPM	CAPACITY ONE TIP IN OZ/MIN	APPLICATION RATE FOR 20" SPRAY TIP SPACING										TURF APPLICATION GALLONS PER 1000 SQ. FT.					
					GALLONS PER ACRE (GPA)															
					4 MPH	5 MPH	6 MPH	8 MPH	10 MPH	12 MPH	15 MPH	20 MPH	2 MPH	3 MPH	4 MPH	5 MPH				
AIXR110015 (100)	15	VC	0.092	12	6.8	5.5	4.6	3.4	2.7	2.3	1.8	1.4	0.31	0.21	0.16	0.13				
	20	VC	0.11	14	8.2	6.5	5.4	4.1	3.3	2.7	2.2	1.6	0.37	0.25	0.19	0.15				
	30	C	0.13	17	9.7	7.7	6.4	4.8	3.9	3.2	2.6	1.9	0.44	0.29	0.22	0.18				
	40	C	0.15	19	11.1	8.9	7.4	5.6	4.5	3.7	3.0	2.2	0.51	0.34	0.26	0.20				
	50	M	0.17	22	12.6	10.1	8.4	6.3	5.0	4.2	3.4	2.5	0.58	0.39	0.29	0.23				
	60	M	0.18	23	13.4	10.7	8.9	6.7	5.3	4.5	3.6	2.7	0.61	0.41	0.31	0.24				
	75	M	0.21	27	15.6	12.5	10.4	7.8	6.2	5.2	4.2	3.1	0.71	0.48	0.36	0.29				
90	M	0.23	29	17.1	13.7	11.4	8.5	6.8	5.7	4.6	3.4	0.78	0.52	0.39	0.31					
AIXR11002 (50)	15	XC	0.12	15	8.9	7.1	5.9	4.5	3.6	3.0	2.4	1.8	0.41	0.27	0.20	0.16				
	20	VC	0.14	18	10.4	8.3	6.9	5.2	4.2	3.5	2.8	2.1	0.48	0.32	0.24	0.19				
	30	VC	0.17	22	12.6	10.1	8.4	6.3	5.0	4.2	3.4	2.5	0.58	0.39	0.29	0.23				
	40	C	0.20	26	14.9	11.9	9.9	7.4	5.9	5.0	4.0	3.0	0.68	0.45	0.34	0.27				
	50	M	0.22	28	16.3	13.1	10.9	8.2	6.5	5.4	4.4	3.3	0.75	0.50	0.37	0.30				
	60	M	0.24	31	17.8	14.3	11.9	8.9	7.1	5.9	4.8	3.6	0.82	0.54	0.41	0.33				
	75	M	0.27	35	20	16.0	13.4	10.0	8.0	6.7	5.3	4.0	0.92	0.61	0.46	0.37				
90	M	0.30	38	22	17.8	14.9	11.1	8.9	7.4	5.9	4.5	1.0	0.68	0.51	0.41					
AIXR110025 (50)	15	XC	0.15	19	11.1	8.9	7.4	5.6	4.5	3.7	3.0	2.2	0.51	0.34	0.26	0.20				
	20	VC	0.18	23	13.4	10.7	8.9	6.7	5.3	4.5	3.6	2.7	0.61	0.41	0.31	0.24				
	30	VC	0.22	28	16.3	13.1	10.9	8.2	6.5	5.4	4.4	3.3	0.75	0.50	0.37	0.30				
	40	C	0.25	32	18.6	14.9	12.4	9.3	7.4	6.2	5.0	3.7	0.85	0.57	0.43	0.34				
	50	M	0.28	36	21	16.6	13.9	10.4	8.3	6.9	5.5	4.2	0.95	0.63	0.48	0.38				
	60	M	0.31	40	23	18.4	15.3	11.5	9.2	7.7	6.1	4.6	1.1	0.70	0.53	0.42				
	75	M	0.34	44	25	20	16.8	12.6	10.1	8.4	6.7	5.0	1.2	0.77	0.58	0.46				
90	M	0.38	49	28	23	18.8	14.1	11.3	9.4	7.5	5.6	1.3	0.86	0.65	0.52					
AIXR11003 (50)	15	XC	0.18	23	13.4	10.7	8.9	6.7	5.3	4.5	3.6	2.7	0.61	0.41	0.31	0.24				
	20	VC	0.21	27	15.6	12.5	10.4	7.8	6.2	5.2	4.2	3.1	0.71	0.48	0.36	0.29				
	30	VC	0.26	33	19.3	15.4	12.9	9.7	7.7	6.4	5.1	3.9	0.88	0.59	0.44	0.35				
	40	C	0.30	38	22	17.8	14.9	11.1	8.9	7.4	5.9	4.5	1.0	0.68	0.51	0.41				
	50	C	0.34	44	25	20	16.8	12.6	10.1	8.4	6.7	5.0	1.2	0.77	0.58	0.46				
	60	M	0.37	47	27	22	18.3	13.7	11.0	9.2	7.3	5.5	1.3	0.84	0.63	0.50				
	75	M	0.41	52	30	24	20	15.2	12.2	10.1	8.1	6.1	1.4	0.93	0.70	0.56				
90	M	0.45	58	33	27	22	16.7	13.4	11.1	8.9	6.7	1.5	1.0	0.77	0.61					
AIXR11004 (50)	15	XC	0.24	31	17.8	14.3	11.9	8.9	7.1	5.9	4.8	3.6	0.82	0.54	0.41	0.33				
	20	VC	0.28	36	21	16.6	13.9	10.4	8.3	6.9	5.5	4.2	0.95	0.63	0.48	0.38				
	30	VC	0.35	45	26	21	17.3	13.0	10.4	8.7	6.9	5.2	1.2	0.79	0.60	0.48				
	40	C	0.40	51	30	24	19.8	14.9	11.9	9.9	7.9	5.9	1.4	0.91	0.68	0.54				
	50	C	0.45	58	33	27	22	16.7	13.4	11.1	8.9	6.7	1.5	1.0	0.77	0.61				
	60	C	0.49	63	36	29	24	18.2	14.6	12.1	9.7	7.3	1.7	1.1	0.83	0.67				
	75	M	0.55	70	41	33	27	20	16.3	13.6	10.9	8.2	1.9	1.2	0.94	0.75				
90	M	0.60	77	45	36	30	22	17.8	14.9	11.9	8.9	2.0	1.4	1.0	0.82					
AIXR11005 (50)	15	XC	0.31	40	23	18.4	15.3	11.5	9.2	7.7	6.1	4.6	1.1	0.70	0.53	0.42				
	20	XC	0.35	45	26	21	17.3	13.0	10.4	8.7	6.9	5.2	1.2	0.79	0.60	0.48				
	30	VC	0.43	55	32	26	21	16.0	12.8	10.6	8.5	6.4	1.5	0.97	0.73	0.58				
	40	VC	0.50	64	37	30	25	18.6	14.9	12.4	9.9	7.4	1.7	1.1	0.85	0.68				
	50	C	0.56	72	42	33	28	21	16.6	13.9	11.1	8.3	1.9	1.3	0.95	0.76				
	60	C	0.61	78	45	36	30	23	18.1	15.1	12.1	9.1	2.1	1.4	1.0	0.83				
	75	M	0.68	87	50	40	34	25	20	16.8	13.5	10.1	2.3	1.5	1.2	0.92				
90	M	0.75	96	56	45	37	28	22	18.6	14.9	11.1	2.6	1.7	1.3	1.0					
AIXR11006 (50)	15	XC	0.37	47	27	22	18.3	13.7	11.0	9.2	7.3	5.5	1.3	0.84	0.63	0.50				
	20	XC	0.42	54	31	25	21	15.6	12.5	10.4	8.3	6.2	1.4	0.95	0.71	0.57				
	30	VC	0.52	67	39	31	26	19.3	15.4	12.9	10.3	7.7	1.8	1.2	0.88	0.71				
	40	VC	0.60	77	45	36	30	22	17.8	14.9	11.9	8.9	2.0	1.4	1.0	0.82				
	50	VC	0.67	86	50	40	33	25	19.9	16.6	13.3	9.9	2.3	1.5	1.1	0.91				
	60	C	0.73	93	54	43	36	27	22	18.1	14.5	10.8	2.5	1.7	1.2	0.99				
	75	C	0.82	105	61	49	41	30	24	20	16.2	12.2	2.8	1.9	1.4	1.1				
90	C	0.90	115	67	53	45	33	27	22	17.8	13.4	3.1	2.0	1.5	1.2					
AIXR11008 (50)	15	UC	0.49	63	36	29	24	18.2	14.6	12.1	9.7	7.3	1.7	1.1	0.83	0.67				
	20	XC	0.57	73	42	34	28	21	16.9	14.1	11.3	8.5	1.9	1.3	0.97	0.78				
	30	XC	0.69	88	51	41	34	26	20	17.1	13.7	10.2	2.3	1.6	1.2	0.94				
	40	VC	0.80	102	59	48	40	30	24	19.8	15.8	11.9	2.7	1.8	1.4	1.1				
	50	VC	0.89	114	66	53	44	33	26	22	17.6	13.2	3.0	2.0	1.5	1.2				
	60	VC	0.98	125	72	58	49	36	29	24	19.4	14.6	3.3	2.2	1.7	1.3				
	75	C	1.10	141	82	65	54	41	33	27	22	16.3	3.7	2.5	1.9	1.5				
90	C	1.20	154	89	71	59	45	36	30	24	17.8	4.1	2.7	2.0	1.6					
AIXR11010	15	UC	0.61	78	45	36	30	23	18.1	15.1	12.1	9.1	2.1	1.4	1.0	0.83				
	20	UC	0.71	91	53	42	35	26	21	17.6	14.1	10.5	2.4	1.6	1.2	0.97				
	30	XC	0.87	111	65	52	43	32	26	22	17.2	12.9	3.0	2.0	1.5	1.2				
	40	VC	1.00	128	74	59	50	37	30	25	19.8	14.9	3.4	2.3	1.7	1.4				
	50	VC	1.12	143	83	67	55	42	33	28	22	16.6	3.8	2.5	1.9	1.5				
	60	VC	1.22	156	91	72	60	45	36	30	24	18.1	4.2	2.8	2.1	1.7				
	75	VC	1.37	175	102	81	68	51	41	34	27	20	4.7	3.1	2.3	1.9				
90	C	1.50	192	111	89	74	56	45	37	30	22	5.1	3.4	2.6	2.0					

**Note:** Always double check your application rates. Droplet size classification shown is based on ISO 25358. Droplet size classification standard is subject to change. Tabulations are based on spraying water at 70°F. See technical information (pages 179–202) for droplet size classification, useful formulas and other technical information.

## Typical Applications



**HERBICIDE**  
SOIL APPLIED  
**VERY GOOD**  
SYSTEMIC  
**EXCELLENT**



**FUNGICIDE**  
SYSTEMIC  
**GOOD**



**INSECTICIDE**  
SYSTEMIC  
**VERY GOOD**



**FERTILIZER**  
BROADCAST  
**VERY GOOD**



**DRIFT CONTROL**  
**EXCELLENT**



## FEATURES

- Stainless steel insert produces a tapered edge flat spray pattern for uniform coverage in broadcast spraying.
- Air induction spray tip, producing large air-filled droplets through the use of a Venturi air aspirator more resistant to drift.
- Available in 80° or 110° spray angles with a Polymer insert holder and pre-orifice with VisiFlo® color-coding.
- Available in eight 110° versions, and seven 80° versions.
- Automatic spray alignment with 114443A\*-CEL R Quick TeeJet® cap and gasket. Reference page 118 for more information.

## SPRAY PATTERN

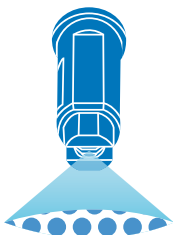

## DROPLET SIZE CLASSIFICATION



## OPTIMUM SPRAY HEIGHT

ANGLE	20" SPACING HEIGHT
80°	30"
110°	20"

## RECOMMENDED PRESSURE RANGE



## MATERIALS AVAILABLE



## HOW TO ORDER

Stainless Steel with VisiFlo color-coding

A 1 1 0 0 4 - V S

Tip Spray Capacity Material  
Type Angle Size Code

Stainless Steel with VisiFlo color-coding

A 1 8 0 0 4 V S

Tip Spray Capacity Material  
Type Angle Size Code



TIP PART NO. (STRAINER MESH SIZE)	PSI	DROP SIZE		CAPACITY ONE TIP IN GPM	CAPACITY ONE TIP IN OZ/MIN	APPLICATION RATE FOR 20" SPRAY TIP SPACING											
		80°	110°			GALLONS PER ACRE (GPA)								TURF APPLICATION GALLONS PER 1000 SQ. FT.			
						4 MPH	5 MPH	6 MPH	8 MPH	10 MPH	12 MPH	15 MPH	20 MPH	2 MPH	3 MPH	4 MPH	5 MPH
AI80015 AI110015 (100)	30	XC	XC	0.13	17	9.7	7.7	6.4	4.8	3.9	3.2	2.6	1.9	0.44	0.29	0.22	0.18
	40	XC	XC	0.15	19	11.1	8.9	7.4	5.6	4.5	3.7	3.0	2.2	0.51	0.34	0.26	0.20
	50	VC	VC	0.17	22	12.6	10.1	8.4	6.3	5.0	4.2	3.4	2.5	0.58	0.39	0.29	0.23
	60	VC	VC	0.18	23	13.4	10.7	8.9	6.7	5.3	4.5	3.6	2.7	0.61	0.41	0.31	0.24
	70	VC	C	0.20	26	14.9	11.9	9.9	7.4	5.9	5.0	4.0	3.0	0.68	0.45	0.34	0.27
	80	C	C	0.21	27	15.6	12.5	10.4	7.8	6.2	5.2	4.2	3.1	0.71	0.48	0.36	0.29
	90	C	C	0.23	29	17.1	13.7	11.4	8.5	6.8	5.7	4.6	3.4	0.78	0.52	0.39	0.31
100	C	C	0.24	31	17.8	14.3	11.9	8.9	7.1	5.9	4.8	3.6	0.82	0.54	0.41	0.33	
115	C	M	0.25	32	18.6	14.9	12.4	9.3	7.4	6.2	5.0	3.7	0.85	0.57	0.43	0.34	
AI8002 AI11002 (50)	30	XC	XC	0.17	22	12.6	10.1	8.4	6.3	5.0	4.2	3.4	2.5	0.58	0.39	0.29	0.23
	40	XC	XC	0.20	26	14.9	11.9	9.9	7.4	5.9	5.0	4.0	3.0	0.68	0.45	0.34	0.27
	50	VC	VC	0.22	28	16.3	13.1	10.9	8.2	6.5	5.4	4.4	3.3	0.75	0.50	0.37	0.30
	60	VC	VC	0.24	31	17.8	14.3	11.9	8.9	7.1	5.9	4.8	3.6	0.82	0.54	0.41	0.33
	70	VC	C	0.26	33	19.3	15.4	12.9	9.7	7.7	6.4	5.1	3.9	0.88	0.59	0.44	0.35
	80	VC	C	0.28	36	21	16.6	13.9	10.4	8.3	6.9	5.5	4.2	0.95	0.63	0.48	0.38
	90	C	C	0.30	38	22	17.8	14.9	11.1	8.9	7.4	5.9	4.5	1.0	0.68	0.51	0.41
100	C	C	0.32	41	24	19.0	15.8	11.9	9.5	7.9	6.3	4.8	1.1	0.73	0.54	0.44	
115	C	M	0.34	44	25	20	16.8	12.6	10.1	8.4	6.7	5.0	1.2	0.77	0.58	0.46	
AI80025 AI110025 (50)	30	XC	XC	0.22	28	16.3	13.1	10.9	8.2	6.5	5.4	4.4	3.3	0.75	0.50	0.37	0.30
	40	XC	XC	0.25	32	18.6	14.9	12.4	9.3	7.4	6.2	5.0	3.7	0.85	0.57	0.43	0.34
	50	VC	VC	0.28	36	21	16.6	13.9	10.4	8.3	6.9	5.5	4.2	0.95	0.63	0.48	0.38
	60	VC	VC	0.31	40	23	18.4	15.3	11.5	9.2	7.7	6.1	4.6	1.1	0.70	0.53	0.42
	70	VC	C	0.33	42	25	19.6	16.3	12.3	9.8	8.2	6.5	4.9	1.1	0.75	0.56	0.45
	80	VC	C	0.35	45	26	21	17.3	13.0	10.4	8.7	6.9	5.2	1.2	0.79	0.60	0.48
	90	C	C	0.38	49	28	23	18.8	14.1	11.3	9.4	7.5	5.6	1.3	0.86	0.65	0.52
100	C	C	0.40	51	30	24	19.8	14.9	11.9	9.9	7.9	5.9	1.4	0.91	0.68	0.54	
115	C	M	0.42	54	31	25	21	15.6	12.5	10.4	8.3	6.2	1.4	0.95	0.71	0.57	
AI8003 AI11003 (50)	30	XC	XC	0.26	33	19.3	15.4	12.9	9.7	7.7	6.4	5.1	3.9	0.88	0.59	0.44	0.35
	40	XC	XC	0.30	38	22	17.8	14.9	11.1	8.9	7.4	5.9	4.5	1.0	0.68	0.51	0.41
	50	VC	VC	0.34	44	25	20	16.8	12.6	10.1	8.4	6.7	5.0	1.2	0.77	0.58	0.46
	60	VC	VC	0.37	47	27	22	18.3	13.7	11.0	9.2	7.3	5.5	1.3	0.84	0.63	0.50
	70	VC	C	0.40	51	30	24	19.8	14.9	11.9	9.9	7.9	5.9	1.4	0.91	0.68	0.54
	80	VC	C	0.42	54	31	25	21	15.6	12.5	10.4	8.3	6.2	1.4	0.95	0.71	0.57
	90	C	C	0.45	58	33	27	22	16.7	13.4	11.1	8.9	6.7	1.5	1.0	0.77	0.61
100	C	C	0.47	60	35	28	23	17.4	14.0	11.6	9.3	7.0	1.6	1.1	0.80	0.64	
115	C	M	0.51	65	38	30	25	18.9	15.1	12.6	10.1	7.6	1.7	1.2	0.87	0.69	
AI8004 AI11004 (50)	30	XC	XC	0.35	45	26	21	17.3	13.0	10.4	8.7	6.9	5.2	1.2	0.79	0.60	0.48
	40	XC	XC	0.40	51	30	24	19.8	14.9	11.9	9.9	7.9	5.9	1.4	0.91	0.68	0.54
	50	VC	VC	0.45	58	33	27	22	16.7	13.4	11.1	8.9	6.7	1.5	1.0	0.77	0.61
	60	VC	VC	0.49	63	36	29	24	18.2	14.6	12.1	9.7	7.3	1.7	1.1	0.83	0.67
	70	VC	C	0.53	68	39	31	26	19.7	15.7	13.1	10.5	7.9	1.8	1.2	0.90	0.72
	80	VC	C	0.57	73	42	34	28	21	16.9	14.1	11.3	8.5	1.9	1.3	0.97	0.78
	90	C	C	0.60	77	45	36	30	22	17.8	14.9	11.9	8.9	2.0	1.4	1.0	0.82
100	C	C	0.63	81	47	37	31	23	18.7	15.6	12.5	9.4	2.1	1.4	1.1	0.86	
115	C	M	0.68	87	50	40	34	25	20	16.8	13.5	10.1	2.3	1.5	1.2	0.92	
AI8005 AI11005 (50)	30	XC	XC	0.43	55	32	26	21	16.0	12.8	10.6	8.5	6.4	1.5	0.97	0.73	0.58
	40	XC	XC	0.50	64	37	30	25	18.6	14.9	12.4	9.9	7.4	1.7	1.1	0.85	0.68
	50	VC	VC	0.56	72	42	33	28	21	16.6	13.9	11.1	8.3	1.9	1.3	0.95	0.76
	60	VC	VC	0.61	78	45	36	30	23	18.1	15.1	12.1	9.1	2.1	1.4	1.0	0.83
	70	VC	VC	0.66	84	49	39	33	25	19.6	16.3	13.1	9.8	2.2	1.5	1.1	0.90
	80	VC	VC	0.71	91	53	42	35	26	21	17.6	14.1	10.5	2.4	1.6	1.2	0.97
	90	C	C	0.75	96	56	45	37	28	22	18.6	14.9	11.1	2.6	1.7	1.3	1.0
100	C	C	0.79	101	59	47	39	29	23	19.6	15.6	11.7	2.7	1.8	1.3	1.1	
115	C	C	0.85	109	63	50	42	32	25	21	16.8	12.6	2.9	1.9	1.4	1.2	
AI8006 AI11006 (50)	30	XC	XC	0.52	67	39	31	26	19.3	15.4	12.9	10.3	7.7	1.8	1.2	0.88	0.71
	40	XC	XC	0.60	77	45	36	30	22	17.8	14.9	11.9	8.9	2.0	1.4	1.0	0.82
	50	VC	VC	0.67	86	50	40	33	25	19.9	16.6	13.3	9.9	2.3	1.5	1.1	0.91
	60	VC	VC	0.73	93	54	43	36	27	22	18.1	14.5	10.8	2.5	1.7	1.2	0.99
	70	VC	VC	0.79	101	59	47	39	29	23	19.6	15.6	11.7	2.7	1.8	1.3	1.1
	80	VC	VC	0.85	109	63	50	42	32	25	21	16.8	12.6	2.9	1.9	1.4	1.2
	90	VC	C	0.90	115	67	53	45	33	27	22	17.8	13.4	3.1	2.0	1.5	1.2
100	VC	C	0.95	122	71	56	47	35	28	24	18.8	14.1	3.2	2.2	1.6	1.3	
115	VC	C	1.02	131	76	61	50	38	30	25	20	15.1	3.5	2.3	1.7	1.4	
AI11008 (50)	30		XC	0.69	88	51	41	34	26	20	17.1	13.7	10.2	2.3	1.6	1.2	0.94
	40		XC	0.80	102	59	48	40	30	24	19.8	15.8	11.9	2.7	1.8	1.4	1.1
	50		VC	0.89	114	66	53	44	33	26	22	17.6	13.2	3.0	2.0	1.5	1.2
	60		VC	0.98	125	73	58	49	36	29	24	19.4	14.6	3.3	2.2	1.7	1.3
	70		VC	1.06	136	79	63	52	39	31	26	21	15.7	3.6	2.4	1.8	1.4
	80		VC	1.13	145	84	67	56	42	34	28	22	16.8	3.8	2.6	1.9	1.5
	90		VC	1.20	154	89	71	59	45	36	30	24	17.8	4.1	2.7	2.0	1.6
100		C	1.26	161	94	75	62	47	37	31	25	18.7	4.3	2.9	2.1	1.7	
115		C	1.36	174	101	81	67	50	40	34	27	20	4.6	3.1	2.3	1.8	

**Note:** Always double check your application rates. Droplet size classification shown is based on ISO 25358. Droplet size classification standard is subject to change. Tabulations are based on spraying water at 70°F. See technical information (pages 179–202) for droplet size classification, useful formulas and other technical information.

# AIC TeeJet® AIR INDUCTION FLAT SPRAY

BROADCAST NOZZLES

## Typical Applications



**HERBICIDE**  
SOIL APPLIED  
**VERY GOOD**  
SYSTEMIC  
**EXCELLENT**



**FUNGICIDE**  
SYSTEMIC  
**GOOD**



**INSECTICIDE**  
SYSTEMIC  
**VERY GOOD**



**FERTILIZER**  
BROADCAST  
**VERY GOOD**



**DRIFT CONTROL**  
**EXCELLENT**



## FEATURES

- Produces a 110° tapered edge flat spray pattern for uniform coverage in broadcast spraying applications.
- Air induction spray tip, producing large air-filled droplets through the use of a Venturi air aspirator more resistant to drift.
- AI TeeJet nozzle molded into Quick TeeJet® cap provides automatic spray alignment.
- Available with a polymer insert holder with stainless steel (015–15 capacities), ceramic (025–05 capacities) or polymer (02–10 capacities) inserts.
- Includes tightly fitting gasket that stays put and assures a good seal. Replacement gasket part number: CP19438-1-EPR

## SPRAY PATTERN



## DROPLET SIZE CLASSIFICATION

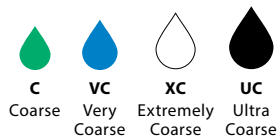

## OPTIMUM SPRAY HEIGHT

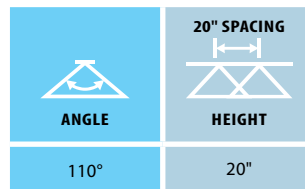

## RECOMMENDED PRESSURE RANGE



## MATERIALS AVAILABLE

- VS** STAINLESS STEEL
- VP** POLYMER
- VK** CERAMIC

## HOW TO ORDER

Stainless Steel with VisiFlo® color-coding

A I C 1 1 0 0 4 - V S

Tip Type	Spray Angle	Capacity Size	Material Code
----------	-------------	---------------	---------------

Ceramic with VisiFlo color-coding

A I C 1 1 0 0 3 - V K

Tip Type	Spray Angle	Capacity Size	Material Code
----------	-------------	---------------	---------------

Polymer with VisiFlo color-coding

A I C 1 1 0 0 3 - V P

Tip Type	Spray Angle	Capacity Size	Material Code
----------	-------------	---------------	---------------

TIP PART NO. (STRAINER MESH SIZE)	PSI	DROP SIZE	CAPACITY ONE TIP IN GPM	CAPACITY ONE TIP IN OZ/MIN	APPLICATION RATE FOR 20" SPRAY TIP SPACING															
					GALLONS PER ACRE (GPA)								TURF APPLICATION GALLONS PER 1000 SQ. FT.							
					4 MPH	5 MPH	6 MPH	8 MPH	10 MPH	12 MPH	15 MPH	20 MPH	2 MPH	3 MPH	4 MPH	5 MPH				
AIC110015 (100)	30	XC	0.13	17	9.7	7.7	6.4	4.8	3.9	3.2	2.6	1.9	0.44	0.29	0.22	0.18				
	40	XC	0.15	19	11.1	8.9	7.4	5.6	4.5	3.7	3.0	2.2	0.51	0.34	0.26	0.20				
	50	VC	0.17	22	12.6	10.1	8.4	6.3	5.0	4.2	3.4	2.5	0.58	0.39	0.29	0.23				
	60	VC	0.18	23	13.4	10.7	8.9	6.7	5.3	4.5	3.6	2.7	0.61	0.41	0.31	0.24				
	70	VC	0.20	26	14.9	11.9	9.9	7.4	5.9	5.0	4.0	3.0	0.68	0.45	0.34	0.27				
	80	C	0.21	27	15.6	12.5	10.4	7.8	6.2	5.2	4.2	3.1	0.71	0.48	0.36	0.29				
	90	C	0.23	29	17.1	13.7	11.4	8.5	6.8	5.7	4.6	3.4	0.78	0.52	0.39	0.31				
100	C	0.24	31	17.8	14.3	11.9	8.9	7.1	5.9	4.8	3.6	0.82	0.54	0.41	0.33					
115	C	0.25	32	18.6	14.9	12.4	9.3	7.4	6.2	5.0	3.7	0.85	0.57	0.43	0.34					
AIC11002 (50)	30	XC	0.17	22	12.6	10.1	8.4	6.3	5.0	4.2	3.4	2.5	0.58	0.39	0.29	0.23				
	40	XC	0.20	26	14.9	11.9	9.9	7.4	5.9	5.0	4.0	3.0	0.68	0.45	0.34	0.27				
	50	VC	0.22	28	16.3	13.1	10.9	8.2	6.5	5.4	4.4	3.3	0.75	0.50	0.37	0.30				
	60	VC	0.24	31	17.8	14.3	11.9	8.9	7.1	5.9	4.8	3.6	0.82	0.54	0.41	0.33				
	70	VC	0.26	33	19.3	15.4	12.9	9.7	7.7	6.4	5.1	3.9	0.88	0.59	0.44	0.35				
	80	C	0.28	36	21	16.6	13.9	10.4	8.3	6.9	5.5	4.2	1.0	0.63	0.48	0.38				
	90	C	0.30	38	22	17.8	14.9	11.1	8.9	7.4	5.9	4.5	1.0	0.68	0.51	0.41				
100	C	0.32	41	24	19.0	15.8	11.9	9.5	7.9	6.3	4.8	1.1	0.73	0.54	0.44					
115	C	0.34	44	25	20	16.8	12.6	10.1	8.4	6.7	5.0	1.2	0.77	0.58	0.46					
AIC110025 (50)	30	XC	0.22	28	16.3	13.1	10.9	8.2	6.5	5.4	4.4	3.3	0.75	0.50	0.37	0.30				
	40	XC	0.25	32	18.6	14.9	12.4	9.3	7.4	6.2	5.0	3.7	0.85	0.57	0.43	0.34				
	50	VC	0.28	36	21	16.6	13.9	10.4	8.3	6.9	5.5	4.2	0.95	0.63	0.48	0.38				
	60	VC	0.31	40	23	18.4	15.3	11.5	9.2	7.7	6.1	4.6	1.1	0.70	0.53	0.42				
	70	VC	0.33	42	25	19.6	16.3	12.3	9.8	8.2	6.5	4.9	1.1	0.75	0.56	0.45				
	80	C	0.35	45	26	21	17.3	13.0	10.4	8.7	6.9	5.2	1.2	0.79	0.60	0.48				
	90	C	0.38	49	28	23	18.8	14.1	11.3	9.4	7.5	5.6	1.3	0.86	0.65	0.52				
100	C	0.40	51	30	24	19.8	14.9	11.9	9.9	7.9	5.9	1.4	0.91	0.68	0.54					
115	C	0.42	54	31	25	21	15.6	12.5	10.4	8.3	6.2	1.4	0.95	0.71	0.57					
AIC11003 (50)	30	XC	0.26	33	19.3	15.4	12.9	9.7	7.7	6.4	5.1	3.9	0.88	0.59	0.44	0.35				
	40	XC	0.30	38	22	17.8	14.9	11.1	8.9	7.4	5.9	4.5	1.0	0.68	0.51	0.41				
	50	VC	0.34	44	25	20	16.8	12.6	10.1	8.4	6.7	5.0	1.2	0.77	0.58	0.46				
	60	VC	0.37	47	27	22	18.3	13.7	11.0	9.2	7.3	5.5	1.3	0.84	0.63	0.50				
	70	VC	0.40	51	30	24	19.8	14.9	11.9	9.9	7.9	5.9	1.4	0.91	0.68	0.54				
	80	C	0.42	54	31	25	21	15.6	12.5	10.4	8.3	6.2	1.4	0.95	0.71	0.57				
	90	C	0.45	58	33	27	22	16.7	13.4	11.1	8.9	6.7	1.5	1.0	0.77	0.61				
100	C	0.47	60	35	28	23	17.4	14.0	11.6	9.3	7.0	1.6	1.1	0.80	0.64					
115	C	0.51	65	38	30	25	18.9	15.1	12.6	10.1	7.6	1.7	1.2	0.87	0.69					
AIC11004 (50)	30	XC	0.35	45	26	21	17.3	13.0	10.4	8.7	6.9	5.2	1.2	0.79	0.60	0.48				
	40	XC	0.40	51	30	24	19.8	14.9	11.9	9.9	7.9	5.9	1.4	0.91	0.68	0.54				
	50	VC	0.45	58	33	27	22	16.7	13.4	11.1	8.9	6.7	1.5	1.0	0.77	0.61				
	60	VC	0.49	63	36	29	24	18.2	14.6	12.1	9.7	7.3	1.7	1.1	0.83	0.67				
	70	VC	0.53	68	39	31	26	19.7	15.7	13.1	10.5	7.9	1.8	1.2	0.90	0.72				
	80	C	0.57	73	42	34	28	21	16.9	14.1	11.3	8.5	1.9	1.3	0.97	0.78				
	90	C	0.60	77	45	36	30	22	17.8	14.9	11.9	8.9	2.0	1.4	1.0	0.82				
100	C	0.63	81	47	37	31	23	18.7	15.6	12.5	9.4	2.1	1.4	1.1	0.86					
115	C	0.68	87	50	40	34	25	20	16.8	13.5	10.1	2.3	1.5	1.2	0.92					
AIC11005 (50)	30	XC	0.43	55	32	26	21	16.0	12.8	10.6	8.5	6.4	1.5	0.97	0.73	0.58				
	40	XC	0.50	64	37	30	25	18.6	14.9	12.4	9.9	7.4	1.7	1.1	0.85	0.68				
	50	VC	0.56	72	42	33	28	21	16.6	13.9	11.1	8.3	1.9	1.3	0.95	0.76				
	60	VC	0.61	78	45	36	30	23	18.1	15.1	12.1	9.1	2.1	1.4	1.0	0.83				
	70	VC	0.66	84	49	39	33	25	19.6	16.3	13.1	9.8	2.2	1.5	1.1	0.90				
	80	VC	0.71	91	53	42	35	26	21	17.6	14.1	10.5	2.4	1.6	1.2	0.97				
	90	C	0.75	96	56	45	37	28	22	18.6	14.9	11.1	2.6	1.7	1.3	1.0				
100	C	0.79	101	59	47	39	29	23	19.6	15.6	11.7	2.7	1.8	1.3	1.1					
115	C	0.85	109	63	50	42	32	25	21	16.8	12.6	2.9	1.9	1.4	1.2					
AIC11006 (50)	30	XC	0.52	67	39	31	26	19.3	15.4	12.9	10.3	7.7	1.8	1.2	0.88	0.71				
	40	XC	0.60	77	45	36	30	22	17.8	14.9	11.9	8.9	2.0	1.4	1.0	0.82				
	50	VC	0.67	86	50	40	33	25	19.9	16.6	13.3	9.9	2.3	1.5	1.1	0.91				
	60	VC	0.73	93	54	43	36	27	22	18.1	14.5	10.8	2.5	1.7	1.2	0.99				
	70	VC	0.79	101	59	47	39	29	23	19.6	15.6	11.7	2.7	1.8	1.3	1.1				
	80	VC	0.85	109	63	50	42	32	25	21	16.8	12.6	2.9	1.9	1.4	1.2				
	90	C	0.90	115	67	53	45	33	27	22	17.8	13.4	3.1	2.0	1.5	1.2				
100	C	0.95	122	71	56	47	35	28	24	18.8	14.1	3.2	2.2	1.6	1.3					
115	C	1.02	131	76	61	50	38	30	25	20	15.1	3.5	2.3	1.7	1.4					
AIC11008 (50)	30	XC	0.69	88	51	41	34	26	20	17.1	13.7	10.2	2.3	1.6	1.2	0.94				
	40	XC	0.80	102	59	48	40	30	24	19.8	15.8	11.9	2.7	1.8	1.4	1.1				
	50	XC	0.89	114	66	53	44	33	26	22	17.6	13.2	3.0	2.0	1.5	1.2				
	60	VC	0.98	125	73	58	49	36	29	24	19.4	14.6	3.3	2.2	1.7	1.3				
	70	VC	1.06	136	79	63	52	39	31	26	21	15.7	3.6	2.4	1.8	1.4				
	80	VC	1.13	145	84	67	56	42	34	28	22	16.8	3.8	2.6	1.9	1.5				
	90	VC	1.20	154	89	71	59	45	36	30	24	17.8	4.1	2.7	2.0	1.6				
100	VC	1.26	161	94	75	62	47	37	31	25	18.7	4.3	2.9	2.1	1.7					
115	C	1.36	174	101	81	67	50	40	34	27	20	4.6	3.1	2.3	1.8					
AIC11010	30	XC	0.87	111	65	52	43	32	26	22	17.2	12.9	3.0	2.0	1.5	1.2				
	40	XC	1.00	128	74	59	50	37	30	25	19.8	14.9	3.4	2.3	1.7	1.4				
	50	XC	1.12	143	83	67	55	42	33	28	22	16.6	3.8	2.5	1.9	1.5				
	60	XC	1.22	156	91	72	60	45	36	30	24	18.1	4.1	2.8	2.1	1.7				
	70	VC	1.32	169	98	78	65	49	39	33	26	19.6	4.5	3.0	2.2	1.8				
	80	VC	1.41	180	105	84	70	52	42	35	28	21	4.8	3.2	2.4	1.9				
	90	VC	1.50	192	111	89	74	56	45	37	30	22	5.1	3.4	2.6	2.0				
100	VC	1.58	202	117	94	78	59	47	39	31	23	5.4	3.6	2.7	2.1					
115	VC	1.70	218	126	101	84	63	50	42	34	25	5.8	3.9	2.9	2.3					
AIC11015	30	XC	1.30	166	97	77	64	48	39	32	26	19.3	4.4	2.9	2.2	1.8				
	40	XC	1.50	192	111	89	74	56	45	37	30	22	5.1	3.4	2.6	2.0				
	50	XC	1.68	215	125	100	83	62	50	42	33	25	5.7	3.8	2.9	2.3				
	60	XC	1.84	236	137	109	91	68	55	46	36	27	6.3	4.2	3.1	2.5				
	70	VC	1.98	253	147	118	98	74	59	49	39	29	6.7	4.5	3.4	2.7				
	80	VC	2.12	271	157	126	105	79	63	52	42	31	7.2	4.8	3.6	2.9				
	90	VC	2.25	288	167	134	111	84	67	56	45	33	7.7	5.1	3.8	3.1				
100	VC	2.37	303	176	141	117	88	70	59	47	35	8.1	5.4	4.0						



# Turbo TeeJet® Induction FLAT SPRAY



BROADCAST NOZZLES

## Typical Applications



**HERBICIDE**  
SOIL APPLIED  
**EXCELLENT**  
SYSTEMIC  
**EXCELLENT**



**FERTILIZER**  
BROADCAST  
**EXCELLENT**



**DRIFT CONTROL**  
**EXCELLENT**



**PWM APPROVED**



## FEATURES

- 110° wide angle, air induction, tapered flat spray tip pattern based on the patented outlet orifice design of the original Turbo TeeJet® nozzle.
- Provides excellent drift control and produces less than 2% of driftable fines.
- Patented orifice design provides large, round passages to minimize plugging and improved wear life.
- Depending on the chemical, produces large air-filled droplets through a Venturi air aspirator resulting in less drift.
- Compact size to prevent tip damage.
- Removable pre-orifice.
- Available in nine VisiFlo® Polymer (VP) capacities.
- Automatic spray alignment with Quick TeeJet cap and gasket 115835A-\* - CELR (015-06), or 114502A (08-10). The 115835A exclusive cap allows for straight through assembly, no need to rotate 90° to insert into the cap. Reference page 118 for more caps information.

## SPRAY PATTERN

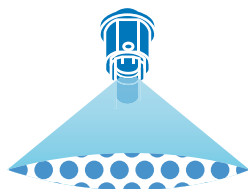

## DROPLET SIZE CLASSIFICATION

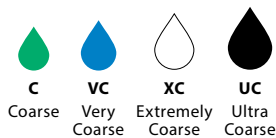

## OPTIMUM SPRAY HEIGHT

<p><b>ANGLE</b></p>	<p>20" SPACING</p> <p><b>HEIGHT</b></p>
110°	20"

## RECOMMENDED PRESSURE RANGE



## MATERIALS AVAILABLE



## HOW TO ORDER

Polymer with VisiFlo color-coding

**TTI11004-VP**

Tip Type	Spray Angle	Capacity Size	Material Code
----------	-------------	---------------	---------------

Polymer with VisiFlo color-coding, includes Quick TeeJet® cap and gasket\*

**TTI11003-VP-CE**

Tip Type	Spray Angle	Capacity Size	Material Code	Cap and Gasket Included
----------	-------------	---------------	---------------	-------------------------

\*Reference page 118 for more caps information.

# Turbo TeeJet® Induction FLAT SPRAY



TIP PART NO. (STRAINER MESH SIZE)	PSI	DROPSIZE	CAPACITY ONE TIP IN GPM	CAPACITY ONE TIP IN OZ/MIN	APPLICATION RATE FOR 20" SPRAY TIP SPACING															
					GALLONS PER ACRE (GPA)								TURF APPLICATION GALLONS PER 1000 SQ. FT.							
					4 MPH	5 MPH	6 MPH	8 MPH	10 MPH	12 MPH	15 MPH	20 MPH	2 MPH	3 MPH	4 MPH	5 MPH				
TTI11001 (100)	15	UC	0.061	7.8	4.5	3.6	3.0	2.3	1.8	1.5	1.2	0.91	0.21	0.14	0.10	0.08				
	20	UC	0.071	9.1	5.3	4.2	3.5	2.6	2.1	1.8	1.4	1.1	0.24	0.16	0.12	0.10				
	30	UC	0.087	11	6.5	5.2	4.3	3.2	2.6	2.2	1.7	1.3	0.30	0.20	0.15	0.12				
	40	XC	0.10	13	7.4	5.9	5.0	3.7	3.0	2.5	2.0	1.5	0.34	0.23	0.17	0.14				
	50	XC	0.11	14	8.2	6.5	5.4	4.1	3.3	2.7	2.2	1.6	0.37	0.25	0.19	0.15				
	60	VC	0.12	15	8.9	7.1	5.9	4.5	3.6	3.0	2.4	1.8	0.41	0.27	0.20	0.16				
	70	VC	0.13	17	9.7	7.7	6.4	4.8	3.9	3.2	2.6	1.9	0.44	0.29	0.22	0.18				
	80	VC	0.14	18	10.4	8.3	6.9	5.2	4.2	3.5	2.8	2.1	0.48	0.32	0.24	0.19				
	90	VC	0.15	19	11.1	8.9	7.4	5.6	4.5	3.7	3.0	2.2	0.51	0.34	0.26	0.20				
	100	C	0.16	20	11.9	9.5	7.9	5.9	4.8	4.0	3.2	2.4	0.54	0.36	0.27	0.22				
TTI110015 (100)	15	UC	0.092	12	6.8	5.5	4.6	3.4	2.7	2.3	1.8	1.4	0.31	0.21	0.16	0.13				
	20	UC	0.11	14	8.2	6.5	5.4	4.1	3.3	2.7	2.2	1.6	0.37	0.25	0.19	0.15				
	30	UC	0.13	17	9.7	7.7	6.4	4.8	3.9	3.2	2.6	1.9	0.44	0.29	0.22	0.18				
	40	XC	0.15	19	11.1	8.9	7.4	5.6	4.5	3.7	3.0	2.2	0.51	0.34	0.26	0.20				
	50	XC	0.17	22	12.6	10.1	8.4	6.3	5.0	4.2	3.4	2.5	0.58	0.39	0.29	0.23				
	60	XC	0.18	23	13.4	10.7	8.9	6.7	5.0	4.2	3.4	2.5	0.61	0.41	0.31	0.24				
	70	VC	0.20	26	14.9	11.9	9.9	7.4	5.9	5.0	4.0	3.0	0.68	0.45	0.34	0.27				
	80	VC	0.21	27	15.6	12.5	10.4	7.8	6.2	5.2	4.2	3.1	0.71	0.48	0.36	0.29				
	90	VC	0.23	29	17.1	13.7	11.4	8.5	6.8	5.7	4.6	3.4	0.78	0.52	0.39	0.31				
	100	VC	0.24	31	17.8	14.3	11.9	8.9	7.1	5.9	4.8	3.6	0.82	0.54	0.41	0.33				
TTI11002 (50)	15	UC	0.12	15	8.9	7.1	5.9	4.5	3.6	3.0	2.4	1.8	0.41	0.27	0.20	0.16				
	20	UC	0.14	18	10.4	8.3	6.9	5.2	4.2	3.5	2.8	2.1	0.48	0.32	0.24	0.19				
	30	UC	0.17	22	12.6	10.1	8.4	6.3	5.0	4.2	3.4	2.5	0.58	0.39	0.29	0.23				
	40	XC	0.20	26	14.9	11.9	9.9	7.4	5.9	5.0	4.0	3.0	0.68	0.45	0.34	0.27				
	50	XC	0.22	28	16.3	13.1	10.9	8.2	6.5	5.4	4.4	3.3	0.75	0.50	0.37	0.30				
	60	XC	0.24	31	17.8	14.3	11.9	8.9	7.1	5.9	4.8	3.6	0.82	0.54	0.41	0.33				
	70	VC	0.26	33	19.3	15.4	12.9	9.7	7.7	6.4	5.1	3.9	0.88	0.59	0.44	0.35				
	80	VC	0.28	36	21	16.6	13.9	10.4	8.3	6.9	5.5	4.2	0.95	0.63	0.48	0.38				
	90	VC	0.30	38	22	17.8	14.9	11.1	8.9	7.4	5.9	4.5	1.0	0.68	0.51	0.41				
	100	VC	0.32	41	24	19.0	15.8	11.9	9.5	7.9	6.3	4.8	1.1	0.73	0.54	0.44				
TTI110025 (50)	15	UC	0.15	19	11.1	8.9	7.4	5.6	4.5	3.7	3.0	2.2	0.51	0.34	0.26	0.20				
	20	UC	0.18	23	13.4	10.7	8.9	6.7	5.3	4.5	3.6	2.7	0.61	0.41	0.31	0.24				
	30	UC	0.22	28	16.3	13.1	10.9	8.2	6.5	5.4	4.4	3.3	0.75	0.50	0.37	0.30				
	40	XC	0.25	32	18.6	14.9	12.4	9.3	7.4	6.2	5.0	3.7	0.85	0.57	0.43	0.34				
	50	XC	0.28	36	21	16.6	13.9	10.4	8.3	6.9	5.5	4.2	0.95	0.63	0.48	0.38				
	60	XC	0.31	40	23	18.4	15.3	11.5	9.2	7.7	6.1	4.6	1.1	0.70	0.53	0.42				
	70	VC	0.33	42	25	19.6	16.3	12.3	9.8	8.2	6.5	4.9	1.1	0.75	0.56	0.45				
	80	VC	0.35	45	26	21	17.3	13.0	10.4	8.7	6.9	5.2	1.2	0.79	0.60	0.48				
	90	VC	0.38	49	28	23	18.8	14.1	11.3	9.4	7.5	5.6	1.3	0.86	0.65	0.52				
	100	VC	0.40	51	30	24	19.8	14.9	11.9	9.9	7.9	5.9	1.4	0.91	0.68	0.54				
TTI11003 (50)	15	UC	0.18	23	13.4	10.7	8.9	6.7	5.3	4.5	3.6	2.7	0.61	0.41	0.31	0.24				
	20	UC	0.21	27	15.6	12.5	10.4	7.8	6.2	5.2	4.2	3.1	0.71	0.48	0.36	0.29				
	30	UC	0.26	33	19.3	15.4	12.9	9.7	7.7	6.4	5.1	3.9	0.88	0.59	0.44	0.35				
	40	XC	0.30	38	22	17.8	14.9	11.1	8.9	7.4	5.9	4.5	1.0	0.68	0.51	0.41				
	50	XC	0.34	44	25	20	16.8	12.6	10.1	8.4	6.7	5.0	1.2	0.77	0.58	0.46				
	60	XC	0.37	47	27	22	18.3	13.7	11.0	9.2	7.3	5.5	1.3	0.84	0.63	0.50				
	70	VC	0.40	51	30	24	19.8	14.9	11.9	9.9	7.9	5.9	1.4	0.91	0.68	0.54				
	80	VC	0.42	54	31	25	21	15.6	12.5	10.4	8.3	6.2	1.4	0.95	0.71	0.57				
	90	VC	0.45	58	33	27	22	16.7	13.4	11.1	8.9	6.7	1.5	1.0	0.77	0.61				
	100	VC	0.47	60	35	28	23	17.4	14.0	11.6	9.3	7.0	1.6	1.1	0.80	0.64				
TTI11004 (50)	15	UC	0.24	31	17.8	14.3	11.9	8.9	7.1	5.9	4.8	3.6	0.82	0.54	0.41	0.33				
	20	UC	0.28	36	21	16.6	13.9	10.4	8.3	6.9	5.5	4.2	0.95	0.63	0.48	0.38				
	30	UC	0.35	45	26	21	17.3	13.0	10.4	8.7	6.9	5.2	1.2	0.79	0.60	0.48				
	40	XC	0.40	51	30	24	19.8	14.9	11.9	9.9	7.9	5.9	1.4	0.91	0.68	0.54				
	50	XC	0.45	58	33	27	22	16.7	13.4	11.1	8.9	6.7	1.5	1.0	0.77	0.61				
	60	XC	0.49	63	36	29	24	18.2	14.6	12.1	9.7	7.3	1.7	1.1	0.83	0.67				
	70	VC	0.53	68	39	31	26	19.7	15.7	13.1	10.5	7.9	1.8	1.2	0.90	0.72				
	80	VC	0.57	73	42	34	28	21	16.9	14.1	11.3	8.5	1.9	1.3	0.97	0.78				
	90	VC	0.60	77	45	36	30	22	17.8	14.9	11.9	8.9	2.0	1.4	1.0	0.82				
	100	VC	0.63	81	47	37	31	23	18.7	15.6	12.5	9.4	2.1	1.4	1.1	0.86				
TTI11005 (50)	15	UC	0.31	40	23	18.4	15.3	11.5	9.2	7.7	6.1	4.6	1.1	0.70	0.53	0.42				
	20	UC	0.35	45	26	21	17.3	13.0	10.4	8.7	6.9	5.2	1.2	0.79	0.60	0.48				
	30	UC	0.43	55	32	26	21	16.0	12.8	10.6	8.5	6.4	1.5	0.97	0.73	0.58				
	40	XC	0.50	64	37	30	25	18.6	14.9	12.4	9.9	7.4	1.7	1.1	0.85	0.68				
	50	XC	0.56	72	42	33	28	21	16.6	13.9	11.1	8.3	1.9	1.3	0.95	0.76				
	60	XC	0.61	78	45	36	30	23	18.1	15.1	12.1	9.1	2.1	1.4	1.0	0.83				
	70	VC	0.66	84	49	39	33	25	19.6	16.3	13.1	9.8	2.2	1.5	1.1	0.90				
	80	VC	0.71	91	53	42	35	26	21	17.6	14.1	10.5	2.4	1.6	1.2	0.97				
	90	VC	0.75	96	56	45	37	28	22	18.6	14.9	11.1	2.6	1.7	1.3	1.0				
	100	VC	0.79	101	59	47	39	29	23	19.6	15.6	11.7	2.7	1.8	1.3	1.1				
TTI11006 (50)	15	UC	0.37	47	27	22	18.3	13.7	11.0	9.2	7.3	5.5	1.3	0.84	0.63	0.50				
	20	UC	0.42	54	31	25	21	15.6	12.5	10.4	8.3	6.2	1.4	0.95	0.71	0.57				
	30	UC	0.52	67	39	31	26	19.3	15.4	12.9	10.3	7.7	1.8	1.2	0.88	0.71				
	40	XC	0.60	77	45	36	30	22	17.8	14.9	11.9	8.9	2.0	1.4	1.0	0.82				
	50	XC	0.67	86	50	40	33	25	19.9	16.6	13.3	9.9	2.3	1.5	1.1	0.91				
	60	VC	0.73	93	54	43	36	27	22	18.1	14.5	10.8	2.5	1.7	1.2	0.99				
	70	VC	0.79	101	59	47	39	29	23	19.6	15.6	11.7	2.7	1.8	1.3	1.1				
	80	VC	0.85	109	63	50	42	32	27	21	16.8	12.6	2.9							



BROADCAST NOZZLES

## Typical Applications



**HERBICIDE**  
SOIL APPLIED  
**EXCELLENT**  
SYSTEMIC  
**EXCELLENT**



**FERTILIZER**  
BROADCAST  
**EXCELLENT**



**DRIFT CONTROL**  
**EXCELLENT**



**PWM APPROVED**



### FEATURES

- TTI60 produces two 110° wide angle, flat spray patterns for uniform coverage in broadcast applications.
- Extremely large drift resistant droplets are produced through the use of a venturi air aspirator.
- Provides excellent drift control and produces minimal driftable fines—less than 1.5%.\*
- 60° angle between leading and trailing patterns for increased canopy penetration and leaf coverage.
- All in one molded nozzle and Quick TeeJet® cap design provides automatic spray alignment.
- Removable pre-orifice allows for disassembly and cleaning.
- Available in seven VisiFlo® Polymer (VP) capacities.
- Replacement gasket: CP19438-1-EPR

\* -04 capacity spraying water at 40 PSI. Driftable fines defined as droplets smaller than 150 microns.

### SPRAY PATTERN

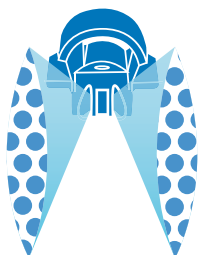

### DROPLET SIZE CLASSIFICATION

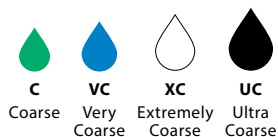

### OPTIMUM SPRAY HEIGHT

<b>ANGLE</b>	<b>HEIGHT</b>
110°	20"

### RECOMMENDED PRESSURE RANGE



### MATERIALS AVAILABLE



### HOW TO ORDER

Polymer with VisiFlo color-coding

**TTI60-11004VP**

Tip Type	Spray Angle	Capacity Size	Material Code





BROADCAST NOZZLES

TIP PART NO. (STRAINER MESH SIZE)	PSI	DROP SIZE	CAPACITY ONE TIP IN GPM	CAPACITY ONE TIP IN OZ/MIN	APPLICATION RATE FOR 20" SPRAY TIP SPACING													
					GALLONS PER ACRE (GPA)								TURF APPLICATION GALLONS PER 1000 SQ. FT.					
					4 MPH	5 MPH	6 MPH	8 MPH	10 MPH	12 MPH	15 MPH	20 MPH	2 MPH	3 MPH	4 MPH	5 MPH		
TTI160-11002VP (50)	20	UC	0.14	18	10.4	8.3	6.9	5.2	4.2	3.5	2.8	2.1	0.48	0.32	0.24	0.19		
	30	XC	0.17	22	12.6	10.1	8.4	6.3	5.0	4.2	3.4	2.5	0.58	0.39	0.29	0.23		
	40	XC	0.20	26	14.9	11.9	9.9	7.4	5.9	5.0	4.0	3.0	0.68	0.45	0.34	0.27		
	50	VC	0.22	28	16.3	13.1	10.9	8.2	6.5	5.4	4.4	3.3	0.75	0.50	0.37	0.30		
	60	VC	0.24	31	17.8	14.3	11.9	8.9	7.1	5.9	4.8	3.6	0.82	0.54	0.41	0.33		
	70	VC	0.26	33	19.3	15.4	12.9	9.7	7.7	6.4	5.1	3.9	0.88	0.59	0.44	0.35		
	80	C	0.28	36	21	16.6	13.9	10.4	8.3	6.9	5.5	4.2	0.95	0.63	0.48	0.38		
	90	C	0.30	38	22	17.8	14.9	11.1	8.9	7.4	5.9	4.5	1.0	0.68	0.51	0.41		
	100	C	0.32	41	24	19.0	15.8	11.9	9.5	7.9	6.3	4.8	1.1	0.73	0.54	0.44		
	TTI160-110025VP (50)	20	UC	0.18	23	13.4	10.7	8.9	6.7	5.3	4.5	3.6	2.7	0.61	0.41	0.31	0.24	
30		XC	0.22	28	16.3	13.1	10.9	8.2	6.5	5.4	4.4	3.3	0.75	0.50	0.37	0.30		
40		XC	0.25	32	18.6	14.9	12.4	9.3	7.4	6.2	5.0	3.7	0.85	0.57	0.43	0.34		
50		VC	0.28	36	21	16.6	13.9	10.4	8.3	6.9	5.5	4.2	0.95	0.63	0.48	0.38		
60		VC	0.31	40	23	18.4	15.3	11.5	9.2	7.7	6.1	4.6	1.1	0.70	0.53	0.42		
70		VC	0.33	42	25	19.6	16.3	12.3	9.8	8.2	6.5	4.9	1.1	0.75	0.56	0.45		
80		C	0.35	45	26	21	17.3	13.0	10.4	8.7	6.9	5.2	1.2	0.79	0.60	0.48		
90		C	0.38	49	28	23	18.8	14.1	11.3	9.4	7.5	5.6	1.3	0.86	0.65	0.52		
100		C	0.40	51	30	24	19.8	14.9	11.9	9.9	7.9	5.9	1.4	0.91	0.68	0.54		
TTI160-11003VP (50)		20	UC	0.21	27	15.6	12.5	10.4	7.8	6.2	5.2	4.2	3.1	0.71	0.48	0.36	0.29	
	30	XC	0.26	33	19.3	15.4	12.9	9.7	7.7	6.4	5.1	3.9	0.88	0.59	0.44	0.35		
	40	XC	0.30	38	22	17.8	14.9	11.1	8.9	7.4	5.9	4.5	1.0	0.68	0.51	0.41		
	50	XC	0.34	44	25	20	16.8	12.6	10.1	8.4	6.7	5.0	1.2	0.77	0.58	0.46		
	60	XC	0.37	47	27	22	18.3	13.7	11.0	9.2	7.3	5.5	1.3	0.84	0.63	0.50		
	70	VC	0.40	51	30	24	19.8	14.9	11.9	9.9	7.9	5.9	1.4	0.91	0.68	0.54		
	80	VC	0.42	54	31	25	21	15.6	12.5	10.4	8.3	6.2	1.4	0.95	0.71	0.57		
	90	VC	0.45	58	33	27	22	16.7	13.4	11.1	8.9	6.7	1.5	1.0	0.77	0.61		
	100	VC	0.47	60	35	28	23	17.4	14.0	11.6	9.3	7.0	1.6	1.1	0.80	0.64		
	TTI160-11004VP (50)	20	UC	0.28	36	21	16.6	13.9	10.4	8.3	6.9	5.5	4.2	0.95	0.63	0.48	0.38	
30		UC	0.35	45	26	21	17.3	13.0	10.4	8.7	6.9	5.2	1.2	0.79	0.60	0.48		
40		XC	0.40	51	30	24	19.8	14.9	11.9	9.9	7.9	5.9	1.4	0.91	0.68	0.54		
50		XC	0.45	58	33	27	22	16.7	13.4	11.1	8.9	6.7	1.5	1.0	0.77	0.61		
60		XC	0.49	63	36	29	24	18.2	14.6	12.1	9.7	7.3	1.7	1.1	0.83	0.67		
70		VC	0.53	68	39	31	26	19.7	15.7	13.1	10.5	7.9	1.8	1.2	0.90	0.72		
80		VC	0.57	73	42	34	28	21	16.9	14.1	11.3	8.5	1.9	1.3	0.97	0.78		
90		VC	0.60	77	45	36	30	22	17.8	14.9	11.9	8.9	2.0	1.4	1.0	0.82		
100		VC	0.63	81	47	37	31	23	18.7	15.6	12.5	9.4	2.1	1.4	1.1	0.86		
TTI160-11005VP (50)		20	UC	0.35	45	26	21	17.3	13.0	10.4	8.7	6.9	5.2	1.2	0.79	0.60	0.48	
	30	UC	0.43	55	32	26	21	16.0	12.8	10.6	8.5	6.4	1.5	0.97	0.73	0.58		
	40	XC	0.50	64	37	30	25	18.6	14.9	12.4	9.9	7.4	1.7	1.1	0.85	0.68		
	50	XC	0.56	72	42	33	28	21	16.6	13.9	11.1	8.3	1.9	1.3	0.95	0.76		
	60	XC	0.61	78	45	36	30	23	18.1	15.1	12.1	9.1	2.1	1.4	1.0	0.83		
	70	VC	0.66	84	49	39	33	25	19.6	16.3	13.1	9.8	2.2	1.5	1.1	0.90		
	80	VC	0.71	91	53	42	35	26	21	17.6	14.1	10.5	2.4	1.6	1.2	0.97		
	90	VC	0.75	96	56	45	37	28	22	18.6	14.9	11.1	2.6	1.7	1.3	1.0		
	100	VC	0.79	101	59	47	39	29	23	19.6	15.6	11.7	2.7	1.8	1.3	1.1		
	TTI160-11006VP (50)	20	UC	0.42	54	31	25	21	15.6	12.5	10.4	8.3	6.2	1.4	0.95	0.71	0.57	
30		UC	0.52	67	39	31	26	19.3	15.4	12.9	10.3	7.7	1.8	1.2	0.88	0.71		
40		XC	0.60	77	45	36	30	22	17.8	14.9	11.9	8.9	2.0	1.4	1.0	0.82		
50		XC	0.67	86	50	40	33	25	19.9	16.6	13.3	9.9	2.3	1.5	1.1	0.91		
60		XC	0.73	93	54	43	36	27	22	18.1	14.5	10.8	2.5	1.7	1.2	0.99		
70		VC	0.79	101	59	47	39	29	23	19.6	15.6	11.7	2.7	1.8	1.3	1.1		
80		VC	0.85	109	63	50	42	32	25	21	16.8	12.6	2.9	1.9	1.4	1.2		
90		VC	0.90	115	67	53	45	33	27	22	17.8	13.4	3.1	2.0	1.5	1.2		
100		VC	0.95	122	71	56	47	35	28	24	18.8	14.1	3.2	2.2	1.6	1.3		
TTI160-11008VP (50)		20	UC	0.57	73	42	34	28	21	16.9	14.1	11.3	8.5	1.9	1.3	0.97	0.78	
	30	UC	0.69	88	51	41	34	26	20	17.1	13.7	10.2	2.3	1.6	1.2	0.94		
	40	XC	0.80	102	59	48	40	30	24	19.8	15.8	11.9	2.7	1.8	1.4	1.09		
	50	XC	0.89	114	66	53	44	33	26	22	17.6	13.2	3.0	2.0	1.5	1.2		
	60	XC	0.98	125	73	58	49	36	29	24	19.4	14.6	3.3	2.2	1.7	1.3		
	70	VC	1.06	136	79	63	52	39	31	26	21	15.7	3.6	2.4	1.8	1.4		
	80	VC	1.13	145	84	67	56	42	34	28	22	16.8	3.8	2.6	1.9	1.5		
	90	VC	1.20	154	89	71	59	45	36	30	24	17.8	4.1	2.7	2.0	1.6		
	100	VC	1.26	161	94	75	62	47	37	31	25	18.7	4.3	2.9	2.1	1.7		

**Note:** Always double check your application rates. Droplet size classification shown is based on ISO 25358. Droplet size classification standard is subject to change. Tabulations are based on spraying water at 70°F. See technical information (pages 179–202) for droplet size classification, useful formulas and other technical information.



BROADCAST NOZZLES

### Typical Applications



**HERBICIDE**  
CONTACT  
**VERY GOOD**  
SYSTEMIC  
**GOOD**



**FUNGICIDE**  
CONTACT  
**EXCELLENT**  
SYSTEMIC  
**GOOD**



**INSECTICIDE**  
CONTACT  
**EXCELLENT**  
SYSTEMIC  
**GOOD**



**DRIFT CONTROL**  
**GOOD**



**PWM APPROVED**

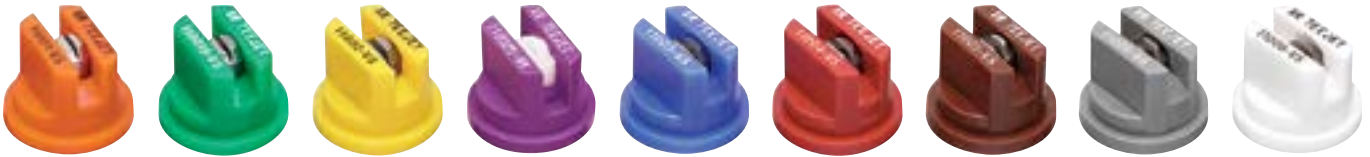

### FEATURES

- Tapered edge flat spray angle pattern for uniform coverage in broadcast spray application.
- Reduces drift at lower pressures, better coverage at higher pressures.
- Ceramic is available with corrosive resistant polypropylene VisiFlo color-coded tip holder in 80° capacities 03-08 and 110° capacities 02-08.
- XR110025 only available in VK.
- XR80025 and XR80035 only available in VS.
- Brass available in 110° only.
- Automatic spray alignment with 114441A-\*-CELR (01 to 08) or 114443A-\*-CELR (10 and 15) Quick TeeJet® cap and gasket. Reference page 118 for more information.

### SPRAY PATTERN

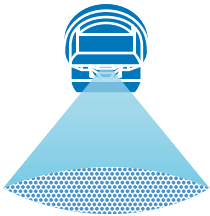

### DROPLET SIZE CLASSIFICATION

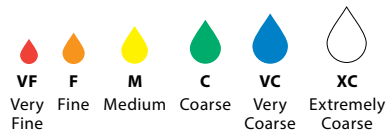

### OPTIMUM SPRAY HEIGHT

ANGLE	HEIGHT
80°	30"
110°	20"

### RECOMMENDED PRESSURE RANGE



### MATERIALS AVAILABLE

- VS** STAINLESS STEEL
- VP** POLYMER
- VK** CERAMIC
- VB** BRASS
- SS** STAINLESS STEEL

### HOW TO ORDER

Ceramic with VisiFlo® color-coding

**X R 1 1 0 0 4 - V K**

Tip Type   Spray Angle   Capacity Size   Material Code

Polymer with VisiFlo color-coding, includes Quick TeeJet cap and gasket\*

**X R 1 1 0 0 2 - V P - C E**

Tip Type   Spray Angle   Capacity Size   Material Code   Cap and Gasket Included

\*Reference page 118 for more caps information.



BROADCAST NOZZLES

TIP PART NO. (STRAINER MESH SIZE)	PSI	DROP SIZE		CAPACITY ONE TIP IN GPM	CAPACITY ONE TIP IN OZ/MIN	APPLICATION RATE FOR 20" SPRAY TIP SPACING												
		80°	110°			GALLONS PER ACRE (GPA)								TURF APPLICATION GALLONS PER 1000 SQ. FT.				
						4 MPH	5 MPH	6 MPH	8 MPH	10 MPH	12 MPH	15 MPH	20 MPH	2 MPH	3 MPH	4 MPH	5 MPH	
XR8001 XR11001 (100)	15	F	F	0.061	7.8	4.5	3.6	3.0	2.3	1.8	1.5	1.2	0.91	0.21	0.14	0.10	0.08	
	20	F	F	0.071	9.1	5.3	4.2	3.5	2.6	2.1	1.8	1.4	1.1	0.24	0.16	0.12	0.10	
	30	F	F	0.087	11	6.5	5.2	4.3	3.2	2.6	2.2	1.7	1.3	0.30	0.20	0.15	0.12	
	40	F	F	0.10	13	7.4	5.9	5.0	3.7	3.0	2.5	2.0	1.5	0.34	0.23	0.17	0.14	
	50	F	F	0.11	14	8.2	6.5	5.4	4.1	3.3	2.7	2.2	1.6	0.37	0.25	0.19	0.15	
XR80015 XR110015 (100)	15	M	M	0.092	12	6.8	5.5	4.6	3.4	2.7	2.3	1.8	1.4	0.31	0.21	0.16	0.13	
	20	F	F	0.11	14	8.2	6.5	5.4	4.1	3.3	2.7	2.2	1.6	0.37	0.25	0.19	0.15	
	30	F	F	0.13	17	9.7	7.7	6.4	4.8	3.9	3.2	2.6	1.9	0.44	0.29	0.22	0.18	
	40	F	F	0.15	19	11.1	8.9	7.4	5.6	4.5	3.7	3.0	2.2	0.51	0.34	0.26	0.20	
	50	F	F	0.17	22	12.6	10.1	8.4	6.3	5.0	4.2	3.4	2.5	0.58	0.39	0.29	0.23	
XR8002 XR11002 (50)	15	M	M	0.12	15	8.9	7.1	5.9	4.5	3.6	3.0	2.4	1.8	0.41	0.27	0.20	0.16	
	20	M	M	0.14	18	10.4	8.3	6.9	5.2	4.2	3.5	2.8	2.1	0.48	0.32	0.24	0.19	
	30	F	F	0.17	22	12.6	10.1	8.4	6.3	5.0	4.2	3.4	2.5	0.58	0.39	0.29	0.23	
	40	F	F	0.20	26	14.9	11.9	9.9	7.4	5.9	5.0	4.0	3.0	0.68	0.45	0.34	0.27	
	50	F	F	0.22	28	16.3	13.1	10.9	8.2	6.5	5.4	4.4	3.3	0.75	0.50	0.37	0.30	
XR80025 XR110025 (50)	15	M	M	0.15	19	11.1	8.9	7.4	5.6	4.5	3.7	3.0	2.2	0.51	0.34	0.26	0.20	
	20	M	M	0.18	23	13.4	10.7	8.9	6.7	5.3	4.5	3.6	2.7	0.61	0.41	0.31	0.24	
	30	M	M	0.22	28	16.3	13.1	10.9	8.2	6.5	5.4	4.4	3.3	0.75	0.50	0.37	0.30	
	40	F	F	0.25	32	18.6	14.9	12.4	9.3	7.4	6.2	5.0	3.7	0.85	0.57	0.43	0.34	
	50	F	F	0.28	36	21	16.6	13.9	10.4	8.3	6.9	5.5	4.2	0.95	0.63	0.48	0.38	
XR8003 XR11003 (50)	15	M	M	0.18	23	13.4	10.7	8.9	6.7	5.3	4.5	3.6	2.7	0.61	0.41	0.31	0.24	
	20	M	M	0.21	27	15.6	12.5	10.4	7.8	6.2	5.2	4.2	3.1	0.71	0.48	0.36	0.29	
	30	M	M	0.26	33	19.3	15.4	12.9	9.7	7.7	6.4	5.1	3.9	0.88	0.59	0.44	0.35	
	40	F	F	0.30	38	22	17.8	14.9	11.1	8.9	7.4	5.9	4.5	1.0	0.68	0.51	0.41	
	50	F	F	0.34	44	25	20	16.8	12.6	10.1	8.4	6.7	5.0	1.2	0.77	0.58	0.46	
XR80035 (50)	15	M		0.21	27	15.6	12.5	10.4	7.8	6.2	5.2	4.2	3.1	0.71	0.48	0.36	0.29	
	20	M		0.25	32	18.6	14.9	12.4	9.3	7.4	6.2	5.0	3.7	0.85	0.57	0.43	0.34	
	30	M		0.30	38	22	17.8	14.9	11.1	8.9	7.4	5.9	4.5	1.0	0.68	0.51	0.41	
	40	M		0.35	45	26	21	17.3	13.0	10.4	8.7	6.9	5.2	1.2	0.79	0.60	0.48	
	50	F		0.39	50	29	23	19.3	14.5	11.6	9.7	7.7	5.8	1.3	0.88	0.66	0.53	
XR8004 XR11004 (50)	15	M	M	0.24	31	17.8	14.3	11.9	8.9	7.1	5.9	4.8	3.6	0.82	0.54	0.41	0.33	
	20	M	M	0.28	36	21	16.6	13.9	10.4	8.3	6.9	5.5	4.2	1.0	0.63	0.48	0.38	
	30	M	M	0.35	45	26	21	17.3	13.0	10.4	8.7	6.9	5.2	1.2	0.79	0.60	0.48	
	40	M	M	0.40	51	30	24	19.8	14.9	11.9	9.9	7.9	5.9	1.4	0.91	0.68	0.54	
	50	F	F	0.45	58	33	27	22	16.7	13.4	11.1	8.9	6.7	1.5	1.0	0.77	0.61	
XR8005 XR11005 (50)	15	C	M	0.31	40	23	18.4	15.3	11.5	9.2	7.7	6.1	4.6	1.1	0.70	0.53	0.42	
	20	M	M	0.35	45	26	21	17.3	13.0	10.4	8.7	6.9	5.2	1.2	0.79	0.60	0.48	
	30	M	M	0.43	55	32	26	21	16.0	12.8	10.6	8.5	6.4	1.5	0.97	0.73	0.58	
	40	M	M	0.50	64	37	30	25	18.6	14.9	12.4	9.9	7.4	1.7	1.1	0.85	0.68	
	50	M	F	0.56	72	42	33	28	21	16.6	13.9	11.1	8.3	1.9	1.3	0.95	0.76	
XR8006 XR11006 (50)	15	C	C	0.37	47	27	22	18.3	13.7	11.0	9.2	7.3	5.5	1.3	0.84	0.63	0.50	
	20	C	M	0.42	54	31	25	21	15.6	12.5	10.4	8.3	6.2	1.4	0.95	0.71	0.57	
	30	M	M	0.52	67	39	31	26	19.3	15.4	12.9	10.3	7.7	1.8	1.2	0.88	0.71	
	40	M	M	0.60	77	45	36	30	22	17.8	14.9	11.9	8.9	2.0	1.4	1.0	0.82	
	50	M	M	0.67	86	50	40	33	25	19.9	16.6	13.3	9.9	2.3	1.5	1.1	0.91	
XR8008 XR11008 (50)	15	VC	C	0.49	63	36	29	24	18.2	14.6	12.1	9.7	7.3	1.7	1.1	0.83	0.67	
	20	C	M	0.57	73	42	34	28	21	16.9	14.1	11.3	8.5	1.9	1.3	0.97	0.78	
	30	C	M	0.69	88	51	41	34	26	20	17.1	13.7	10.2	2.3	1.6	1.2	0.94	
	40	M	M	0.80	102	59	48	40	30	24	19.8	15.8	11.9	2.7	1.8	1.4	1.1	
	50	M	M	0.89	114	66	53	44	33	26	22	17.6	13.2	3.0	2.0	1.5	1.2	
XR8010† XR11010†	15	VC	C	0.61	78	45	36	30	23	18.1	15.1	12.1	9.1	2.1	1.4	1.0	0.83	
	20	C	C	0.71	91	53	42	35	26	21	17.6	14.1	10.5	2.4	1.6	1.2	0.97	
	30	C	C	0.87	111	65	52	43	32	26	22	17.2	12.9	3.0	2.0	1.5	1.2	
	40	M	M	1.00	128	74	59	50	37	30	25	19.8	14.9	3.4	2.3	1.7	1.4	
	50	M	M	1.12	143	83	67	55	42	33	28	22	16.6	3.8	2.5	1.9	1.5	
XR8015† XR11015†	15	XC	VC	0.92	118	68	55	46	34	27	23	18.2	13.7	3.1	2.1	1.6	1.3	
	20	VC	VC	1.06	136	79	63	52	39	31	26	21	15.7	3.6	2.4	1.8	1.4	
	30	VC	C	1.30	166	97	77	64	48	39	32	26	19.3	4.4	2.9	2.2	1.8	
	40	C	C	1.50	192	111	89	74	56	45	37	30	22	5.1	3.4	2.6	2.0	
	50	C	C	1.68	215	125	100	83	62	50	42	33	25	5.7	3.8	2.9	2.3	
60	C	M	1.84	236	137	109	91	68	55	46	36	27	6.3	4.2	3.1	2.5		

**Note:** Always double check your application rates. Droplet size classification shown is based on ISO 25358. Droplet size classification standard is subject to change. Tabulations are based on spraying water at 70°F. See technical information (pages 179–202) for droplet size classification, useful formulas and other technical information. †Available in all stainless steel only.





BROADCAST NOZZLES

## Typical Applications



**HERBICIDE**  
CONTACT  
**VERY GOOD**  
SYSTEMIC  
**GOOD**



**FUNGICIDE**  
CONTACT  
**EXCELLENT**  
SYSTEMIC  
**GOOD**



**INSECTICIDE**  
CONTACT  
**EXCELLENT**  
SYSTEMIC  
**GOOD**



**DRIFT CONTROL**  
**GOOD**



**PWM APPROVED**



## FEATURES

- Tapered edge flat spray pattern for uniform coverage in broadcast spraying.
- Reduces drift at lower pressures, improves coverage at higher pressures.
- Various XR orifice materials are permanently assembled into reinforced nylon Quick TeeJet caps, providing reliable XR performance, convenient installation, and automatic pattern alignment.
- Includes tightly fitting gasket that stays put and assures a good seal. Replacement gasket part number: CP19438-1-EPR

## SPRAY PATTERN

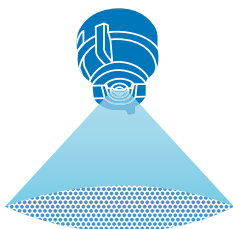

## DROPLET SIZE CLASSIFICATION

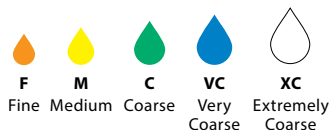

## OPTIMUM SPRAY HEIGHT

ANGLE	HEIGHT
80°	30"
110°	20"

## RECOMMENDED PRESSURE RANGE



## MATERIALS AVAILABLE

- VS** STAINLESS STEEL
- VP** POLYMER
- VK** CERAMIC

## HOW TO ORDER

Stainless Steel with VisiFlo® color-coding

**X R C 1 1 0 0 4 - V S**

Tip Type    Spray Angle    Capacity Size    Material Code

Polymer with VisiFlo color-coding

**X R C 1 1 0 0 4 - V P**

Tip Type    Spray Angle    Capacity Size    Material Code

Ceramic with VisiFlo color-coding

**X R C 1 1 0 0 4 - V K**

Tip Type    Spray Angle    Capacity Size    Material Code



BROADCAST NOZZLES

TIP PART NO. (STRAINER MESH SIZE)	PSI	DROP SIZE		CAPACITY ONE TIP IN GPM	CAPACITY ONE TIP IN OZ/MIN	APPLICATION RATE FOR 20" SPRAY TIP SPACING											
		80°	110°			GALLONS PER ACRE (GPA)								TURF APPLICATION GALLONS PER 1000 SQ. FT.			
						4 MPH	5 MPH	6 MPH	8 MPH	10 MPH	12 MPH	15 MPH	20 MPH	2 MPH	3 MPH	4 MPH	5 MPH
XRC80015 (100)	15	M	M	0.092	12	6.8	5.5	4.6	3.4	2.7	2.3	1.8	1.4	0.31	0.21	0.16	0.13
	20	F	F	0.11	14	8.2	6.5	5.4	4.1	3.3	2.7	2.2	1.6	0.37	0.25	0.19	0.15
	30	F	F	0.13	17	9.7	7.7	6.4	4.8	3.9	3.2	2.6	1.9	0.44	0.29	0.22	0.18
	40	F	F	0.15	19	11.1	8.9	7.4	5.6	4.5	3.7	3.0	2.2	0.51	0.34	0.26	0.20
	50	F	F	0.17	22	12.6	10.1	8.4	6.3	5.0	4.2	3.4	2.5	0.58	0.39	0.29	0.23
XRC8002 XRC11002 (50)	15	M	M	0.12	15	8.9	7.1	5.9	4.5	3.6	3.0	2.4	1.8	0.41	0.27	0.20	0.16
	20	M	M	0.14	18	10.4	8.3	6.9	5.2	4.2	3.5	2.8	2.1	0.48	0.32	0.24	0.19
	30	F	F	0.17	22	12.6	10.1	8.4	6.3	5.0	4.2	3.4	2.5	0.58	0.39	0.29	0.23
	40	F	F	0.20	26	14.9	11.9	9.9	7.4	5.9	5.0	4.0	3.0	0.68	0.45	0.34	0.27
	50	F	F	0.22	28	16.3	13.1	10.9	8.2	6.5	5.4	4.4	3.3	0.75	0.50	0.37	0.30
XRC110025 (50)	15	M	M	0.15	19	11.1	8.9	7.4	5.6	4.5	3.7	3.0	2.2	0.51	0.34	0.26	0.20
	20	M	M	0.18	23	13.4	10.7	8.9	6.7	5.3	4.5	3.6	2.7	0.61	0.41	0.31	0.24
	30	M	M	0.22	28	16.3	13.1	10.9	8.2	6.5	5.4	4.4	3.3	0.75	0.50	0.37	0.30
	40	F	F	0.25	32	18.6	14.9	12.4	9.3	7.4	6.2	5.0	3.7	0.85	0.57	0.43	0.34
	50	F	F	0.28	36	21	16.6	13.9	10.4	8.3	6.9	5.5	4.2	0.95	0.63	0.48	0.38
XRC8003 XRC11003 (50)	15	M	M	0.18	23	13.4	10.7	8.9	6.7	5.3	4.5	3.6	2.7	0.61	0.41	0.31	0.24
	20	M	M	0.21	27	15.6	12.5	10.4	7.8	6.2	5.2	4.2	3.1	0.71	0.48	0.36	0.29
	30	M	M	0.26	33	19.3	15.4	12.9	9.7	7.7	6.4	5.1	3.9	0.88	0.59	0.44	0.35
	40	F	F	0.30	38	22	17.8	14.9	11.1	8.9	7.4	5.9	4.5	1.0	0.68	0.51	0.41
	50	F	F	0.34	44	25	20	16.8	12.6	10.1	8.4	6.7	5.0	1.2	0.77	0.58	0.46
XRC8004 XRC11004 (50)	15	M	M	0.24	31	17.8	14.3	11.9	8.9	7.1	5.9	4.8	3.6	0.82	0.54	0.41	0.33
	20	M	M	0.28	36	21	16.6	13.9	10.4	8.3	6.9	5.5	4.2	0.95	0.63	0.48	0.38
	30	M	M	0.35	45	26	21	17.3	13.0	10.4	8.7	6.9	5.2	1.2	0.79	0.60	0.48
	40	M	M	0.40	51	30	24	19.8	14.9	11.9	9.9	7.9	5.9	1.4	0.91	0.68	0.54
	50	F	F	0.45	58	33	27	22	16.7	13.4	11.1	8.9	6.7	1.5	1.0	0.77	0.61
XRC8005 XRC11005 (50)	15	C	M	0.31	40	23	18.4	15.3	11.5	9.2	7.7	6.1	4.6	1.1	0.70	0.53	0.42
	20	M	M	0.35	45	26	21	17.3	13.0	10.4	8.7	6.9	5.2	1.2	0.79	0.60	0.48
	30	M	M	0.43	55	32	26	21	16.0	12.8	10.6	8.5	6.4	1.5	0.97	0.73	0.58
	40	M	M	0.50	64	37	30	25	18.6	14.9	12.4	9.9	7.4	1.7	1.1	0.85	0.68
	50	M	F	0.56	72	42	33	28	21	16.6	13.9	11.1	8.3	1.9	1.3	0.95	0.76
XRC8006 XRC11006 (50)	15	C	C	0.37	47	27	22	18.3	13.7	11.0	9.2	7.3	5.5	1.3	0.84	0.63	0.50
	20	C	M	0.42	54	31	25	21	15.6	12.5	10.4	8.3	6.2	1.4	0.95	0.71	0.57
	30	M	M	0.52	67	39	31	26	19.3	15.4	12.9	10.3	7.7	1.8	1.2	0.88	0.71
	40	M	M	0.60	77	45	36	30	22	17.8	14.9	11.9	8.9	2.0	1.4	1.0	0.82
	50	M	M	0.67	86	50	40	33	25	19.9	16.6	13.3	9.9	2.3	1.5	1.1	0.91
XRC8008 XRC11008 (50)	15	VC	C	0.49	63	36	29	24	18.2	14.6	12.1	9.7	7.3	1.7	1.1	0.83	0.67
	20	C	M	0.57	73	42	34	28	21	16.9	14.1	11.3	8.5	1.9	1.3	0.97	0.78
	30	C	M	0.69	88	51	41	34	26	20	17.1	13.7	10.2	2.3	1.6	1.2	0.94
	40	M	M	0.80	102	59	48	40	30	24	19.8	15.8	11.9	2.7	1.8	1.4	1.1
	50	M	M	0.89	114	66	53	44	33	26	22	17.6	13.2	3.0	2.0	1.5	1.2
XRC11010	15	VC	C	0.61	78	45	36	30	23	18.1	15.1	12.1	9.1	2.1	1.4	1.0	0.83
	20	C	C	0.71	91	53	42	35	26	21	17.6	14.1	10.5	2.4	1.6	1.2	0.97
	30	C	C	0.87	111	65	52	43	32	26	22	17.2	12.9	3.0	2.0	1.5	1.2
	40	M	M	1.00	128	74	59	50	37	30	25	19.8	14.9	3.4	2.3	1.7	1.4
	50	M	M	1.12	143	83	67	55	42	33	28	22	16.6	3.8	2.5	1.9	1.5
XRC11015	15	XC	VC	0.92	118	68	55	46	34	27	23	18.2	13.7	3.1	2.1	1.6	1.3
	20	VC	VC	1.06	136	79	63	52	39	31	26	21	15.7	3.6	2.4	1.8	1.4
	30	VC	C	1.30	166	97	77	64	48	39	32	26	19.3	4.4	2.9	2.2	1.8
	40	C	C	1.50	192	111	89	74	56	45	37	30	22	5.1	3.4	2.6	2.0
	50	C	C	1.68	215	125	100	83	62	50	42	33	25	5.7	3.8	2.9	2.3
XRC11020	15		XC	1.22	156	91	72	60	45	36	30	24	18.1	4.1	2.8	2.1	1.7
	20		VC	1.41	180	105	84	70	52	42	35	28	21	4.8	3.2	2.4	1.9
	30		VC	1.73	221	128	103	86	64	51	43	34	26	5.9	3.9	2.9	2.4
	40		C	2.00	256	149	119	99	74	59	50	40	30	6.8	4.5	3.4	2.7
	50		C	2.24	287	166	133	111	83	67	55	44	33	7.6	5.1	3.8	3.0
60		C	2.45	314	182	146	121	91	73	61	49	36	8.3	5.6	4.2	3.3	

**Note:** Always double check your application rates. Droplet size classification shown is based on ISO 25358. Droplet size classification standard is subject to change. Tabulations are based on spraying water at 70°F. See technical information (pages 179–202) for droplet size classification, useful formulas and other technical information.



## Typical Applications

<b>HERBICIDE</b>	<b>FUNGICIDE</b>	<b>INSECTICIDE</b>	<b>FERTILIZER</b>	<b>DRIFT CONTROL</b>	<b>PWM APPROVED</b>	
SOIL APPLIED	CONTACT	CONTACT	BROADCAST			
<b>EXCELLENT</b>	<b>EXCELLENT</b>	<b>EXCELLENT</b>	<b>EXCELLENT</b>	<b>GOOD</b>		
CONTACT	SYSTEMIC	SYSTEMIC				
<b>VERY GOOD</b>	<b>GOOD</b>	<b>GOOD</b>				
SYSTEMIC						
<b>GOOD</b>						

## FEATURES

- Tapered edge flat spray pattern for uniform coverage in broadcast spraying.
- VisiFlo® color-coded version available in stainless steel, ceramic and polymer in 80° or 110° spray angles in selected sizes.
- Available in ceramic 80° capacities 01–02 and 110° capacities 01–015. See XR and XRC TeeJet® tips on pages 28–31 for larger capacities.
- See pages 68–69 for TeeJet even flat spray tips.
- Automatic spray alignment with 114441A-\*–CELR (0065 to 08) or 114443A-\*–CELR (10 to 20) Quick TeeJet® cap and gasket. Reference page 118 for more information.

## SPRAY PATTERN

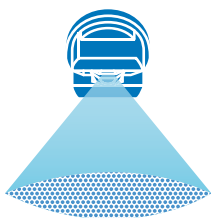

## DROPLET SIZE CLASSIFICATION

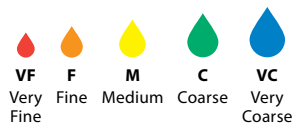

## OPTIMUM SPRAY HEIGHT

ANGLE	20" SPACING HEIGHT
65°	35"
80°	30"
110°	20"

## MATERIALS AVAILABLE

- VS** STAINLESS STEEL
- VP** POLYMER
- HSS** HARDENED STAINLESS STEEL
- B** BRASS

## RECOMMENDED PRESSURE RANGE



## HOW TO ORDER

Stainless Steel with VisiFlo color-coding

T P 8 0 0 2 V S  
 Tip Spray Capacity Material  
 Type Angle Size Code

Polymer with VisiFlo color-coding

T P 1 1 0 0 2 V P  
 Tip Spray Capacity Material  
 Type Angle Size Code

Brass

T P 1 1 0 0 3  
 Tip Spray Capacity  
 Type Angle Size





BROADCAST NOZZLES

TIP PART NO. (STRAINER MESH SIZE)	PSI	DROP SIZE		CAPACITY ONE TIP IN GPM	CAPACITY ONE TIP IN OZ/MIN	APPLICATION RATE FOR 20" SPRAY TIP SPACING											
		80°	110°			GALLONS PER ACRE (GPA)								TURF APPLICATION GALLONS PER 1000 SQ. FT.			
						4 MPH	5 MPH	6 MPH	8 MPH	10 MPH	12 MPH	15 MPH	20 MPH	2 MPH	3 MPH	4 MPH	5 MPH
TP650050† TP800050† TP1100050† (100)	30	F	VF	0.043	5.5	3.2	2.6	2.1	1.6	1.3	1.1	0.85	0.64	0.15	0.10	0.07	0.06
	35	F	VF	0.047	6.0	3.5	2.8	2.3	1.7	1.4	1.2	0.93	0.70	0.16	0.11	0.08	0.06
	40	F	VF	0.050	6.4	3.7	3.0	2.5	1.9	1.5	1.2	0.99	0.74	0.17	0.11	0.09	0.07
	50	VF	VF	0.056	7.2	4.2	3.3	2.8	2.1	1.7	1.4	1.1	0.83	0.19	0.13	0.10	0.08
TP650067† TP800067† TP1100067† (100)	30	F	F	0.058	7.4	4.3	3.4	2.9	2.2	1.7	1.4	1.1	0.86	0.20	0.13	0.10	0.08
	35	F	VF	0.063	8.1	4.7	3.7	3.1	2.3	1.9	1.6	1.2	0.94	0.21	0.14	0.11	0.09
	40	F	VF	0.067	8.6	5.0	4.0	3.3	2.5	2.0	1.7	1.3	0.99	0.23	0.15	0.11	0.09
	50	VF	VF	0.075	9.6	5.6	4.5	3.7	2.8	2.2	1.9	1.5	1.1	0.26	0.17	0.13	0.10
TP6501†	30	F	F	0.087	11	6.5	5.2	4.3	3.2	2.6	2.2	1.7	1.3	0.30	0.20	0.15	0.12
	35	F	F	0.094	12	7.0	5.6	4.7	3.5	2.8	2.3	1.9	1.4	0.32	0.21	0.16	0.13
	40	F	F	0.10	13	7.4	5.9	5.0	3.7	3.0	2.5	2.0	1.5	0.34	0.23	0.17	0.14
	50	F	VF	0.11	14	8.2	6.5	5.4	4.1	3.3	2.7	2.2	1.6	0.37	0.25	0.19	0.15
TP65015†	30	F	F	0.13	17	9.7	7.7	6.4	4.8	3.9	3.2	2.6	1.9	0.44	0.29	0.22	0.18
	35	F	F	0.14	18	10.4	8.3	6.9	5.2	4.2	3.5	2.8	2.1	0.48	0.32	0.24	0.19
	40	F	F	0.15	19	11.1	8.9	7.4	5.6	4.5	3.7	3.0	2.2	0.51	0.34	0.26	0.20
	50	F	F	0.17	22	12.6	10.1	8.4	6.3	5.0	4.2	3.4	2.5	0.58	0.39	0.29	0.23
TP6502†	30	M	F	0.17	22	12.6	10.1	8.4	6.3	5.0	4.2	3.4	2.5	0.58	0.39	0.29	0.23
	35	F	F	0.19	24	14.1	11.3	9.4	7.1	5.6	4.7	3.8	2.8	0.65	0.43	0.32	0.26
	40	F	F	0.20	26	14.9	11.9	9.9	7.4	5.9	5.0	4.0	3.0	0.68	0.45	0.34	0.27
	50	F	F	0.22	28	16.3	13.1	10.9	8.2	6.5	5.4	4.4	3.3	0.75	0.50	0.37	0.30
TP6503†	30	M	M	0.26	33	19.3	15.4	12.9	9.7	7.7	6.4	5.1	3.9	0.88	0.59	0.44	0.35
	35	M	F	0.28	36	21	16.6	13.9	10.4	8.3	6.9	5.5	4.2	0.95	0.63	0.48	0.38
	40	M	F	0.30	38	22	17.8	14.9	11.1	8.9	7.4	5.9	4.5	1.0	0.68	0.51	0.41
	50	F	F	0.34	44	25	20	16.8	12.6	10.1	8.4	6.7	5.0	1.2	0.77	0.58	0.46
TP6504†	30	M	M	0.35	45	26	21	17.3	13.0	10.4	8.7	6.9	5.2	1.2	0.79	0.60	0.48
	35	M	M	0.37	47	27	22	18.3	13.7	11.0	9.2	7.3	5.5	1.3	0.84	0.63	0.50
	40	M	F	0.40	51	30	24	19.8	14.9	11.9	9.9	7.9	5.9	1.4	0.91	0.68	0.54
	50	M	F	0.45	58	33	27	22	16.7	13.4	11.1	8.9	6.7	1.5	1.0	0.77	0.61
TP6505†	30	M	M	0.43	55	32	26	21	16.0	12.8	10.6	8.5	6.4	1.5	0.97	0.73	0.58
	35	M	M	0.47	60	35	28	23	17.4	14.0	11.6	9.3	7.0	1.6	1.1	0.80	0.64
	40	M	M	0.50	64	37	30	25	18.6	14.9	12.4	9.9	7.4	1.7	1.1	0.85	0.68
	50	M	M	0.56	72	42	33	28	21	16.6	13.9	11.1	8.3	1.9	1.3	0.95	0.76
TP6506†	30	C	M	0.52	67	39	31	26	19.3	15.4	12.9	10.3	7.7	1.8	1.2	0.88	0.71
	35	C	M	0.56	72	42	33	28	21	16.6	13.9	11.1	8.3	1.9	1.3	0.95	0.76
	40	M	M	0.60	77	45	36	30	22	17.8	14.9	11.9	8.9	2.0	1.4	1.0	0.82
	50	M	M	0.67	86	50	40	33	25	19.9	16.6	13.3	9.9	2.3	1.5	1.1	0.91
TP6508†	30	C	M	0.69	88	51	41	34	26	20	17.1	13.7	10.2	2.3	1.6	1.2	0.94
	35	C	M	0.75	96	56	45	37	28	22	18.6	14.9	11.1	2.6	1.7	1.3	1.0
	40	C	M	0.80	102	59	48	40	30	24	19.8	15.8	11.9	2.7	1.8	1.4	1.1
	50	M	M	0.89	114	66	53	44	33	26	22	17.6	13.2	3.0	2.0	1.5	1.2
TP6510† TP8010† TP11010†	30	C	M	0.87	111	65	52	43	32	26	22	17.2	12.9	3.0	2.0	1.5	1.2
	35	C	M	0.94	120	70	56	47	35	28	23	18.6	14.0	3.2	2.1	1.6	1.3
	40	C	M	1.00	128	74	59	50	37	30	25	19.8	14.9	3.4	2.3	1.7	1.4
	50	M	M	1.12	143	83	67	55	42	33	28	22	16.6	3.8	2.5	1.9	1.5
TP6515† TP8015† TP11015†	30	VC	C	1.30	166	97	77	64	48	39	32	26	19.3	4.4	2.9	2.2	1.8
	35	C	C	1.40	179	104	83	69	52	42	35	28	21	4.8	3.2	2.4	1.9
	40	C	C	1.50	192	111	89	74	56	45	37	30	22	5.1	3.4	2.6	2.0
	50	C	M	1.68	215	125	100	83	62	50	42	33	25	5.7	3.8	2.9	2.3
TP6520† TP8020† TP11020†	30	VC	VC	1.73	221	128	103	86	64	51	43	34	26	5.9	3.9	2.9	2.4
	35	C	VC	1.87	239	139	111	93	69	56	46	37	28	6.4	4.2	3.2	2.5
	40	C	C	2.00	256	149	119	99	74	59	50	40	30	6.8	4.5	3.4	2.7
	50	C	C	2.24	287	166	133	111	83	67	55	44	33	7.6	5.1	3.8	3.0
60	C	C	2.45	314	182	146	121	91	73	61	49	36	8.3	5.6	4.2	3.3	

**Note:** Always double check your application rates. Droplet size classification shown is based on ISO 25358. Droplet size classification standard is subject to change. Tabulations are based on spraying water at 70°F. See technical information (pages 179–202) for droplet size classification, useful formulas and other technical information.

†Available in brass and/or stainless steel and/or hardened stainless steel.



BROADCAST NOZZLES

## Typical Applications



**HERBICIDE**  
SOIL APPLIED  
**VERY GOOD**  
CONTACT  
**EXCELLENT**  
SYSTEMIC  
**EXCELLENT**



**FUNGICIDE**  
SYSTEMIC  
**EXCELLENT**



**INSECTICIDE**  
SYSTEMIC  
**EXCELLENT**



**FERTILIZER**  
BROADCAST  
**EXCELLENT**



**DRIFT CONTROL**  
**GOOD**



**PWM APPROVED**



## FEATURES

- Pre-orifice design produces larger droplets and reduces the small drift-prone droplets, minimizing off-target spray contamination.
- Tapered edge flat spray pattern provides uniform coverage when adjacent nozzle patterns are overlapped in broadcast spraying.
- The color-coded pre-orifice is removable for any necessary cleaning operations.
- Available in five Visiflo® Stainless Steel (VS) and Visiflo Polymer (VP) capacities.
- Automatic spray alignment with 114441A-\* -CELR Quick TeeJet® cap and gasket. Reference page 118 for more information.

## SPRAY PATTERN

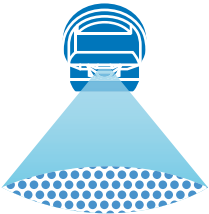

## DROPLET SIZE CLASSIFICATION

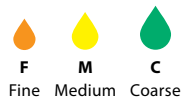

## OPTIMUM SPRAY HEIGHT

20" SPACING	
ANGLE	HEIGHT
80°	30"
110°	20"

## RECOMMENDED PRESSURE RANGE



## MATERIALS AVAILABLE

- VS** STAINLESS STEEL
- VP** POLYMER

## HOW TO ORDER

Stainless Steel with VisiFlo color-coding  
**D G 8 0 0 2 V S**

Tip Type   Spray Angle   Capacity Size   Material Code

Polymer with VisiFlo color-coding  
**D G 1 1 0 0 2 - V P**

Tip Type   Spray Angle   Capacity Size   Material Code



BROADCAST NOZZLES

TIP PART NO. (STRAINER MESH SIZE)	PSI	DROP SIZE		CAPACITY ONE TIP IN GPM	CAPACITY ONE TIP IN OZ/MIN	APPLICATION RATE FOR 20" SPRAY TIP SPACING											
		80°	110°			GALLONS PER ACRE (GPA)								TURF APPLICATION GALLONS PER 1000 SQ. FT.			
						4 MPH	5 MPH	6 MPH	8 MPH	10 MPH	12 MPH	15 MPH	20 MPH	2 MPH	3 MPH	4 MPH	5 MPH
DG80015† DG110015 (100)	30	M	M	0.13	17	9.7	7.7	6.4	4.8	3.9	3.2	2.6	1.9	0.44	0.29	0.22	0.18
	35	M	M	0.14	18	10.4	8.3	6.9	5.2	4.2	3.5	2.8	2.1	0.48	0.32	0.24	0.19
	40	F	M	0.15	19	11.1	8.9	7.4	5.6	4.5	3.7	3.0	2.2	0.51	0.34	0.26	0.20
	50	F	M	0.17	22	12.6	10.1	8.4	6.3	5.0	4.2	3.4	2.5	0.58	0.39	0.29	0.23
	60	F	F	0.18	23	13.4	10.7	8.9	6.7	5.3	4.5	3.6	2.7	0.61	0.41	0.31	0.24
DG8002† DG11002 (50)	30	C	C	0.17	22	12.6	10.1	8.4	6.3	5.0	4.2	3.4	2.5	0.58	0.39	0.29	0.23
	35	M	C	0.19	24	14.1	11.3	9.4	7.1	5.6	4.7	3.8	2.8	0.65	0.43	0.32	0.26
	40	M	M	0.20	26	14.9	11.9	9.9	7.4	5.9	5.0	4.0	3.0	0.68	0.45	0.34	0.27
	50	M	M	0.22	28	16.3	13.1	10.9	8.2	6.5	5.4	4.4	3.3	0.75	0.50	0.37	0.30
	60	M	M	0.24	31	17.8	14.3	11.9	8.9	7.1	5.9	4.8	3.6	0.82	0.54	0.41	0.33
DG8003† DG11003 (50)	30	C	C	0.26	33	19.3	15.4	12.9	9.7	7.7	6.4	5.1	3.9	0.88	0.59	0.44	0.35
	35	M	C	0.28	36	21	16.6	13.9	10.4	8.3	6.9	5.5	4.2	0.95	0.63	0.48	0.38
	40	M	M	0.30	38	22	17.8	14.9	11.1	8.9	7.4	5.9	4.5	1.0	0.68	0.51	0.41
	50	M	M	0.34	44	25	20	16.8	12.6	10.1	8.4	6.7	5.0	1.2	0.77	0.58	0.46
	60	M	M	0.37	47	27	22	18.3	13.7	11.0	9.2	7.3	5.5	1.3	0.84	0.63	0.50
DG8004† DG11004 (50)	30	C	C	0.35	45	26	21	17.3	13.0	10.4	8.7	6.9	5.2	1.2	0.79	0.60	0.48
	35	M	C	0.37	47	27	22	18.3	13.7	11.0	9.2	7.3	5.5	1.3	0.84	0.63	0.50
	40	M	M	0.40	51	30	24	19.8	14.9	11.9	9.9	7.9	5.9	1.4	0.91	0.68	0.54
	50	M	M	0.45	58	33	27	22	16.7	13.4	11.1	8.9	6.7	1.5	1.0	0.77	0.61
	60	M	M	0.49	63	36	29	24	18.2	14.6	12.1	9.7	7.3	1.7	1.1	0.83	0.67
DG8005† DG11005 (50)	30	C	C	0.43	55	32	26	21	16.0	12.8	10.6	8.5	6.4	1.5	0.97	0.73	0.58
	35	C	C	0.47	60	35	28	23	17.4	14.0	11.6	9.3	7.0	1.6	1.1	0.80	0.64
	40	C	C	0.50	64	37	30	25	18.6	14.9	12.4	9.9	7.4	1.7	1.1	0.85	0.68
	50	M	M	0.56	72	42	33	28	21	16.6	13.9	11.1	8.3	1.9	1.3	0.95	0.76
	60	M	M	0.61	78	45	36	30	23	18.1	15.1	12.1	9.1	2.1	1.4	1.0	0.83

**Note:** Always double check your application rates. Droplet size classification shown is based on ISO 25358. Droplet size classification standard is subject to change. Tabulations are based on spraying water at 70°F. See technical information (pages 179–202) for droplet size classification, useful formulas and other technical information.

†Available in VisiFlo stainless steel only.







BROADCAST NOZZLES

## Typical Applications



**HERBICIDE**  
SOIL APPLIED  
**GOOD**  
CONTACT  
**EXCELLENT**  
SYSTEMIC  
**VERY GOOD**



**FUNGICIDE**  
CONTACT  
**EXCELLENT**  
SYSTEMIC  
**VERY GOOD**



**INSECTICIDE**  
CONTACT  
**EXCELLENT**  
SYSTEMIC  
**VERY GOOD**



**DRIFT CONTROL**  
**VERY GOOD**



**PWM APPROVED**



## FEATURES

- Dual outlet design produces two 110° flat fan spray patterns using the patented technology from the Turbo TeeJet® nozzle. The angle between each spray pattern is 60° forward and back.
- Best suited for broadcast spraying where superior leaf coverage and canopy penetration is important.
- Droplet size range is slightly larger than the same capacity Turbo TeeJet nozzle providing drift-reducing properties with increased canopy coverage and penetration.
- Available in eight VisiFlo® Polymer (VP) capacities.
- For replacement, use the automatic alignment Quick TeeJet cap and gasket 114441A-\*CELR. See page 118 for additional information.

## SPRAY PATTERN

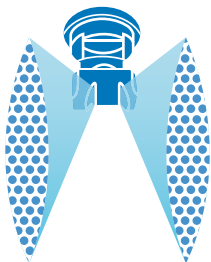

## DROPLET SIZE CLASSIFICATION

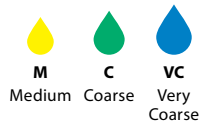

## OPTIMUM SPRAY HEIGHT

 <b>ANGLE</b> 110°	<b>20° SPACING</b>  <b>HEIGHT</b> 20°
--------------------------	--

## RECOMMENDED PRESSURE RANGE



## MATERIALS AVAILABLE



## HOW TO ORDER

Polymer with VisiFlo color-coding

**T T J 6 0 - 1 1 0 0 4 V P**

Tip Type      Spray Angle      Capacity Size      Material Code

Polymer with VisiFlo color-coding, includes Quick TeeJet cap and gasket\*

**T T J 6 0 - 1 1 0 0 3 V P - C E**

Tip Type      Spray Angle      Capacity Size      Material Code      Cap and Gasket Included

\*Reference page 118 for more caps information.



BROADCAST NOZZLES

TIP PART NO. (STRAINER MESH SIZE)	PSI	DROP SIZE	CAPACITY ONE TIP IN GPM	CAPACITY ONE TIP IN OZ/MIN	APPLICATION RATE FOR 20" SPRAY TIP SPACING											
					GALLONS PER ACRE (GPA)								TURF APPLICATION GALLONS PER 1000 SQ. FT.			
					4 MPH	5 MPH	6 MPH	8 MPH	10 MPH	12 MPH	15 MPH	20 MPH	2 MPH	3 MPH	4 MPH	5 MPH
TTJ60-11002 (100)	20	C	0.14	18	10.4	8.3	6.9	5.2	4.2	3.5	2.8	2.1	0.48	0.32	0.24	0.19
	30	C	0.17	22	12.6	10.1	8.4	6.3	5.0	4.2	3.4	2.5	0.58	0.39	0.29	0.23
	40	M	0.20	26	14.9	11.9	9.9	7.4	5.9	5.0	4.0	3.0	0.68	0.45	0.34	0.27
	50	M	0.22	28	16.3	13.1	10.9	8.2	6.5	5.4	4.4	3.3	0.75	0.50	0.37	0.30
	60	M	0.24	31	17.8	14.3	11.9	8.9	7.1	5.9	4.8	3.6	0.82	0.54	0.41	0.33
	70	M	0.26	33	19.3	15.4	12.9	9.7	7.7	6.4	5.1	3.9	0.88	0.59	0.44	0.35
	80	M	0.28	36	21	16.6	13.9	10.4	8.3	6.9	5.5	4.2	0.95	0.63	0.48	0.38
90	M	0.30	38	22	17.8	14.9	11.1	8.9	7.4	5.9	4.5	1.0	0.68	0.51	0.41	
TTJ60-110025 (100)	20	VC	0.18	23	13.4	10.7	8.9	6.7	5.3	4.5	3.6	2.7	0.61	0.41	0.31	0.24
	30	C	0.22	28	16.3	13.1	10.9	8.2	6.5	5.4	4.4	3.3	0.75	0.50	0.37	0.30
	40	M	0.25	32	18.6	14.9	12.4	9.3	7.4	6.2	5.0	3.7	0.85	0.57	0.43	0.34
	50	M	0.28	36	21	16.6	13.9	10.4	8.3	6.9	5.5	4.2	0.95	0.63	0.48	0.38
	60	M	0.31	40	23	18.4	15.3	11.5	9.2	7.7	6.1	4.6	1.1	0.70	0.53	0.42
	70	M	0.33	42	25	19.6	16.3	12.3	9.8	8.2	6.5	4.9	1.1	0.75	0.56	0.45
	80	M	0.35	45	26	21	17.3	13.0	10.4	8.7	6.9	5.2	1.2	0.79	0.60	0.48
90	M	0.38	49	28	23	18.8	14.1	11.3	9.4	7.5	5.6	1.3	0.86	0.65	0.52	
TTJ60-11003 (100)	20	VC	0.21	27	15.6	12.5	10.4	7.8	6.2	5.2	4.2	3.1	0.71	0.48	0.36	0.29
	30	C	0.26	33	19.3	15.4	12.9	9.7	7.7	6.4	5.1	3.9	0.88	0.59	0.44	0.35
	40	C	0.30	38	22	17.8	14.9	11.1	8.9	7.4	5.9	4.5	1.0	0.68	0.51	0.41
	50	M	0.34	44	25	20	16.8	12.6	10.1	8.4	6.7	5.0	1.2	0.77	0.58	0.46
	60	M	0.37	47	27	22	18.3	13.7	11.0	9.2	7.3	5.5	1.3	0.84	0.63	0.50
	70	M	0.40	51	30	24	19.8	14.9	11.9	9.9	7.9	5.9	1.4	0.91	0.68	0.54
	80	M	0.42	54	31	25	21	15.6	12.5	10.4	8.3	6.2	1.4	0.95	0.71	0.57
90	M	0.45	58	33	27	22	16.7	13.4	11.1	8.9	6.7	1.5	1.0	0.77	0.61	
TTJ60-11004 (50)	20	VC	0.28	36	21	16.6	13.9	10.4	8.3	6.9	5.5	4.2	0.95	0.63	0.48	0.38
	30	C	0.35	45	26	21	17.3	13.0	10.4	8.7	6.9	5.2	1.2	0.79	0.60	0.48
	40	C	0.40	51	30	24	19.8	14.9	11.9	9.9	7.9	5.9	1.4	0.91	0.68	0.54
	50	M	0.45	58	33	27	22	16.7	13.4	11.1	8.9	6.7	1.5	1.0	0.77	0.61
	60	M	0.49	63	36	29	24	18.2	14.6	12.1	9.7	7.3	1.7	1.1	0.83	0.67
	70	M	0.53	68	39	31	26	19.7	15.7	13.1	10.5	7.9	1.8	1.2	0.90	0.72
	80	M	0.57	73	42	34	28	21	16.9	14.1	11.3	8.5	1.9	1.3	0.97	0.78
90	M	0.60	77	45	36	30	22	17.8	14.9	11.9	8.9	2.0	1.4	1.0	0.82	
TTJ60-11005 (50)	20	VC	0.35	45	26	21	17.3	13.0	10.4	8.7	6.9	5.2	1.2	0.79	0.60	0.48
	30	C	0.43	55	32	26	21	16.0	12.8	10.6	8.5	6.4	1.5	0.97	0.73	0.58
	40	C	0.50	64	37	30	25	18.6	14.9	12.4	9.9	7.4	1.7	1.1	0.85	0.68
	50	M	0.56	72	42	33	28	21	16.6	13.9	11.1	8.3	1.9	1.3	0.95	0.76
	60	M	0.61	78	45	36	30	23	18.1	15.1	12.1	9.1	2.1	1.4	1.0	0.83
	70	M	0.66	84	49	39	33	25	19.6	16.3	13.1	9.8	2.2	1.5	1.1	0.90
	80	M	0.71	91	53	42	35	26	21	17.6	14.1	10.5	2.4	1.6	1.2	0.97
90	M	0.75	96	56	45	37	28	22	18.6	14.9	11.1	2.6	1.7	1.3	1.0	
TTJ60-11006 (50)	20	VC	0.42	54	31	25	21	15.6	12.5	10.4	8.3	6.2	1.4	0.95	0.71	0.57
	30	C	0.52	67	39	31	26	19.3	15.4	12.9	10.3	7.7	1.8	1.2	0.88	0.71
	40	C	0.60	77	45	36	30	22	17.8	14.9	11.9	8.9	2.0	1.4	1.0	0.82
	50	M	0.67	86	50	40	33	25	19.9	16.6	13.3	9.9	2.3	1.5	1.1	0.91
	60	M	0.73	93	54	43	36	27	22	18.1	14.5	10.8	2.5	1.7	1.2	0.99
	70	M	0.79	101	59	47	39	29	23	19.6	15.6	11.7	2.7	1.8	1.3	1.1
	80	M	0.85	109	63	50	42	32	25	21	16.8	12.6	2.9	1.9	1.4	1.2
90	M	0.90	115	67	53	45	33	27	22	17.8	13.4	3.1	2.0	1.5	1.2	
TTJ60-11008 (50)	20	VC	0.57	73	42	34	28	21	16.9	14.1	11.3	8.5	1.9	1.3	0.97	0.78
	30	C	0.69	88	51	41	34	26	20	17.1	13.7	10.2	2.3	1.6	1.2	0.94
	40	C	0.80	102	59	48	40	30	24	19.8	15.8	11.9	2.7	1.8	1.4	1.09
	50	C	0.89	114	66	53	44	33	26	22	17.6	13.2	3.0	2.0	1.5	1.2
	60	M	0.98	125	73	58	49	36	29	24	19.4	14.6	3.3	2.2	1.7	1.3
	70	M	1.06	136	79	63	52	39	31	26	21	15.7	3.6	2.4	1.8	1.4
	80	M	1.13	145	84	67	56	42	34	28	22	16.8	3.8	2.6	1.9	1.5
90	M	1.20	154	89	71	59	45	36	30	24	17.8	4.1	2.7	2.0	1.6	
TTJ60-11010 (50)	20	VC	0.71	91	53	42	35	26	21	17.6	14.1	10.5	2.4	1.6	1.2	0.97
	30	C	0.87	111	65	52	43	32	26	22	17.2	12.9	3.0	2.0	1.5	1.2
	40	C	1.00	128	74	59	50	37	30	25	19.8	14.9	3.4	2.3	1.7	1.4
	50	C	1.12	143	83	67	55	42	33	28	22	16.6	3.8	2.5	1.9	1.5
	60	M	1.22	156	91	72	60	45	36	30	24	18.1	4.1	2.8	2.1	1.7
	70	M	1.32	169	98	78	65	49	39	33	26	19.6	4.5	3.0	2.2	1.8
	80	M	1.41	180	105	84	70	52	42	35	28	21	4.8	3.2	2.4	1.9
90	M	1.50	192	111	89	74	56	45	37	30	22	5.1	3.4	2.6	2.0	

**Note:** Always double check your application rates. Droplet size classification shown is based on ISO 25358. Droplet size classification standard is subject to change. Tabulations are based on spraying water at 70°F. See technical information (pages 179–202) for droplet size classification, useful formulas and other technical information.



BROADCAST NOZZLES

### Typical Applications



**HERBICIDE**  
SOIL APPLIED  
**VERY GOOD**  
CONTACT  
**VERY GOOD**  
SYSTEMIC  
**EXCELLENT**



**FUNGICIDE**  
CONTACT  
**GOOD**  
SYSTEMIC  
**EXCELLENT**



**INSECTICIDE**  
CONTACT  
**GOOD**  
SYSTEMIC  
**EXCELLENT**



**DRIFT CONTROL**  
**EXCELLENT**



**PWM APPROVED**



### FEATURES

- Dual tapered edge spray tip with air-induction technology.
- The combination of the dual symmetric 110° flat fan pattern and the 60° angle between spray pattern in addition to the greater number of droplets results in a superior crop coverage and penetration, while providing excellent drift control.
- Available in nine VisiFlo® Polymer (VP) capacities.
- Automatic spray alignment with Quick TeeJet cap and gasket 114443A-\*CELR (02 to 06) or 114502A-\*CELR (08 to 15). See page 118 for additional information.

### SPRAY PATTERN

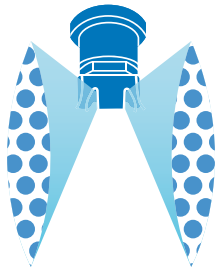

### DROPLET SIZE CLASSIFICATION

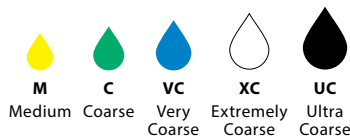

### OPTIMUM SPRAY HEIGHT

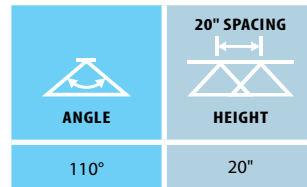

### RECOMMENDED PRESSURE RANGE



### MATERIALS AVAILABLE



### HOW TO ORDER

Polymer with VisiFlo color-coding

**A I T T J 6 0 - 1 1 0 0 4 V P**

Tip Type      Spray Angle      Capacity Size      Material Code

Polymer with VisiFlo color-coding, includes Quick TeeJet cap and gasket\*

**A I T T J 6 0 - 1 1 0 0 4 V P - C E**

Tip Type      Spray Angle      Capacity Size      Material Code      Cap and Gasket Included

\*Reference page 118 for more caps information.



BROADCAST NOZZLES

TIP PART NO. (STRAINER MESH SIZE)	PSI	DROP SIZE	CAPACITY ONE TIP IN GPM	CAPACITY ONE TIP IN OZ/MIN	APPLICATION RATE FOR 20" SPRAY TIP SPACING													
					GALLONS PER ACRE (GPA)								TURF APPLICATION GALLONS PER 1000 SQ. FT.					
					4 MPH	5 MPH	6 MPH	8 MPH	10 MPH	12 MPH	15 MPH	20 MPH	2 MPH	3 MPH	4 MPH	5 MPH		
AITTJ60-11002VP (100)	20	XC	0.14	18	10.4	8.3	6.9	5.2	4.2	3.5	2.8	2.1	0.48	0.32	0.24	0.19		
	30	VC	0.17	22	12.6	10.1	8.4	6.3	5.0	4.2	3.4	2.5	0.58	0.39	0.29	0.23		
	40	VC	0.20	26	14.9	11.9	9.9	7.4	5.9	5.0	4.0	3.0	0.68	0.45	0.34	0.27		
	50	C	0.22	28	16.3	13.1	10.9	8.2	6.5	5.4	4.4	3.3	0.75	0.50	0.37	0.30		
	60	C	0.24	31	17.8	14.3	11.9	8.9	7.1	5.9	4.8	3.6	0.82	0.54	0.41	0.33		
	70	C	0.26	33	19.3	15.4	12.9	9.7	7.7	6.4	5.1	3.9	0.88	0.59	0.44	0.35		
	80	C	0.28	36	21	16.6	13.9	10.4	8.3	6.9	5.5	4.2	0.95	0.63	0.48	0.38		
90	M	0.30	38	22	17.8	14.9	11.1	8.9	7.4	5.9	4.5	1.0	0.68	0.51	0.41			
AITTJ60-110025VP (100)	20	XC	0.18	23	13.4	10.7	8.9	6.7	5.3	4.5	3.6	2.7	0.61	0.41	0.31	0.24		
	30	VC	0.22	28	16.3	13.1	10.9	8.2	6.5	5.4	4.4	3.3	0.75	0.50	0.37	0.30		
	40	VC	0.25	32	18.6	14.9	12.4	9.3	7.4	6.2	5.0	3.7	0.85	0.57	0.43	0.34		
	50	VC	0.28	36	21	16.6	13.9	10.4	8.3	6.9	5.5	4.2	0.95	0.63	0.48	0.38		
	60	C	0.31	40	23	18.4	15.3	11.5	9.2	7.7	6.1	4.6	1.1	0.70	0.53	0.42		
	70	C	0.33	42	25	19.6	16.3	12.3	9.8	8.2	6.5	4.9	1.1	0.75	0.56	0.45		
	80	C	0.35	45	26	21	17.3	13.0	10.4	8.7	6.9	5.2	1.2	0.79	0.60	0.48		
90	C	0.38	49	28	23	18.8	14.1	11.3	9.4	7.5	5.6	1.3	0.86	0.65	0.52			
AITTJ60-11003VP (50)	20	XC	0.21	27	15.6	12.5	10.4	7.8	6.2	5.2	4.2	3.1	0.71	0.48	0.36	0.29		
	30	XC	0.26	33	19.3	15.4	12.9	9.7	7.7	6.4	5.1	3.9	0.88	0.59	0.44	0.35		
	40	VC	0.30	38	22	17.8	14.9	11.1	8.9	7.4	5.9	4.5	1.0	0.68	0.51	0.41		
	50	VC	0.34	44	25	20	16.8	12.6	10.1	8.4	6.7	5.0	1.2	0.77	0.58	0.46		
	60	C	0.37	47	27	22	18.3	13.7	11.0	9.2	7.3	5.5	1.3	0.84	0.63	0.50		
	70	C	0.40	51	30	24	19.8	14.9	11.9	9.9	7.9	5.9	1.4	0.91	0.68	0.54		
	80	C	0.42	54	31	25	21	15.6	12.5	10.4	8.3	6.2	1.4	0.95	0.71	0.57		
90	C	0.45	58	33	27	22	16.7	13.4	11.1	8.9	6.7	1.5	1.0	0.77	0.61			
AITTJ60-11004VP (50)	20	XC	0.28	36	21	16.6	13.9	10.4	8.3	6.9	5.5	4.2	0.95	0.63	0.48	0.38		
	30	XC	0.35	45	26	21	17.3	13.0	10.4	8.7	6.9	5.2	1.2	0.79	0.60	0.48		
	40	VC	0.40	51	30	24	19.8	14.9	11.9	9.9	7.9	5.9	1.4	0.91	0.68	0.54		
	50	VC	0.45	58	33	27	22	16.7	13.4	11.1	8.9	6.7	1.5	1.0	0.77	0.61		
	60	C	0.49	63	36	29	24	18.2	14.6	12.1	9.7	7.3	1.7	1.1	0.83	0.67		
	70	C	0.53	68	39	31	26	19.7	15.7	13.1	10.5	7.9	1.8	1.2	0.90	0.72		
	80	C	0.57	73	42	34	28	21	16.9	14.1	11.3	8.5	1.9	1.3	0.97	0.78		
90	C	0.60	77	45	36	30	22	17.8	14.9	11.9	8.9	2.0	1.4	1.0	0.82			
AITTJ60-11005VP (50)	20	UC	0.35	45	26	21	17.3	13.0	10.4	8.7	6.9	5.2	1.2	0.79	0.60	0.48		
	30	XC	0.43	55	32	26	21	16.0	12.8	10.6	8.5	6.4	1.5	0.97	0.73	0.58		
	40	VC	0.50	64	37	30	25	18.6	14.9	12.4	9.9	7.4	1.7	1.1	0.85	0.68		
	50	VC	0.56	72	42	33	28	21	16.6	13.9	11.1	8.3	1.9	1.3	0.95	0.76		
	60	VC	0.61	78	45	36	30	23	18.1	15.1	12.1	9.1	2.1	1.4	1.0	0.83		
	70	C	0.66	84	49	39	33	25	19.6	16.3	13.1	9.8	2.2	1.5	1.1	0.90		
	80	C	0.71	91	53	42	35	26	21	17.6	14.1	10.5	2.4	1.6	1.2	0.97		
90	C	0.75	96	56	45	37	28	22	18.6	14.9	11.1	2.6	1.7	1.3	1.0			
AITTJ60-11006VP (50)	20	UC	0.42	54	31	25	21	15.6	12.5	10.4	8.3	6.2	1.4	0.95	0.71	0.57		
	30	XC	0.52	67	39	31	26	19.3	15.4	12.9	10.3	7.7	1.8	1.2	0.88	0.71		
	40	VC	0.60	77	45	36	30	22	17.8	14.9	11.9	8.9	2.0	1.4	1.0	0.82		
	50	VC	0.67	86	50	40	33	25	19.9	16.6	13.3	9.9	2.3	1.5	1.1	0.91		
	60	VC	0.73	93	54	43	36	27	22	18.1	14.5	10.8	2.5	1.7	1.2	0.99		
	70	C	0.79	101	59	47	39	29	23	19.6	15.6	11.7	2.7	1.8	1.3	1.1		
	80	C	0.85	109	63	50	42	32	25	21	16.8	12.6	2.9	1.9	1.4	1.2		
90	C	0.90	115	67	53	45	33	27	22	17.8	13.4	3.1	2.0	1.5	1.2			
AITTJ60-11008VP (50)	20	UC	0.57	73	42	34	28	21	16.9	14.1	11.3	8.5	1.9	1.3	0.97	0.78		
	30	XC	0.69	88	51	41	34	26	20	17.1	13.7	10.2	2.3	1.6	1.2	0.94		
	40	XC	0.80	102	59	48	40	30	24	19.8	15.8	11.9	2.7	1.8	1.4	1.09		
	50	XC	0.89	114	66	53	44	33	26	22	17.6	13.2	3.0	2.0	1.5	1.2		
	60	VC	0.98	125	73	58	49	36	29	24	19.4	14.6	3.3	2.2	1.7	1.3		
	70	VC	1.06	136	79	63	52	39	31	26	21	15.7	3.6	2.4	1.8	1.4		
	80	VC	1.13	145	84	67	56	42	34	28	22	16.8	3.8	2.6	1.9	1.5		
90	VC	1.20	154	89	71	59	45	36	30	24	17.8	4.1	2.7	2.0	1.6			
AITTJ60-11010VP (50)	20	UC	0.71	91	53	42	35	26	21	17.6	14.1	10.5	2.4	1.6	1.2	0.97		
	30	XC	0.87	111	65	52	43	32	26	22	17.2	12.9	3.0	2.0	1.5	1.2		
	40	XC	1.00	128	74	59	50	37	30	25	19.8	14.9	3.4	2.3	1.7	1.4		
	50	XC	1.12	143	83	67	55	42	33	28	22	16.6	3.8	2.5	1.9	1.5		
	60	VC	1.22	156	91	72	60	45	36	30	24	18.1	4.1	2.8	2.1	1.7		
	70	VC	1.32	169	98	78	65	49	39	33	26	19.6	4.5	3.0	2.2	1.8		
	80	VC	1.41	180	105	84	70	52	42	35	28	21	4.8	3.2	2.4	1.9		
90	VC	1.50	192	111	89	74	56	45	37	30	22	5.1	3.4	2.6	2.0			
AITTJ60-11015VP (50)	20	UC	1.06	136	79	63	52	39	31	26	21	15.7	3.6	2.4	1.8	1.4		
	30	XC	1.30	166	97	77	64	48	39	32	26	19.3	4.4	2.9	2.2	1.8		
	40	XC	1.50	192	111	89	74	56	45	37	30	22	5.1	3.4	2.6	2.0		
	50	XC	1.68	215	125	100	83	62	50	42	33	25	5.7	3.8	2.9	2.3		
	60	VC	1.84	236	137	109	91	68	55	46	36	27	6.3	4.2	3.1	2.5		
	70	VC	1.98	253	147	118	98	74	59	49	39	29	6.7	4.5	3.4	2.7		
	80	VC	2.12	271	157	126	105	79	63	52	42	31	7.2	4.8	3.6	2.9		
90	VC	2.25	288	167	134	111	84	67	56	45	33	7.7	5.1	3.8	3.1			

**Note:** Always double check your application rates. Droplet size classification shown is based on ISO 25358. Droplet size classification standard is subject to change. Tabulations are based on spraying water at 70°F. See technical information (pages 179–202) for droplet size classification, useful formulas and other technical information.



### Typical Applications



**FUNGICIDE**  
CONTACT  
**EXCELLENT**  
SYSTEMIC  
**VERY GOOD**



**DRIFT CONTROL**  
**VERY GOOD**



### FEATURES

- Provides excellent penetration and seed head coverage for fungicide spraying on cereal crops.
- AI3070 produces two wide angle, flat spray patterns for uniform coverage in broadcast applications.
- 30° forward tilted spray penetrates dense crop canopies, while the backward tilted 70° spray maximizes coverage of the crop seed head.
- Drift resistant droplets are produced through the use of a Venturi air aspirator.
- Available in six VisiFlo® Polymer (VP) capacities.
- Due to the spray tip design, the boom height must be reduced when compared to other flat spray tips (see table below).
- Removable pre-orifice for fast and easy cleaning.
- Automatic spray alignment with Quick TeeJet cap and gasket 98579-1-NYR. Reference page 118 for more information.

### SPRAY PATTERN

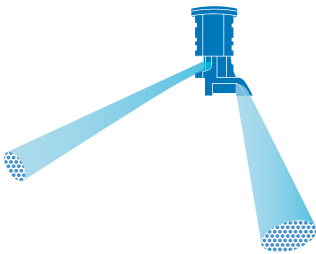

### DROPLET SIZE CLASSIFICATION

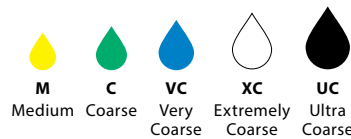

### OPTIMUM SPRAY HEIGHT

<b>HEIGHT</b>	<b>SPACING</b>
12"	20"

### RECOMMENDED PRESSURE RANGE



### MATERIALS AVAILABLE



### HOW TO ORDER

Polymer with VisiFlo color-coding

**A I 3 0 7 0 - 0 4 V P**

Tip Type      Capacity Size      Material Code

Polymer with VisiFlo color-coding, includes Quick TeeJet cap and gasket\*

**A I 3 0 7 0 - 0 3 V P - C**

Tip Type      Capacity Size      Material Code      Cap and Gasket Included

\*Reference page 118 for more caps information.

TIP PART NO. (STRAINER MESH SIZE)	PSI	DROP SIZE	CAPACITY ONE TIP IN GPM	CAPACITY ONE TIP IN OZ/MIN	APPLICATION RATE FOR 20" SPRAY TIP SPACING											
					GALLONS PER ACRE (GPA)								TURF APPLICATION GALLONS PER 1000 SQ. FT.			
					4 MPH	5 MPH	6 MPH	8 MPH	10 MPH	12 MPH	15 MPH	20 MPH	2 MPH	3 MPH	4 MPH	5 MPH
AI3070-015VP (100)	20	XC	0.11	14	8.2	6.5	5.4	4.1	3.3	2.7	2.2	1.6	0.37	0.25	0.19	0.15
	30	VC	0.13	17	9.7	7.7	6.4	4.8	3.9	3.2	2.6	1.9	0.44	0.29	0.22	0.18
	40	VC	0.15	19	11.1	8.9	7.4	5.6	4.5	3.7	3.0	2.2	0.51	0.34	0.26	0.20
	50	C	0.17	22	12.6	10.1	8.4	6.3	5.0	4.2	3.4	2.5	0.58	0.39	0.29	0.23
	60	C	0.18	23	13.4	10.7	8.9	6.7	5.3	4.5	3.6	2.7	0.61	0.41	0.31	0.24
	70	M	0.20	26	14.9	11.9	9.9	7.4	5.9	5.0	4.0	3.0	0.68	0.45	0.34	0.27
	80	M	0.21	27	15.6	12.5	10.4	7.8	6.2	5.2	4.2	3.1	0.71	0.48	0.36	0.29
90	M	0.23	29	17.1	13.7	11.4	8.5	6.8	5.7	4.6	3.4	0.78	0.52	0.39	0.31	
AI3070-02VP (100)	20	XC	0.14	18	10.4	8.3	6.9	5.2	4.2	3.5	2.8	2.1	0.48	0.32	0.24	0.19
	30	VC	0.17	22	12.6	10.1	8.4	6.3	5.0	4.2	3.4	2.5	0.58	0.39	0.29	0.23
	40	VC	0.20	26	14.9	11.9	9.9	7.4	5.9	5.0	4.0	3.0	0.68	0.45	0.34	0.27
	50	C	0.22	28	16.3	13.1	10.9	8.2	6.5	5.4	4.4	3.3	0.75	0.50	0.37	0.30
	60	C	0.24	31	17.8	14.3	11.9	8.9	7.1	5.9	4.8	3.6	0.82	0.54	0.41	0.33
	70	M	0.26	33	19.3	15.4	12.9	9.7	7.7	6.4	5.1	3.9	0.88	0.59	0.44	0.35
	80	M	0.28	36	21	16.6	13.9	10.4	8.3	6.9	5.5	4.2	0.95	0.63	0.48	0.38
90	M	0.30	38	22	17.8	14.9	11.1	8.9	7.4	5.9	4.5	1.0	0.68	0.51	0.41	
AI3070-025VP (100)	20	XC	0.18	23	13.4	10.7	8.9	6.7	5.3	4.5	3.6	2.7	0.61	0.41	0.31	0.24
	30	VC	0.22	28	16.3	13.1	10.9	8.2	6.5	5.4	4.4	3.3	0.75	0.50	0.37	0.30
	40	VC	0.25	32	18.6	14.9	12.4	9.3	7.4	6.2	5.0	3.7	0.85	0.57	0.43	0.34
	50	C	0.28	36	21	16.6	13.9	10.4	8.3	6.9	5.5	4.2	0.95	0.63	0.48	0.38
	60	C	0.31	40	23	18.4	15.3	11.5	9.2	7.7	6.1	4.6	1.1	0.70	0.53	0.42
	70	C	0.33	42	25	19.6	16.3	12.3	9.8	8.2	6.5	4.9	1.1	0.75	0.56	0.45
	80	M	0.35	45	26	21	17.3	13.0	10.4	8.7	6.9	5.2	1.2	0.79	0.60	0.48
90	M	0.38	49	28	23	18.8	14.1	11.3	9.4	7.5	5.6	1.3	0.86	0.65	0.52	
AI3070-03VP (50)	20	XC	0.21	27	15.6	12.5	10.4	7.8	6.2	5.2	4.2	3.1	0.71	0.48	0.36	0.29
	30	VC	0.26	33	19.3	15.4	12.9	9.7	7.7	6.4	5.1	3.9	0.88	0.59	0.44	0.35
	40	VC	0.30	38	22	17.8	14.9	11.1	8.9	7.4	5.9	4.5	1.0	0.68	0.51	0.41
	50	VC	0.34	44	25	20	16.8	12.6	10.1	8.4	6.7	5.0	1.2	0.77	0.58	0.46
	60	C	0.37	47	27	22	18.3	13.7	11.0	9.2	7.3	5.5	1.3	0.84	0.63	0.50
	70	C	0.40	51	30	24	19.8	14.9	11.9	9.9	7.9	5.9	1.4	0.91	0.68	0.54
	80	C	0.42	54	31	25	21	15.6	12.5	10.4	8.3	6.2	1.4	0.95	0.71	0.57
90	M	0.45	58	33	27	22	16.7	13.4	11.1	8.9	6.7	1.5	1.0	0.77	0.61	
AI3070-04VP (50)	20	XC	0.28	36	21	16.6	13.9	10.4	8.3	6.9	5.5	4.2	0.95	0.63	0.48	0.38
	30	XC	0.35	45	26	21	17.3	13.0	10.4	8.7	6.9	5.2	1.2	0.79	0.60	0.48
	40	VC	0.40	51	30	24	19.8	14.9	11.9	9.9	7.9	5.9	1.4	0.91	0.68	0.54
	50	VC	0.45	58	33	27	22	16.7	13.4	11.1	8.9	6.7	1.5	1.0	0.77	0.61
	60	C	0.49	63	36	29	24	18.2	14.6	12.1	9.7	7.3	1.7	1.1	0.83	0.67
	70	C	0.53	68	39	31	26	19.7	15.7	13.1	10.5	7.9	1.8	1.2	0.90	0.72
	80	C	0.57	73	42	34	28	21	16.9	14.1	11.3	8.5	1.9	1.3	0.97	0.78
90	C	0.60	77	45	36	30	22	17.8	14.9	11.9	8.9	2.0	1.4	1.0	0.82	
AI3070-05VP (50)	20	UC	0.35	45	26	21	17.3	13.0	10.4	8.7	6.9	5.2	1.2	0.79	0.60	0.48
	30	XC	0.43	55	32	26	21	16.0	12.8	10.6	8.5	6.4	1.5	0.97	0.73	0.58
	40	VC	0.50	64	37	30	25	18.6	14.9	12.4	9.9	7.4	1.7	1.1	0.85	0.68
	50	VC	0.56	72	42	33	28	21	16.6	13.9	11.1	8.3	1.9	1.3	0.95	0.76
	60	VC	0.61	78	45	36	30	23	18.1	15.1	12.1	9.1	2.1	1.4	1.0	0.83
	70	C	0.66	84	49	39	33	25	19.6	16.3	13.1	9.8	2.2	1.5	1.1	0.90
	80	C	0.71	91	53	42	35	26	21	17.6	14.1	10.5	2.4	1.6	1.2	0.97
90	C	0.75	96	56	45	37	28	22	18.6	14.9	11.1	2.6	1.7	1.3	1.0	

**Note:** Always double check your application rates. Droplet size classification shown is based on ISO 25358. Droplet size classification standard is subject to change. Tabulations are based on spraying water at 70°F. See technical information (pages 179–202) for droplet size classification, useful formulas and other technical information.





BROADCAST NOZZLES

## Typical Applications



**HERBICIDE**  
CONTACT  
**EXCELLENT**



**FUNGICIDE**  
CONTACT  
**EXCELLENT**



**INSECTICIDE**  
CONTACT  
**EXCELLENT**



**PWM**  
**APPROVED**



## FEATURES

- Penetrates crop residue or dense foliage.
- Smaller droplets for thorough coverage.
- Better spray distribution along boom than with hollow cone nozzles.
- Available in stainless steel with VisiFlo® color-coding in 65°, 80° and 110° spray angles.
- See pages 70–71 for TwinJet even flat spray tips.
- Automatic spray alignment with 114443A-\*CEL R Quick TeeJet® cap and gasket. Reference page 118 for more information.

## SPRAY PATTERN

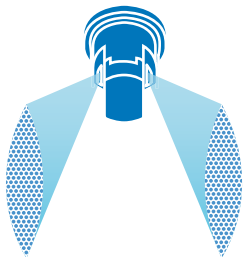

## DROPLET SIZE CLASSIFICATION

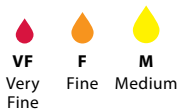

## OPTIMUM SPRAY HEIGHT

ANGLE	HEIGHT
65°	35"
80°	30"
110°	20"

## RECOMMENDED PRESSURE RANGE



## MATERIALS AVAILABLE

**VS** STAINLESS STEEL

## HOW TO ORDER

Stainless Steel with VisiFlo color-coding

**T J 6 0 - 8 0 0 2 V S**

Tip Type    Spray Angle    Capacity Size    Material Code



BROADCAST NOZZLES

TIP PART NO. (STRAINER MESH SIZE)	PSI	DROP SIZE		CAPACITY ONE TIP IN GPM	CAPACITY ONE TIP IN OZ/MIN	APPLICATION RATE FOR 20" SPRAY TIP SPACING													
						GALLONS PER ACRE (GPA)								TURF APPLICATION GALLONS PER 1000 SQ. FT.					
						80°	110°	4 MPH	5 MPH	6 MPH	8 MPH	10 MPH	12 MPH	15 MPH	20 MPH	2 MPH	3 MPH	4 MPH	5 MPH
TJ60-6501 TJ60-8001 (100)	30	F		0.087	11	6.5	5.2	4.3	3.2	2.6	2.2	1.7	1.3	0.30	0.20	0.15	0.12		
	35	F		0.094	12	7.0	5.6	4.7	3.5	2.8	2.3	1.9	1.4	0.32	0.21	0.16	0.13		
	40	F		0.10	13	7.4	5.9	5.0	3.7	3.0	2.5	2.0	1.5	0.34	0.23	0.17	0.14		
	50	VF		0.11	14	8.2	6.5	5.4	4.1	3.3	2.7	2.2	1.6	0.37	0.25	0.19	0.15		
	60	VF		0.12	15	8.9	7.1	5.9	4.5	3.6	3.0	2.4	1.8	0.41	0.27	0.20	0.16		
TJ60-650134 (100)	30			0.12	15	8.9	7.1	5.9	4.5	3.6	3.0	2.4	1.8	0.41	0.27	0.20	0.16		
	35			0.13	17	9.7	7.7	6.4	4.8	3.9	3.2	2.6	1.9	0.44	0.29	0.22	0.18		
	40			0.134	17	9.9	8.0	6.6	5.0	4.0	3.3	2.7	2.0	0.46	0.30	0.23	0.18		
	50			0.15	19	11.1	8.9	7.4	5.6	4.5	3.7	3.0	2.2	0.51	0.34	0.26	0.20		
	60			0.16	20	11.9	9.5	7.9	5.9	4.8	4.0	3.2	2.4	0.54	0.36	0.27	0.22		
TJ60-6502 TJ60-8002 TJ60-11002 (100)	30	F	F	0.17	22	12.6	10.1	8.4	6.3	5.0	4.2	3.4	2.5	0.58	0.39	0.29	0.23		
	35	F	F	0.19	24	14.1	11.3	9.4	7.1	5.6	4.7	3.8	2.8	0.65	0.43	0.32	0.26		
	40	F	F	0.20	26	14.9	11.9	9.9	7.4	5.9	5.0	4.0	3.0	0.68	0.45	0.34	0.27		
	50	F	F	0.22	28	16.3	13.1	10.9	8.2	6.5	5.4	4.4	3.3	0.75	0.50	0.37	0.30		
	60	F	F	0.24	31	17.8	14.3	11.9	8.9	7.1	5.9	4.8	3.6	0.82	0.54	0.41	0.33		
TJ60-6503 TJ60-8003 TJ60-11003 (100)	30	F	F	0.26	33	19.3	15.4	12.9	9.7	7.7	6.4	5.1	3.9	0.88	0.59	0.44	0.35		
	35	F	F	0.28	36	21	16.6	13.9	10.4	8.3	6.9	5.5	4.2	0.95	0.63	0.48	0.38		
	40	F	F	0.30	38	22	17.8	14.9	11.1	8.9	7.4	5.9	4.5	1.0	0.68	0.51	0.41		
	50	F	F	0.34	44	25	20	16.8	12.6	10.1	8.4	6.7	5.0	1.2	0.77	0.58	0.46		
	60	F	F	0.37	47	27	22	18.3	13.7	11.0	9.2	7.3	5.5	1.3	0.84	0.63	0.50		
TJ60-6504 TJ60-8004 TJ60-11004 (50)	30	F	F	0.35	45	26	21	17.3	13.0	10.4	8.7	6.9	5.2	1.2	0.79	0.60	0.48		
	35	F	F	0.37	47	27	22	18.3	13.7	11.0	9.2	7.3	5.5	1.3	0.84	0.63	0.50		
	40	F	F	0.40	51	30	24	19.8	14.9	11.9	9.9	7.9	5.9	1.4	0.91	0.68	0.54		
	50	F	F	0.45	58	33	27	22	16.7	13.4	11.1	8.9	6.7	1.5	1.0	0.77	0.61		
	60	F	F	0.49	63	36	29	24	18.2	14.6	12.1	9.7	7.3	1.7	1.1	0.83	0.67		
TJ60-8005 TJ60-11005 (50)	30	M	M	0.43	55	32	26	21	16.0	12.8	10.6	8.5	6.4	1.5	0.97	0.73	0.58		
	35	M	M	0.47	60	35	28	23	17.4	14.0	11.6	9.3	7.0	1.6	1.07	0.80	0.64		
	40	M	M	0.50	64	37	30	25	18.6	14.9	12.4	9.9	7.4	1.7	1.13	0.85	0.68		
	50	M	M	0.56	72	42	33	28	21	16.6	13.9	11.1	8.3	1.9	1.3	0.95	0.76		
	60	F	F	0.61	78	45	36	30	23	18.1	15.1	12.1	9.1	2.1	1.4	1.04	0.83		
TJ60-6506 TJ60-8006 TJ60-11006 (50)	30	M	M	0.52	67	39	31	26	19.3	15.4	12.9	10.3	7.7	1.8	1.2	0.88	0.71		
	35	M	M	0.56	72	42	33	28	21	16.6	13.9	11.1	8.3	1.9	1.3	0.95	0.76		
	40	M	M	0.60	77	45	36	30	22	17.8	14.9	11.9	8.9	2.0	1.4	1.0	0.82		
	50	M	M	0.67	86	50	40	33	25	19.9	16.6	13.3	9.9	2.3	1.5	1.1	0.91		
	60	M	M	0.73	93	54	43	36	27	22	18.1	14.5	10.8	2.5	1.7	1.2	0.99		
TJ60-6508 TJ60-8008 TJ60-11008 (50)	30	M	M	0.69	88	51	41	34	26	20	17.1	13.7	10.2	2.3	1.6	1.2	0.94		
	35	M	M	0.75	96	56	45	37	28	22	18.6	14.9	11.1	2.6	1.7	1.3	1.0		
	40	M	M	0.80	102	59	48	40	30	24	19.8	15.8	11.9	2.7	1.8	1.4	1.1		
	50	M	M	0.89	114	66	53	44	33	26	22	17.6	13.2	3.0	2.0	1.5	1.2		
	60	M	M	0.98	125	73	58	49	36	29	24	19.4	14.6	3.3	2.2	1.7	1.3		
TJ60-8010 TJ60-11010 (50)	30	M	M	0.87	111	65	52	43	32	26	22	17.2	12.9	3.0	2.0	1.5	1.2		
	35	M	M	0.94	120	70	56	47	35	28	23	18.6	14.0	3.2	2.1	1.6	1.3		
	40	M	M	1.00	128	74	59	50	37	30	25	19.8	14.9	3.4	2.3	1.7	1.4		
	50	M	M	1.12	143	83	67	55	42	33	28	22	16.6	3.8	2.5	1.9	1.5		
	60	M	M	1.22	156	91	72	60	45	36	30	24	18.1	4.1	2.8	2.1	1.7		

**Note:** Always double check your application rates. Droplet size classification shown is based on ISO 25358. Droplet size classification standard is subject to change. Tabulations are based on spraying water at 70°F. See technical information (pages 179–202) for droplet size classification, useful formulas and other technical information.





## Typical Applications



**HERBICIDE**  
SOIL APPLIED  
**VERY GOOD**  
CONTACT  
**VERY GOOD**  
SYSTEMIC  
**VERY GOOD**



**FUNGICIDE**  
CONTACT  
**VERY GOOD**  
SYSTEMIC  
**EXCELLENT**



**INSECTICIDE**  
CONTACT  
**VERY GOOD**  
SYSTEMIC  
**EXCELLENT**



**FERTILIZER**  
BROADCAST  
**GOOD**



**DRIFT CONTROL**  
**GOOD**



## FEATURES

- Dual 110°, tapered edge, flat fan spray patterns spraying 60° forward to back providing better canopy coverage and penetration in broadcast spraying applications.
- DG TwinJet offers larger droplets and improved drift control compared to a standard twin flat spray tip of equal capacity.
- Removable polymer pre-orifice.

## SPRAY PATTERN

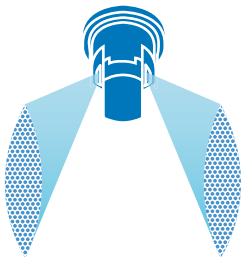

## DROPLET SIZE CLASSIFICATION

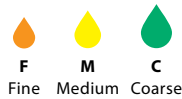

## OPTIMUM SPRAY HEIGHT

<b>ANGLE</b>	<b>HEIGHT</b>
110°	20"

## RECOMMENDED PRESSURE RANGE



## MATERIALS AVAILABLE

**VS** STAINLESS STEEL

## HOW TO ORDER

Stainless Steel with VisiFlo® color-coding

**D G T J 6 0 - 1 1 0 0 4 V S**

Tip Type

Spray Angle

Capacity Size

Material Code

TIP PART NO. (STRAINER MESH SIZE)	PSI	DROP SIZE	CAPACITY ONE TIP IN GPM	CAPACITY ONE TIP IN OZ/MIN	APPLICATION RATE FOR 20" SPRAY TIP SPACING											
					GALLONS PER ACRE (GPA)								TURF APPLICATION GALLONS PER 1000 SQ. FT.			
					4 MPH	5 MPH	6 MPH	8 MPH	10 MPH	12 MPH	15 MPH	20 MPH	2 MPH	3 MPH	4 MPH	5 MPH
DGTJ60-110015 (100)	30	M	0.13	17	9.7	7.7	6.4	4.8	3.9	3.2	2.6	1.9	0.44	0.29	0.22	0.18
	35	M	0.14	18	10.4	8.3	6.9	5.2	4.2	3.5	2.8	2.1	0.48	0.32	0.24	0.19
	40	F	0.15	19	11.1	8.9	7.4	5.6	4.5	3.7	3.0	2.2	0.51	0.34	0.26	0.20
	50	F	0.17	22	12.6	10.1	8.4	6.3	5.0	4.2	3.4	2.5	0.58	0.39	0.29	0.23
	60	F	0.18	23	13.4	10.7	8.9	6.7	5.3	4.5	3.6	2.7	0.61	0.41	0.31	0.24
DGTJ60-11002 (100)	30	M	0.17	22	12.6	10.1	8.4	6.3	5.0	4.2	3.4	2.5	0.58	0.39	0.29	0.23
	35	M	0.19	24	14.1	11.3	9.4	7.1	5.6	4.7	3.8	2.8	0.65	0.43	0.32	0.26
	40	M	0.20	26	14.9	11.9	9.9	7.4	5.9	5.0	4.0	3.0	0.68	0.45	0.34	0.27
	50	M	0.22	28	16.3	13.1	10.9	8.2	6.5	5.4	4.4	3.3	0.75	0.50	0.37	0.30
	60	M	0.24	31	17.8	14.3	11.9	8.9	7.1	5.9	4.8	3.6	0.82	0.54	0.41	0.33
DGTJ60-11003 (100)	30	M	0.26	33	19.3	15.4	12.9	9.7	7.7	6.4	5.1	3.9	0.88	0.59	0.44	0.35
	35	M	0.28	36	21	16.6	13.9	10.4	8.3	6.9	5.5	4.2	0.95	0.63	0.48	0.38
	40	M	0.30	38	22	17.8	14.9	11.1	8.9	7.4	5.9	4.5	1.0	0.68	0.51	0.41
	50	M	0.34	44	25	20	16.8	12.6	10.1	8.4	6.7	5.0	1.2	0.77	0.58	0.46
	60	M	0.37	47	27	22	18.3	13.7	11.0	9.2	7.3	5.5	1.3	0.84	0.63	0.50
DGTJ60-11004 (50)	30	C	0.35	45	26	21	17.3	13.0	10.4	8.7	6.9	5.2	1.2	0.79	0.60	0.48
	35	C	0.37	47	27	22	18.3	13.7	11.0	9.2	7.3	5.5	1.3	0.84	0.63	0.50
	40	C	0.40	51	30	24	19.8	14.9	11.9	9.9	7.9	5.9	1.4	0.91	0.68	0.54
	50	M	0.45	58	33	27	22	16.7	13.4	11.1	8.9	6.7	1.5	1.0	0.77	0.61
	60	M	0.49	63	36	29	24	18.2	14.6	12.1	9.7	7.3	1.7	1.1	0.83	0.67
DGTJ60-11006 (50)	30	C	0.52	67	39	31	26	19.3	15.4	12.9	10.3	7.7	1.8	1.2	0.88	0.71
	35	C	0.56	72	42	33	28	21	16.6	13.9	11.1	8.3	1.9	1.3	0.95	0.76
	40	C	0.60	77	45	36	30	22	17.8	14.9	11.9	8.9	2.0	1.4	1.0	0.82
	50	M	0.67	86	50	40	33	25	19.9	16.6	13.3	9.9	2.3	1.5	1.1	0.91
	60	M	0.73	93	54	43	36	27	22	18.1	14.5	10.8	2.5	1.7	1.2	0.99
DGTJ60-11008 (50)	30	C	0.69	88	51	41	34	26	20	17.1	13.7	10.2	2.3	1.6	1.2	0.94
	35	C	0.75	96	56	45	37	28	22	18.6	14.9	11.1	2.6	1.7	1.3	1.0
	40	C	0.80	102	59	48	40	30	24	19.8	15.8	11.9	2.7	1.8	1.4	1.1
	50	M	0.89	114	66	53	44	33	26	22	17.6	13.2	3.0	2.0	1.5	1.2
	60	M	0.98	125	73	58	49	36	29	24	19.4	14.6	3.3	2.2	1.7	1.3

**Note:** Always double check your application rates. Droplet size classification shown is based on ISO 25358. Droplet size classification standard is subject to change. Tabulations are based on spraying water at 70°F. See technical information (pages 179–202) for droplet size classification, useful formulas and other technical information.



### Typical Applications



**HERBICIDE**  
SOIL APPLIED  
**EXCELLENT**  
SYSTEMIC  
**VERY GOOD**



**FERTILIZER**  
BROADCAST  
**VERY GOOD**



**DRIFT CONTROL**  
**EXCELLENT**



### FEATURES

- Excellent spray distribution for uniform coverage along the boom.
- Spray tip design incorporates a pre-orifice to produce larger droplets for less drift.
- Large, round orifice reduces clogging.
- Available in seven VisiFlo® Stainless Steel (VS) and seven VisiFlo Polymer (VP) capacities.
- Can be used with 114445A-\*CELR Quick TeeJet® cap and gasket for automatic alignment. Reference page 118 for more information.

### SPRAY PATTERN

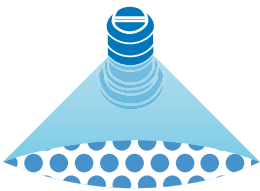

### DROPLET SIZE CLASSIFICATION

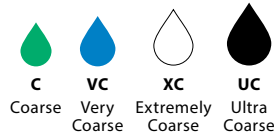

### OPTIMUM SPRAY HEIGHT

HEIGHT	SPACING
24**	20"
30**	30"
39**	40"

\*Wide angle spray nozzle height is influenced by nozzle orientation. The critical factor is to achieve a minimum 30% overlap.

### RECOMMENDED PRESSURE RANGE



### MATERIALS AVAILABLE

- VS** STAINLESS STEEL
- VP** POLYMER

### HOW TO ORDER

Stainless Steel with VisiFlo color-coding

T F - V S 4

Tip Material Capacity  
Type Code Size

Polymer with VisiFlo color-coding

T F - V P 4

Tip Material Capacity  
Type Code Size

# Turbo FloodJet® WIDE ANGLE FLAT SPRAY

TIP PART NO. (STRAINER MESH SIZE)	PSI	DROP SIZE		CAPACITY ONE TIP IN GPM	CAPACITY ONE TIP IN OZ/MIN	APPLICATION RATE FOR 40" SPRAY TIP SPACING								APPLICATION RATE FOR 20" SPRAY TIP SPACING			
		VS	VP			GALLONS PER ACRE (GPA)								TURF APPLICATION GALLONS PER 1000 SQ. FT.			
						4 MPH	5 MPH	6 MPH	8 MPH	10 MPH	12 MPH	15 MPH	20 MPH	2 MPH	3 MPH	4 MPH	5 MPH
TF-12 (50)	10	UC	UC	0.20	26	7.4	5.9	5.0	3.7	3.0	2.5	2.0	1.5	0.68	0.45	0.34	0.27
	20	XC	XC	0.28	36	10.4	8.3	6.9	5.2	4.2	3.5	2.8	2.1	0.95	0.63	0.48	0.38
	30	VC	VC	0.35	45	13.0	10.4	8.7	6.5	5.2	4.3	3.5	2.6	1.2	0.79	0.60	0.48
	40	VC	C	0.40	51	14.9	11.9	9.9	7.4	5.9	5.0	4.0	3.0	1.4	0.91	0.68	0.54
TF-12.5 (50)	10	UC	UC	0.25	32	9.3	7.4	6.2	4.6	3.7	3.1	2.5	1.9	0.85	0.57	0.43	0.34
	20	XC	XC	0.35	45	13.0	10.4	8.7	6.5	5.2	4.3	3.5	2.6	1.2	0.79	0.60	0.48
	30	VC	VC	0.43	55	16.0	12.8	10.6	8.0	6.4	5.3	4.3	3.2	1.5	0.97	0.73	0.58
	40	VC	C	0.50	64	18.6	14.9	12.4	9.3	7.4	6.2	5.0	3.7	1.7	1.1	0.85	0.68
TF-13 (50)	10	UC	UC	0.30	38	11.1	8.9	7.4	5.6	4.5	3.7	3.0	2.2	1.0	0.68	0.51	0.41
	20	XC	XC	0.42	54	15.6	12.5	10.4	7.8	6.2	5.2	4.2	3.1	1.4	0.95	0.71	0.57
	30	XC	VC	0.52	67	19.3	15.4	12.9	9.7	7.7	6.4	5.1	3.9	1.8	1.2	0.88	0.71
	40	VC	VC	0.60	77	22	17.8	14.9	11.1	8.9	7.4	5.9	4.5	2.0	1.4	1.0	0.82
TF-14 (50)	10	UC	UC	0.40	51	14.9	11.9	9.9	7.4	5.9	5.0	4.0	3.0	1.4	0.91	0.68	0.54
	20	UC	UC	0.57	73	21	16.9	14.1	10.6	8.5	7.1	5.6	4.2	1.9	1.3	0.97	0.78
	30	XC	XC	0.69	88	26	20	17.1	12.8	10.2	8.5	6.8	5.1	2.3	1.6	1.2	0.94
	40	VC	VC	0.80	102	30	24	19.8	14.9	11.9	9.9	7.9	5.9	2.7	1.8	1.4	1.1
TF-15	10	UC	UC	0.50	64	18.6	14.9	12.4	9.3	7.4	6.2	5.0	3.7	1.7	1.1	0.85	0.68
	20	UC	UC	0.71	91	26	21	17.6	13.2	10.5	8.8	7.0	5.3	2.4	1.6	1.2	0.97
	30	XC	XC	0.87	111	32	26	22	16.1	12.9	10.8	8.6	6.5	3.0	2.0	1.5	1.2
	40	VC	VC	1.00	128	37	30	25	18.6	14.9	12.4	9.9	7.4	3.4	2.3	1.7	1.4
TF-17.5	10	UC	UC	0.75	96	28	22	18.6	13.9	11.1	9.3	7.4	5.6	2.6	1.7	1.3	1.0
	20	UC	UC	1.06	136	39	31	26	19.7	15.7	13.1	10.5	7.9	3.6	2.4	1.8	1.4
	30	XC	XC	1.30	166	48	39	32	24	19.3	16.1	12.9	9.7	4.4	2.9	2.2	1.8
	40	VC	VC	1.50	192	56	45	37	28	22	18.6	14.9	11.1	5.1	3.4	2.6	2.0
TF-110	10	UC	UC	1.00	128	37	30	25	18.6	14.9	12.4	9.9	7.4	3.4	2.3	1.7	1.4
	20	UC	UC	1.41	180	52	42	35	26	21	17.4	14.0	10.5	4.8	3.2	2.4	1.9
	30	XC	XC	1.73	221	64	51	43	32	26	21	17.1	12.8	5.9	3.9	2.9	2.4
	40	VC	VC	2.00	256	74	59	50	37	30	25	19.8	14.9	6.8	4.5	3.4	2.7

**Note:** Always double check your application rates. Droplet size classification shown is based on ISO 25358. Droplet size classification standard is subject to change. Tabulations are based on spraying water at 70°F. See technical information (pages 179–202) for droplet size classification, useful formulas and other technical information. †Specify material.

## QCT CAM LEVER COUPLING ADAPTER

- Provides easy changeover from high capacity to lower capacity nozzles.
- Adapter fits standard 3/4" cam lever coupling.
- Corrosion-resistant stainless steel and polypropylene construction.
- Rated up to 100 PSI.
- Use QJT-NYB to retrofit to Quick TeeJet.





# Quick Turbo FloodJet® WIDE ANGLE FLAT SPRAY

BROADCAST NOZZLES

## Typical Applications



**HERBICIDE**  
SOIL APPLIED  
**EXCELLENT**



**DRIFT**  
**CONTROL**  
**EXCELLENT**



## FEATURES

- Turbulence chamber creates a dramatic improvement in pattern uniformity.
- Pre-orifice design produces larger droplets for reduced drift.
- Large, round orifice reduces clogging.
- 1.26" diameter tip body fits into 3/4" cam lever coupling.
- Grooved side molding for automatic alignment.

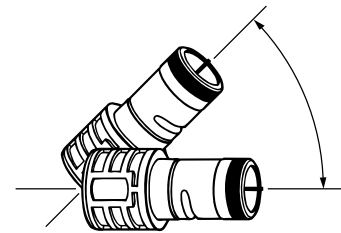

Nozzle can be mounted between 0° and 45°

## OPTIMUM SPRAY HEIGHT\*

HEIGHT	SPACING
40"	40"
60"	60"

\*When nozzle is mounted parallel to the ground.

## RECOMMENDED PRESSURE RANGE



## MATERIALS AVAILABLE

**VS** STAINLESS STEEL

## HOW TO ORDER

Stainless Steel with VisiFlo® color-coding

**Q C T F - V S 4 0**

Tip Type	Material Code	Capacity Size



TIP PART NO.	PSI	CAPACITY ONE TIP IN GPM	APPLICATION RATE FOR 60" SPRAY TIP SPACING (60" TYPICAL SPACING FOR LARGE CAPACITY NOZZLES)										
			4 MPH	5 MPH	6 MPH	7 MPH	8 MPH	9 MPH	10 MPH	12 MPH	14 MPH	16 MPH	18 MPH
QCTF-VS15	10	1.50	37	30	25	21	18.6	16.5	14.9	12.4	10.6	9.3	8.3
	20	2.12	52	42	35	30	26	23	21	17.5	15.0	13.1	11.7
	30	2.60	64	51	43	37	32	29	26	21	18.4	16.1	14.3
	40	3.00	74	59	50	42	37	33	30	25	21	18.6	16.5
QCTF-VS20	10	2.00	50	40	33	28	25	22	19.8	16.5	14.1	12.4	11.0
	20	2.83	70	56	47	40	35	31	28	23	20	17.5	15.6
	30	3.46	86	69	57	49	43	38	34	29	24	21	19.0
	40	4.00	99	79	66	57	50	44	40	33	28	25	22
QCTF-VS30	10	3.00	74	59	50	42	37	33	30	25	21	18.6	16.5
	20	4.24	105	84	70	60	52	47	42	35	30	26	23
	30	5.20	129	103	86	74	64	57	51	43	37	32	29
	40	6.00	149	119	99	85	74	66	59	50	42	37	33
QCTF-VS40	10	4.00	99	79	66	57	50	44	40	33	28	25	22
	20	5.66	140	112	93	80	70	62	56	47	40	35	31
	30	6.93	172	137	114	98	86	76	69	57	49	43	38
	40	8.00	198	158	132	113	99	88	79	66	57	50	44
QCTF-VS50	10	5.00	124	99	83	71	62	55	50	41	35	31	28
	20	7.07	175	140	117	100	87	78	70	58	50	44	39
	30	8.66	214	171	143	122	107	95	86	71	61	54	48
	40	10.00	248	198	165	141	124	110	99	83	71	62	55
QCTF-VS60	10	6.00	149	119	99	85	74	66	59	50	42	37	33
	20	8.49	210	168	140	120	105	93	84	70	60	53	47
	30	10.4	257	206	172	147	129	114	103	86	74	64	57
	40	12.0	297	238	198	170	149	132	119	99	85	74	66
QCTF-VS80	10	8.00	198	158	132	113	99	88	79	66	57	50	44
	20	11.3	280	224	186	160	140	124	112	93	80	70	62
	30	13.9	344	275	229	197	172	153	138	115	98	86	76
	40	16.0	396	317	264	226	198	176	158	132	113	99	88
QCTF-VS100	10	10.0	248	198	165	141	124	110	99	83	71	62	55
	20	14.1	349	279	233	199	174	155	140	116	100	87	78
	30	17.3	428	343	285	245	214	190	171	143	122	107	95
	40	20.0	495	396	330	283	248	220	198	165	141	124	110
QCTF-VS120	10	12.0	297	238	198	170	149	132	119	99	85	74	66
	20	17.0	421	337	281	240	210	187	168	140	120	105	94
	30	20.8	515	412	343	294	257	229	206	172	147	129	114
	40	24.0	594	475	396	339	297	264	238	198	170	149	132

**Note:** Always double check your application rates. Tabulations are based on spraying water at 70°F. See technical information (pages 179–202) for useful formulas and other technical information.

### RECOMMENDED PRESSURE RANGE



10-40 PSI

### MATERIALS AVAILABLE



VS STAINLESS STEEL



SS STAINLESS STEEL



VP POLYMER



B BRASS



TK-VP FloodJet



TK-VS FloodJet



(B)1/4K FloodJet  
(1/2" - 1" NPT)



QCK  
Quick FloodJet

TIP PART NO. (STRAINER MESH SIZE)	PSI	CAPACITY ONE TIP IN GPM	APPLICATION RATE FOR 40" SPRAY TIP SPACING							
			4 MPH	5 MPH	6 MPH	8 MPH	10 MPH	12 MPH	15 MPH	20 MPH
1/8K-.50 TK-.50 (100)	10	0.050	—	—	—	—	—	—	—	—
	20	0.071	2.6	2.1	1.8	1.3	1.1	0.88	0.70	0.53
	30	0.087	3.2	2.6	2.2	1.6	1.3	1.1	0.86	0.65
	40	0.10	3.7	3.0	2.5	1.9	1.5	1.2	0.99	0.74
1/8K-.75 TK-.75 (100)	10	0.075	2.8	2.2	1.9	1.4	1.1	0.93	0.74	0.56
	20	0.11	4.1	3.3	2.7	2.0	1.6	1.4	1.1	0.82
	30	0.13	4.8	3.9	3.2	2.4	1.9	1.6	1.3	0.97
	40	0.15	5.6	4.5	3.7	2.8	2.2	1.9	1.5	1.1
1/8K-1 TK-1 (100)	10	0.10	3.7	3.0	2.5	1.9	1.5	1.2	0.99	0.74
	20	0.14	5.2	4.2	3.5	2.6	2.1	1.7	1.4	1.0
	30	0.17	6.3	5.0	4.2	3.2	2.5	2.1	1.7	1.3
	40	0.20	7.4	5.9	5.0	3.7	3.0	2.5	2.0	1.5
1/8K-1.5 TK-1.5 (50)	10	0.15	5.6	4.5	3.7	2.8	2.2	1.9	1.5	1.1
	20	0.21	7.8	6.2	5.2	3.9	3.1	2.6	2.1	1.6
	30	0.26	9.7	7.7	6.4	4.8	3.9	3.2	2.6	1.9
	40	0.30	11.1	8.9	7.4	5.6	4.5	3.7	3.0	2.2
[1/8K, 1/4K, TK]-2 TK-2 (50)	10	0.20	7.4	5.9	5.0	3.7	3.0	2.5	2.0	1.5
	20	0.28	10.4	8.3	6.9	5.2	4.2	3.5	2.8	2.1
	30	0.35	13.0	10.4	8.7	6.5	5.2	4.3	3.5	2.6
	40	0.40	14.9	11.9	9.9	7.4	5.9	5.0	4.0	3.0
[1/8K, 1/4K, TK]-2.5 TK-2.5 (50)	10	0.25	9.3	7.4	6.2	4.6	3.7	3.1	2.5	1.9
	20	0.35	13.0	10.4	8.7	6.5	5.2	4.3	3.5	2.6
	30	0.43	16.0	12.8	10.6	8.0	6.4	5.3	4.3	3.2
	40	0.50	18.6	14.9	12.4	9.3	7.4	6.2	5.0	3.7
[1/8K, 1/4K, TK]-3 TK-3 (50)	10	0.30	11.1	8.9	7.4	5.6	4.5	3.7	3.0	2.2
	20	0.42	15.6	12.5	10.4	7.8	6.2	5.2	4.2	3.1
	30	0.52	19.3	15.4	12.9	9.7	7.7	6.4	5.1	3.9
	40	0.60	22	17.8	14.9	11.1	8.9	7.4	5.9	4.5
[1/8K, TK]-4 (50) TK-4 (50)	10	0.40	14.9	11.9	9.9	7.4	5.9	5.0	4.0	3.0
	20	0.57	21	16.9	14.1	10.6	8.5	7.1	5.6	4.2
	30	0.69	26	20	17.1	12.8	10.2	8.5	6.8	5.1
	40	0.80	30	24	19.8	14.9	11.9	9.9	7.9	5.9
[1/8K, 1/4K, TK]-5 TK-5 (50)	10	0.50	18.6	14.9	12.4	9.3	7.4	6.2	5.0	3.7
	20	0.71	26	21	17.6	13.2	10.5	8.8	7.0	5.3
	30	0.87	32	26	22	16.1	12.9	10.8	8.6	6.5
	40	1.00	37	30	25	18.6	14.9	12.4	9.9	7.4
[1/8K, 1/4K, TK]-7.5 TK-7.5 (50)	10	0.75	28	22	18.6	13.9	11.1	9.3	7.4	5.6
	20	1.06	39	31	26	19.7	15.7	13.1	10.5	7.9
	30	1.30	48	39	32	24	19.3	16.1	12.9	9.7
	40	1.50	56	45	37	28	22	18.6	14.9	11.1
[1/8K, 1/4K, TK]-10 TK-10 (50)	10	1.00	37	30	25	18.6	14.9	12.4	9.9	7.4
	20	1.41	52	42	35	26	21	17.4	14.0	10.5
	30	1.73	64	51	43	32	26	21	17.1	12.8
	40	2.00	74	59	50	37	30	25	19.8	14.9
[1/8K, 1/4K]-12 TK-12	10	1.20	45	36	30	22	17.8	14.9	11.9	8.9
	20	1.70	63	50	42	32	25	21	16.8	12.6
	30	2.08	77	62	51	39	31	26	21	15.4
	40	2.40	89	71	59	45	36	30	24	17.8
[1/8K, 1/4K]-15 TK-15	10	1.50	56	45	37	28	22	18.6	14.9	11.1
	20	2.12	79	63	52	39	31	26	21	15.7
	30	2.60	97	77	64	48	39	32	26	19.3
	40	3.00	111	89	74	56	45	37	30	22
[1/8K, 1/4K]-18 TK-18	10	1.80	67	53	45	33	27	22	17.8	13.4
	20	2.55	95	76	63	47	38	32	25	19
	30	3.12	116	93	77	58	46	39	31	23
	40	3.60	134	107	89	67	53	45	36	27
[1/8K, 1/4K]-20 TK-20 QCK-20	10	2.00	74	59	50	37	30	25	19.8	14.9
	20	2.83	105	84	70	53	42	35	28	21
	30	3.46	128	103	86	64	51	43	34	26
	40	4.00	149	119	99	74	59	50	40	30
1/4K-22 TK-22	10	2.20	82	65	54	41	33	27	22	16.3
	20	3.11	115	92	77	58	46	38	31	23
	30	3.81	141	113	94	71	57	47	38	28
	40	4.40	163	131	109	82	65	54	44	33
1/4K-24 TK-24	10	2.40	89	71	59	45	36	30	24	17.8
	20	3.39	126	101	84	63	50	42	34	25
	30	4.16	154	124	103	77	62	51	41	31
	40	4.80	178	143	119	89	71	59	48	36

**Note:** Always double check your application rates. Tabulations are based on spraying water at 70°F. See technical information (pages 179-202) for useful formulas and other technical information. Other spray angles, capacities, and materials may be available. See your TeeJet Dealer or [www.teejet.com](http://www.teejet.com) for more information. (B) = BSPT Thread

### HOW TO ORDER

Stainless Steel  
with VisiFlo® color-coding

**Q C K - S S 1 0 0**

Tip Type      Material Code      Capacity Size

**T K - V S 5**

Tip Type      Material Code      Capacity Size

Polymer with VisiFlo color-coding

**T K - V P 3**

Tip Type      Material Code      Capacity Size

Brass

**( B ) 1 / 4 K - 5**

BSPT Thread      Tip Type      Capacity Size

Stainless Steel

**( B ) 1 / 8 K - S S 5**

BSPT Thread      Tip Type      Material Code      Capacity Size

TIP PART NO.	PSI	CAPACITY ONE TIP IN GPM	APPLICATION RATE FOR 60" SPRAY TIP SPACING							
			4 MPH	5 MPH	6 MPH	8 MPH	10 MPH	12 MPH	15 MPH	20 MPH
1/4K-27	10	2.70	67	53	45	33	27	22	17.8	13.4
	20	3.82	95	76	63	47	38	32	25	18.9
	30	4.68	116	93	77	58	46	39	31	23
	40	5.40	134	107	89	67	53	45	36	27
3/8K-30 TK-30	10	3.00	74	59	50	37	30	25	19.8	14.9
	20	4.24	105	84	70	52	42	35	28	21
	30	5.20	129	103	86	64	51	43	34	26
	40	6.00	149	119	99	74	59	50	40	30
QCK-30	10	3.50	87	69	58	43	35	29	23	17.3
	20	4.95	123	98	82	61	49	41	33	25
	30	6.06	150	120	100	75	60	50	40	30
	40	7.00	173	139	116	87	69	58	46	35
3/8K-35	10	4.00	99	79	66	50	40	33	26	19.8
	20	5.66	140	112	93	70	56	47	37	28
	30	6.93	172	137	114	86	69	57	46	34
	40	8.00	198	158	132	99	79	66	53	40
[3/8K, 1/2K]-40	10	4.50	111	89	74	56	45	37	30	22
QCK-40	20	6.36	157	126	105	79	63	52	42	31
	30	7.79	193	154	129	96	77	64	51	39
	40	9.00	223	178	149	111	89	74	59	45
	10	5.00	124	99	83	62	50	41	33	25
1/2K-50	20	7.07	175	140	117	87	70	58	47	35
	30	8.66	214	171	143	107	86	71	57	43
	40	10.0	248	198	165	124	99	83	66	50
	10	6.00	149	119	99	74	59	50	40	30
QCK-50	20	8.49	210	168	140	105	84	70	56	42
	30	10.4	257	206	171	129	103	86	69	51
	40	12.0	297	238	198	149	119	99	79	59
	10	7.00	173	139	116	87	69	58	46	35
1/2K-70	20	9.90	245	196	163	123	98	82	65	49
	30	12.1	300	240	200	150	120	100	80	60
	40	14.0	347	277	231	173	139	116	92	69
	10	8.00	198	158	132	99	79	66	53	40
[1/2K, 3/4K]-80	20	11.3	280	224	186	140	112	93	75	56
	30	13.9	344	275	229	172	138	115	92	69
	40	16.0	396	317	264	198	158	132	106	79
	10	9.00	223	178	149	111	89	74	59	45
[1/2K, 3/4K]-90	20	12.7	314	251	210	157	126	105	84	63
	30	15.6	386	309	257	193	154	129	103	77
	40	18.0	446	356	297	223	178	149	119	89
	10	10.0	248	198	165	124	99	83	66	50
3/4K-100	20	14.1	349	279	233	174	140	116	93	70
	30	17.3	428	343	285	214	171	143	114	86
	40	20.0	495	396	330	248	198	165	132	99
	10	11.0	272	218	182	136	109	91	73	54
3/4K-110	20	15.6	386	309	257	193	154	129	103	77
	30	19.1	473	378	315	236	189	158	126	95
	40	22.0	545	436	363	272	218	182	145	109
	10	12.0	297	238	198	149	119	99	79	59
[1/2K, 3/4K]-120	20	17.0	421	337	281	210	168	140	112	84
	30	20.8	515	412	343	257	206	172	137	103
	40	24.0	594	475	396	297	238	198	158	119
	10	14.0	347	277	231	173	139	116	92	69
3/4K-140	20	19.8	490	392	327	245	196	163	131	98
	30	24.2	599	479	399	299	240	200	160	120
	40	28.0	693	554	462	347	277	231	185	139
	10	15.0	371	297	248	186	149	124	99	74
QCK-150	20	21.2	525	420	350	262	210	175	140	105
	30	26.0	644	515	429	322	257	215	172	129
	40	30.0	743	594	495	371	297	248	198	149
	10	16.0	396	317	264	198	158	132	106	79
3/4K-160	20	22.6	559	447	373	280	224	186	149	112
	30	27.7	686	548	457	343	274	229	183	137
	40	32.0	792	634	528	396	317	264	211	158
	10	18.0	446	356	297	223	178	149	119	89
3/4K-180	20	25.5	631	505	421	316	252	210	168	126
	30	31.2	772	618	515	386	309	257	206	154
	40	36.0	891	713	594	446	356	297	238	178
	10	21.0	520	416	347	260	208	173	139	104
3/4K-210	20	29.7	735	588	490	368	294	245	196	147
	30	36.4	901	721	601	450	360	300	240	180
	40	42.0	1040	832	693	520	416	347	277	208

**Note:** Always double check your application rates. Tabulations are based on spraying water at 70°F. See technical information (pages 179–202) for useful formulas and other technical information. Other spray angles, capacities, and materials may be available. See your TeeJet Dealer or [www.teejet.com](http://www.teejet.com) for more information.



**Typical Applications**



**HERBICIDE**  
SOIL APPLIED  
**EXCELLENT**  
SYSTEMIC  
**EXCELLENT**



**FERTILIZER**  
BROADCAST  
**EXCELLENT**



**DRIFT CONTROL**  
**EXCELLENT**



**FEATURES**

- Very large droplets.
- More precise flow and distribution pattern.
- Large orifice reduces clogging.
- 1/4TTJ(VS) is available in seven VisiFlo® capacities (02 to 15) and 1/4TTJ(VP) is available in four VisiFlo capacities (06 to 15).

**QJ4676-90-1/4-NYR**

- 90° fitting attaches to Quick TeeJet bodies—1/4" female threaded outlet.
- Simple installation of TurfJet nozzles on vertical nozzle bodies.
- Nylon construction.



**SPRAY PATTERN**

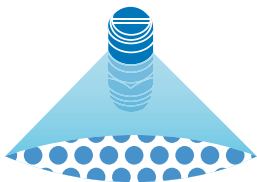

**DROPLET SIZE CLASSIFICATION**

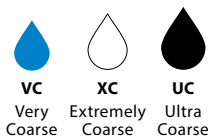

**OPTIMUM SPRAY HEIGHT**

HEIGHT	SPACING
24"*	20"
30"*	30"
39"*	40"

\*Wide angle spray nozzle height is influenced by nozzle orientation. The critical factor is to achieve a minimum 30% overlap.

**RECOMMENDED PRESSURE RANGE**

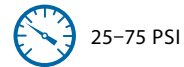

**MATERIALS AVAILABLE**



**HOW TO ORDER**

Stainless Steel with VisiFlo color-coding

**1 / 4 T T J 0 4 - V S**

Tip Type

Capacity Size

Material Code

Polymer with VisiFlo color-coding

**1 / 4 T T J 0 6 - V P**

Tip Type

Capacity Size

Material Code

TIP PART NO. (STRAINER MESH SIZE)	PSI	DROP SIZE	CAPACITY ONE NOZZLE IN GPM	CAPACITY ONE NOZZLE IN OZ/MIN	APPLICATION RATE FOR 40" SPRAY NOZZLE SPACING								APPLICATION RATE FOR 20" SPRAY TIP SPACING			
					GALLONS PER ACRE (GPA)								GALLONS PER 1000 SQ. FT.			
					4 MPH	5 MPH	6 MPH	8 MPH	10 MPH	12 MPH	15 MPH	20 MPH	2 MPH	3 MPH	4 MPH	5 MPH
1/4TTJ02 (50)	25	UC	0.16	20	5.9	4.8	4.0	3.0	2.4	2.0	1.6	1.2	0.54	0.36	0.27	0.22
	30	XC	0.17	22	6.3	5.0	4.2	3.2	2.5	2.1	1.7	1.3	0.58	0.39	0.29	0.23
	40	XC	0.20	26	7.4	5.9	5.0	3.7	3.0	2.5	2.0	1.5	0.68	0.45	0.34	0.27
	50	VC	0.22	28	8.2	6.5	5.4	4.1	3.3	2.7	2.2	1.6	0.75	0.50	0.37	0.30
	60	VC	0.24	31	8.9	7.1	5.9	4.5	3.6	3.0	2.4	1.8	0.82	0.54	0.41	0.33
1/4TTJ04 (50)	25	UC	0.32	41	11.9	9.5	7.9	5.9	4.8	4.0	3.2	2.4	1.1	0.73	0.54	0.44
	30	UC	0.35	45	13.0	10.4	8.7	6.5	5.2	4.3	3.5	2.6	1.2	0.79	0.60	0.48
	40	UC	0.40	51	14.9	11.9	9.9	7.4	5.9	5.0	4.0	3.0	1.4	0.91	0.68	0.54
	50	UC	0.45	58	16.7	13.4	11.1	8.4	6.7	5.6	4.5	3.3	1.5	1.0	0.77	0.61
	60	UC	0.49	63	18.2	14.6	12.1	9.1	7.3	6.1	4.9	3.6	1.7	1.1	0.83	0.67
1/4TTJ05 (50)	25	UC	0.40	51	14.9	11.9	9.9	7.4	5.9	5.0	4.0	3.0	1.4	0.91	0.68	0.54
	30	UC	0.43	55	16.0	12.8	10.6	8.0	6.4	5.3	4.3	3.2	1.5	0.97	0.73	0.58
	40	UC	0.50	64	18.6	14.9	12.4	9.3	7.4	6.2	5.0	3.7	1.7	1.1	0.85	0.68
	50	UC	0.56	72	21	16.6	13.9	10.4	8.3	6.9	5.5	4.2	1.9	1.3	0.95	0.76
	60	UC	0.61	78	23	18.1	15.1	11.3	9.1	7.5	6.0	4.5	2.1	1.4	1.0	0.83
1/4TTJ06 (50)	25	UC	0.47	60	17.4	14.0	11.6	8.7	7.0	5.8	4.7	3.5	1.6	1.1	0.80	0.64
	30	UC	0.52	67	19.3	15.4	12.9	9.7	7.7	6.4	5.1	3.9	1.8	1.2	0.88	0.71
	40	UC	0.60	77	22	17.8	14.9	11.1	8.9	7.4	5.9	4.5	2.0	1.4	1.0	0.82
	50	UC	0.67	86	25	19.9	16.6	12.4	9.9	8.3	6.6	5.0	2.3	1.5	1.1	0.91
	60	UC	0.73	93	27	22	18.1	13.6	10.8	9.0	7.2	5.4	2.5	1.7	1.2	0.99
1/4TTJ08	25	UC	0.63	81	23	18.7	15.6	11.7	9.4	7.8	6.2	4.7	2.1	1.4	1.1	0.86
	30	UC	0.69	88	26	20	17.1	12.8	10.2	8.5	6.8	5.1	2.3	1.6	1.2	0.94
	40	UC	0.80	102	30	24	19.8	14.9	11.9	9.9	7.9	5.9	2.7	1.8	1.4	1.1
	50	UC	0.89	114	33	26	22	16.5	13.2	11.0	8.8	6.6	3.0	2.0	1.5	1.2
	60	UC	0.98	125	36	29	24	18.2	14.6	12.1	9.7	7.3	3.3	2.2	1.7	1.3
1/4TTJ10	25	UC	0.79	101	29	23	19.6	14.7	11.7	9.8	7.8	5.9	2.7	1.8	1.3	1.1
	30	UC	0.87	111	32	26	22	16.1	12.9	10.8	8.6	6.5	3.0	2.0	1.5	1.2
	40	UC	1.00	128	37	30	25	18.6	14.9	12.4	9.9	7.4	3.4	2.3	1.7	1.4
	50	UC	1.12	143	42	33	28	21	16.6	13.9	11.1	8.3	3.8	2.5	1.9	1.5
	60	UC	1.22	156	45	36	30	23	18.1	15.1	12.1	9.1	4.1	2.8	2.1	1.7
1/4TTJ15	25	UC	1.19	152	44	35	29	22	17.7	14.7	11.8	8.8	4.0	2.7	2.0	1.6
	30	UC	1.30	166	48	39	32	24	19.3	16.1	12.9	9.7	4.4	2.9	2.2	1.8
	40	UC	1.50	192	56	45	37	28	22	18.6	14.9	11.1	5.1	3.4	2.6	2.0
	50	UC	1.68	215	62	50	42	31	25	21	16.6	12.5	5.7	3.8	2.9	2.3
	60	UC	1.84	236	68	55	46	34	27	23	18.2	13.7	6.3	4.2	3.1	2.5
75	UC	2.05	262	76	61	51	38	30	25	20	15.2	7.0	4.6	3.5	2.8	

**Note:** Always double check your application rates. Droplet size classification shown is based on ISO 25358. Droplet size classification standard is subject to change. Tabulations are based on spraying water at 70°F. See technical information (pages 179–202) for droplet size classification, useful formulas and other technical information.

## Typical Applications



**HERBICIDE**  
SOIL APPLIED  
**EXCELLENT**  
SYSTEMIC  
**EXCELLENT**



**FUNGICIDE**  
SYSTEMIC  
**EXCELLENT**



**INSECTICIDE**  
SYSTEMIC  
**EXCELLENT**



**FERTILIZER**  
BROADCAST  
**EXCELLENT**



**DRIFT CONTROL**  
**VERY GOOD**



## FEATURES

- Large droplets to reduce drift.
- Wide spray angle up to 120° allows use on 40" spacing.
- Can be used with 114445A\*-CEL R for Quick TeeJet® connection. Reference page 118 for more information.

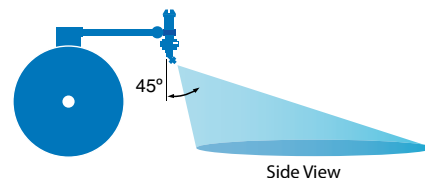

## SPRAY PATTERN

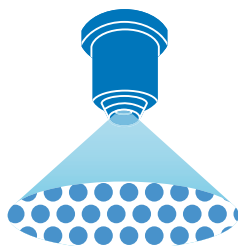

## OPTIMUM SPRAY HEIGHT

HEIGHT	SPACING
24**	20"
30**	30"
39**	40"

FullJet nozzles should be angled 30°–45° from vertical for uniform spray distribution.

\*Wide angle spray nozzle height is influenced by nozzle orientation. The critical factor is to achieve a minimum 30% overlap.

## RECOMMENDED PRESSURE RANGE



15–40 PSI

## MATERIALS AVAILABLE

**VS** STAINLESS STEEL

## HOW TO ORDER

Stainless Steel with VisiFlo® color-coding

**F L - 5 V S**

Tip Capacity Material  
Type Size Code

Celcon with Stainless Steel vane and VisiFlo color-coding

**F L - 5 V C**

Tip Capacity Material  
Type Size Code

# FullJet® WIDE ANGLE FULL CONE SPRAY

BROADCAST NOZZLES

TIP PART NO. (STRAINER MESH SIZE)	PSI	CAPACITY ONE TIP IN GPM	CAPACITY ONE TIP IN OZ/MIN	APPLICATION RATE FOR 40" SPRAY TIP SPACING							APPLICATION RATE FOR 20" SPRAY TIP SPACING			
				GALLONS PER ACRE (GPA)							TURF APPLICATION GALLONS PER 1000 SQ. FT.			
				4 MPH	5 MPH	6 MPH	8 MPH	10 MPH	12 MPH	15 MPH	2 MPH	3 MPH	4 MPH	5 MPH
FL-5	15	0.34	44	16.8	12.6	10.1	8.4	7.2	6.3	5.0	1.2	0.77	0.58	0.46
	20	0.38	49	18.8	14.1	11.3	9.4	8.1	7.1	5.6	1.3	0.86	0.65	0.52
	30	0.46	59	23	17.1	13.7	11.4	9.8	8.5	6.8	1.6	1.0	0.78	0.63
	40	0.50	64	25	18.6	14.9	12.4	10.6	9.3	7.4	1.7	1.1	0.85	0.68
FL-6.5	15	0.42	54	21	15.6	12.5	10.4	8.9	7.8	6.2	1.4	0.95	0.71	0.57
	20	0.48	61	24	17.8	14.3	11.9	10.2	8.9	7.1	1.6	1.1	0.82	0.65
	30	0.57	73	28	21	16.9	14.1	12.1	10.6	8.5	1.9	1.3	0.97	0.78
	40	0.65	83	32	24	19.3	16.1	13.8	12.1	9.7	2.2	1.5	1.1	0.88
FL-8	15	0.51	65	25	18.9	15.1	12.6	10.8	9.5	7.6	1.7	1.2	0.87	0.69
	20	0.58	74	29	22	17.2	14.4	12.3	10.8	8.6	2.0	1.3	0.99	0.79
	30	0.70	90	35	26	21	17.3	14.9	13.0	10.4	2.4	1.6	1.2	0.95
	40	0.80	102	40	30	24	19.8	17.0	14.9	11.9	2.7	1.8	1.4	1.1
FL-10	15	0.67	86	33	25	19.9	16.6	14.2	12.4	9.9	2.3	1.5	1.1	0.91
	20	0.76	97	38	28	23	18.8	16.1	14.1	11.3	2.6	1.7	1.3	1.0
	30	0.91	116	45	34	27	23	19.3	16.9	13.5	3.1	2.1	1.5	1.2
	40	1.00	128	50	37	30	25	21	18.6	14.9	3.4	2.3	1.7	1.4
FL-15	15	0.97	124	48	36	29	24	21	18.0	14.4	3.3	2.2	1.6	1.3
	20	1.11	142	55	41	33	27	24	21	16	3.8	2.5	1.9	1.5
	30	1.32	169	65	49	39	33	28	25	20	4.5	3.0	2.2	1.8
	40	1.50	192	74	56	45	37	32	28	22	5.1	3.4	2.6	2.0

**Note:** Always double check your application rates. Tabulations are based on spraying water at 70°F. See technical information (pages 179–202) for useful formulas and other technical information.

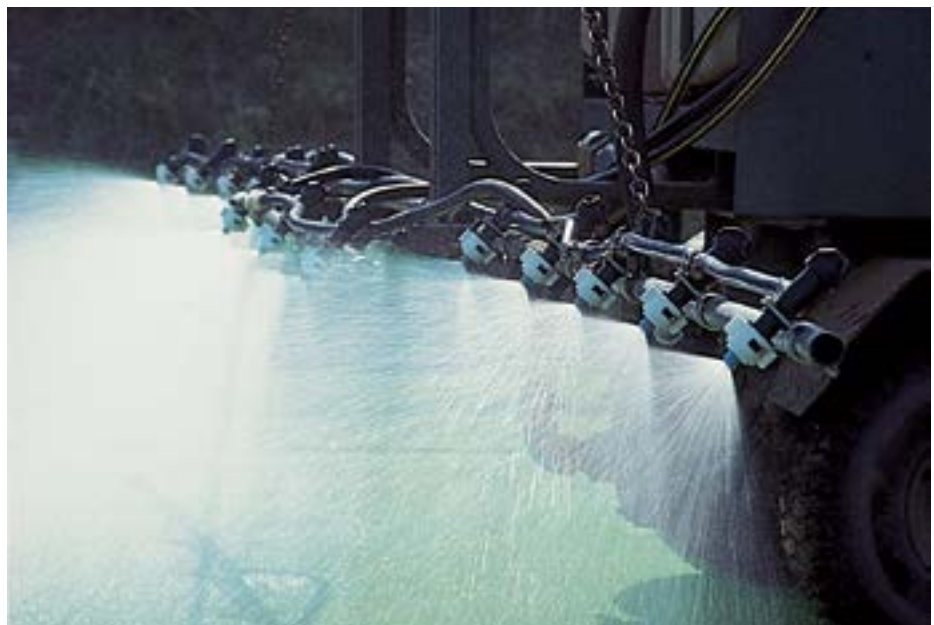



## 150° SERIES STAINLESS STEEL AND BRASS

Suggested for post-directed application with hose drops.

### SPRAY PATTERN

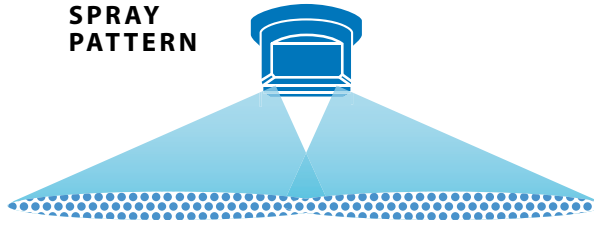

TIP PART NO. (STRAINER MESH SIZE)	PSI	CAPACITY ONE TIP IN GPM	APPLICATION RATE FOR 20" SPRAY TIP SPACING										
			GALLONS PER ACRE (GPA)										
			4 MPH	5 MPH	6 MPH	7 MPH	8 MPH	9 MPH	10 MPH	12 MPH	14 MPH	16 MPH	18 MPH
TQ150-01-SS (100)	20	0.071	5.3	4.2	3.5	3.0	2.6	2.3	2.1	1.8	1.5	1.3	1.2
	25	0.079	5.9	4.7	3.9	3.4	2.9	2.6	2.3	2.0	1.7	1.5	1.3
	30	0.087	6.5	5.2	4.3	3.7	3.2	2.9	2.6	2.2	1.8	1.6	1.4
	40	0.10	7.4	5.9	5.0	4.2	3.7	3.3	3.0	2.5	2.1	1.9	1.7
	50	0.11	8.2	6.5	5.4	4.7	4.1	3.6	3.3	2.7	2.3	2.0	1.8
TQ150-015-SS (100)	20	0.11	8.2	6.5	5.4	4.7	4.1	3.6	3.3	2.7	2.3	2.0	1.8
	25	0.12	8.9	7.1	5.9	5.1	4.5	4.0	3.6	3.0	2.5	2.2	2.0
	30	0.13	9.7	7.7	6.4	5.5	4.8	4.3	3.9	3.2	2.8	2.4	2.1
	40	0.15	11.1	8.9	7.4	6.4	5.6	5.0	4.5	3.7	3.2	2.8	2.5
	50	0.17	12.6	10.1	8.4	7.2	6.3	5.6	5.0	4.2	3.6	3.2	2.8
TQ150-02-SS (100)	20	0.14	10.4	8.3	6.9	5.9	5.2	4.6	4.2	3.5	3.0	2.6	2.3
	25	0.16	11.9	9.5	7.9	6.8	5.9	5.3	4.8	4.0	3.4	3.0	2.6
	30	0.17	12.6	10.1	8.4	7.2	6.3	5.6	5.0	4.2	3.6	3.2	2.8
	40	0.20	14.9	11.9	9.9	8.5	7.4	6.6	5.9	5.0	4.2	3.7	3.3
	50	0.22	16.3	13.1	10.9	9.3	8.2	7.3	6.5	5.4	4.7	4.1	3.6
TQ150-03-SS (100)	20	0.21	15.6	12.5	10.4	8.9	7.8	6.9	6.2	5.2	4.5	3.9	3.5
	25	0.24	17.8	14.3	11.9	10.2	8.9	7.9	7.1	5.9	5.1	4.5	4.0
	30	0.26	19.3	15.4	12.9	11.0	9.7	8.6	7.7	6.4	5.5	4.8	4.3
	40	0.30	22	17.8	14.9	12.7	11.1	9.9	8.9	7.4	6.4	5.6	5.0
	50	0.34	25	20	16.8	14.4	12.6	11.2	10.1	8.4	7.2	6.3	5.6
TQ150-04-SS (50)	20	0.28	21	16.6	13.9	11.9	10.4	9.2	8.3	6.9	5.9	5.2	4.6
	25	0.32	24	19.0	15.8	13.6	11.9	10.6	9.5	7.9	6.8	5.9	5.3
	30	0.35	26	21	17.3	14.9	13.0	11.6	10.4	8.7	7.4	6.5	5.8
	40	0.40	30	24	19.8	17.0	14.9	13.2	11.9	9.9	8.5	7.4	6.6
	50	0.45	33	27	22	19.1	16.7	14.9	13.4	11.1	9.5	8.4	7.4
TQ150-05-SS (50)	20	0.35	26	21	17.3	14.9	13.0	11.6	10.4	8.7	7.4	6.5	5.8
	25	0.40	30	24	19.8	17.0	14.9	13.2	11.9	9.9	8.5	7.4	6.6
	30	0.43	32	26	21	18.2	16.0	14.2	12.8	10.6	9.1	8.0	7.1
	40	0.50	37	30	25	21	18.6	16.5	14.9	12.4	10.6	9.3	8.3
	50	0.56	42	33	28	24	21	18.5	16.6	13.9	11.9	10.4	9.2
TQ150-06-SS (50)	20	0.42	31	25	21	17.8	15.6	13.9	12.5	10.4	8.9	7.8	6.9
	25	0.47	35	28	23	19.9	17.4	15.5	14.0	11.6	10.0	8.7	7.8
	30	0.52	39	31	26	22	19.3	17.2	15.4	12.9	11.0	9.7	8.6
	40	0.60	45	36	30	25	22	19.8	17.8	14.9	12.7	11.1	9.9
	50	0.67	50	40	33	28	25	22	19.9	16.6	14.2	12.4	11.1
TQ150-08-SS (50)	20	0.57	42	34	28	24	21	18.8	16.9	14.1	12.1	10.6	9.4
	25	0.63	47	37	31	27	23	21	18.7	15.6	13.4	11.7	10.4
	30	0.69	51	41	34	29	26	23	20	17.1	14.6	12.8	11.4
	40	0.80	59	48	40	34	30	26	24	19.8	17.0	14.9	13.2
	50	0.89	66	53	44	38	33	29	26	22	18.9	16.5	14.7
TQ150-09-SS (50)	20	0.64	48	38	32	27	24	21	19.0	15.8	13.6	11.9	10.6
	25	0.71	53	42	35	30	26	23	21	17.6	15.1	13.2	11.7
	30	0.78	58	46	39	33	29	26	23	19.3	16.5	14.5	12.9
	40	0.90	67	53	45	38	33	30	27	22	19.1	16.7	14.9
	50	1.01	75	60	50	43	37	33	30	25	21	18.7	16.7

**Note:** Always double check your application rates. Tabulations are based on spraying water at 70°F. See technical information (pages 179–202) for useful formulas and other technical information.

### RECOMMENDED PRESSURE RANGE



20–50 PSI

### MATERIALS AVAILABLE

**SS** STAINLESS STEEL

**B** BRASS

### HOW TO ORDER

Stainless Steel

T Q 1 5 0 - 0 3 - S S

Tip Type

Capacity Size

Material Code

Brass

T Q 1 5 0 - 0 1

Tip Type

Capacity Size



# OFF-CENTER FLAT SPRAY (SMALLER CAPACITIES)

TeeJet Off-Center spray tips are commonly installed in double and single swivel nozzle bodies. Because these bodies are adjustable for angular position, a wide spray swath is easily obtained.

See page 140 for swivels and hose drops.

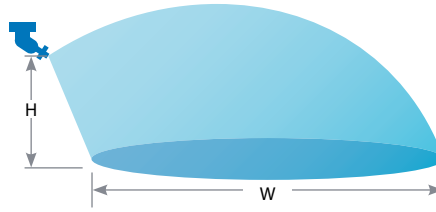

BROADCAST NOZZLES

TIP PART NO. (STRAINER MESH SIZE)	PSI	CAPACITY ONE TIP IN GPM	HEIGHT = 18"				HEIGHT = 24"					
			"W" INCHES	GALLONS PER ACRE (GPA)				"W" INCHES	GALLONS PER ACRE (GPA)			
				3 MPH	4 MPH	5 MPH	6 MPH		3 MPH	4 MPH	5 MPH	6 MPH
OC-01 (100)	30	0.087	58	3.0	2.2	1.8	1.5	65	2.7	2.0	1.6	1.3
	40	0.10	60	3.3	2.5	2.0	1.7	67	3.0	2.2	1.8	1.5
	60	0.12	62	3.8	2.9	2.3	1.9	69	3.4	2.6	2.1	1.7
OC-02 (50)	30	0.17	68	5.0	3.7	3.0	2.5	75	4.5	3.4	2.7	2.2
	40	0.20	70	5.7	4.2	3.4	2.8	77	5.1	3.9	3.1	2.6
	60	0.24	72	6.6	5.0	4.0	3.3	78	6.1	4.6	3.7	3.0
OC-03 (50)	30	0.26	77	6.7	5.0	4.0	3.3	80	6.4	4.8	3.9	3.2
	40	0.30	80	7.4	5.6	4.5	3.7	83	7.2	5.4	4.3	3.6
	60	0.37	82	8.9	6.7	5.4	4.5	85	8.6	6.5	5.2	4.3
OC-04 (50)	30	0.35	91	7.6	5.7	4.6	3.8	93	7.5	5.6	4.5	3.7
	40	0.40	93	8.5	6.4	5.1	4.3	94	8.4	6.3	5.1	4.2
	60	0.49	94	10.3	7.7	6.2	5.2	95	10.2	7.7	6.1	5.1
OC-06 (50)	30	0.52	99	10.4	7.8	6.2	5.2	108	9.5	7.2	5.7	4.8
	40	0.60	101	11.8	8.8	7.1	5.9	110	10.8	8.1	6.5	5.4
	60	0.73	102	14.2	10.6	8.5	7.1	111	13.0	9.8	7.8	6.5
OC-08 (50)	30	0.69	100	13.7	10.2	8.2	6.8	110	12.4	9.3	7.5	6.2
	40	0.80	102	15.5	11.6	9.3	7.8	112	14.1	10.6	8.5	7.1
	60	0.98	104	18.7	14.0	11.2	9.3	113	17.2	12.9	10.3	8.6
OC-12	30	1.04	102	20	15.1	12.1	10.1	113	18.2	13.7	10.9	9.1
	40	1.20	104	23	17.1	13.7	11.4	115	21	15.5	12.4	10.3
	60	1.47	105	28	21	16.6	13.9	116	25	18.8	15.1	12.5
OC-16	30	1.39	132	21	15.6	12.5	10.4	142	19.4	14.5	11.6	9.7
	40	1.60	138	23	17.2	13.8	11.5	146	22	16.3	13.0	10.8
	60	1.96	143	27	20	16.3	13.6	148	26	19.7	15.7	13.1

**Note:** Always double check your application rates. Tabulations are based on spraying water at 70°F. See technical information (pages 179–202) for useful formulas and other technical information.

## RECOMMENDED PRESSURE RANGE



30–60 PSI

## MATERIALS AVAILABLE



STAINLESS STEEL



BRASS

## HOW TO ORDER

Brass

OC - 0 2

Tip Type

Capacity Size

Stainless Steel

OC - S S 0 6

Tip Type

Material Code

Capacity Size

## Typical Applications



**HERBICIDE**  
SOIL APPLIED  
**EXCELLENT**  
SYSTEMIC  
**EXCELLENT**



**FERTILIZER**  
BROADCAST  
**EXCELLENT**



**DRIFT CONTROL**  
**EXCELLENT**



## FEATURES

- Unique orifice geometry produces a wide spray pattern while maintaining superior distribution across entire width.
- Pre-orifice design minimizes drift.
- Extra wide spray pattern—up to 18.5'—using a single nozzle.
- Removable polymer pre-orifice.
- NPT or BSPT (male) threads for easy installation.

**Mounting Note:** Position nozzle horizontal to ground with spray pattern down and to the side.

## SPRAY PATTERN

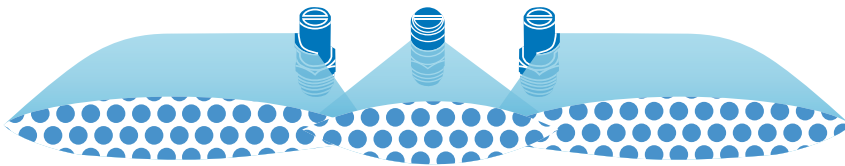

**Note:** The addition of the middle nozzle is one option of configuration. XP BoomJet can be used with TurfJet (1/4TTJ) found on pages 52–53.

## DROPLET SIZE CLASSIFICATION

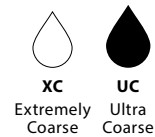

## RECOMMENDED PRESSURE RANGE



## MATERIALS AVAILABLE



## HOW TO ORDER

Polymer with VisiFlo® color-coding  
**( B ) 1 / 2 X P 8 0 L ( R ) - V P**

BSPT Thread	Tip Type	Capacity Size	Left or Right Boom Spray	Material Code
-------------	----------	---------------	--------------------------	---------------

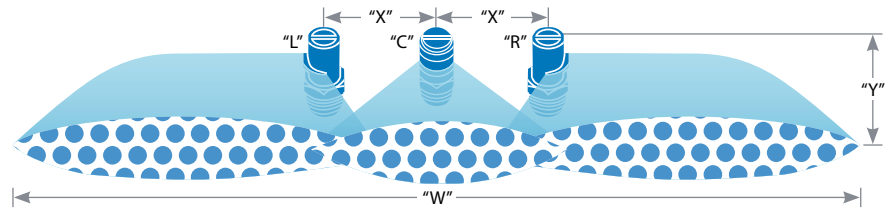

**"X" = APPLICATION RATE FOR 20" SPRAY NOZZLE SPACING**

TIP PART NO. "R", "L"	CENTER NOZZLE "C"	PSI	DROP SIZE	CAPACITY THREE NOZZLES IN GPM	SPRAY WIDTH "W" (FEET)		HEIGHT "Y" = 24"										HEIGHT "Y" = 36"									
					24" HEIGHT	36" HEIGHT	GALLONS PER ACRE (GPA) FOR THREE NOZZLES					TURF APPLICATION GALLONS PER 1000 SQ. FT.					GALLONS PER ACRE (GPA) FOR THREE NOZZLES					TURF APPLICATION GALLONS PER 1000 SQ. FT.				
							4 MPH	6 MPH	8 MPH	10 MPH	15 MPH	20 MPH	2 MPH	3 MPH	4 MPH	5 MPH	4 MPH	6 MPH	8 MPH	10 MPH	15 MPH	20 MPH	2 MPH	3 MPH	4 MPH	5 MPH
							MPH	MPH	MPH	MPH	MPH	MPH	MPH	MPH	MPH	MPH	MPH	MPH	MPH	MPH	MPH	MPH	MPH	MPH	MPH	MPH
(B)1/4XP10R (B)1/4XP10L	1/4TTJ08	30 UC	2.43	23.3	25.3	12.9	8.6	6.5	5.2	3.4	2.6	0.59	0.39	0.30	0.24	11.9	7.9	5.9	4.8	3.2	2.4	0.54	0.36	0.27	0.22	
		40 XC	2.80	25.3	28.3	13.7	9.1	6.8	5.5	3.7	2.7	0.63	0.42	0.31	0.25	12.2	8.2	6.1	4.9	3.3	2.4	0.56	0.37	0.28	0.22	
		50 XC	3.13	28.3	30.3	13.7	9.1	6.8	5.5	3.6	2.7	0.63	0.42	0.31	0.25	12.8	8.5	6.4	5.1	3.4	2.6	0.59	0.39	0.29	0.23	
(B)1/4XP20R (B)1/4XP20L	1/4TTJ08	30 UC	4.19	26.3	27.3	19.7	13.1	9.9	7.9	5.3	3.9	0.90	0.60	0.45	0.36	19.0	12.7	9.5	7.6	5.1	3.8	0.87	0.58	0.43	0.35	
		40 UC	4.80	30.3	31.3	19.6	13.1	9.8	7.8	5.2	3.9	0.90	0.60	0.45	0.36	19.0	12.7	9.5	7.6	5.1	3.8	0.87	0.58	0.43	0.35	
		50 XC	5.39	32.3	33.3	21	13.8	10.3	8.3	5.5	4.1	0.95	0.63	0.47	0.38	20	13.4	10.0	8.0	5.3	4.0	0.92	0.61	0.46	0.37	
(B)1/4XP25R (B)1/4XP25L	1/4TTJ10	30 UC	5.13	27.3	30.3	23	15.5	11.6	9.3	6.2	4.7	1.1	0.71	0.53	0.43	21	14.0	10.5	8.4	5.6	4.2	0.96	0.64	0.48	0.38	
		40 UC	6.00	30.3	32.3	25	16.3	12.3	9.8	6.5	4.9	1.1	0.75	0.56	0.45	23	15.3	11.5	9.2	6.1	4.6	1.1	0.70	0.53	0.42	
		50 XC	6.62	32.3	33.3	25	16.9	12.7	10.1	6.8	5.1	1.2	0.77	0.58	0.46	25	16.4	12.3	9.8	6.6	4.9	1.1	0.75	0.56	0.45	
(B)1/2XP40R (B)1/2XP40L	1/4TTJ15	30 UC	8.36	29.3	32.3	35	24	17.7	14.1	9.4	7.1	1.6	1.1	0.81	0.65	32	21	16.0	12.8	8.5	6.4	1.5	0.98	0.73	0.59	
		40 UC	9.50	31.3	34.3	38	25	18.8	15.0	10.0	7.5	1.7	1.1	0.86	0.69	34	23	17.1	13.7	9.1	6.9	1.6	1.0	0.78	0.63	
		50 UC	10.8	33.3	35.3	40	27	20	16.1	10.7	8.0	1.8	1.2	0.92	0.74	38	25	18.9	15.1	10.1	7.6	1.7	1.2	0.87	0.69	
60 UC	11.8	35.3	38.3	41	28	21	16.5	11.0	8.3	1.9	1.3	0.95	0.76	38	25	19.1	15.3	10.2	7.6	1.7	1.2	0.87	0.70			

**Note:** Always double check your application rates. Droplet size classification shown is based on ISO 25358. Droplet size classification standard is subject to change. Tabulations are based on spraying water at 70°F. See technical information (pages 179–202) for droplet size classification, useful formulas and other technical information. When XP BoomJet is combined with 1/4TTJ nozzle the minimum pressure used must be 30 PSI.

(B)=BSPT

For lower chart only, application rates are identical for a two-tip setup. Swath width and flow capacity will be doubled for a two-tip setup.

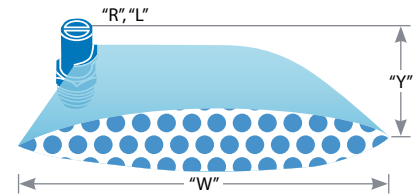

TIP PART NO.	PSI	DROP SIZE	CAPACITY ONE NOZZLE IN GPM	SPRAY WIDTH "W" (FEET)		HEIGHT "Y" = 24"										HEIGHT "Y" = 36"									
				24" HEIGHT	36" HEIGHT	GALLONS PER ACRE (GPA) FOR ONE NOZZLE					TURF APPLICATION GALLONS PER 1000 SQ. FT.					GALLONS PER ACRE (GPA) FOR ONE NOZZLE					TURF APPLICATION GALLONS PER 1000 SQ. FT.				
						4 MPH	6 MPH	8 MPH	10 MPH	15 MPH	20 MPH	2 MPH	3 MPH	4 MPH	5 MPH	4 MPH	6 MPH	8 MPH	10 MPH	15 MPH	20 MPH	2 MPH	3 MPH	4 MPH	5 MPH
						MPH	MPH	MPH	MPH	MPH	MPH	MPH	MPH	MPH	MPH	MPH	MPH	MPH	MPH	MPH	MPH	MPH	MPH	MPH	MPH
(B)1/4XP10R (B)1/4XP10L	20 UC	0.71	8.5	10.0	10.3	6.9	5.2	4.1	2.8	2.1	0.47	0.32	0.24	0.19	8.8	5.9	4.4	3.5	2.3	1.8	0.40	0.27	0.20	0.16	
	30 UC	0.87	10.0	11.0	10.8	7.2	5.4	4.3	2.9	2.2	0.49	0.33	0.25	0.20	9.8	6.5	4.9	3.9	2.6	2.0	0.45	0.30	0.22	0.18	
	40 XC	1.00	11.0	12.5	11.3	7.5	5.6	4.5	3.0	2.3	0.52	0.34	0.26	0.21	9.9	6.6	5.0	4.0	2.6	2.0	0.45	0.30	0.23	0.18	
	50 XC	1.12	12.5	13.5	11.1	7.4	5.5	4.4	3.0	2.2	0.51	0.34	0.25	0.20	10.3	6.8	5.1	4.1	2.7	2.1	0.47	0.31	0.24	0.19	
(B)1/4XP20R (B)1/4XP20L	20 UC	1.42	9.0	11.0	19.5	13.0	9.8	7.8	5.2	3.9	0.89	0.60	0.45	0.36	16.0	10.7	8.0	6.4	4.3	3.2	0.73	0.49	0.37	0.29	
	30 UC	1.75	11.5	12.0	18.8	12.6	9.4	7.5	5.0	3.8	0.86	0.57	0.43	0.34	18.0	12.0	9.0	7.2	4.8	3.6	0.83	0.55	0.41	0.33	
	40 UC	2.00	13.5	14.0	18.3	12.2	9.2	7.3	4.9	3.7	0.84	0.56	0.42	0.34	17.7	11.8	8.8	7.1	4.7	3.5	0.81	0.54	0.40	0.32	
	50 XC	2.25	14.5	15.0	19.2	12.8	9.6	7.7	5.1	3.8	0.88	0.59	0.44	0.35	18.6	12.4	9.3	7.4	5.0	3.7	0.85	0.57	0.43	0.34	
(B)1/4XP25R (B)1/4XP25L	20 UC	1.74	10.5	11.0	21	13.7	10.3	8.2	5.5	4.1	0.94	0.63	0.47	0.38	19.6	13.1	9.8	7.8	5.2	3.9	0.90	0.60	0.45	0.36	
	30 UC	2.13	12.0	13.5	22	14.6	11.0	8.8	5.9	4.4	1.0	0.67	0.50	0.40	19.5	13.0	9.8	7.8	5.2	3.9	0.89	0.60	0.45	0.36	
	40 UC	2.50	13.5	14.5	23	15.3	11.5	9.2	6.1	4.6	1.0	0.70	0.52	0.42	21	14.2	10.7	8.5	5.7	4.3	0.98	0.65	0.49	0.39	
	50 XC	2.75	14.5	15.0	23	15.6	11.7	9.4	6.3	4.7	1.1	0.72	0.54	0.43	23	15.1	11.3	9.1	6.1	4.5	1.0	0.69	0.52	0.42	
(B)1/2XP40R (B)1/2XP40L	20 UC	3.00	15.0	16.0	25	16.5	12.4	9.9	6.6	5.0	1.1	0.76	0.57	0.45	23	15.5	11.6	9.3	6.2	4.6	1.1	0.71	0.53	0.43	
	30 UC	2.87	11.0	12.0	32	22	16.1	12.9	8.6	6.5	1.5	0.99	0.74	0.59	30	19.7	14.8	11.8	7.9	5.9	1.4	0.90	0.68	0.54	
	40 UC	3.53	13.0	14.5	34	22	16.8	13.4	9.0	6.7	1.5	1.0	0.77	0.62	30	20	15.1	12.1	8.0	6.0	1.4	0.92	0.69	0.55	
	50 UC	4.00	14.0	15.5	35	24	17.7	14.1	9.4	7.1	1.6	1.1	0.81	0.65	32	21	16.0	12.8	8.5	6.4	1.5	0.97	0.73	0.58	
(B)1/2XP80R (B)1/2XP80L	20 UC	5.60	13.0	15.5	53	36	27	21	14.2	10.7	2.4	1.6	1.2	0.98	45	30	22	17.9	11.9	8.9	2.0	1.4	1.0	0.82	
	30 UC	6.83	15.0	16.5	56	38	28	23	15.0	11.3	2.6	1.7	1.3	1.0	51	34	26	20	13.7	10.2	2.3	1.6	1.2	0.94	
	40 UC	8.00	16.0	17.5	62	41	31	25	16.5	12.4	2.8	1.9	1.4	1.1	57	38	28	23	15.1	11.3	2.6	1.7	1.3	1.0	
	50 UC	8.73	16.5	18.0	65	44	33	26	17.5	13.1	3.0	2.0	1.5	1.2	60	40	30	24	16.0	12.0	2.7	1.8	1.4	1.1	
60 UC	9.60	17.5	18.5	68	45	34	27	18.1	13.6	3.1	2.1	1.6	1.2	64	43	32	26	17.1	12.8	2.9	2.0	1.5	1.2		

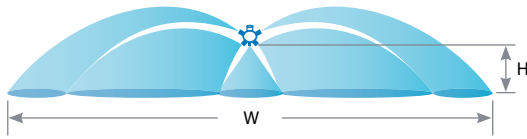

W = Maximum effective coverage with nozzle mounted at 36" height.



**5880-3/4 NPT Female**  
Back inlet connection.



**5430-3/4 NPT**

BOOMLESS NOZZLES

TIP PART NO.	OC (2)	H1 (2)	H1 (1)	PSI	GPM	"W" (FEET)	GALLONS PER ACRE (GPA)					TURF APPLICATION GALLONS PER 1000 SQ. FT.			
							4 MPH	5 MPH	7.5 MPH	10 MPH	15 MPH	2 MPH	3 MPH	4 MPH	5 MPH
5430-3/4-2TOC06 5880-3/4-2TOC06	6733-OC06	H1/4VV-1506	H1/4VVL-9502 with 50 mesh strainer	20	1.84	33.5	6.8	5.4	3.6	2.7	1.8	0.31	0.21	0.16	0.12
				30	2.25	34	8.2	6.6	4.4	3.3	2.2	0.38	0.25	0.19	0.15
				40	2.60	34.5	9.3	7.5	5.0	3.7	2.5	0.43	0.28	0.21	0.17
5430-3/4-2TOC10 5880-3/4-2TOC10	OC-10	H1/4U-0508HE	H1/4VVL-11004 with 50 mesh strainer	20	2.83	39.5	8.9	7.1	4.7	3.5	2.4	0.41	0.27	0.20	0.16
				30	3.46	40	10.7	8.6	5.7	4.3	2.9	0.49	0.33	0.25	0.20
				40	4.00	40.5	12.2	9.8	6.5	4.9	3.3	0.56	0.37	0.28	0.22
5430-3/4-2TOC20 5880-3/4-2TOC20	OC-20	H1/4U-0520HE	H1/4VVL-9506 with 50 mesh strainer	20	6.08	47	16.0	12.8	8.5	6.4	4.3	0.73	0.49	0.37	0.29
				30	7.45	50	18.4	14.8	9.8	7.4	4.9	0.84	0.56	0.42	0.34
				40	8.60	52	20	16.4	10.9	8.2	5.5	0.94	0.62	0.47	0.37
5430-3/4-2TOC40 5880-3/4-2TOC40	OC-40	H1/4U-0540HE	H1/4U-9510	20	12.0	56	27	21	14.1	10.6	7.1	1.2	0.81	0.61	0.49
				30	14.7	60	30	24	16.2	12.1	8.1	1.4	0.93	0.69	0.56
				40	17.0	63	33	27	17.8	13.4	8.9	1.5	1.0	0.76	0.61

**Note:** Always double check your application rates. Tabulations are based on spraying water at 70°F. See technical information (pages 179–202) for useful formulas and other technical information.

### HOW TO ORDER

5 8 8 0 - 3 / 4 - 2 T O C 0 6

## SWIVEL SPRAY NOZZLES WITH OFF-CENTER FLAT SPRAY – LARGER CAPACITIES

### EXTRA-WIDE FLAT SPRAY COVERAGE

W = Maximum effective coverage with nozzle mounted at 36" height.

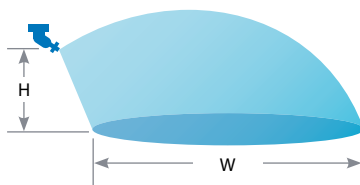

### HOW TO ORDER

4 6 2 9 - 3 / 4 - T O C 1 0  
Brass



**Type 4629-3/4-TOC Single Swivel**  
with 3/4" NPT (F) pipe connection. Brass.



**Type 4418-3/4-2TOC Double Swivel**  
with 3/4" NPT (F) pipe connection. Brass.

TIP PART NO.	PSI	GPM	"W" (FEET)	HEIGHT = 36"		
				GALLONS PER ACRE (GPA)		
				5 MPH	10 MPH	15 MPH
4629-3/4-TOC10	30	0.87	18	4.8	2.4	1.6
	40	1.00	18.5	5.4	2.7	1.8
	60	1.22	18.5	6.5	3.3	2.2
4629-3/4-TOC20	30	1.73	23.5	7.3	3.6	2.4
	40	2.00	24.5	8.1	4.0	2.7
	60	2.45	24.5	9.9	5.0	3.3
4629-3/4-TOC40	30	3.46	26	13.2	6.6	4.4
	40	4.00	27	14.7	7.3	4.9
	60	4.90	27	18.0	9.0	6.0
4629-3/4-TOC80	30	6.93	29	24	11.8	7.9
	40	8.00	30	26	13.2	8.8
	60	9.80	30	32	16.2	10.8
4629-3/4-TOC150	30	13.0	30.5	42	21	14.1
	40	15.0	31.5	47	24	15.7
	60	18.4	31.5	58	29	19.3
4629-3/4-TOC300	30	26.0	32	80	40	27
	40	30.0	33	90	45	30
	60	36.7	33.5	108	54	36

**Note:** Always double check your application rates. Tabulations are based on spraying water at 70°F. See technical information (pages 179–202) for useful formulas and other technical information.



### Typical Applications



**HERBICIDE**  
SOIL APPLIED  
**EXCELLENT**  
SYSTEMIC  
**EXCELLENT**



**FERTILIZER**  
BROADCAST  
**EXCELLENT**



**DRIFT CONTROL**  
**EXCELLENT**



**Type 1/4-KLC**  
1/4" NPT male pipe connections

### FEATURES

- The KLC FieldJet nozzle is typically used to spray areas not accessible with a boom sprayer.
- Its one-piece nozzle design projects spray to both sides to form a wide swath flat spray.

- The round orifice minimizes clogging.
- Uniformity across the swath is not as good as with a properly operated boom sprayer.\*

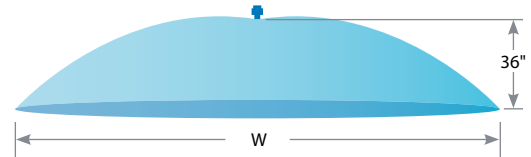

\*Uniformity can be optimized by double overlapping spray swaths on successive sprayer passes. Remember, this also doubles the application volume.

TIP PART NO.	PSI	CAPACITY ONE NOZZLE IN GPM	"W" (FEET)	GALLONS PER ACRE (GPA)				TURF APPLICATION GALLONS PER 1000 SQ. FT.			
				3 MPH	4 MPH	5 MPH	8 MPH	3 MPH	4 MPH	5 MPH	8 MPH
1/4-KLC-5	20	0.71	17	6.9	5.2	4.1	2.6	.16	.12	.09	.06
	30	0.87	18	8.0	6.0	4.8	3.0	.18	.14	.11	.07
	40	1.00	21	7.9	5.9	4.7	2.9	.18	.13	.11	.07
1/4-KLC-9	20	1.27	18	11.6	8.7	7.0	4.4	.27	.20	.16	.10
	30	1.56	19	13.5	10.2	8.1	5.1	.31	.23	.19	.12
	40	1.80	21	14.1	10.6	8.5	5.3	.32	.24	.19	.12
1/4-KLC-18	20	2.55	20	21	15.8	12.6	7.9	.48	.36	.29	.18
	30	3.12	21	25	18.4	14.7	9.2	.56	.42	.34	.21
	40	3.60	22	27	20	16.2	10.1	.62	.46	.37	.23
1/4-KLC-36	20	5.09	22	38	29	23	14.3	.87	.66	.52	.33
	30	6.24	24	43	32	26	16.1	.98	.74	.59	.37
	40	7.20	26	46	34	27	17.1	1.0	.78	.63	.39

**Note:** Always double check your application rates. Tabulations are based on spraying water at 70°F. See technical information (pages 179–202) for useful formulas and other technical information.

### SPRAY PATTERN

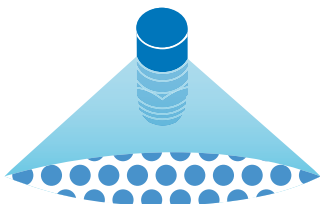

### MATERIALS AVAILABLE

- SS** STAINLESS STEEL
- B** BRASS

### HOW TO ORDER

Stainless Steel  
**1 / 4 K L C - S S 1 8**  
 Tip Type      Material Code      Capacity Size

### Typical Applications



**HERBICIDE**  
SOIL APPLIED  
**EXCELLENT**  
SYSTEMIC  
**EXCELLENT**



**FUNGICIDE**  
SYSTEMIC  
**GOOD**



**INSECTICIDE**  
SYSTEMIC  
**GOOD**



**FERTILIZER**  
BROADCAST  
**EXCELLENT**



**DRIFT CONTROL**  
**EXCELLENT**



### FEATURES

- Wide, even spray pattern allows fewer passes through the field and the ability to cover more area with each pass.
- XE TeeJet Tip can be used in a wide variety of applications—fruits & vegetables, greenhouses, home gardens, urban pest control, sugar cane and flowers.
- Designed for use in hand-held and boomless sprayer applications.
- Optimal use at low pressure.
- Optimum spray height of 20" and optimum spray pressure at 30 PSI.
- Removable pre-orifice for cleaning.
- Acetal polymer material for durability.
- Available in four VisiFlo Polymer (VP) capacities.
- Can be used with 114445A-\*-CELR Quick TeeJet cap and gasket, CP8027-NYB nylon threaded cap, and CP1325 brass threaded cap. Reference page 118 for more information.

### SPRAY PATTERN

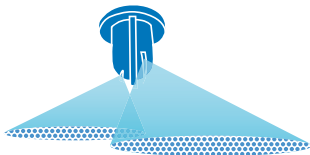

### DROPLET SIZE CLASSIFICATION

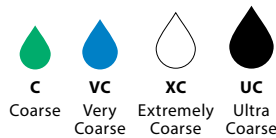

### RECOMMENDED PRESSURE RANGE



### MATERIALS AVAILABLE



### HOW TO ORDER

Polymer with VisiFlo® color-coding

**X E 1 5 0 0 8 - V P**

Tip Type	Spray Angle	Capacity Size	Material Code

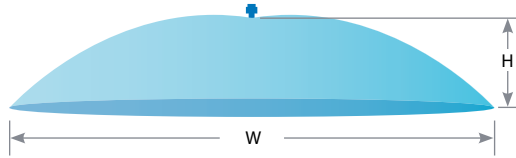

TIP PART NO. (STRAINER MESH SIZE)	PSI	DROP SIZE	CAPACITY ONE TIP IN GPM	SPRAY WIDTH "W" (FEET)		HEIGHT "Y" = 24"								HEIGHT "Y" = 36"											
				24" HEIGHT	36" HEIGHT	GALLONS PER ACRE (GPA)						TURF APP. GALLONS PER 1000 SQ. FT.		GALLONS PER ACRE (GPA)						TURF APP. GALLONS PER 1000 SQ. FT.					
						3 MPH	4 MPH	6 MPH	8 MPH	10 MPH	12 MPH	2 MPH	3 MPH	4 MPH	5 MPH	3 MPH	4 MPH	6 MPH	8 MPH	10 MPH	12 MPH	2 MPH	3 MPH	4 MPH	5 MPH
XE15002-VP (50)	10	UC	0.10	4.9	5.6	3.3	2.5	1.7	1.3	1.0	0.84	0.11	0.08	0.06	0.04	2.9	2.2	1.5	1.1	0.88	0.74	0.10	0.07	0.05	0.04
	15	UC	0.12	6.2	7.2	3.2	2.4	1.6	1.2	1.0	0.81	0.11	0.07	0.06	0.04	2.8	2.1	1.4	1.0	0.84	0.70	0.10	0.06	0.05	0.04
	20	XC	0.14	7.5	8.2	3.1	2.3	1.5	1.2	0.93	0.77	0.11	0.07	0.05	0.04	2.8	2.1	1.4	1.1	0.85	0.71	0.10	0.07	0.05	0.04
	30	XC	0.17	9.2	10.5	3.1	2.3	1.6	1.2	0.93	0.78	0.11	0.07	0.05	0.04	2.7	2.0	1.4	1.0	0.82	0.68	0.09	0.06	0.05	0.04
	40	VC	0.20	10.8	12.5	3.1	2.3	1.5	1.1	0.92	0.76	0.10	0.07	0.05	0.04	2.7	2.0	1.3	1.0	0.80	0.66	0.09	0.06	0.05	0.04
	50	VC	0.22	11.8	13.8	3.1	2.4	1.6	1.2	0.94	0.78	0.11	0.07	0.05	0.04	2.7	2.0	1.3	1.0	0.81	0.67	0.09	0.06	0.05	0.04
	60	VC	0.25	12.5	14.8	3.3	2.4	1.6	1.2	0.98	0.81	0.11	0.07	0.06	0.04	2.7	2.1	1.4	1.0	0.82	0.69	0.09	0.06	0.05	0.04
XE15004-VP (50)	10	UC	0.21	6.2	8.2	5.7	4.3	2.8	2.1	1.7	1.4	0.19	0.13	0.10	0.08	4.3	3.2	2.2	1.6	1.3	1.1	0.15	0.10	0.07	0.06
	15	UC	0.26	8.5	10.8	5.0	3.7	2.5	1.9	1.5	1.2	0.17	0.11	0.09	0.07	3.9	2.9	2.0	1.5	1.2	0.98	0.13	0.09	0.07	0.05
	20	XC	0.29	9.8	11.8	4.9	3.7	2.4	1.8	1.5	1.2	0.17	0.11	0.08	0.07	4.1	3.1	2.0	1.5	1.2	1.0	0.14	0.09	0.07	0.06
	30	XC	0.35	12.1	14.1	4.8	3.6	2.4	1.8	1.4	1.2	0.16	0.11	0.08	0.07	4.1	3.1	2.1	1.5	1.2	1.0	0.14	0.09	0.07	0.06
	40	VC	0.40	13.8	15.7	4.8	3.6	2.4	1.8	1.4	1.2	0.16	0.11	0.08	0.07	4.2	3.1	2.1	1.6	1.3	1.0	0.14	0.10	0.07	0.06
	50	VC	0.44	14.4	16.7	5.1	3.8	2.5	1.9	1.5	1.3	0.17	0.12	0.09	0.07	4.4	3.3	2.2	1.6	1.3	1.1	0.15	0.10	0.07	0.06
	60	VC	0.48	15.4	17.4	5.1	3.9	2.6	1.9	1.5	1.3	0.18	0.12	0.09	0.07	4.6	3.4	2.3	1.7	1.4	1.1	0.16	0.10	0.08	0.06
XE15006-VP (50)	10	UC	0.30	7.9	9.2	6.3	4.7	3.1	2.4	1.9	1.6	0.22	0.14	0.11	0.09	5.4	4.0	2.7	2.0	1.6	1.3	0.18	0.12	0.09	0.07
	15	UC	0.37	9.5	11.8	6.4	4.8	3.2	2.4	1.9	1.6	0.22	0.15	0.11	0.09	5.1	3.8	2.6	1.9	1.5	1.3	0.18	0.12	0.09	0.07
	20	UC	0.42	11.2	13.5	6.3	4.7	3.1	2.4	1.9	1.6	0.22	0.14	0.11	0.09	5.2	3.9	2.6	2.0	1.6	1.3	0.18	0.12	0.09	0.07
	30	XC	0.52	13.1	15.1	6.5	4.9	3.3	2.5	2.0	1.6	0.22	0.15	0.11	0.09	5.7	4.3	2.8	2.1	1.7	1.4	0.20	0.13	0.10	0.08
	40	VC	0.60	14.1	16.1	7.0	5.3	3.5	2.6	2.1	1.8	0.24	0.16	0.12	0.10	6.2	4.6	3.1	2.3	1.8	1.5	0.21	0.14	0.11	0.08
	50	VC	0.67	15.1	17.1	7.3	5.5	3.7	2.7	2.2	1.8	0.25	0.17	0.13	0.10	6.5	4.9	3.2	2.4	1.9	1.6	0.22	0.15	0.11	0.09
	60	C	0.73	16.1	18.0	7.5	5.7	3.8	2.8	2.3	1.9	0.26	0.17	0.13	0.10	6.7	5.0	3.4	2.5	2.0	1.7	0.23	0.15	0.12	0.09
XE15008-VP (50)	10	UC	0.40	8.5	11.5	7.8	5.8	3.9	2.9	2.3	1.9	0.27	0.18	0.13	0.11	5.8	4.3	2.9	2.2	1.7	1.4	0.20	0.13	0.10	0.08
	15	UC	0.49	11.2	12.8	7.3	5.5	3.6	2.7	2.2	1.8	0.25	0.17	0.13	0.10	6.3	4.8	3.2	2.4	1.9	1.6	0.22	0.15	0.11	0.09
	20	UC	0.57	12.1	14.1	7.7	5.8	3.9	2.9	2.3	1.9	0.26	0.18	0.13	0.11	6.6	5.0	3.3	2.5	2.0	1.7	0.23	0.15	0.11	0.09
	30	XC	0.69	13.5	15.4	8.5	6.4	4.3	3.2	2.6	2.1	0.29	0.19	0.15	0.12	7.4	5.6	3.7	2.8	2.2	1.9	0.25	0.17	0.13	0.10
	40	VC	0.80	14.4	16.1	9.1	6.9	4.6	3.4	2.7	2.3	0.31	0.21	0.16	0.13	8.2	6.2	4.1	3.1	2.5	2.1	0.28	0.19	0.14	0.11
	50	C	0.89	15.1	16.7	9.8	7.3	4.9	3.7	2.9	2.4	0.34	0.22	0.17	0.13	8.8	6.6	4.4	3.3	2.6	2.2	0.30	0.20	0.15	0.12
	60	C	0.98	15.7	17.4	10.3	7.7	5.1	3.8	3.1	2.6	0.35	0.23	0.18	0.14	9.3	7.0	4.6	3.5	2.8	2.3	0.32	0.21	0.16	0.13

**Note:** Always double check your application rates. Droplet size classification shown is based on ISO 25358. Droplet size classification standard is subject to change. Tabulations are based on spraying water at 70°F. See technical information (pages 179–202) for droplet size classification, useful formulas and other technical information.

BOOMLESS NOZZLES

## Typical Applications



**HERBICIDE**  
SOIL APPLIED  
**VERY GOOD**  
SYSTEMIC  
**EXCELLENT**



**FUNGICIDE**  
SYSTEMIC  
**GOOD**



**INSECTICIDE**  
SYSTEMIC  
**VERY GOOD**



**DRIFT CONTROL**  
**EXCELLENT**



## FEATURES

- Non-tapered flat spray pattern with a 65° or 95° angle providing even coverage without overlapping.
- Air-induction spray tip producing large air-filled droplets through the use of a Venturi air aspirator.
- Ideal for banding over the row or in row middles.
- Available with stainless steel insert, polymer holder and pre-orifice with VisiFlo® color-coding in eight capacities for the AI95° and six capacities for the AI65°.

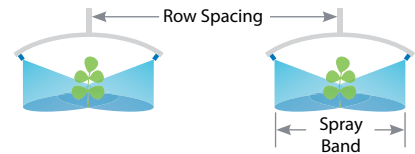

- Automatic spray alignment with 114443A-\* CELR Quick TeeJet cap and gasket. Reference page 118 for more information.

## SPRAY PATTERN

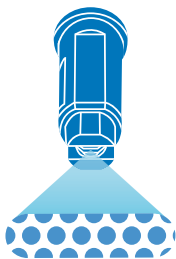

## DROPLET SIZE CLASSIFICATION

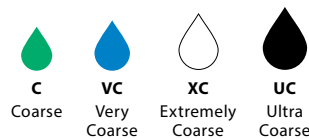

## OPTIMUM SPRAY HEIGHT

HEIGHT	HEIGHT		GPA CONVERSION FACTORS	
	65°	95°	20"	30"
8"	6"	4"	2.50	3.75
10"	8"	5"	2.00	3.00
12"	9"	5"	1.67	2.50
15"	12"	7"	1.33	2.00

To find GPA on the spray band, multiply the tabulated l/ha from the following page for row spacing by the conversion factors above.

- Example:
- Band Width = 8" (Conversion Factor = 3.75)
  - AI9501EVS at 40 PSI at 5 MPH – 5.9 GPA
  - Corrected GPA = 5.9 x 3.75 = 22.1 GPA

## RECOMMENDED PRESSURE RANGE



30-115 PSI

## MATERIALS AVAILABLE

**VS** STAINLESS STEEL

## HOW TO ORDER

Polymer with VisiFlo color-coding

**A I 9 5 0 4 E V S**

Tip Type    Capacity Size    Material Code  
Spray Pattern

TIP PART NO. (STRAINER MESH SIZE)	PSI	DROP SIZE		CAPACITY ONE TIP IN GPM	CAPACITY ONE TIP IN OZ/MIN	APPLICATION RATE FOR 30" SPRAY TIP SPACING											
		65°	95°			3 MPH	3.5 MPH	4 MPH	4.5 MPH	5 MPH	5.5 MPH	6 MPH	6.5 MPH	7 MPH	7.5 MPH	8 MPH	8.5 MPH
AI95015EVS (100)	30	M	C	0.13	17	8.6	7.4	6.4	5.7	5.1	4.7	4.3	4.0	3.7	3.4	3.2	3.0
	40	C	C	0.15	19	9.9	8.5	7.4	6.6	5.9	5.4	5.0	4.6	4.2	4.0	3.7	3.5
	50	C	C	0.17	22	11.2	9.6	8.4	7.5	6.7	6.1	5.6	5.2	4.8	4.5	4.2	4.0
	60	C	C	0.18	23	11.9	10.2	8.9	7.9	7.1	6.5	5.9	5.5	5.1	4.8	4.5	4.2
	70	C	C	0.20	26	13.2	11.3	9.9	8.8	7.9	7.2	6.6	6.1	5.7	5.3	5.0	4.7
	80	C	C	0.21	27	13.9	11.9	10.4	9.2	8.3	7.6	6.9	6.4	5.9	5.5	5.2	4.9
	90	C	C	0.23	29	15.2	13.0	11.4	10.1	9.1	8.3	7.6	7.0	6.5	6.1	5.7	5.4
AI6502EVS AI9502EVS (50)	100	C	C	0.24	31	15.8	13.6	11.9	10.6	9.5	8.6	7.9	7.3	6.8	6.3	5.9	5.6
	30	UC	XC	0.17	22	11.2	9.6	8.4	7.5	6.7	6.1	5.6	5.2	4.8	4.5	4.2	4.0
	40	XC	XC	0.20	26	13.2	11.3	9.9	8.8	7.9	7.2	6.6	6.1	5.7	5.3	5.0	4.7
	50	XC	VC	0.22	28	14.5	12.4	10.9	9.7	8.7	7.9	7.3	6.7	6.2	5.8	5.4	5.1
	60	VC	VC	0.24	31	15.8	13.6	11.9	10.6	9.5	8.6	7.9	7.3	6.8	6.3	5.9	5.6
	70	VC	VC	0.26	33	17.2	14.7	12.9	11.4	10.3	9.4	8.6	7.9	7.4	6.9	6.4	6.1
	80	VC	C	0.28	36	18.5	15.8	13.9	12.3	11.1	10.1	9.2	8.5	7.9	7.4	6.9	6.5
AI65025EVS AI95025EVS (50)	90	VC	C	0.30	38	19.8	17.0	14.9	13.2	11.9	10.8	9.9	9.1	8.5	7.9	7.4	7.0
	100	C	C	0.32	41	21	18.1	15.8	14.1	12.7	11.5	10.6	9.7	9.1	8.4	7.9	7.5
	30	UC	XC	0.22	28	14.5	12.4	10.9	9.7	8.7	7.9	7.3	6.7	6.2	5.8	5.4	5.1
	40	XC	XC	0.25	32	16.5	14.1	12.4	11.0	9.9	9.0	8.3	7.6	7.1	6.6	6.2	5.8
	50	XC	VC	0.28	36	18.5	15.8	13.9	12.3	11.1	10.1	9.2	8.5	7.9	7.4	6.9	6.5
	60	VC	VC	0.31	40	20	17.5	15.3	13.6	12.3	11.2	10.2	9.4	8.8	8.2	7.7	7.2
	70	VC	VC	0.33	42	22	18.7	16.3	14.5	13.1	11.9	10.9	10.1	9.3	8.7	8.2	7.7
AI6503EVS AI9503EVS (50)	80	VC	C	0.35	45	23	19.8	17.3	15.4	13.9	12.6	11.6	10.7	9.9	9.2	8.7	8.2
	90	VC	C	0.38	49	25	21	18.8	16.7	15.0	13.7	12.5	11.6	10.7	10.0	9.4	8.9
	100	VC	C	0.40	51	26	23	19.8	17.6	15.8	14.4	13.2	12.2	11.3	10.6	9.9	9.3
	30	UC	XC	0.26	33	17.2	14.7	12.9	11.4	10.3	9.4	8.6	7.9	7.4	6.9	6.4	6.1
	40	XC	XC	0.30	38	19.8	17.0	14.9	13.2	11.9	10.8	9.9	9.1	8.5	7.9	7.4	7.0
	50	XC	VC	0.34	44	22	19.2	16.8	15.0	13.5	12.2	11.2	10.4	9.6	9.0	8.4	7.9
	60	VC	VC	0.37	47	24	21	18.3	16.3	14.7	13.3	12.2	11.3	10.5	9.8	9.2	8.6
AI6504EVS AI9504EVS (50)	70	VC	VC	0.40	51	26	23	19.8	17.6	15.8	14.4	13.2	12.2	11.3	10.6	9.9	9.3
	80	VC	C	0.42	54	28	24	21	18.5	16.6	15.1	13.9	12.8	11.9	11.1	10.4	9.8
	90	VC	C	0.45	58	30	25	22	19.8	17.8	16.2	14.9	13.7	12.7	11.9	11.1	10.5
	100	VC	C	0.47	60	31	27	23	21	18.6	16.9	15.5	14.3	13.3	12.4	11.6	10.9
	30	UC	XC	0.35	45	23	19.8	17.3	15.4	13.9	12.6	11.6	10.7	9.9	9.2	8.7	8.2
	40	XC	XC	0.40	51	26	23	19.8	17.6	15.8	14.4	13.2	12.2	11.3	10.6	9.9	9.3
	50	XC	VC	0.45	58	30	25	22	19.8	17.8	16.2	14.9	13.7	12.7	11.9	11.1	10.5
AI6505EVS AI9505EVS (50)	60	VC	VC	0.49	63	32	28	24	22	19.4	17.6	16.2	14.9	13.9	12.9	12.1	11.4
	70	VC	VC	0.53	68	35	30	26	23	21	19.1	17.5	16.1	15.0	14.0	13.1	12.3
	80	VC	C	0.57	73	38	32	28	25	23	21	18.8	17.4	16.1	15.0	14.1	13.3
	90	C	C	0.60	77	40	34	30	26	24	22	19.8	18.3	17.0	15.8	14.9	14.0
	100	C	C	0.63	81	42	36	31	28	25	23	21	19.2	17.8	16.6	15.6	14.7
	30	UC	XC	0.43	55	28	24	21	18.9	17.0	15.5	14.2	13.1	12.2	11.4	10.6	10.0
	40	XC	XC	0.50	64	33	28	25	22	19.8	18.0	16.5	15.2	14.1	13.2	12.4	11.6
AI6506EVS AI9506EVS (50)	50	XC	VC	0.56	72	37	32	28	25	22	20	18.5	17.1	15.8	14.8	13.9	13.0
	60	XC	VC	0.61	78	40	35	30	27	24	22	20	18.6	17.3	16.1	15.1	14.2
	70	VC	VC	0.66	84	44	37	33	29	26	24	22	20	18.7	17.4	16.3	15.4
	80	VC	VC	0.71	91	47	40	35	31	28	26	23	22	20	18.7	17.6	16.5
	90	VC	C	0.75	96	50	42	37	33	30	27	25	23	21	19.8	18.6	17.5
	100	VC	C	0.79	101	52	45	39	35	31	28	26	24	22	21	19.6	18.4
	30	UC	UC	0.52	67	34	29	26	23	21	18.7	17.2	15.8	14.7	13.7	12.9	12.1
AI9508EVS (50)	40	XC	XC	0.60	77	40	34	30	26	24	22	19.8	18.3	17.0	15.8	14.9	14.0
	50	XC	XC	0.67	86	44	38	33	29	27	24	22	20	19.0	17.7	16.6	15.6
	60	XC	VC	0.73	93	48	41	36	32	29	26	24	22	21	19.3	18.1	17.0
	70	XC	VC	0.79	101	52	45	39	35	31	28	26	24	22	21	19.6	18.4
	80	VC	VC	0.85	109	56	48	42	37	34	31	28	26	24	22	21	19.8
	90	VC	VC	0.90	115	59	51	45	40	36	32	30	27	25	24	22	21
	100	VC	C	0.95	122	63	54	47	42	38	34	31	29	27	25	24	22
AI9508EVS (50)	30	UC	C	0.69	88	46	39	34	30	27	25	23	21	19.5	18.2	17.1	16.1
	40	XC	C	0.80	102	53	45	40	35	32	29	26	24	23	21	19.8	18.6
	50	XC	C	0.89	114	59	50	44	39	35	32	29	27	25	23	22	21
	60	VC	C	0.98	125	65	55	49	43	39	35	32	30	28	26	24	23
	70	VC	C	1.06	136	70	60	52	47	42	38	35	32	30	28	26	25
	80	VC	C	1.13	145	75	64	56	50	45	41	37	34	32	30	28	26
	90	VC	C	1.20	154	79	68	59	53	48	43	40	37	34	32	30	28
100	C	C	1.26	161	83	71	62	55	50	45	42	38	36	33	31	29	

**Note:** Always double check your application rates. Droplet size classification shown is based on ISO 25358. Droplet size classification standard is subject to change. Tabulations are based on spraying water at 70°F. See technical information (pages 179–202) for droplet size classification, useful formulas and other technical information.



## Typical Applications



**HERBICIDE**  
SOIL APPLIED  
**EXCELLENT**  
SYSTEMIC  
**EXCELLENT**



**FUNGICIDE**  
SYSTEMIC  
**GOOD**



**INSECTICIDE**  
SYSTEMIC  
**GOOD**



**DRIFT CONTROL**  
**VERY GOOD**



## FEATURES

- Non-tapered flat spray pattern with a 95° angle providing even coverage without overlapping.
- Pre-orifice design produces large droplets to reduce drift.
- Ideal for soil applied and systemic herbicide applications.
- Ideal for banding over the row or in row middles.
- Available with stainless steel insert, polymer holder and pre-orifice with VisiFlo color-coding in five capacities.
- Automatic spray alignment with 114441A-\*<sup>TM</sup>-CELR Quick TeeJet® cap and gasket.

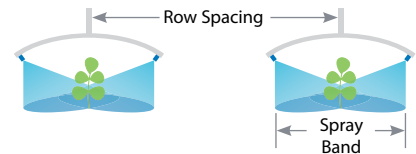

## SPRAY PATTERN

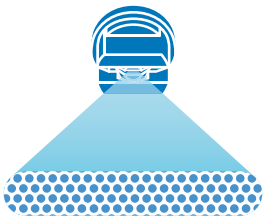

## DROPLET SIZE CLASSIFICATION

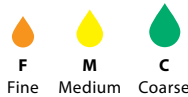

## OPTIMUM SPRAY HEIGHT

95°	HEIGHT	GPA CONVERSION FACTORS	
		20"	30"
8"	4"	2.50	3.75
10"	5"	2.00	3.00
12"	5"	1.67	2.50
15"	7"	1.33	2.00

To find GPA on the spray band, multiply the tabulated GPA from the following page for row spacing by the conversion factors above.

Example:

- Band Width = 8" (Conversion Factor = 3.75)
- DG95015EVS at 40 PSI at 5 MPH – 5.9 GPA
- Corrected GPA = 5.9 x 3.75 = 22.1 GPA

## RECOMMENDED PRESSURE RANGE



30-60 PSI

## MATERIALS AVAILABLE

**VS** STAINLESS STEEL

## HOW TO ORDER

Stainless Steel with VisiFlo® color-coding

D G 9 5 0 1 5 E V S

Tip Type

Capacity Size

Material Code

Spray Pattern

TIP PART NO. (STRAINER MESH SIZE)	PSI	DROP SIZE	CAPACITY ONE TIP IN GPM	CAPACITY ONE TIP IN OZ/MIN	APPLICATION RATE FOR 30" SPRAY TIP SPACING											
					3 MPH	3.5 MPH	4 MPH	4.5 MPH	5 MPH	5.5 MPH	6 MPH	6.5 MPH	7 MPH	7.5 MPH	8 MPH	8.5 MPH
DG95015EVS (100)	30	M	0.13	17	8.6	7.4	6.4	5.7	5.1	4.7	4.3	4.0	3.7	3.4	3.2	3.0
	40	M	0.15	19	9.9	8.5	7.4	6.6	5.9	5.4	5.0	4.6	4.2	4.0	3.7	3.5
	50	F	0.17	22	11.2	9.6	8.4	7.5	6.7	6.1	5.6	5.2	4.8	4.5	4.2	4.0
	60	F	0.18	23	11.9	10.2	8.9	7.9	7.1	6.5	5.9	5.5	5.1	4.8	4.5	4.2
DG9502EVS (50)	30	M	0.17	22	11.2	9.6	8.4	7.5	6.7	6.1	5.6	5.2	4.8	4.5	4.2	4.0
	40	M	0.20	26	13.2	11.3	9.9	8.8	7.9	7.2	6.6	6.1	5.7	5.3	5.0	4.7
	50	M	0.22	28	14.5	12.4	10.9	9.7	8.7	7.9	7.3	6.7	6.2	5.8	5.4	5.1
	60	M	0.24	31	15.8	13.6	11.9	10.6	9.5	8.6	7.9	7.3	6.8	6.3	5.9	5.6
DG9503EVS (50)	30	M	0.26	33	17.2	14.7	12.9	11.4	10.3	9.4	8.6	7.9	7.4	6.9	6.4	6.1
	40	M	0.30	38	19.8	17.0	14.9	13.2	11.9	10.8	9.9	9.1	8.5	7.9	7.4	7.0
	50	M	0.34	44	22	19.2	16.8	15.0	13.5	12.2	11.2	10.4	9.6	9.0	8.4	7.9
	60	M	0.37	47	24	21	18.3	16.3	14.7	13.3	12.2	11.3	10.5	9.8	9.2	8.6
DG9504EVS (50)	30	C	0.35	45	23	19.8	17.3	15.4	13.9	12.6	11.6	10.7	9.9	9.2	8.7	8.2
	40	M	0.40	51	26	23	19.8	17.6	15.8	14.4	13.2	12.2	11.3	10.6	9.9	9.3
	50	M	0.45	58	30	25	22	19.8	17.8	16.2	14.9	13.7	12.7	11.9	11.1	10.5
	60	M	0.49	63	32	28	24	22	19.4	17.6	16.2	14.9	13.9	12.9	12.1	11.4
DG9505EVS (50)	30	C	0.43	55	28	24	21	18.9	17.0	15.5	14.2	13.1	12.2	11.4	10.6	10.0
	40	C	0.50	64	33	28	25	22	19.8	18.0	16.5	15.2	14.1	13.2	12.4	11.6
	50	M	0.56	72	37	32	28	25	22	20	18.5	17.1	15.8	14.8	13.9	13.0
	60	M	0.61	78	40	35	30	27	24	22	20	18.6	17.3	16.1	15.1	14.2

**Note:** Always double check your application rates. Droplet size classification shown is based on ISO 25358. Droplet size classification standard is subject to change. Tabulations are based on spraying water at 70°F. See technical information (pages 179–202) for droplet size classification, useful formulas and other technical information.



## Typical Applications



**HERBICIDE**  
SOIL APPLIED  
**EXCELLENT**  
CONTACT  
**VERY GOOD**  
SYSTEMIC  
**GOOD**



**FUNGICIDE**  
CONTACT  
**EXCELLENT**  
SYSTEMIC  
**GOOD**



**INSECTICIDE**  
CONTACT  
**EXCELLENT**  
SYSTEMIC  
**GOOD**



**DRIFT CONTROL**  
**GOOD**



BANDING NOZZLES

### FEATURES

- Available with VisiFlo® color-coding in stainless steel or all stainless steel, hardened stainless steel and brass even pattern in 30°, 40°, 65°, 80°, 95°, and 110°.
- Non-tapered flat spray pattern providing even coverage without overlapping.
- Ideal for banding over the row or in row middles.
- Automatic spray alignment with 114441A-\* CELR Quick TeeJet cap and gasket.

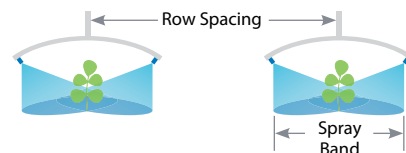

### SPRAY PATTERN

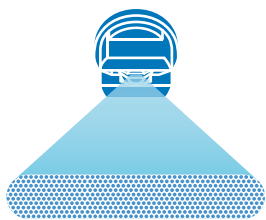

### DROPLET SIZE CLASSIFICATION

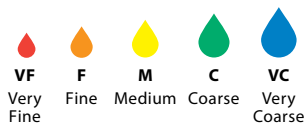

### OPTIMUM SPRAY HEIGHT

HEIGHT	HEIGHT					GPA CONVERSION FACTORS	
	40°	65°	80°	95°	110°	20"	30"
8"	11"	6"	5"	4"	3"	2.50	3.75
10"	14"	8"	6"	5"	4"	2.00	3.00
12"	16"	9"	7"	5"	4"	1.67	2.50
15"	21"	12"	9"	7"	5"	1.33	2.00

To find GPA on the spray band, multiply the tabulated GPA from the following page for row spacing by the conversion factors above.

- Example:
- Band Width = 8" (Conversion Factor = 3.75)
  - TP80015EVS at 40 PSI at 5 MPH – 5.9 GPA
  - Corrected GPA = 5.9 x 3.75 = 22.1 GPA

### RECOMMENDED PRESSURE RANGE



### MATERIALS AVAILABLE

- VS** STAINLESS STEEL
- B** BRASS
- SS** STAINLESS STEEL
- HSS** HARDENED STAINLESS STEEL

TIP PART NO. (STRAINER MESH SIZE)	PSI	DROP SIZE 80°	CAPACITY ONE TIP IN GPM	APPLICATION RATE FOR 30" SPRAY TIP SPACING											
				3 MPH	3.5 MPH	4 MPH	4.5 MPH	5 MPH	5.5 MPH	6 MPH	6.5 MPH	7 MPH	7.5 MPH	8 MPH	8.5 MPH
				TP4001E† TP6501E†	30	F	0.087	5.7	4.9	4.3	3.8	3.4	3.1	2.9	2.7
	40	F	0.10	6.6	5.7	5.0	4.4	4.0	3.6	3.3	3.0	2.8	2.6	2.5	2.3
TP8001E TP9501E (100)	50	F	0.11	7.3	6.2	5.4	4.8	4.4	4.0	3.6	3.4	3.1	2.9	2.7	2.6
	60	VF	0.12	7.9	6.8	5.9	5.3	4.8	4.3	4.0	3.7	3.4	3.2	3.0	2.8
TP40015E† TP65015E†	30	F	0.13	8.6	7.4	6.4	5.7	5.1	4.7	4.3	4.0	3.7	3.4	3.2	3.0
	40	F	0.15	9.9	8.5	7.4	6.6	5.9	5.4	5.0	4.6	4.2	4.0	3.7	3.5
TP80015E TP95015E (100)	50	F	0.17	11.2	9.6	8.4	7.5	6.7	6.1	5.6	5.2	4.8	4.5	4.2	4.0
	60	F	0.18	11.9	10.2	8.9	7.9	7.1	6.5	5.9	5.5	5.1	4.8	4.5	4.2
TP4002E† TP6502E†	30	F	0.17	11.2	9.6	8.4	7.5	6.7	6.1	5.6	5.2	4.8	4.5	4.2	4.0
	40	F	0.20	13.2	11.3	9.9	8.8	7.9	7.2	6.6	6.1	5.7	5.3	5.0	4.7
TP8002E TP9502E (50)	50	F	0.22	14.5	12.4	10.9	9.7	8.7	7.9	7.3	6.7	6.2	5.8	5.4	5.1
	60	F	0.24	15.8	13.6	11.9	10.6	9.5	8.6	7.9	7.3	6.8	6.3	5.9	5.6
TP4003E† TP6503E†	30	M	0.26	17.2	14.7	12.9	11.4	10.3	9.4	8.6	7.9	7.4	6.9	6.4	6.1
	40	F	0.30	19.8	17.0	14.9	13.2	11.9	10.8	9.9	9.1	8.5	7.9	7.4	7.0
TP8003E TP9503E (50)	50	F	0.34	22	19.2	16.8	15.0	13.5	12.2	11.2	10.4	9.6	9.0	8.4	7.9
	60	F	0.37	24	21	18.3	16.3	14.7	13.3	12.2	11.3	10.5	9.8	9.2	8.6
TP4004E† TP6504E†	30	M	0.35	23	19.8	17.3	15.4	13.9	12.6	11.6	10.7	9.9	9.2	8.7	8.2
	40	M	0.40	26	23	19.8	17.6	15.8	14.4	13.2	12.2	11.3	10.6	9.9	9.3
TP8004E TP9504E (50)	50	M	0.45	30	25	22	19.8	17.8	16.2	14.9	13.7	12.7	11.9	11.1	10.5
	60	F	0.49	32	28	24	22	19.4	17.6	16.2	14.9	13.9	12.9	12.1	11.4
TP4005E† TP6505E†	30	M	0.43	28	24	21	18.9	17.0	15.5	14.2	13.1	12.2	11.4	10.6	10.0
	40	M	0.50	33	28	25	22	19.8	18.0	16.5	15.2	14.1	13.2	12.4	11.6
TP8005E TP9505E (50)	50	M	0.56	37	32	28	25	22	20	18.5	17.1	15.8	14.8	13.9	13.0
	60	M	0.61	40	35	30	27	24	22	20	18.6	17.3	16.1	15.1	14.2
TP4006E† TP6506E†	30	C	0.52	34	29	26	23	21	18.7	17.2	15.8	14.7	13.7	12.9	12.1
	40	M	0.60	40	34	30	26	24	22	19.8	18.3	17.0	15.8	14.9	14.0
TP8006E TP9506E (50)	50	M	0.67	44	38	33	29	27	24	22	20	19.0	17.7	16.6	15.6
	60	M	0.73	48	41	36	32	29	26	24	22	21	19.3	18.1	17.0
TP6508E† TP11008E†	30	C	0.69	46	39	34	30	27	25	23	21	19.5	18.2	17.1	16.1
	40	C	0.80	53	45	40	35	32	29	26	24	23	21	19.8	18.6
TP8008E TP9508E (50)	50	M	0.89	59	50	44	39	35	32	29	27	25	23	22	21
	60	M	0.98	65	55	49	43	39	35	32	30	28	26	24	23
TP4010E† TP6510E† TP8010E† TP11010E† (24)	30	VC	0.87	57	49	43	38	34	31	29	27	25	23	22	20
	40	C	1.00	66	57	50	44	40	36	33	30	28	26	25	23
	50	C	1.12	74	63	55	49	44	40	37	34	32	30	28	26
	60	C	1.22	81	69	60	54	48	44	40	37	35	32	30	28
TP6515E† TP8015E† TP11015E†	30	VC	1.30	86	74	64	57	51	47	43	40	37	34	32	30
	40	VC	1.50	99	85	74	66	59	54	50	46	42	40	37	35
	50	C	1.68	111	95	83	74	67	60	55	51	48	44	42	39
	60	C	1.84	121	104	91	81	73	66	61	56	52	49	46	43

**Note:** Always double check your application rates. Droplet size classification shown is based on ISO 25358. Droplet size classification standard is subject to change. Tabulations are based on spraying water at 70°F. See technical information (pages 179–202) for droplet size classification, useful formulas and other technical information.

†Available in brass and/or stainless steel and/or hardened stainless steel.

## HOW TO ORDER

Stainless Steel with VisiFlo color-coding

T P 8 0 0 2 E V S  
 Tip Type    Capacity Size    Material Code  
 Spray Pattern

Brass

T P 8 0 0 2 E  
 Tip Type    Capacity Size  
 Spray Pattern

Stainless Steel

T P 8 0 0 2 E - S S  
 Tip Type    Capacity Size    Material Code  
 Spray Pattern

Hardened Stainless Steel

T P 8 0 0 2 E - H S S  
 Tip Type    Capacity Size    Material Code  
 Spray Pattern

## Typical Applications



**HERBICIDE**  
CONTACT  
VERY GOOD



**FUNGICIDE**  
CONTACT  
VERY GOOD



**INSECTICIDE**  
CONTACT  
VERY GOOD



## FEATURES

- Non-tapered TwinJet flat spray pattern providing even coverage without overlapping.
- The twin flat sprays provide improved coverage and penetration of crop or weeds.
- Fine to medium droplet size is ideal when smaller droplets are necessary for contact products, as herbicides, insecticides, and fungicides.
- Ideal for banding over the row or in row middles.
- Available in stainless steel with VisiFlo® color-coding in 40° and 80° spray angles in four capacities.
- Automatic spray alignment with 114443A-\* CELR Quick TeeJet® cap and gasket. See page 118 for more information.

## SPRAY PATTERN

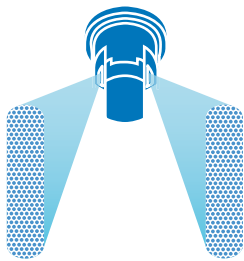

## DROPLET SIZE CLASSIFICATION

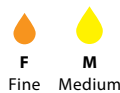

## OPTIMUM SPRAY HEIGHT

	HEIGHT		GPA CONVERSION FACTORS	
	40°	80°	20"	30"
8"	11"	5"	2.50	3.75
10"	14"	6"	2.00	3.00
12"	16"	7"	1.67	2.50
15"	21"	9"	1.33	2.00

To find GPA on the spray band, multiply the tabulated GPA from the following page for row spacing by the conversion factors above.

Example:

- Band Width = 8" (Conversion Factor = 3.75)
- TJ60-4002EVS at 40 PSI at 5 MPH - 7.9 GPA
- Corrected GPA = 7.9 x 3.75 = 29.6 GPA

## RECOMMENDED PRESSURE RANGE



30-60 PSI

## MATERIALS AVAILABLE

**VS** STAINLESS STEEL

## HOW TO ORDER

Stainless Steel with VisiFlo color-coding

**T J 6 0 - 4 0 0 2 E V S**

Tip Type    Spray Angle    Capacity Size    Material Code    Spray Pattern

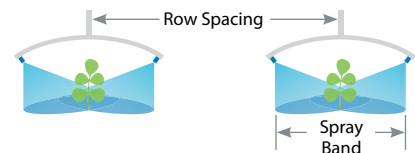



# TwinJet® EVEN FLAT SPRAY

TIP PART NO. (STRAINER MESH SIZE)	PSI	DROP SIZE 80°	CAPACITY ONE TIP IN GPM	CAPACITY ONE TIP IN OZ/MIN	APPLICATION RATE FOR 30" SPRAY TIP SPACING											
					3 MPH	3.5 MPH	4 MPH	4.5 MPH	5 MPH	5.5 MPH	6 MPH	6.5 MPH	7 MPH	7.5 MPH	8 MPH	8.5 MPH
TJ60-4002EVS TJ60-8002EVS (100)	30	F	0.17	22	11.2	9.6	8.4	7.5	6.7	6.1	5.6	5.2	4.8	4.5	4.2	4.0
	40	F	0.20	26	13.2	11.3	9.9	8.8	7.9	7.5	6.6	6.1	5.7	5.3	5.0	4.7
	50	F	0.22	28	14.5	12.4	10.9	9.7	8.7	7.9	7.3	6.7	6.2	5.8	5.4	5.1
	60	F	0.24	31	15.8	13.6	11.9	10.6	9.5	8.6	7.9	7.3	6.8	6.3	5.9	5.6
TJ60-4003EVS TJ60-8003EVS (100)	30	F	0.26	33	17.2	14.7	12.9	11.4	10.3	9.4	8.6	7.9	7.4	6.9	6.4	6.1
	40	F	0.30	38	19.8	17.0	14.9	13.2	11.9	10.8	9.9	9.1	8.5	7.9	7.4	7.0
	50	F	0.34	44	22	19.2	16.8	15.0	13.5	12.2	11.2	10.4	9.6	9.0	8.4	7.9
	60	F	0.37	47	24	21	18.3	16.3	14.7	13.3	12.2	11.3	10.5	9.8	9.2	8.6
TJ60-4004EVS TJ60-8004EVS (50)	30	F	0.35	45	23	19.8	17.3	15.4	13.9	12.6	11.6	10.7	9.9	9.2	8.7	8.2
	40	F	0.40	51	26	23	19.8	17.6	15.8	14.4	13.2	12.2	11.3	10.6	9.9	9.3
	50	F	0.45	58	30	25	22	19.8	17.8	16.2	14.9	13.7	12.7	11.9	11.1	10.5
	60	F	0.49	63	32	28	24	22	19.4	17.6	16.2	14.9	13.9	12.9	12.1	11.4
TJ60-8006EVS (50)	30	M	0.53	67	34	29	26	23	21	18.7	17.2	15.8	14.7	13.7	12.9	12.1
	40	M	0.60	77	40	34	30	26	24	22	19.8	18.3	17.0	15.8	14.9	14.0
	50	F	0.67	86	44	38	33	29	27	24	22	20	19.0	17.7	16.6	15.6
	60	F	0.73	93	48	41	36	32	29	26	24	22	21	19.3	18.1	17.0

**Note:** Always double check your application rates. Droplet size classification shown is based on ISO 25358. Droplet size classification standard is subject to change. Tabulations are based on spraying water at 70°F. See technical information (pages 179–202) for droplet size classification, useful formulas and other technical information.



### Typical Applications



**HERBICIDE**  
CONTACT  
**GOOD**  
SYSTEMIC  
**EXCELLENT**



**INSECTICIDE**  
SYSTEMIC  
**GOOD**



**FERTILIZER**  
BANDING  
**EXCELLENT**



**DRIFT CONTROL**  
**EXCELLENT**



BANDING NOZZLES

### FEATURES

- Air-Induction Spray tip producing large air-filled droplets through the use of a Venturi air aspirator.
- Off-center spray pattern with flat spray characteristics.
- 85° spray angle.
- Underleaf banding of pesticides or liquid fertilizers.
- Used at the end of the spray boom around the perimeter of the field to protect sensitive areas.
- Available with stainless steel insert, polymer holder and pre-orifice with VisiFlo® color-coding in four capacities.
- Automatic spray alignment with 114443A\*-CELR Quick TeeJet cap and gasket. See page 118 for more information.

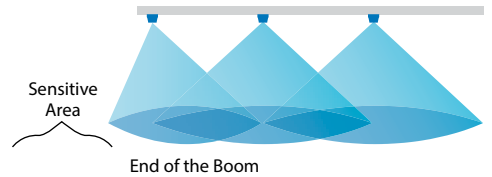
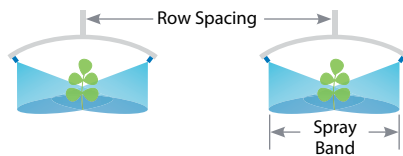
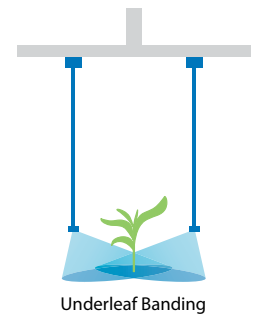

### SPRAY PATTERN

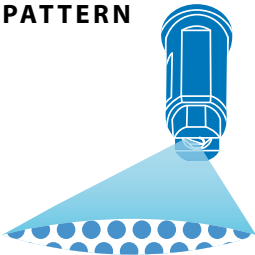

### DROPLET SIZE CLASSIFICATION

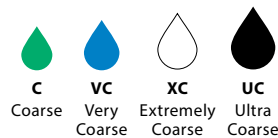

### RECOMMENDED PRESSURE RANGE



### MATERIALS AVAILABLE



### HOW TO ORDER

Stainless Steel with VisiFlo color-coding

**A I U B 8 5 0 2 5 V S**

A	I	U	B	8	5	0	2	5	V	S
Tip Type	Spray Angle	Capacity Size	Material Code							

TIP PART NO. (STRAINER MESH SIZE)	PSI	DROP SIZE	CAPACITY ONE TIP IN GPM	CAPACITY ONE TIP IN OZ/MIN	APPLICATION RATE FOR 20" SPRAY TIP SPACING						APPLICATION RATE FOR 30" SPRAY TIP SPACING					
					3 MPH	4 MPH	5 MPH	6 MPH	7 MPH	8 MPH	3 MPH	4 MPH	5 MPH	6 MPH	7 MPH	8 MPH
AIUB8502 (50)	30	UC	0.17	22	16.8	12.6	10.1	8.4	7.2	6.3	11.2	8.4	6.7	5.6	4.8	4.2
	40	XC	0.20	26	19.8	14.9	11.9	9.9	8.5	7.4	13.2	9.9	7.9	6.6	5.7	5.0
	50	XC	0.22	28	22	16.3	13.1	10.9	9.3	8.2	14.5	10.9	8.7	7.3	6.2	5.4
	60	VC	0.24	31	24	17.8	14.3	11.9	10.2	8.9	15.8	11.9	9.5	7.9	6.8	5.9
	70	VC	0.26	33	26	19.3	15.4	12.9	11.0	9.7	17.2	12.9	10.3	8.6	7.4	6.4
	80	VC	0.28	36	28	21	16.6	13.9	11.9	10.4	18.5	13.9	11.1	9.2	7.9	6.9
	90	C	0.30	38	30	22	17.8	14.9	12.7	11.1	19.8	14.9	11.9	9.9	8.5	7.4
	100	C	0.32	41	32	24	19.0	15.8	13.6	11.9	21	15.8	12.7	10.6	9.1	7.9
AIUB85025 (50)	30	XC	0.22	28	22	16.3	13.1	10.9	9.3	8.2	14.5	10.9	8.7	7.3	6.2	5.4
	40	XC	0.25	32	25	18.6	14.9	12.4	10.6	9.3	16.5	12.4	9.9	8.3	7.1	6.2
	50	VC	0.28	36	28	21	16.6	13.9	11.9	10.4	18.5	13.9	11.1	9.2	7.9	6.9
	60	VC	0.31	40	31	23	18.4	15.3	13.2	11.5	20	15.3	12.3	10.2	8.8	7.7
	70	VC	0.33	42	33	25	19.6	16.3	14.0	12.3	22	16.3	13.1	10.9	9.3	8.2
	80	C	0.35	45	35	26	21	17.3	14.9	13.0	23	17.3	13.9	11.6	9.9	8.7
	90	C	0.38	49	38	28	23	18.8	16.1	14.1	25	18.8	15.0	12.5	10.7	9.4
	100	C	0.40	51	40	30	24	19.8	17.0	14.9	26	19.8	15.8	13.2	11.3	9.9
AIUB8503 (50)	30	XC	0.26	33	26	19.3	15.4	12.9	11.0	9.7	17.2	12.9	10.3	8.6	7.4	6.4
	40	XC	0.30	38	30	22	17.8	14.9	12.7	11.1	19.8	14.9	11.9	9.9	8.5	7.4
	50	VC	0.34	44	34	25	20	16.8	14.4	12.6	22	16.8	13.5	11.2	9.6	8.4
	60	VC	0.37	47	37	27	22	18.3	15.7	13.7	24	18.3	14.7	12.2	10.5	9.2
	70	VC	0.40	51	40	30	24	19.8	17.0	14.9	26	19.8	15.8	13.2	11.3	9.9
	80	C	0.42	54	42	31	25	21	17.8	15.6	28	21	16.6	13.9	11.9	10.4
	90	C	0.45	58	45	33	27	22	19.1	16.7	30	22	17.8	14.9	12.7	11.1
	100	C	0.47	60	47	35	28	23	19.9	17.4	31	23	18.6	15.5	13.3	11.6
AIUB8504 (50)	30	XC	0.35	45	35	26	21	17.3	14.9	13.0	23	17.3	13.9	11.6	9.9	8.7
	40	XC	0.40	51	40	30	24	19.8	17.0	14.9	26	19.8	15.8	13.2	11.3	9.9
	50	VC	0.45	58	45	33	27	22	19.1	16.7	30	22	17.8	14.9	12.7	11.1
	60	VC	0.49	63	49	36	29	24	21	18.2	32	24	19.4	16.2	13.9	12.1
	70	VC	0.53	68	52	39	31	26	22	19.7	35	26	21	17.5	15.0	13.1
	80	C	0.57	73	56	42	34	28	24	21	38	28	23	18.8	16.1	14.1
	90	C	0.60	77	59	45	36	30	25	22	40	30	24	19.8	17.0	14.9
	100	C	0.63	81	62	47	37	31	27	23	42	31	25	21	17.8	15.6

BANDING NOZZLES

**Note:** Always double check your application rates. Droplet size classification shown is based on ISO 25358. Droplet size classification standard is subject to change. Tabulations are based on spraying water at 70°F. See technical information (pages 179–202) for droplet size classification, useful formulas and other technical information.

## FEATURES

- Off-center tip with tapered flat spray characteristics.
- 85° spray angle.
- Available in brass or stainless steel.
- Operating pressure 20–60 PSI.
- Uniform distribution.
- Capacities of 0075 to 04.

## MATERIALS AVAILABLE

- SS** STAINLESS STEEL
- B** BRASS

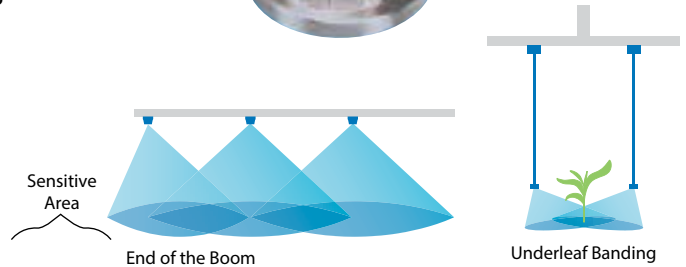

TIP PART NO. (STRAINER MESH SIZE)	PSI	CAPACITY TWO TIPS IN GPM	CAPACITY TWO TIPS IN OZ/MIN	APPLICATION RATE FOR 30" SPRAY TIP SPACING (TWO SPRAY TIPS PER ROW)										
				2 MPH	2.5 MPH	3 MPH	3.5 MPH	4MPH	4.5MPH	5 MPH	5.5 MPH	6 MPH	6.5 MPH	7 MPH
<b>D25143-UB-850075</b> (100)	20	0.11	14	10.9	8.7	7.3	6.2	5.4	4.8	4.4	4.0	3.6	3.4	3.1
	30	0.13	17	12.9	10.3	8.6	7.4	6.4	5.7	5.1	4.7	4.3	4.0	3.7
	40	0.15	19	14.9	11.9	9.9	8.5	7.4	6.6	5.9	5.4	5.0	4.6	4.2
	50	0.17	22	16.8	13.5	11.2	9.6	8.4	7.5	6.7	6.1	5.6	5.2	4.8
	60	0.18	23	17.8	14.3	11.9	10.2	8.9	7.9	7.1	6.5	5.9	5.5	5.1
<b>D25143-UB-8501</b> (100)	20	0.14	18	13.9	11.1	9.2	7.9	6.9	6.2	5.5	5.0	4.6	4.3	4.0
	30	0.17	22	16.8	13.5	11.2	9.6	8.4	7.5	6.7	6.1	5.6	5.2	4.8
	40	0.20	26	19.8	15.8	13.2	11.3	9.9	8.8	7.9	7.2	6.6	6.1	5.7
	50	0.22	28	22	17.4	14.5	12.4	10.9	9.7	8.7	7.9	7.3	6.7	6.2
	60	0.24	31	24	19.0	15.8	13.6	11.9	10.6	9.5	8.6	7.9	7.3	6.8
<b>D25143-UB-85015</b> (80)	20	0.21	27	21	16.6	13.9	11.9	10.4	9.2	8.3	7.6	6.9	6.4	5.9
	30	0.26	33	26	21	17.2	14.7	12.9	11.4	10.3	9.4	8.6	7.9	7.4
	40	0.30	38	30	24	19.8	17.0	14.9	13.2	11.9	10.8	9.9	9.1	8.5
	50	0.34	44	34	27	22	19.2	16.8	15.0	13.5	12.2	11.2	10.4	9.6
	60	0.37	47	37	29	24	21	18.3	16.3	14.7	13.3	12.2	11.3	10.5
<b>D25143-UB-8502</b> (50)	20	0.28	36	28	22	18.5	15.8	13.9	12.3	11.1	10.1	9.2	8.5	7.9
	30	0.35	45	35	28	23	19.8	17.3	15.4	13.9	12.6	11.6	10.7	9.9
	40	0.40	51	40	32	26	23	19.8	17.6	15.8	14.4	13.2	12.2	11.3
	50	0.45	58	45	36	30	25	22	19.8	17.8	16.2	14.9	13.7	12.7
	60	0.49	63	49	39	32	28	24	22	19.4	17.6	16.2	14.9	13.9
<b>D25143-UB-8503</b> (50)	20	0.42	54	42	33	28	24	21	18.5	16.6	15.1	13.9	12.8	11.9
	30	0.52	67	51	41	34	29	26	23	21	18.7	17.2	15.8	14.7
	40	0.60	77	59	48	40	34	30	26	24	22	19.8	18.3	17.0
	50	0.67	86	66	53	44	38	33	29	27	24	22	20	19.0
	60	0.73	93	72	58	48	41	36	32	29	26	24	22	21
<b>D25143-UB-8504</b> (50)	20	0.57	73	56	45	38	32	28	25	23	21	18.8	17.4	16.1
	30	0.69	88	68	55	46	39	34	30	27	25	23	21	19.5
	40	0.80	102	79	63	53	45	40	35	32	29	26	24	23
	50	0.89	114	88	70	59	50	44	39	35	32	29	27	25
	60	0.98	125	97	78	65	55	49	43	39	35	32	30	28

**Note:** Always double check your application rates. Tabulations are based on spraying water at 70°F. See technical information (pages 179–202) for useful formulas and other technical information.

## FEATURES

- Provides coarse spray with full cone pattern.
- Used frequently for tobacco plant sucker control.

## SPRAY PATTERN

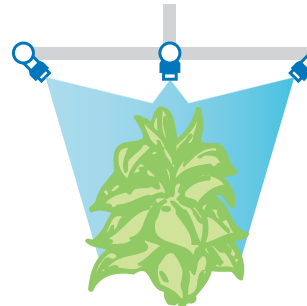
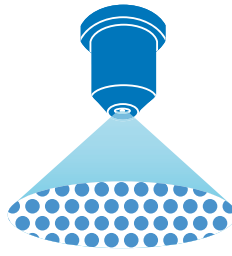

Three Spray Tips  
Per Row Spacing



TIP PART NO.	PSI	CAPACITY ONE TIP IN GPM	CAPACITY ONE TIP IN OZ/MIN	APPLICATION RATE FOR 48" SPRAY TIP SPACING (THREE SPRAY TIPS PER ROW)							
				2 MPH	2.5 MPH	3 MPH	3.5 MPH	4MPH	4.5MPH	5 MPH	5.5 MPH
TG-1	20	0.14	18	26	21	17.3	14.9	13.0	11.6	10.4	9.5
	30	0.16	20	30	24	19.8	17.0	14.9	13.2	11.9	10.8
	40	0.19	24	35	28	24	20	17.6	15.7	14.1	12.8
	60	0.23	29	43	34	28	24	21	19.0	17.1	15.5
TG-2	20	0.28	36	52	42	35	30	26	23	21	18.9
	30	0.33	42	61	49	41	35	31	27	25	22
	40	0.38	49	71	56	47	40	35	31	28	26
	60	0.46	59	85	68	57	49	43	38	34	31
TG-3	20	0.41	52	76	61	51	43	38	34	30	28
	30	0.50	64	93	74	62	53	46	41	37	34
	40	0.57	73	106	85	71	60	53	47	42	38
	60	0.68	87	126	101	84	72	63	56	50	46
TG-4	20	0.55	70	102	82	68	58	51	45	41	37
	30	0.66	84	123	98	82	70	61	54	49	45
	40	0.76	97	141	113	94	81	71	63	56	51
	60	0.91	116	169	135	113	97	84	75	68	61
TG-5	20	0.69	88	128	102	85	73	64	57	51	47
	30	0.84	108	156	125	104	89	78	69	62	57
	40	1.00	128	186	149	124	106	93	83	74	68
	60	1.16	148	215	172	144	123	108	96	86	78
TG-6	20	0.82	105	152	122	101	87	76	68	61	55
	30	0.99	127	184	147	123	105	92	82	74	67
	40	1.14	146	212	169	141	121	106	94	85	77
	60	1.37	175	254	203	170	145	127	113	102	92
TG-8	20	1.10	141	204	163	136	117	102	91	82	74
	30	1.33	170	247	198	165	141	123	110	99	90
	40	1.51	193	280	224	187	160	140	125	112	102
	60	1.82	233	338	270	225	193	169	150	135	123

**Note:** Always double check your application rates. Tabulations are based on spraying water at 70°F. See technical information (pages 179–202) for useful formulas and other technical information.



## Typical Applications



**FUNGICIDE**  
CONTACT  
**EXCELLENT**  
SYSTEMIC  
**GOOD**



**INSECTICIDE**  
CONTACT  
**EXCELLENT**  
SYSTEMIC  
**GOOD**

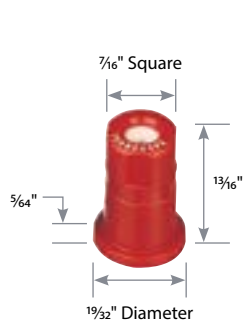

**TXA ConeJet**

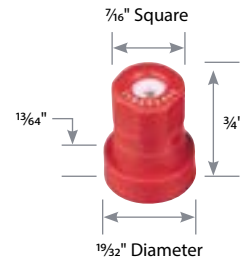

**TXB ConeJet**



BANDING NOZZLES

### FEATURES

- Finely atomized spray pattern provides thorough coverage.
- Ideal for banding with two or three nozzles over the row.
- VisiFlo color-coded polypropylene body and ceramic orifice insert for long wear life.
- Resists corrosion.
- Accepts more abrasive materials.
- Available in seven VisiFlo® ceramic (VK) capacities.
- Can be used with 114445A-\*CELR caps and gasket. See page 118 for more information.

### RECOMMENDED PRESSURE RANGE



30–300 PSI

### MATERIALS AVAILABLE



CERAMIC

### SPRAY PATTERN



### DROPLET SIZE CLASSIFICATION



### OPTIMUM SPRAY HEIGHT

	GPA CONVERSION FACTORS	
	20"	30"
8"	2.50	3.75
10"	2.00	3.00
12"	1.67	2.50
15"	1.33	2.00

To find GPA on the spray band, multiply the tabulated GPA from the following page for row spacing by the conversion factors above.

Example:

- Band Width = 8" (Conversion Factor = 3.75)
- Two tips TXA80015 at 40 PSI at 5MPH – 11.9 GPA
- Corrected GPA = 11.9 x 3.75 = 44.6 GPA

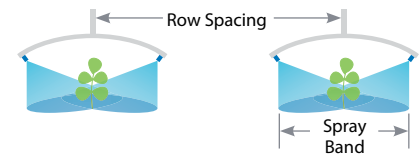

### HOW TO ORDER

Ceramic with VisiFlo color-coding

**T X A 8 0 0 4 V K**

Tip Type    Spray Angle    Capacity Size    Material Code

Ceramic with VisiFlo color-coding

**T X B 8 0 0 1 5 V K**

Tip Type    Spray Angle    Capacity Size    Material Code

# ConeJet® CERAMIC VISIFLO® SPRAY

TIP PART NO. (STRAINER MESH SIZE)	PSI	DROP SIZE	CAPACITY TWO SPRAY TIPS IN GPM	CAPACITY TWO SPRAY TIPS IN OZ/MIN	APPLICATION RATE FOR 30" SPRAY TIP SPACING					CAPACITY THREE SPRAY TIPS IN GPM	CAPACITY THREE SPRAY TIPS IN OZ/MIN	APPLICATION RATE FOR 30" SPRAY TIP SPACING				
					3 MPH	4 MPH	5 MPH	6 MPH	7 MPH			3 MPH	4 MPH	5 MPH	6 MPH	7 MPH
TXA800050VK TXB800050VK (100)	40	VF	0.10	13	6.6	5.0	4.0	3.3	2.8	0.15	19	9.9	7.4	5.9	5.0	4.2
	60	VF	0.12	15	7.9	5.9	4.8	4.0	3.4	0.18	23	11.9	8.9	7.1	5.9	5.1
	80	VF	0.14	18	9.2	6.9	5.5	4.6	4.0	0.20	26	13.2	9.9	7.9	6.6	5.7
	100	VF	0.15	19	9.9	7.4	5.9	5.0	4.2	0.22	28	14.5	10.9	8.7	7.3	6.2
	125	VF	0.16	20	10.6	7.9	6.3	5.3	4.5	0.25	32	16.5	12.4	9.9	8.3	7.1
TXA800067VK TXB800067VK (50)	40	VF	0.13	17	8.6	6.4	5.1	4.3	3.7	0.20	26	13.2	9.9	7.9	6.6	5.7
	60	VF	0.16	20	10.6	7.9	6.3	5.3	4.5	0.24	31	15.8	11.9	9.5	7.9	6.8
	80	VF	0.18	23	11.9	8.9	7.1	5.9	5.1	0.27	35	17.8	13.4	10.7	8.9	7.6
	100	VF	0.20	26	13.4	10.0	8.0	6.7	5.7	0.30	39	20	15.0	12.0	10.0	8.6
	125	VF	0.22	29	14.8	11.1	8.9	7.4	6.3	0.34	43	22	16.6	13.3	11.1	9.5
TXA8001VK TXB8001VK (50)	40	VF	0.20	26	13.2	9.9	7.9	6.6	5.7	0.30	38	19.8	14.9	11.9	9.9	8.5
	60	VF	0.24	31	15.9	11.9	9.5	7.9	6.8	0.36	46	24	17.9	14.3	11.9	10.2
	80	VF	0.27	35	18.1	13.6	10.9	9.1	7.8	0.41	53	27	20	16.3	13.6	11.6
	100	VF	0.30	39	20	15.0	12.0	10.0	8.6	0.46	58	30	23	18.0	15.0	12.9
	125	VF	0.34	43	22	16.6	13.3	11.1	9.5	0.50	65	33	25	20	16.6	14.3
TXA80015VK TXB80015VK (50)	40	VF	0.30	38	19.8	14.9	11.9	9.9	8.5	0.45	58	30	22	17.8	14.9	12.7
	60	VF	0.36	47	24	18.0	14.4	12.0	10.3	0.55	70	36	27	22	18.0	15.5
	80	VF	0.42	53	28	21	16.5	13.8	11.8	0.63	80	41	31	25	21	17.7
	100	VF	0.46	60	31	23	18.4	15.3	13.1	0.70	89	46	35	28	23	19.7
	125	VF	0.52	66	34	26	20	17.1	14.6	0.78	99	51	38	31	26	22
TXA8002VK TXB8002VK (50)	40	F	0.40	51	26	19.8	15.8	13.2	11.3	0.60	77	40	30	24	19.8	17.0
	60	VF	0.49	62	32	24	19.2	16.0	13.7	0.73	93	48	36	29	24	21
	80	VF	0.56	71	37	28	22	18.4	15.8	0.84	107	55	41	33	28	24
	100	VF	0.62	79	41	31	25	20	17.5	0.93	119	61	46	37	31	26
	125	VF	0.69	88	46	34	27	23	19.5	1.03	132	68	51	41	34	29
TXA8003VK TXB8003VK (50)	40	F	0.60	77	40	30	24	19.8	17.0	0.90	115	59	45	36	30	25
	60	VF	0.73	94	48	36	29	24	21	1.10	141	73	54	44	36	31
	80	VF	0.85	108	56	42	34	28	24	1.27	162	84	63	50	42	36
	100	VF	0.94	121	62	47	37	31	27	1.42	181	94	70	56	47	40
	125	VF	1.06	135	70	52	42	35	30	1.58	203	105	78	63	52	45
TXA8004VK TXB8004VK (50)	40	F	0.80	102	53	40	32	26	23	1.20	154	79	59	48	40	34
	60	VF	0.98	125	65	48	39	32	28	1.47	188	97	73	58	48	42
	80	VF	1.13	144	74	56	45	37	32	1.69	217	112	84	67	56	48
	100	VF	1.26	161	83	62	50	42	36	1.89	242	125	94	75	62	53
	125	VF	1.41	180	93	70	56	46	40	2.11	270	139	105	84	70	60

**Note:** Always double check your application rates. Droplet size classification shown is based on ISO 25358. Droplet size classification standard is subject to change. Tabulations are based on spraying water at 70°F. See technical information (pages 179–202) for droplet size classification, useful formulas and other technical information.



BANDING NOZZLES

## Typical Applications



**FUNGICIDE**  
CONTACT  
**EXCELLENT**  
SYSTEMIC  
**GOOD**



**INSECTICIDE**  
CONTACT  
**EXCELLENT**  
SYSTEMIC  
**GOOD**

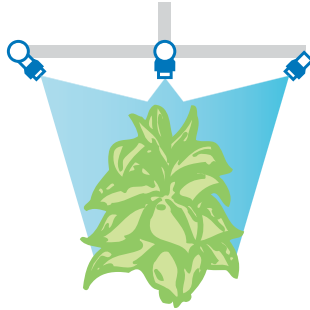

Three Spray Tips Per Row Spacing



BANDING NOZZLES

## FEATURES

- Finely atomized spray pattern provides thorough coverage.
- Ideal for banding with two or three nozzles over the row.
- Color-coded versions consist of stainless steel or ceramic orifice in a polypropylene body. Maximum operating pressure 300 PSI.
- Standard ConeJet (not color-coded) available in brass and stainless steel in a wide range of capacities with 65° (TY) and 80° (TX) spray angles.

## SPRAY PATTERN



## DROPLET SIZE CLASSIFICATION



## OPTIMUM SPRAY HEIGHT

	GPA CONVERSION FACTORS	
	20"	30"
8"	2.50	3.75
10"	2.00	3.00
12"	1.67	2.50
15"	1.33	2.00

To find GPA on the spray band, multiply the tabulated GPA from the following page for row spacing by the conversion factors above.

Example:

- Band Width = 8" (Conversion Factor = 3.75)
- Two tips TX-VK3 at 40 PSI at 5MPH – 4 GPA
- Corrected GPA = 4 x 3.75 = 15 GPA

## RECOMMENDED PRESSURE RANGE



30–300 PSI

## MATERIALS AVAILABLE



STAINLESS STEEL



CERAMIC



BRASS



STAINLESS STEEL

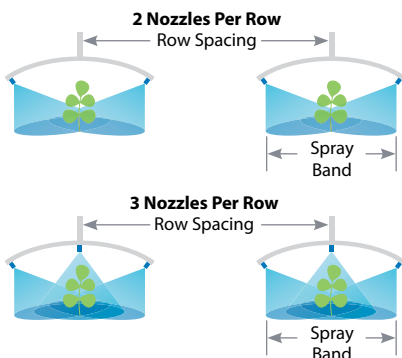

TIP PART NO. (STRAINER MESH SIZE)	PSI	DROP SIZE	CAPACITY TWO TIPS IN GPM	CAPACITY TWO TIPS IN OZ/MIN	APPLICATION RATE FOR 30" SPRAY TIP SPACING					CAPACITY THREE TIPS IN GPM	CAPACITY THREE TIPS IN OZ/MIN	APPLICATION RATE FOR 30" SPRAY TIP SPACING				
					3 MPH	4 MPH	5 MPH	6 MPH	7 MPH			3 MPH	4 MPH	5 MPH	6 MPH	7 MPH
TX-1	40	VF	0.033	4.2	2.2	1.6	1.3	1.1	0.93	0.050	6.4	3.3	2.5	2.0	1.7	1.4
	60	VF	0.039	5.0	2.6	1.9	1.5	1.3	1.1	0.059	7.6	3.9	2.9	2.3	1.9	1.7
TX-11 (100)	75	VF	0.043	5.5	2.8	2.1	1.7	1.4	1.2	0.065	8.3	4.3	3.2	2.6	2.1	1.8
	90	VF	0.047	6.0	3.1	2.3	1.9	1.6	1.3	0.070	9.0	4.6	3.5	2.8	2.3	2.0
TX-2	120	VF	0.053	6.8	3.5	2.6	2.1	1.7	1.5	0.079	10	5.2	3.9	3.1	2.6	2.2
	40	VF	0.067	8.6	4.4	3.3	2.7	2.2	1.9	0.100	13	6.6	5.0	4.0	3.3	2.8
TX-12 (100)	60	VF	0.080	10	5.3	4.0	3.2	2.6	2.3	0.12	15	7.9	5.9	4.8	4.0	3.4
	75	VF	0.088	11	5.8	4.4	3.5	2.9	2.5	0.13	17	8.6	6.4	5.1	4.3	3.7
TX-3	90	VF	0.095	12	6.3	4.7	3.8	3.1	2.7	0.14	18	9.2	6.9	5.5	4.6	4.0
	120	VF	0.11	14	7.3	5.4	4.4	3.6	3.1	0.16	20	10.6	7.9	6.3	5.3	4.5
TX-13 (100)	40	VF	0.10	13	6.6	5.0	4.0	3.3	2.8	0.15	19	9.9	7.4	5.9	5.0	4.2
	60	VF	0.12	15	7.9	5.9	4.8	4.0	3.4	0.18	23	11.9	8.9	7.1	5.9	5.1
TX-4	75	VF	0.13	17	8.6	6.4	5.1	4.3	3.7	0.20	26	13.2	9.9	7.9	6.6	5.7
	90	VF	0.14	18	9.2	6.9	5.5	4.6	4.0	0.21	27	13.9	10.4	8.3	6.9	5.9
TX-14 (50)	120	VF	0.16	20	10.6	7.9	6.3	5.3	4.5	0.24	31	15.8	11.9	9.5	7.9	6.8
	40	VF	0.13	17	8.6	6.4	5.1	4.3	3.7	0.20	26	13.2	9.9	7.9	6.6	5.7
TX-6	60	VF	0.16	20	10.6	7.9	6.3	5.3	4.5	0.24	31	15.8	11.9	9.5	7.9	6.8
	75	VF	0.18	23	11.9	8.9	7.1	5.9	5.1	0.27	35	17.8	13.4	10.7	8.9	7.6
TX-16 (50)	90	VF	0.19	24	12.5	9.4	7.5	6.3	5.4	0.29	37	19.1	14.4	11.5	9.6	8.2
	120	VF	0.22	28	14.5	10.9	8.7	7.3	6.2	0.33	42	22	16.3	13.1	10.9	9.3
TX-8	40	VF	0.20	26	13.2	9.9	7.9	6.6	5.7	0.30	38	19.8	14.9	11.9	9.9	8.5
	60	VF	0.24	31	15.8	11.9	9.5	7.9	6.8	0.36	46	24	17.8	14.3	11.9	10.2
TX-18 (50)	75	VF	0.27	35	17.8	13.4	10.7	8.9	7.6	0.40	51	26	19.8	15.8	13.2	11.3
	90	VF	0.29	37	19.1	14.4	11.5	9.6	8.2	0.43	55	28	21	17.0	14.2	12.2
TX-10	120	VF	0.33	42	22	16.3	13.1	10.9	9.3	0.50	64	33	25	19.8	16.5	14.1
	40	VF	0.27	35	17.8	13.4	10.7	8.9	7.6	0.40	51	26	19.8	15.8	13.2	11.3
TX-10 (50)	60	VF	0.32	41	21	15.8	12.7	10.6	9.1	0.49	63	32	24	19.4	16.2	13.9
	75	VF	0.36	46	24	17.8	14.3	11.9	10.2	0.54	69	36	27	21	17.8	15.3
TX-12 (50)	90	VF	0.39	50	26	19.3	15.4	12.9	11.0	0.59	76	39	29	23	19.5	16.7
	120	VF	0.45	58	30	22	17.8	14.9	12.7	0.68	87	45	34	27	22	19.2
TX-18 (50)	40	F	0.40	51	26	19.8	15.8	13.2	11.3	0.60	77	40	30	24	19.8	17.0
	60	VF	0.40	51	26	19.8	15.8	13.2	11.3	0.61	78	40	30	24	20	17.3
TX-12 (50)	75	VF	0.45	58	30	22	17.8	14.9	12.7	0.68	87	45	34	27	22	19.2
	90	VF	0.49	63	32	24	19.4	16.2	13.9	0.74	95	49	37	29	24	21
TX-18 (50)	120	VF	0.56	72	37	28	22	18.5	15.8	0.85	109	56	42	34	28	24
	40	F	0.40	51	26	19.8	15.8	13.2	11.3	0.60	77	40	30	24	19.8	17.0
TX-18 (50)	60	VF	0.49	63	32	24	19.4	16.2	13.9	0.73	93	48	36	29	24	21
	75	VF	0.54	69	36	27	21	17.8	15.3	0.81	104	53	40	32	27	23
TX-18 (50)	90	VF	0.59	76	39	29	23	19.5	16.7	0.88	113	58	44	35	29	25
	120	VF	0.68	87	45	34	27	22	19.2	1.01	129	67	50	40	33	29
TX-26 (50)	40	F	0.60	77	40	30	24	19.8	17.0	0.90	115	59	45	36	30	25
	60	VF	0.73	93	48	36	29	24	21	1.10	141	73	54	44	36	31
TX-26 (50)	75	VF	0.82	105	54	41	32	27	23	1.23	157	81	61	49	41	35
	90	VF	0.90	115	59	45	36	30	25	1.35	173	89	67	53	45	38
TX-26 (50)	120	VF	1.03	132	68	51	41	34	29	1.55	198	102	77	61	51	44
	40	F	0.87	111	57	43	34	29	25	1.30	166	86	64	51	43	37
TX-26 (50)	60	F	1.06	136	70	52	42	35	30	1.59	204	105	79	63	52	45
	75	VF	1.18	151	78	58	47	39	33	1.78	228	117	88	70	59	50
TX-26 (50)	90	VF	1.30	166	86	64	51	43	37	1.94	248	128	96	77	64	55
	120	VF	1.49	191	98	74	59	49	42	2.24	287	148	111	89	74	63

**Note:** Always double check your application rates. Droplet size classification shown is based on ISO 25358. Droplet size classification standard is subject to change. Tabulations are based on spraying water at 70°F. See technical information (pages 179–202) for droplet size classification, useful formulas and other technical information.

†Specify material.

## HOW TO ORDER

Stainless Steel with color-coding

**T X - V S 4**  
 Tip Type | Material Code | Capacity Size

Brass

**T X - 4**  
 Tip Type | Capacity Size

Stainless Steel

**T X - S S 4**  
 Tip Type | Material Code | Capacity Size

Ceramic with color-coding

**T X - V K 4**  
 Tip Type | Material Code | Capacity Size

## Typical Applications



**FUNGICIDE**  
CONTACT  
**EXCELLENT**  
SYSTEMIC  
**GOOD**



**INSECTICIDE**  
CONTACT  
**EXCELLENT**  
SYSTEMIC  
**GOOD**



**FERTILIZER**  
**EXCELLENT**



AIR BLAST NOZZLES

## FEATURES

- Finely atomized spray pattern provides thorough coverage.
- Use for directed applications in air blast spraying for orchards and vineyards and other specialty crops.
- Color-coded version consists of stainless steel or ceramic orifice in polypropylene body.
- Spray angle is 80° at 100 PSI.
- TX-VS1 and TX-VS2 available in VisiFlo® color-coded stainless steel only.
- Compatible with TeeJet cap CP20230 for use on rollovers and threaded nozzle bodies, tighten to a maximum torque of: 100 in-lbs.
- Uses 114445A\*-CELR Quick TeeJet® cap and gasket. Reference page 118 for more information.

## SPRAY PATTERN



## DROPLET SIZE CLASSIFICATION



## RECOMMENDED PRESSURE RANGE



## MATERIALS AVAILABLE

- VS** STAINLESS STEEL
- VK** CERAMIC
- SS** STAINLESS STEEL
- B** BRASS



TIP PART NO.	STRAINER MESH SIZE	CAPACITY (GPM)																	
		30 PSI	40 PSI	50 PSI	60 PSI	70 PSI	80 PSI	90 PSI	100 PSI	120 PSI	140 PSI	160 PSI	180 PSI	200 PSI	220 PSI	240 PSI	260 PSI	280 PSI	300 PSI
TX-VS1	100	0.015	0.017	0.018	0.020	0.021	0.022	0.023	0.024	0.026	0.028	0.030	0.031	0.032	0.034	0.035	0.036	0.037	0.038
		VF	VF	VF	VF	VF	VF	VF	VF	VF	VF	VF	VF	VF	VF	VF	VF	VF	VF
TX-VS2	100	0.029	0.033	0.037	0.040	0.043	0.045	0.047	0.050	0.054	0.058	0.061	0.064	0.067	0.070	0.073	0.075	0.078	0.080
		VF	VF	VF	VF	VF	VF	VF	VF	VF	VF	VF	VF	VF	VF	VF	VF	VF	VF
TX-VK3	100	0.044	0.050	0.055	0.060	0.064	0.068	0.071	0.075	0.081	0.086	0.092	0.096	0.101	0.105	0.109	0.113	0.117	0.120
		VF	VF	VF	VF	VF	VF	VF	VF	VF	VF	VF	VF	VF	VF	VF	VF	VF	VF
TX-VK4	50	0.058	0.067	0.074	0.080	0.086	0.091	0.096	0.101	0.110	0.118	0.125	0.132	0.139	0.145	0.151	0.157	0.162	0.167
		VF	VF	VF	VF	VF	VF	VF	VF	VF	VF	VF	VF	VF	VF	VF	VF	VF	VF
TX-VK6	50	0.088	0.100	0.111	0.120	0.129	0.137	0.145	0.152	0.165	0.177	0.188	0.199	0.208	0.218	0.226	0.235	0.243	0.251
		VF	VF	VF	VF	VF	VF	VF	VF	VF	VF	VF	VF	VF	VF	VF	VF	VF	VF
TX-VK8	50	0.116	0.133	0.148	0.162	0.174	0.186	0.196	0.207	0.225	0.243	0.259	0.274	0.288	0.301	0.314	0.326	0.338	0.349
		VF	VF	VF	VF	VF	VF	VF	VF	VF	VF	VF	VF	VF	VF	VF	VF	VF	VF
TX-VK10	50	0.145	0.167	0.185	0.202	0.218	0.232	0.246	0.258	0.282	0.303	0.323	0.342	0.360	0.376	0.392	0.408	0.422	0.437
		VF	VF	VF	VF	VF	VF	VF	VF	VF	VF	VF	VF	VF	VF	VF	VF	VF	VF
TX-VK12	50	0.174	0.200	0.223	0.243	0.261	0.279	0.295	0.310	0.338	0.364	0.388	0.410	0.432	0.452	0.471	0.489	0.507	0.524
		VF	VF	VF	VF	VF	VF	VF	VF	VF	VF	VF	VF	VF	VF	VF	VF	VF	VF
TX-VK18	50	0.260	0.300	0.335	0.367	0.396	0.423	0.449	0.473	0.517	0.558	0.597	0.633	0.667	0.699	0.730	0.759	0.788	0.815
		VF	VF	VF	VF	VF	VF	VF	VF	VF	VF	VF	VF	VF	VF	VF	VF	VF	VF
TX-VK26	50	0.376	0.433	0.484	0.530	0.572	0.611	0.648	0.683	0.747	0.807	0.862	0.914	0.963	1.01	1.05	1.10	1.14	1.18
		F	VF	VF	VF	VF	VF	VF	VF	VF	VF	VF	VF	VF	VF	VF	VF	VF	VF

**Note:** Always double check your application rates. Droplet size classification shown are based on ISO 25358. Droplet size is subject to change. Tabulations are based on spraying water at 70°F. See technical information (pages 179–202) for droplet size classification, useful formulas and other technical information.

## HOW TO ORDER

Stainless Steel with color-coding

**T X - V S 4**

Tip Type    Material Code

Brass

**T X - 4**

Tip Type

Ceramic with color-coding

**T X - V K 4**

Tip Type    Material Code

Stainless Steel

**T X - S S 4**

Tip Type    Material Code



## Typical Applications



**FUNGICIDE**  
CONTACT  
**EXCELLENT**  
SYSTEMIC  
**GOOD**



**INSECTICIDE**  
CONTACT  
**EXCELLENT**  
SYSTEMIC  
**GOOD**



**FERTILIZER**  
**EXCELLENT**

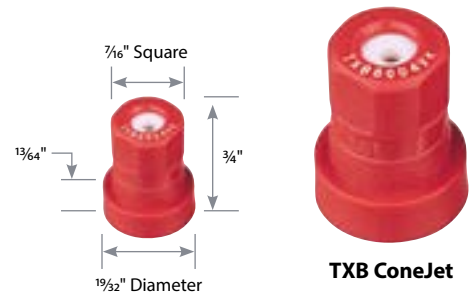
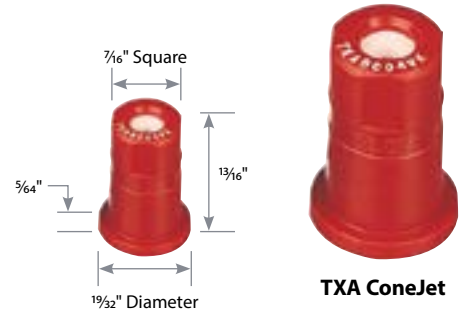

AIR BLAST NOZZLES

## FEATURES

- Use for directed applications in air blast spraying for orchards and vineyards and other specialty crops.
- Maximum operating pressure 300 PSI. Spray angle is 80° at 100 PSI.
- Finely atomized spray pattern provides thorough coverage.
- Longer wear life.
- Resists corrosion.
- Accepts more abrasive pesticide formulation.
- VisiFlo® color-code in a polypropylene body for use with corrosive materials and ceramic insert.
- TXA and TXB compatible with TeeJet cap CP20230 for use on rollovers and threaded nozzle bodies, tighten to a maximum torque of: 100 in-lbs.
- TXA uses 114445A-\*--CELR Quick TeeJet® cap and gasket. Reference page 118 for more information.
- TXB to be used with Albus® caps or equivalent.

## SPRAY PATTERN



## DROPLET SIZE CLASSIFICATION



## RECOMMENDED PRESSURE RANGE



## MATERIALS AVAILABLE



TIP PART NO.	STRAINER MESH SIZE	CAPACITY (GPM)																	
		30 PSI	40 PSI	50 PSI	60 PSI	70 PSI	80 PSI	90 PSI	100 PSI	120 PSI	140 PSI	160 PSI	180 PSI	200 PSI	220 PSI	240 PSI	260 PSI	280 PSI	300 PSI
TX†800050VK	100	0.044	0.050	0.055	0.060	0.064	0.068	0.071	0.075	0.081	0.086	0.092	0.096	0.101	0.105	0.109	0.113	0.117	0.120
		VF	VF	VF	VF	VF	VF	VF	VF	VF	VF	VF	VF	VF	VF	VF	VF	VF	VF
TX†800067VK	50	0.058	0.067	0.074	0.080	0.086	0.091	0.096	0.101	0.110	0.118	0.125	0.132	0.139	0.145	0.151	0.157	0.162	0.167
		VF	VF	VF	VF	VF	VF	VF	VF	VF	VF	VF	VF	VF	VF	VF	VF	VF	VF
TX†8001VK	50	0.088	0.100	0.111	0.120	0.129	0.137	0.145	0.152	0.165	0.177	0.188	0.199	0.208	0.218	0.226	0.235	0.243	0.251
		VF	VF	VF	VF	VF	VF	VF	VF	VF	VF	VF	VF	VF	VF	VF	VF	VF	VF
TX†80015VK	50	0.131	0.150	0.167	0.182	0.196	0.209	0.221	0.232	0.254	0.273	0.291	0.308	0.324	0.339	0.353	0.367	0.380	0.393
		VF	VF	VF	VF	VF	VF	VF	VF	VF	VF	VF	VF	VF	VF	VF	VF	VF	VF
TX†8002VK	50	0.174	0.200	0.223	0.243	0.261	0.279	0.295	0.310	0.338	0.364	0.388	0.410	0.432	0.452	0.471	0.489	0.507	0.524
		VF	VF	VF	VF	VF	VF	VF	VF	VF	VF	VF	VF	VF	VF	VF	VF	VF	VF
TX†8003VK	50	0.260	0.300	0.335	0.367	0.396	0.423	0.449	0.473	0.517	0.558	0.597	0.633	0.667	0.699	0.730	0.759	0.788	0.815
		VF	VF	VF	VF	VF	VF	VF	VF	VF	VF	VF	VF	VF	VF	VF	VF	VF	VF
TX†8004VK	50	0.347	0.400	0.447	0.489	0.528	0.564	0.598	0.630	0.690	0.745	0.796	0.843	0.889	0.932	0.973	1.01	1.05	1.09
		F	VF	VF	VF	VF	VF	VF	VF	VF	VF	VF	VF	VF	VF	VF	VF	VF	VF

AIR BLAST NOZZLES

**Note:** Always double check your application rates. Droplet size classification shown are based on ISO 25358. Droplet size is subject to change. Tabulations are based on spraying water at 70°F. See technical information (pages 179–202) for droplet size classification, useful formulas and other technical information.

†Specify "A" or "B."

## HOW TO ORDER

Ceramic with VisiFlo color-coding

**T X A 8 0 0 4 V K**

Tip	Spray	Capacity	Material
Type	Angle	Size	Code

Ceramic with VisiFlo color-coding

**T X B 8 0 0 4 V K**

Tip	Spray	Capacity	Material
Type	Angle	Size	Code



## Typical Applications



**FUNGICIDE**  
CONTACT  
**EXCELLENT**  
SYSTEMIC  
**GOOD**



**INSECTICIDE**  
CONTACT  
**EXCELLENT**  
SYSTEMIC  
**GOOD**



**FERTILIZER**  
BROADCAST  
**EXCELLENT**



AIR BLAST NOZZLES

## FEATURES

- Use for directed applications in air blast spraying for orchards and vineyards and other specialty crops.
- Produces uniform, 80° hollow cone spray pattern.
- Flow rates are matched to serve as a direct replacement for commonly used non-TeeJet hollow cone spray tips.
- High-quality ceramic orifice provides superior wear life, including high-pressure operation.
- Low profile acetal tip body provides minimal impact with foliage and excellent chemical resistance.
- Snap-fit backup plate provides positive retention when handled in field, but allows for tool-free removal for easy cleaning.
- Best suited for use with TeeJet 98450 series brass rollover valves and TeeJet cap CP20230, tighten to a maximum torque of: 100 in-lbs.
- Compatible with Quick TeeJet® Cap CP114395-1-NYB or 114396-1-NYR (cap, gasket, and O-ring). Reference page 119 for more information.

## SPRAY PATTERN



## DROPLET SIZE CLASSIFICATION



## RECOMMENDED PRESSURE RANGE



30–360 PSI

## MATERIALS AVAILABLE



CERAMIC

# TXR ConeJet® HOLLOW CONE SPRAY

AIR BLAST NOZZLES

TIP PART NO.	STRAINER MESH SIZE	CAPACITY (GPM)																				
		30 PSI	40 PSI	50 PSI	60 PSI	70 PSI	80 PSI	90 PSI	100 PSI	120 PSI	140 PSI	160 PSI	180 PSI	200 PSI	220 PSI	240 PSI	260 PSI	280 PSI	300 PSI	320 PSI	340 PSI	360 PSI
TXR800053VK	100	0.046	0.053	0.059	0.064	0.069	0.073	0.077	0.081	0.089	0.095	0.101	0.107	0.113	0.118	0.123	0.127	0.132	0.136	0.140	0.144	0.148
		VF	VF	VF	VF	VF	VF	VF	VF	VF	VF	VF	VF	VF	VF	VF	VF	VF	VF	VF	VF	VF
TXR800071VK	50	0.062	0.071	0.079	0.086	0.093	0.099	0.105	0.110	0.120	0.129	0.138	0.146	0.153	0.160	0.167	0.174	0.180	0.186	0.192	0.197	0.203
		VF	VF	VF	VF	VF	VF	VF	VF	VF	VF	VF	VF	VF	VF	VF	VF	VF	VF	VF	VF	VF
TXR8001VK	50	0.087	0.100	0.111	0.121	0.131	0.139	0.147	0.155	0.169	0.182	0.194	0.205	0.216	0.226	0.235	0.245	0.253	0.262	0.270	0.278	0.286
		VF	VF	VF	VF	VF	VF	VF	VF	VF	VF	VF	VF	VF	VF	VF	VF	VF	VF	VF	VF	VF
TXR80013VK	50	0.116	0.133	0.148	0.162	0.174	0.186	0.196	0.207	0.225	0.243	0.259	0.274	0.288	0.301	0.314	0.326	0.338	0.349	0.360	0.371	0.381
		VF	VF	VF	VF	VF	VF	VF	VF	VF	VF	VF	VF	VF	VF	VF	VF	VF	VF	VF	VF	VF
TXR80015VK	50	0.131	0.150	0.167	0.182	0.196	0.209	0.221	0.232	0.254	0.273	0.291	0.308	0.324	0.339	0.353	0.367	0.380	0.393	0.405	0.417	0.429
		F	VF	VF	VF	VF	VF	VF	VF	VF	VF	VF	VF	VF	VF	VF	VF	VF	VF	VF	VF	VF
TXR80017VK	50	0.145	0.167	0.185	0.202	0.218	0.232	0.246	0.258	0.282	0.303	0.323	0.342	0.360	0.376	0.392	0.408	0.422	0.437	0.450	0.464	0.476
		F	VF	VF	VF	VF	VF	VF	VF	VF	VF	VF	VF	VF	VF	VF	VF	VF	VF	VF	VF	VF
TXR8002VK	50	0.174	0.200	0.223	0.243	0.261	0.279	0.295	0.310	0.338	0.364	0.388	0.410	0.432	0.452	0.471	0.489	0.507	0.524	0.540	0.556	0.572
		F	F	VF	VF	VF	VF	VF	VF	VF	VF	VF	VF	VF	VF	VF	VF	VF	VF	VF	VF	VF
TXR80028VK	50	0.240	0.275	0.306	0.334	0.359	0.383	0.405	0.426	0.465	0.500	0.533	0.564	0.594	0.621	0.648	0.673	0.697	0.720	0.743	0.765	0.786
		F	F	F	VF	VF	VF	VF	VF	VF	VF	VF	VF	VF	VF	VF	VF	VF	VF	VF	VF	VF
TXR8003VK	50	0.260	0.300	0.335	0.367	0.396	0.423	0.449	0.473	0.517	0.558	0.597	0.633	0.667	0.699	0.730	0.759	0.788	0.815	0.841	0.867	0.892
		F	F	F	VF	VF	VF	VF	VF	VF	VF	VF	VF	VF	VF	VF	VF	VF	VF	VF	VF	VF
TXR80036VK	50	0.309	0.356	0.398	0.435	0.470	0.502	0.532	0.561	0.614	0.663	0.708	0.751	0.791	0.829	0.866	0.901	0.935	0.967	0.999	1.03	1.06
		F	F	F	VF	VF	VF	VF	VF	VF	VF	VF	VF	VF	VF	VF	VF	VF	VF	VF	VF	VF
TXR8004VK	50	0.347	0.400	0.447	0.489	0.528	0.564	0.598	0.630	0.690	0.745	0.796	0.843	0.889	0.932	0.973	1.01	1.05	1.09	1.12	1.16	1.19
		F	F	F	VF	VF	VF	VF	VF	VF	VF	VF	VF	VF	VF	VF	VF	VF	VF	VF	VF	VF
TXR80049VK	50	0.423	0.488	0.545	0.597	0.644	0.688	0.730	0.769	0.842	0.909	0.971	1.03	1.09	1.14	1.19	1.24	1.28	1.33	1.37	1.41	1.45
		F	F	F	F	F	F	VF	VF	VF	VF	VF	VF	VF	VF	VF	VF	VF	VF	VF	VF	VF

**Note:** Always double check your application rates. Droplet size classification shown are based on ISO 25358. Droplet size is subject to change. Tabulations are based on spraying water at 70°F. See technical information (pages 179–202) for droplet size classification, useful formulas and other technical information.

## HOW TO ORDER

Ceramic with color-coding

T X R 8 0 0 3 V K

Tip Type   Spray Angle   Capacity Size   Material Code

Ceramic with color-coding, 100 Tip Pack

T X R 8 0 0 3 V K - 1 0 0 X

Tip Type   Spray Angle   Capacity Size   Material Code



## Typical Applications



**FUNGICIDE**  
CONTACT  
**EXCELLENT**  
SYSTEMIC  
**VERY GOOD**



**INSECTICIDE**  
CONTACT  
**EXCELLENT**  
SYSTEMIC  
**VERY GOOD**



**FERTILIZER**  
**EXCELLENT**



**DRIFT CONTROL**  
**EXCELLENT**

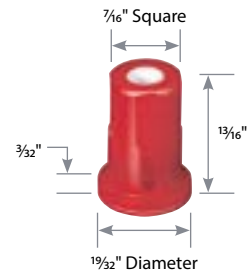

**AITXA ConeJet**

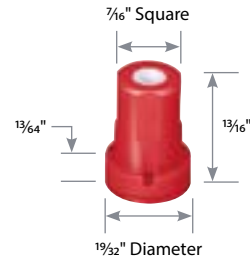

**AITXB ConeJet**



AIR BLAST NOZZLES

## FEATURES

- Hollow cone spray pattern is ideal for air blast and directed spray applications.
- Larger droplets are produced, compared to the standard TX ConeJet, through the use of a Venturi air aspirator resulting in reduced drift and improved canopy penetration.
- Constructed of polypropylene, ceramic and FKM for excellent chemical and wear resistance.
- Removable pre-orifice for fast and easy cleaning.
- AITXA to be used with 114445A-\*-CELR Quick TeeJet® cap.
- AITXB to be used with Albus® caps or equivalent.
- AITXA and AITXB Compatible with TeeJet cap CP20230 for use on rollovers and threaded nozzle bodies, tighten to a maximum torque of: 100 in-lbs.

## SPRAY PATTERN

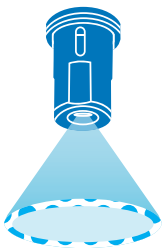

## DROPLET SIZE CLASSIFICATION

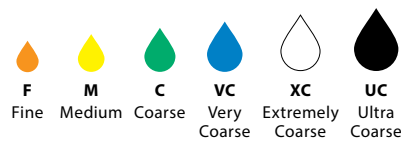

## RECOMMENDED PRESSURE RANGE



## MATERIALS AVAILABLE



TIP PART NO.	STRAINER MESH SIZE	CAPACITY (GPM)														
		60 PSI	70 PSI	80 PSI	90 PSI	100 PSI	120 PSI	140 PSI	160 PSI	180 PSI	200 PSI	220 PSI	240 PSI	260 PSI	280 PSI	300 PSI
AITX†8001VK	50	0.121	0.130	0.138	0.146	0.154	0.168	0.181	0.192	0.203	0.214	0.224	0.233	0.242	0.251	0.260
		XC	VC	VC	VC	VC	C	C	M	M	M	F	F	F	F	F
AITX†80015VK	50	0.181	0.195	0.209	0.221	0.233	0.255	0.275	0.294	0.312	0.328	0.344	0.359	0.374	0.388	0.401
		XC	VC	VC	VC	VC	C	C	M	M	M	F	F	F	F	F
AITX†8002VK	50	0.247	0.195	0.286	0.303	0.320	0.351	0.379	0.405	0.430	0.453	0.476	0.497	0.517	0.537	0.556
		XC	VC	VC	VC	VC	C	C	C	C	M	M	M	M	F	F
AITX†80025VK	50	0.300	0.324	0.347	0.368	0.387	0.424	0.458	0.490	0.519	0.548	0.574	0.600	0.624	0.648	0.670
		XC	XC	XC	XC	VC	VC	VC	VC	C	M	M	M	M	F	F
AITX†8003VK	50	0.360	0.389	0.417	0.443	0.467	0.513	0.554	0.594	0.630	0.665	0.698	0.730	0.760	0.790	0.818
		XC	XC	XC	XC	VC	VC	VC	VC	C	M	M	M	M	F	F
AITX†8004VK	50	0.480	0.519	0.556	0.590	0.623	0.684	0.740	0.792	0.841	0.887	0.931	0.974	1.01	1.05	1.09
		UC	UC	XC	XC	VC	VC	VC	VC	C	C	M	M	M	M	M

**Note:** Always double check your application rates. Droplet size classification shown are based on ISO 25358. Droplet size is subject to change. Tabulations are based on spraying water at 70°F. See technical information (pages 179–202) for droplet size classification, useful formulas and other technical information.

†Specify "A" or "B."

### HOW TO ORDER

Ceramic with VisiFlo color-coding

A I T X A 8 0 0 1 V K

Tip Type    Spray Angle    Capacity Size    Material Code

Ceramic with VisiFlo color-coding

A I T X B 8 0 0 1 V K

Tip Type    Spray Angle    Capacity Size    Material Code



# TeeJet® VISIFLO® FLAT SPRAY

## FEATURES

- Use for directed applications in air blast spraying for orchards and vineyards and other specialty crops.
- Tapered-edge flat spray pattern for uniform coverage.
- VisiFlo color-coded version available with ceramic orifice for long wear life.



## SPRAY PATTERN

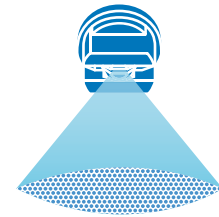

## RECOMMENDED PRESSURE RANGE



30–300 PSI

## MATERIALS AVAILABLE

**VK** CERAMIC

TIP PART NO.	STRAINER MESH SIZE	CAPACITY (GPM)																	
		30 PSI	40 PSI	50 PSI	60 PSI	70 PSI	80 PSI	90 PSI	100 PSI	120 PSI	140 PSI	160 PSI	180 PSI	200 PSI	220 PSI	240 PSI	260 PSI	280 PSI	300 PSI
TP8001VK	100	0.087	0.10	0.11	0.12	0.13	0.14	0.15	0.16	0.17	0.19	0.20	0.21	0.22	0.23	0.24	0.25	0.26	0.27
TP80015VK	100	0.13	0.15	0.17	0.18	0.20	0.21	0.23	0.24	0.26	0.28	0.30	0.32	0.34	0.35	0.37	0.38	0.40	0.41
TP8002VK	50	0.17	0.20	0.22	0.24	0.26	0.28	0.30	0.32	0.35	0.37	0.40	0.42	0.45	0.47	0.49	0.51	0.53	0.55
XR8003VK	50	0.26	0.30	0.34	0.37	0.40	0.42	0.45	0.47	0.52	0.56	0.60	0.64	0.67	0.70	0.73	0.76	0.79	0.82
XR8004VK	50	0.35	0.40	0.45	0.49	0.53	0.57	0.60	0.63	0.69	0.75	0.80	0.85	0.89	0.94	0.98	1.02	1.06	1.10
XR8005VK	50	0.43	0.50	0.56	0.61	0.66	0.71	0.75	0.79	0.87	0.94	1.00	1.06	1.12	1.17	1.22	1.27	1.32	1.37
XR8006VK	50	0.52	0.60	0.67	0.73	0.79	0.85	0.90	0.95	1.04	1.12	1.20	1.27	1.34	1.41	1.47	1.53	1.59	1.64
XR8008VK	50	0.69	0.80	0.89	0.98	1.06	1.13	1.20	1.26	1.39	1.50	1.60	1.70	1.79	1.88	1.96	2.04	2.12	2.19

**Note:** Always double check your application rates. Tabulations are based on spraying water at 70°F. See technical information (pages 179–202) for useful formulas and other technical information.

AIR BLAST NOZZLES

# ConeJet® HOLLOW CONE SPRAY

## Typical Assembly



4514-NY  
Slotted Strainer\*



TXR Tip



CP20230  
TeeJet Cap

\*Use CP20229-NY gasket when 4514-NY Nylon slotted strainer is not used.

### 98450 Double Outlet Rollover

For a complete listing of rollover options, see page 139.

## Typical Applications



**FUNGICIDE**  
CONTACT  
**EXCELLENT**  
SYSTEMIC  
**GOOD**



**INSECTICIDE**  
CONTACT  
**EXCELLENT**  
SYSTEMIC  
**GOOD**



**FERTILIZER**  
**EXCELLENT**

## SPRAY PATTERN

Produced by cores #13, 23, 25, 45 and 46.



DISC	CORE	DISC DIA. (INCH)	CAPACITY (GPM)										ANGLE		
			10 PSI	20 PSI	30 PSI	40 PSI	60 PSI	80 PSI	100 PSI	150 PSI	200 PSI	300 PSI	20 PSI	40 PSI	80 PSI
D1	DC13	.031	—	—	.059	.066	.078	.088	.097	.115	.128	.152	—	51°	62°
D1.5	DC13	.036	—	.057	.067	.075	.088	.098	.110	.127	.142	.167	38°	55°	66°
D2	DC13	.041	—	.064	.075	.08	.10	.11	.12	.14	.16	.18	49°	67°	72°
D3	DC13	.047	—	.071	.08	.09	.11	.12	.13	.16	.18	.20	53°	70°	75°
D4	DC13	.063	.070	.09	.11	.12	.14	.16	.17	.20	.23	.27	69°	79°	83°
D1	DC23	.031	—	.064	.072	.080	.096	.107	.124	.139	.164	—	47°	58°	
D1.5	DC23	.036	—	.064	.076	.086	.103	.117	.130	.155	.175	.210	34°	51°	62°
D2	DC23	.041	—	.078	.092	.10	.13	.14	.16	.19	.21	.25	51°	63°	70°
D3	DC23	.047	.065	.087	.10	.12	.14	.16	.18	.21	.24	.28	58°	69°	75°
D4	DC23	.063	.082	.113	.14	.15	.19	.21	.23	.28	.32	.38	68°	82°	87°
D5	DC23	.078	.095	.13	.16	.18	.22	.25	.28	.34	.38	.46	79°	89°	94°
D6	DC23	.094	.112	.15	.19	.21	.26	.29	.32	.39	.45	.54	84°	93°	98°
D1	DC25	.031	—	.088	.101	.122	.138	.156	.185	.210	.255	—	27°	43°	
D1.5	DC25	.036	—	.118	.135	.162	.185	.205	.245	.280	.33	—	38°	49°	
D2	DC25	.041	—	.12	.14	.16	.19	.22	.25	.29	.34	.41	39°	51°	58°
D3	DC25	.047	.10	.14	.17	.19	.23	.26	.29	.35	.40	.48	52°	61°	67°
D4	DC25	.063	.15	.21	.25	.29	.35	.40	.45	.54	.62	.75	67°	74°	80°
D5	DC25	.078	.18	.25	.30	.35	.42	.48	.54	.65	.75	.90	73°	79°	84°
D6	DC25	.094	.23	.32	.39	.44	.54	.62	.70	.85	.97	1.19	79°	85°	89°
D7	DC25	.109	.26	.37	.45	.52	.63	.73	.81	.98	1.18	1.37	85°	91°	93°
D8	DC25	.125	.31	.43	.53	.61	.75	.89	.97	1.19	1.36	1.68	91°	96°	97°
D10	DC25	.156	.38	.54	.65	.76	.93	1.07	1.21	1.48	1.71	2.1	97°	102°	103°
D12	DC25	.188	.46	.61	.80	.93	1.15	1.32	1.47	1.81	2.09	2.55	103°	109°	112°
D14	DC25	.219	.51	.72	.88	1.03	1.26	1.47	1.65	2.02	2.34	2.89	108°	113°	114°
D1	DC45	.031	—	—	.125	.148	.170	.190	.225	.257	.310	—	22°	34°	
D1.5	DC45	.036	—	.14	.16	.20	.23	.25	.31	.35	.43	—	33°	44°	
D2	DC45	.041	—	.14	.18	.20	.25	.28	.32	.38	.44	.53	32°	46°	55°
D3	DC45	.047	—	.17	.20	.23	.28	.33	.36	.44	.51	.62	40°	53°	60°
D4	DC45	.063	.18	.25	.31	.36	.43	.50	.56	.68	.78	.95	62°	69°	72°
D5	DC45	.078	.23	.32	.39	.45	.55	.64	.71	.86	.99	1.22	67°	73°	76°
D6	DC45	.094	.29	.41	.50	.58	.72	.83	.93	1.15	1.33	1.64	73°	79°	81°
D7	DC45	.109	.33	.48	.59	.68	.84	.97	1.11	1.35	1.57	1.94	81°	86°	87°
D8	DC45	.125	.41	.59	.72	.84	1.04	1.21	1.35	1.68	1.94	2.40	86°	90°	90°
D10	DC45	.156	.54	.77	.94	1.10	1.35	1.57	1.77	2.18	2.50	3.10	90°	93°	93°
D12	DC45	.188	.67	.95	1.17	1.36	1.68	1.95	2.20	2.69	3.11	3.80	97°	100°	102°
D14	DC45	.218	.75	1.07	1.32	1.53	1.89	2.19	2.45	3.00	3.49	4.30	101°	104°	105°
D16	DC45	.250	.86	1.25	1.54	1.79	2.20	2.57	2.89	3.54	4.11	5.20	108°	111°	112°
D1	DC46	.031	—	—	.145	.178	.205	.23	.28	.32	.39	—	13°	15°	
D1.5	DC46	.036	—	—	.213	.260	.300	.33	.41	.46	.56	—	15°	17°	
D2	DC46	.041	—	.24	.27	.33	.37	.42	.50	.57	.68	—	18°	21°	
D3	DC46	.047	—	.23	.28	.32	.39	.45	.51	.61	.70	.86	14°	20°	24°
D4	DC46	.063	.28	.39	.48	.56	.68	.78	.88	1.07	1.23	1.52	23°	29°	33°
D5	DC46	.078	.38	.54	.66	.77	.94	1.10	1.25	1.50	1.73	2.13	33°	39°	42°
D6	DC46	.094	.55	.78	.95	1.10	1.35	1.58	1.73	2.16	2.50	3.06	42°	48°	50°
D7	DC46	.109	—	.98	1.22	1.39	1.72	1.97	2.22	2.73	3.15	3.85	48°	53°	56°
D8	DC46	.125	—	—	1.59	1.84	2.25	2.62	2.93	3.60	4.17	5.05	—	60°	62°
D10	DC46	.156	—	—	2.15	2.48	3.05	3.53	3.96	4.83	5.59	6.80	—	66°	68°

**Note:** Always double check your application rates. Tabulations are based on spraying water at 70°F. See technical information (pages 179–202) for useful formulas and other technical information. **Strainer Note:** For nozzles using orifice disc numbers 1, 1.5 and 2, or core numbers 31 and 33, slotted strainer number 4514-20 equivalent to 25 mesh screen size is required. For all other larger capacity discs and cores, slotted strainer number 4514-32 equivalent to 16 mesh screen size is required.



### CP114444A-\*CE Quick TeeJet Cap

For ceramic disc and core. See pages 90–91 for ordering information.

## RECOMMENDED PRESSURE RANGE



10–300 PSI

## MATERIALS AVAILABLE



POLYMER



HARDENED STAINLESS STEEL



STAINLESS STEEL



BRASS



CERAMIC



NYLON

## HOW TO ORDER

See page 91.

## Typical Applications



**FUNGICIDE**  
CONTACT  
**EXCELLENT**  
SYSTEMIC  
**GOOD**



**INSECTICIDE**  
CONTACT  
**EXCELLENT**  
SYSTEMIC  
**GOOD**



**FERTILIZER**  
**EXCELLENT**

## SPRAY PATTERN

Produced by Cores #31, 33, 35 and 56



## FEATURES

- Ideal for airblast sprayers.
- Produce smaller droplets for thorough coverage with contact pesticides and foliar applications.
- Available in a variety of combinations of disc and core, resulting in different rates and spray angle.
- Maximum spray pressure to 300 PSI.
- Available in different material type to better suit different pressure range and pesticide formulation.
- Ceramic disc and core are more suitable for abrasive and corrosive pesticide and fertilizers.

## ORIFICE DISCS

Available in a variety of sizes and materials. Ceramic for increased wear life, hardened stainless steel, stainless steel and polymer.

### Ceramic Sizes Available

DCER-2 through DCER-8, DCER-10



Ceramic



Hardened  
Stainless Steel



Stainless  
Steel



Polymer

## CORES

Standard cores are made of brass. Also available in ceramic, hardened stainless steel and Nylon. All cores with the exception of ceramic are made with rear "nibs". Make sure core is always placed with the nib facing the nozzle body.

### Ceramic Sizes Available

DC13-CER, DC23-CER, DC25-CER, DC31-CER, DC33-CER, DC35-CER, DC45-CER, DC46-CER, DC56-CER



Ceramic



Hardened  
Stainless Steel



Brass



Nylon



CP18999

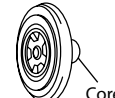

Seal





DISC	CORE	DISC DIA. (INCH)	CAPACITY (GPM)										ANGLE		
			10 PSI	20 PSI	30 PSI	40 PSI	60 PSI	80 PSI	100 PSI	150 PSI	200 PSI	300 PSI	20 PSI	40 PSI	80 PSI
D1	DC31	.031	.08	.11	.13	.15	.18	.20	.23	.27	.31	.37	49°	47°	43°
D1.5	DC31	.036	.10	.14	.17	.19	.23	.26	.29	.35	.40	.48	57°	65°	53°
D2	DC31	.041	.12	.16	.19	.22	.26	.30	.33	.40	.45	.55	62°	63°	61°
D3	DC31	.047	.13	.18	.21	.24	.29	.33	.37	.44	.50	.60	63°	65°	63°
D1	DC33	.031	.09	.11	.12	.14	.17	.20	.22	.26	.30	.37	27°	32°	35°
D1.5	DC33	.036	.12	.15	.17	.19	.23	.26	.30	.36	.41	.50	37°	43°	45°
D2	DC33	.041	.13	.17	.21	.24	.29	.33	.37	.45	.52	.63	45°	52°	55°
D3	DC33	.047	.15	.21	.25	.29	.36	.41	.45	.55	.63	.76	48°	54°	57°
D4	DC33	.063	.20	.28	.34	.39	.47	.54	.60	.73	.83	1.02	50°	56°	61°
D1	DC35	.031	.08	.11	.13	.14	.17	.20	.22	.26	.29	.35	19°	23°	26°
D1.5	DC35	.036	.10	.14	.17	.19	.23	.26	.29	.34	.39	.46	23°	27°	29°
D2	DC35	.041	.14	.18	.24	.25	.30	.34	.37	.45	.51	.60	40°	44°	47°
D3	DC35	.047	.16	.22	.26	.30	.36	.41	.45	.55	.62	.74	45°	50°	52°
D4	DC35	.063	.27	.37	.44	.50	.60	.70	.79	.93	1.1	1.3	68°	70°	71°
D5	DC35	.078	.34	.48	.58	.66	.80	.92	1.0	1.2	1.4	1.7	67°	69°	71°
D2	DC56	.041	—	—	.21	.25	.30	.35	.39	.47	.55	.67	—	14°	17°
D3	DC56	.047	—	—	.29	.34	.41	.48	.53	.65	.75	.92	—	20°	23°
D4	DC56	.063	—	.39	.48	.55	.67	.78	.87	1.06	1.23	1.51	20°	26°	29°
D5	DC56	.078	.38	.54	.66	.76	.93	1.08	1.20	1.47	1.69	2.08	26°	32°	34°
D6	DC56	.094	.55	.78	.95	1.10	1.35	1.55	1.74	2.13	2.46	3.02	34°	39°	41°
D7	DC56	.109	.76	1.07	1.32	1.52	1.86	2.15	2.40	2.94	3.40	4.16	45°	52°	54°
D8	DC56	.125	.96	1.36	1.67	1.93	2.36	2.73	3.05	3.73	4.32	5.28	52°	57°	59°
D10	DC56	.156	1.35	1.91	2.34	2.70	3.31	3.82	4.26	5.22	6.03	7.39	62°	65°	67°

**Note:** Always double check your application rates. Tabulations are based on spraying water at 70°F. See technical information (pages 179–202) for useful formulas and other technical information.

## RECOMMENDED PRESSURE RANGE



10–300 PSI

## MATERIALS AVAILABLE



STAINLESS STEEL



POLYMER



HARDENED STAINLESS STEEL



STAINLESS STEEL



BRASS



CERAMIC



NYLON

For proper assembly and performance, disc and core must both be of like materials. To order orifice Disc, specify Disc number and material.

Ceramic	Hardened Stainless Steel	Stainless Steel	Polymer
D C E R - 2	D 2	D E - 2	D V P - 2

To order core, specify core number and material.

Ceramic	Hardened Stainless Steel	Brass
D C 1 3 - C E R	D C 1 3 - H S S	D C 1 3

Nylon  
D C 1 3 - N Y

Seal Gasket  
C P 1 8 9 9 9 - E P R

**Strainer Note:** For nozzles using orifice disc numbers 1, 1.5 and 2; or core numbers 31 and 33, slotted strainer number 4514-20 equivalent to 25 mesh screen size is required. For all other larger capacity discs and cores, slotted strainer number 4514-32 equivalent to 16 mesh screen size is required.

## Typical Applications



**FERTILIZER  
BROADCAST  
EXCELLENT**



**DRIFT  
CONTROL  
EXCELLENT**



## FEATURES

- Excellent for application of liquid fertilizer on bare ground or in standing crop.
- Three-stream pattern is ideal for directed application.
- Three solid streams of equal velocity and capacity.
- Offered in a variety of sizes for a wide range of application rates.
- VisiFlo® color-coding for easy capacity identification.
- All acetal construction for excellent chemical resistance.
- Solid stream pattern minimizes leaf burn and virtually eliminates drift.
- Equally spaced distribution at 20" height.
- Use with Quick TeeJet® 114443A-\*-CELR cap and gasket.

## SPRAY PATTERN

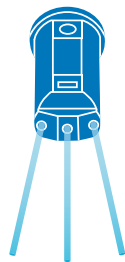

## OPTIMUM SPACING AND SPRAY HEIGHT

HEIGHT	SPACING
20"	20"
30"	30"
40"	40"

## RECOMMENDED PRESSURE RANGE



20–60 PSI

## MATERIALS AVAILABLE



POLYMER

## HOW TO ORDER

Polymer with VisiFlo color-coding

**S J 3 - 0 3 - V P**

Tip  
Type

Capacity  
Size

Material  
Code

TIP PART NO. (STRAINER MESH SIZE)	PSI	CAPACITY ONE TIP IN GPM	APPLICATION RATE FOR 20" SPRAY TIP SPACING										
			3 MPH	4 MPH	5 MPH	6 MPH	8 MPH	10 MPH	12 MPH	14 MPH	16 MPH	18 MPH	20 MPH
SJ3-015-VP (100)	20	0.11	10.9	8.2	6.5	5.4	4.1	3.3	2.7	2.3	2.0	1.8	1.6
	30	0.13	12.9	9.7	7.7	6.4	4.8	3.9	3.2	2.8	2.4	2.1	1.9
	40	0.15	14.9	11.1	8.9	7.4	5.6	4.5	3.7	3.2	2.8	2.5	2.2
	50	0.16	15.8	11.9	9.5	7.9	5.9	4.8	4.0	3.4	3.0	2.6	2.4
	60	0.17	16.8	12.6	10.1	8.4	6.3	5.0	4.2	3.6	3.2	2.8	2.5
SJ3-02-VP (50)	20	0.14	13.9	10.4	8.3	6.9	5.2	4.2	3.5	3.0	2.6	2.3	2.1
	30	0.17	16.8	12.6	10.1	8.4	6.3	5.0	4.2	3.6	3.2	2.8	2.5
	40	0.20	19.8	14.9	11.9	9.9	7.4	5.9	5.0	4.2	3.7	3.3	3.0
	50	0.21	21	15.6	12.5	10.4	7.8	6.2	5.2	4.5	3.9	3.5	3.1
	60	0.22	22	16.3	13.1	10.9	8.2	6.5	5.4	4.7	4.1	3.6	3.3
SJ3-03-VP (50)	20	0.24	24	17.8	14.3	11.9	8.9	7.1	5.9	5.1	4.5	4.0	3.6
	30	0.27	27	20	16.0	13.4	10.0	8.0	6.7	5.7	5.0	4.5	4.0
	40	0.30	30	22	17.8	14.9	11.1	8.9	7.4	6.4	5.6	5.0	4.5
	50	0.33	33	25	19.6	16.3	12.3	9.8	8.2	7.0	6.1	5.4	4.9
	60	0.35	35	26	21	17.3	13.0	10.4	8.7	7.4	6.5	5.8	5.2
SJ3-04-VP (50)	20	0.30	30	22	17.8	14.9	11.1	8.9	7.4	6.4	5.6	5.0	4.5
	30	0.36	36	27	21	17.8	13.4	10.7	8.9	7.6	6.7	5.9	5.3
	40	0.40	40	30	24	19.8	14.9	11.9	9.9	8.5	7.4	6.6	5.9
	50	0.43	43	32	26	21	16.0	12.8	10.6	9.1	8.0	7.1	6.4
	60	0.47	47	35	28	23	17.4	14.0	11.6	10.0	8.7	7.8	7.0
SJ3-05-VP (50)	20	0.36	36	27	21	17.8	13.4	10.7	8.9	7.6	6.7	5.9	5.3
	30	0.45	45	33	27	22	16.7	13.4	11.1	9.5	8.4	7.4	6.7
	40	0.50	50	37	30	25	18.6	14.9	12.4	10.6	9.3	8.3	7.4
	50	0.55	54	41	33	27	20	16.3	13.6	11.7	10.2	9.1	8.2
	60	0.59	58	44	35	29	22	17.5	14.6	12.5	11.0	9.7	8.8
SJ3-06-VP (50)	20	0.42	42	31	25	21	15.6	12.5	10.4	8.9	7.8	6.9	6.2
	30	0.54	53	40	32	27	20	16.0	13.4	11.5	10.0	8.9	8.0
	40	0.60	59	45	36	30	22	17.8	14.9	12.7	11.1	9.9	8.9
	50	0.66	65	49	39	33	25	19.6	16.3	14.0	12.3	10.9	9.8
	60	0.70	69	52	42	35	26	21	17.3	14.9	13.0	11.6	10.4
SJ3-08-VP	20	0.56	55	42	33	28	21	16.6	13.9	11.9	10.4	9.2	8.3
	30	0.72	71	53	43	36	27	21	17.8	15.3	13.4	11.9	10.7
	40	0.80	79	59	48	40	30	24	19.8	17.0	14.9	13.2	11.9
	50	0.88	87	65	52	44	33	26	22	18.7	16.3	14.5	13.1
	60	0.94	93	70	56	47	35	28	23	19.9	17.4	15.5	14.0
SJ3-10-VP	20	0.65	64	48	39	32	24	19.3	16.1	13.8	12.1	10.7	9.7
	30	0.90	89	67	53	45	33	27	22	19.1	16.7	14.9	13.4
	40	1.00	99	74	59	50	37	30	25	21	18.6	16.5	14.9
	50	1.11	110	82	66	55	41	33	27	24	21	18.3	16.5
	60	1.19	118	88	71	59	44	35	29	25	22	19.6	17.7
SJ3-15-VP	20	0.99	98	74	59	49	37	29	25	21	18.4	16.3	14.7
	30	1.24	123	92	74	61	46	37	31	26	23	20	18.4
	40	1.50	149	111	89	74	56	45	37	32	28	25	22
	50	1.68	166	125	100	83	62	50	42	36	31	28	25
	60	1.83	181	136	109	91	68	54	45	39	34	30	27
SJ3-20-VP	20	1.41	140	105	84	70	52	42	35	30	26	23	21
	30	1.75	173	130	104	87	65	52	43	37	32	29	26
	40	2.00	198	149	119	99	74	59	50	42	37	33	30
	50	2.28	226	169	135	113	85	68	56	48	42	38	34
	60	2.49	247	185	148	123	92	74	62	53	46	41	37

**Note:** Always double check your application rates. Tabulations are based on spraying water at 70°F. See technical information (pages 179–202) for useful formulas and other technical information.

FERTILIZER NOZZLES

## Typical Applications



**FERTILIZER  
BROADCAST  
EXCELLENT**



**DRIFT  
CONTROL  
EXCELLENT**



## FEATURES

- The SJ3-VR line of variable rate fertilizer spray tips feature a variable diameter orifice that produces a wide range of flow rates—it's like having five tips in one.
- Allows for a wider range of ground speeds and/or application rates from a single tip for improved productivity.
- Are also ideal for variable rate prescription map applications.
- SJ3-VR tip produces three identical fluid streams for excellent distribution quality in directed applications.
- Solid stream pattern minimizes leaf burn and virtually eliminates drift.
- Acetal body and deflector plate construction for good wear life and chemical resistance.
- Simple, elastomer (EPDM) variable orifice for reliable operation.
- SJ3-VR are intended for use with flow meter based control systems only.
- Multiple capacities available for a wider range of application rates.

## SPRAY PATTERN

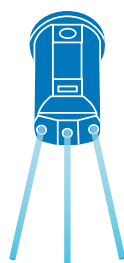

## OPTIMUM SPACING AND SPRAY HEIGHT

HEIGHT	SPACING
15"	15"
20"	20"
30"	30"

\*For best spray distribution maintain a 1:1 ratio of tip height to tip spacing.

## RECOMMENDED PRESSURE RANGE



## MATERIALS AVAILABLE



## HOW TO ORDER

Polymer with VisiFlo® color-coding

**S J 3 - V R - X 2 . 0**

Tip  
Type

Material  
Code

Capacity  
Size

# StreamJet SJ3-VR VARIABLE RATE

TIP PART NO.	PSI	CAPACITY ONE TIP IN GPM	CAPACITY ONE TIP IN OZ/MIN	APPLICATION RATE FOR 15" SPRAY TIP SPACING												APPLICATION RATE FOR 20" SPRAY TIP SPACING											
				3 MPH	4 MPH	5 MPH	6 MPH	8 MPH	10 MPH	12 MPH	14 MPH	16 MPH	18 MPH	20 MPH	3 MPH	4 MPH	5 MPH	6 MPH	8 MPH	10 MPH	12 MPH	14 MPH	16 MPH	18 MPH	20 MPH		
				<b>SJ3-VR-X0.5</b>																							
	20	0.13	17	17.2	12.9	10.3	8.6	6.4	5.1	4.3	3.7	3.2	2.9	2.6	12.9	9.7	7.7	6.4	4.8	3.9	3.2	2.8	2.4	2.1	1.9		
	30	0.16	20	21	15.8	12.7	10.6	7.9	6.3	5.3	4.5	4.0	3.5	3.2	15.8	11.9	9.5	7.9	5.9	4.8	4.0	3.4	3.0	2.6	2.4		
	40	0.18	23	24	17.8	14.3	11.9	8.9	7.1	5.9	5.1	4.5	4.0	3.6	17.8	13.4	10.7	8.9	6.7	5.3	4.5	3.8	3.3	3.0	2.7		
	50	0.21	27	28	21	16.6	13.9	10.4	8.3	6.9	5.9	5.2	4.6	4.2	21	15.6	12.5	10.4	7.8	6.2	5.2	4.5	3.9	3.5	3.1		
	60	0.24	31	32	24	19.0	15.8	11.9	9.5	7.9	6.8	5.9	5.3	4.8	24	17.8	14.3	11.9	8.9	7.1	5.9	5.1	4.5	4.0	3.6		
	70	0.28	36	37	28	22	18.5	13.9	11.1	9.2	7.9	6.9	6.2	5.5	28	21	16.6	13.9	10.4	8.3	6.9	5.9	5.2	4.6	4.2		
	80	0.32	41	42	32	25	21	15.8	12.7	10.6	9.1	7.9	7.0	6.3	32	24	19.0	15.8	11.9	9.5	7.9	6.8	5.9	5.3	4.8		
	90	0.37	47	49	37	29	24	18.3	14.7	12.2	10.5	9.2	8.1	7.3	37	27	22	18.3	13.7	11.0	9.2	7.8	6.9	6.1	5.5		
	100	0.42	54	55	42	33	28	21	16.6	13.9	11.9	10.4	9.2	8.3	42	31	25	21	15.6	12.5	10.4	8.9	7.8	6.9	6.2		
<b>SJ3-VR-X1.0</b>																											
	20	0.21	27	28	21	16.6	13.9	10.4	8.3	6.9	5.9	5.2	4.6	4.2	21	15.6	12.5	10.4	7.8	6.2	5.2	4.5	3.9	3.5	3.1		
	30	0.28	36	37	28	22	18.5	13.9	11.1	9.2	7.9	6.9	6.2	5.5	28	21	16.6	13.9	10.4	8.3	6.9	5.9	5.2	4.6	4.2		
	40	0.35	45	46	35	28	23	17.3	13.9	11.6	9.9	8.7	7.7	6.9	35	26	21	17.3	13.0	10.4	8.7	7.4	6.5	5.8	5.2		
	50	0.43	55	57	43	34	28	21	17.0	14.2	12.2	10.6	9.5	8.5	43	32	26	21	16.0	12.8	10.6	9.1	8.0	7.1	6.4		
	60	0.51	65	67	50	40	34	25	20	16.8	14.4	12.6	11.2	10.1	50	38	30	25	18.9	15.1	12.6	10.8	9.5	8.4	7.6		
	70	0.61	78	81	60	48	40	30	24	20	17.3	15.1	13.4	12.1	60	45	36	30	23	18.1	15.1	12.9	11.3	10.1	9.1		
	80	0.71	91	94	70	56	47	35	28	23	20	17.6	15.6	14.1	70	53	42	35	26	21	17.6	15.1	13.2	11.7	10.5		
	90	0.82	105	108	81	65	54	41	32	27	23	20	18.0	16.2	81	61	49	41	30	24	20	17.4	15.2	13.5	12.2		
	100	0.93	119	123	92	74	61	46	37	31	26	23	20	18.4	92	69	55	46	35	28	23	19.7	17.3	15.3	13.8		
<b>SJ3-VR-X2.0</b>																											
	20	0.55	70	73	54	44	36	27	22	18.2	15.6	13.6	12.1	10.9	54	41	33	27	20	16.3	13.6	11.7	10.2	9.1	8.2		
	30	0.70	90	92	69	55	46	35	28	23	19.8	17.3	15.4	13.9	69	52	42	35	26	21	17.3	14.9	13.0	11.6	10.4		
	40	0.84	108	111	83	67	55	42	33	28	24	21	18.5	16.6	83	62	50	42	31	25	21	17.8	15.6	13.9	12.5		
	50	0.97	124	128	96	77	64	48	38	32	27	24	21	19.2	96	72	58	48	36	29	24	21	18.0	16.0	14.4		
	60	1.11	142	147	110	88	73	55	44	37	31	27	24	22	110	82	66	55	41	33	27	24	21	18.3	16.5		
	70	1.25	160	165	124	99	83	62	50	41	35	31	28	25	124	93	74	62	46	37	31	27	23	21	18.6		
	80	1.38	177	182	137	109	91	68	55	46	39	34	30	27	137	102	82	68	51	41	34	29	26	23	20		
	90	1.51	193	199	149	120	100	75	60	50	43	37	33	30	149	112	90	75	56	45	37	32	28	25	22		
	100	1.64	210	216	162	130	108	81	65	54	46	41	36	32	162	122	97	81	61	49	41	35	30	27	24		

**Note:** Always double check your application rates. Tabulations are based on spraying water at 70°F. See technical information (pages 179–202) for useful formulas and other technical information.

FERTILIZER NOZZLES

## SPEED RANGE FOR VARIOUS APPLICATION RATES

TIP PART NO.	GROUND SPEED RANGE (MPH) FOR 15" SPACING																GROUND SPEED RANGE (MPH) FOR 20" SPACING															
	5 GPA		10 GPA		15 GPA		20 GPA		25 GPA		30 GPA		35 GPA		40 GPA		5 GPA		10 GPA		15 GPA		20 GPA		25 GPA		30 GPA		35 GPA		40 GPA	
	MIN	MAX	MIN	MAX	MIN	MAX	MIN	MAX	MIN	MAX	MIN	MAX	MIN	MAX	MIN	MAX	MIN	MAX	MIN	MAX	MIN	MAX	MIN	MAX	MIN	MAX	MIN	MAX	MIN	MAX	MIN	MAX
<b>SJ3-VR-X0.5</b>	10	33*	5.1	17	3.4	11	2.6	8.3	2.1	6.7	1.7	5.5	1.5	4.8	1.3	4.2	7.7	25	3.9	12	2.6	8.3	1.9	6.2	1.5	5.0	1.3	4.2	1.1	3.6	1.0	3.1
<b>SJ3-VR-X1.0</b>	17	74*	8.3	37*	5.5	25	4.2	18	3.3	15	2.8	12	2.4	11	2.1	9.2	12	55	6.2	28	4.2	18	3.1	14	2.5	11	2.1	9.2	1.8	7.9	1.6	6.9
<b>SJ3-VR-X2.0</b>	-	-	22	65*	15	43*	11	32*	9	26*	7	22	6	19	5	16	-	-	16	49	11	32	8.2	24	6.5	19	5.4	16	4.7	14	4.1	12

\*For safest application, recommended maximum speed is 25 MPH.



## Typical Applications



**FERTILIZER  
BROADCAST  
EXCELLENT**



**DRIFT  
CONTROL  
EXCELLENT**



## FEATURES

- Excellent for application of liquid fertilizer on bare ground or in standing crop.
- Seven-stream pattern is ideal for broadcast application.
- Creates seven identical fluid streams of equal velocity and capacity.
- Excellent spray distribution quality.
- Removable metering orifice for easy cleaning.
- Offered in a variety of sizes for a wide range of application rates.
- VisiFlo® color-coding for easy capacity identification.
- All acetal construction for excellent chemical resistance.
- Solid stream pattern minimizes leaf burn and virtually eliminates drift.
- SJ7A spray tip molded into Quick TeeJet® cap.

## SPRAY PATTERN

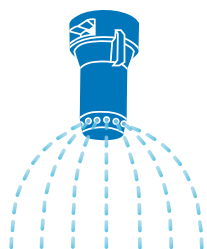

## OPTIMUM SPACING AND SPRAY HEIGHT

HEIGHT	SPACING
20"	20"
30"	30"
40"	40"

## RECOMMENDED PRESSURE RANGE



## MATERIALS AVAILABLE



## HOW TO ORDER

Polymer with VisiFlo color-coding

**S J 7 A - 0 4 - V P**

Tip  
Type

Capacity  
Size

Material  
Code



**50854-NYB**  
Extension Adapter

TIP PART NO. (STRAINER MESH SIZE)	PSI	CAPACITY ONE TIP IN GPM	APPLICATION RATE FOR 20" SPRAY TIP SPACING										
			3 MPH	4 MPH	5 MPH	6 MPH	8 MPH	10 MPH	12 MPH	14 MPH	16 MPH	18 MPH	20 MPH
SJ7A-015-VP (100)	20	0.10	9.9	7.4	5.9	5.0	3.7	3.0	2.5	2.1	1.9	1.7	1.5
	30	0.12	11.9	8.9	7.1	5.9	4.5	3.6	3.0	2.5	2.2	2.0	1.8
	40	0.15	14.9	11.1	8.9	7.4	5.6	4.5	3.7	3.2	2.8	2.5	2.2
	50	0.16	15.8	11.9	9.5	7.9	5.9	4.8	4.0	3.4	3.0	2.6	2.4
	60	0.18	17.8	13.4	10.7	8.9	6.7	5.3	4.5	3.8	3.3	3.0	2.7
SJ7A-02-VP (50)	20	0.14	13.9	10.4	8.3	6.9	5.2	4.2	3.5	3.0	2.6	2.3	2.1
	30	0.17	16.8	12.6	10.1	8.4	6.3	5.0	4.2	3.6	3.2	2.8	2.5
	40	0.20	19.8	14.9	11.9	9.9	7.4	5.9	5.0	4.2	3.7	3.3	3.0
	50	0.23	23	17.1	13.7	11.4	8.5	6.8	5.7	4.9	4.3	3.8	3.4
	60	0.25	25	18.6	14.9	12.4	9.3	7.4	6.2	5.3	4.6	4.1	3.7
SJ7A-03-VP (50)	20	0.22	22	16.3	13.1	10.9	8.2	6.5	5.4	4.7	4.1	3.6	3.3
	30	0.27	27	20	16.0	13.4	10.0	8.0	6.7	5.7	5.0	4.5	4.0
	40	0.30	30	22	17.8	14.9	11.1	8.9	7.4	6.4	5.6	5.0	4.5
	50	0.33	33	25	19.6	16.3	12.3	9.8	8.2	7.0	6.1	5.4	4.9
	60	0.35	35	26	21	17.3	13.0	10.4	8.7	7.4	6.5	5.8	5.2
SJ7A-04-VP (50)	20	0.30	30	22	17.8	14.9	11.1	8.9	7.4	6.4	5.6	5.0	4.5
	30	0.35	35	26	21	17.3	13.0	10.4	8.7	7.4	6.5	5.8	5.2
	40	0.40	40	30	24	19.8	14.9	11.9	9.9	8.5	7.4	6.6	5.9
	50	0.43	43	32	26	21	16.0	12.8	10.6	9.1	8.0	7.1	6.4
	60	0.46	46	34	27	23	17.1	13.7	11.4	9.8	8.5	7.6	6.8
SJ7A-05-VP (50)	20	0.38	38	28	23	18.8	14.1	11.3	9.4	8.1	7.1	6.3	5.6
	30	0.45	45	33	27	22	16.7	13.4	11.1	9.5	8.4	7.4	6.7
	40	0.50	50	37	30	25	18.6	14.9	12.4	10.6	9.3	8.3	7.4
	50	0.54	53	40	32	27	20	16.0	13.4	11.5	10.0	8.9	8.0
	60	0.58	57	43	34	29	22	17.2	14.4	12.3	10.8	9.6	8.6
SJ7A-06-VP (50)	20	0.45	45	33	27	22	16.7	13.4	11.1	9.5	8.4	7.4	6.7
	30	0.54	53	40	32	27	20	16.0	13.4	11.5	10.0	8.9	8.0
	40	0.60	59	45	36	30	22	17.8	14.9	12.7	11.1	9.9	8.9
	50	0.65	64	48	39	32	24	19.3	16.1	13.8	12.1	10.7	9.7
	60	0.70	69	52	42	35	26	21	17.3	14.9	13.0	11.6	10.4
SJ7A-08-VP	20	0.57	56	42	34	28	21	16.9	14.1	12.1	10.6	9.4	8.5
	30	0.72	71	53	43	36	27	21	17.8	15.3	13.4	11.9	10.7
	40	0.80	79	59	48	40	30	24	19.8	17.0	14.9	13.2	11.9
	50	0.87	86	65	52	43	32	26	22	18.5	16.1	14.4	12.9
	60	0.93	92	69	55	46	35	28	23	19.7	17.3	15.3	13.8
SJ7A-10-VP	20	0.71	70	53	42	35	26	21	17.6	15.1	13.2	11.7	10.5
	30	0.90	89	67	53	45	33	27	22	19.1	16.7	14.9	13.4
	40	1.00	99	74	59	50	37	30	25	21	18.6	16.5	14.9
	50	1.09	108	81	65	54	40	32	27	23	20	18.0	16.2
	60	1.16	115	86	69	57	43	34	29	25	22	19.1	17.2
SJ7A-15-VP	20	1.03	102	76	61	51	38	31	25	22	19.1	17.0	15.3
	30	1.29	128	96	77	64	48	38	32	27	24	21	19.2
	40	1.50	149	111	89	74	56	45	37	32	28	25	22
	50	1.64	162	122	97	81	61	49	41	35	30	27	24
	60	1.76	174	131	105	87	65	52	44	37	33	29	26

**Note:** Always double check your application rates. Tabulations are based on spraying water at 70°F. See technical information (pages 179–202) for useful formulas and other technical information.

## Typical Applications



**FERTILIZER  
BROADCAST  
EXCELLENT**



**DRIFT  
CONTROL  
EXCELLENT**



## FEATURES

- The SJ7A-VR line of variable rate fertilizer spray tips feature a variable diameter orifice that produces a wide range of flow rates—it's like having five tips in one.
- Allows for a wider range of ground speeds and/or application rates from a single tip for improved productivity.
- Also ideal for variable rate prescription map applications.
- SJ7A-VR tip produces seven identical fluid streams for excellent distribution quality in broadcast applications.
- Solid stream pattern minimizes leaf burn and virtually eliminates drift.
- Acetal body and deflector plate construction for good wear life and chemical resistance.
- Simple, elastomer (EPDM) variable orifice for reliable operation.
- SJ7A-VR are intended for use with flow meter based control systems only.
- Multiple capacities available for wider range of application rates.

## SPRAY PATTERN

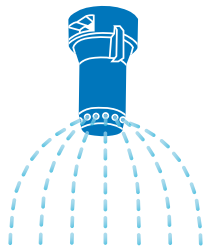

## OPTIMUM SPACING AND SPRAY HEIGHT

HEIGHT	SPACING
20"	20"
30"	30"
40"	40"

\*For best spray distribution maintain a 1:1 ratio of tip height to tip spacing.

## RECOMMENDED PRESSURE RANGE



## MATERIALS AVAILABLE



## HOW TO ORDER

Polymer with VisiFlo® color-coding

**S J 7 A - V R - X 2 . 0**

Tip  
Type

Material  
Code

Capacity  
Size

TIP PART NO.	PSI	CAPACITY ONE TIP IN GPM	CAPACITY ONE TIP IN OZ/MIN	APPLICATION RATE FOR 20" SPRAY TIP SPACING										APPLICATION RATE FOR 30" SPRAY TIP SPACING									
				5 MPH	6 MPH	8 MPH	10 MPH	12 MPH	14 MPH	16 MPH	18 MPH	20 MPH	5 MPH	6 MPH	8 MPH	10 MPH	12 MPH	14 MPH	16 MPH	18 MPH	20 MPH		
SJ7A-VR-X0.5	30	0.16	20	9.5	7.9	5.9	4.8	4.0	3.4	3.0	2.6	2.4	6.3	5.3	4.0	3.2	2.6	2.3	2.0	1.8	1.6		
	40	0.19	24	11.3	9.4	7.1	5.6	4.7	4.0	3.5	3.1	2.8	7.5	6.3	4.7	3.8	3.1	2.7	2.4	2.1	1.9		
	50	0.22	28	13.1	10.9	8.2	6.5	5.4	4.7	4.1	3.6	3.3	8.7	7.3	5.4	4.4	3.6	3.1	2.7	2.4	2.2		
	60	0.26	33	15.4	12.9	9.7	7.7	6.4	5.5	4.8	4.3	3.9	10.3	8.6	6.4	5.1	4.3	3.7	3.2	2.9	2.6		
	70	0.30	38	17.8	14.9	11.1	8.9	7.4	6.4	5.6	5.0	4.5	11.9	9.9	7.4	5.9	5.0	4.2	3.7	3.3	3.0		
	80	0.35	45	21	17.3	13.0	10.4	8.7	7.4	6.5	5.8	5.2	13.9	11.6	8.7	6.9	5.8	5.0	4.3	3.9	3.5		
SJ7A-VR-X1.0	30	0.28	36	16.6	13.9	10.4	8.3	6.9	5.9	5.2	4.6	4.2	11.1	9.2	6.9	5.5	4.6	4.0	3.5	3.1	2.8		
	40	0.35	45	21	17.3	13.0	10.4	8.7	7.4	6.5	5.8	5.2	13.9	11.6	8.7	6.9	5.8	5.0	4.3	3.9	3.5		
	50	0.44	56	26	22	16.3	13.1	10.9	9.3	8.2	7.3	6.5	17.4	14.5	10.9	8.7	7.3	6.2	5.4	4.8	4.4		
	60	0.55	70	33	27	20	16.3	13.6	11.7	10.2	9.1	8.2	22	18.2	13.6	10.9	9.1	7.8	6.8	6.1	5.4		
	70	0.67	86	40	33	25	19.9	16.6	14.2	12.4	11.1	9.9	27	22	16.6	13.3	11.1	9.5	8.3	7.4	6.6		
	80	0.80	102	48	40	30	24	19.8	17.0	14.9	13.2	11.9	32	26	19.8	15.8	13.2	11.3	9.9	8.8	7.9		
SJ7A-VR-X2.0	30	0.70	90	42	35	26	21	17.3	14.9	13.0	11.6	10.4	28	23	17.3	13.9	11.6	9.9	8.7	7.7	6.9		
	40	0.85	109	50	42	32	25	21	18.0	15.8	14.0	12.6	34	28	21	16.8	14.0	12.0	10.5	9.4	8.4		
	50	1.00	128	59	50	37	30	25	21	18.6	16.5	14.9	40	33	25	19.8	16.5	14.1	12.4	11.0	9.9		
	60	1.17	150	69	58	43	35	29	25	22	19.3	17.4	46	39	29	23	19.3	16.5	14.5	12.9	11.6		
	70	1.35	173	80	67	50	40	33	29	25	22	20	53	45	33	27	22	19.1	16.7	14.9	13.4		
	80	1.55	198	92	77	58	46	38	33	29	26	23	61	51	38	31	26	22	19.2	17.1	15.3		

**Note:** Always double check your application rates. Tabulations are based on spraying water at 70°F. See technical information (pages 179–202) for useful formulas and other technical information.

FERTILIZER NOZZLES

### SPEED RANGE FOR VARIOUS APPLICATION RATES

TIP PART NO.	GROUND SPEED RANGE (MPH) FOR 20" SPACING																GROUND SPEED RANGE (MPH) FOR 30" SPACING															
	5 GPA		10 GPA		15 GPA		20 GPA		25 GPA		30 GPA		35 GPA		40 GPA		5 GPA		10 GPA		15 GPA		20 GPA		25 GPA		30 GPA		35 GPA		40 GPA	
	MIN	MAX	MIN	MAX	MIN	MAX	MIN	MAX	MIN	MAX	MIN	MAX	MIN	MAX	MIN	MAX	MIN	MAX	MIN	MAX	MIN	MAX	MIN	MAX	MIN	MAX	MIN	MAX	MIN	MAX		
SJ7A-VR-X0.5	9.5	21	4.8	10	3.2	6.9	2.4	5.2	1.9	4.2	1.6	3.5	1.4	3.0	1.2	2.6	6.3	14	3.2	6.9	2.1	4.6	1.6	3.5	1.3	2.8	1.1	2.3	0.9	2.0	0.8	1.7
SJ7A-VR-X1.0	17	48*	8.3	24	5.5	16	4.2	12	3.3	9.5	2.8	7.9	2.4	6.8	2.1	5.9	11	32	5.5	16	3.7	11	2.8	7.9	2.2	6.3	1.8	5.3	1.6	4.5	1.4	4.0
SJ7A-VR-X2.0	-	-	21	46*	14	31*	10	23	8.3	18	6.9	15	5.9	13	5.2	12	-	-	14	31*	9.2	20	6.9	15	5.5	12	4.6	10	4.0	8.8	3.5	7.7

\*For safest application, recommended maximum speed is 25 MPH.

## Typical Applications



**FERTILIZER  
BROADCAST  
EXCELLENT**



**DRIFT  
CONTROL  
EXCELLENT**



QJ-VR Hose Barb  
Metering Assembly



QJ-VR Metering Assembly



PTC-VR Push-to-Connect  
Metering Assembly

## FEATURES

- The QJ-VR and PTC-VR line of variable rate fertilizer assemblies feature a variable diameter orifice that produces a wide range of flow rates—its like having several metering orifices in one.
- Allows for a wider range of ground speeds and/or application rates from a single size for improved productivity.
- Also ideal for variable rate prescription map applications.
- Both QJ-VR and PTC-VR are ideal for installation on planters and toolbars for liquid fertilizer metering and application.
- PTC-VR features nylon construction for excellent strength and chemical resistance.
- QJ-VR features acetal and nylon construction with choice of nylon or stainless steel hose barbs for strength and excellent chemical resistance.
- Simple, elastomer (EPDM) variable orifice for reliable, long-term operation.

## SPRAY PATTERN



## SIZE OPTIONS

TIP PART NO.	HOSE SIZE (I.D.)				TUBING SIZE (O.D.)		
	1/4"	5/16"	3/8"	1/2"	1/4"	5/16"	3/8"
QJ-VR-X0.5	•	•	•				
QJ-VR-X1.0	•	•	•				
QJ-VR-X2.0			•	•			
PTC-VR-X0.5					•	•	•
PTC-VR-X1.0					•	•	•
PTC-VR-X2.0						•	•

**Note:** 1/4" and 5/16" hose barb sizes offered in stainless steel only. 3/8" and 1/2" hose barbs offered in choice of stainless steel or nylon.

## RECOMMENDED PRESSURE RANGE



10–100 PSI

## MATERIALS AVAILABLE



POLYMER

## HOW TO ORDER

Quick TeeJet® Variable Rate Metering Assembly  
(no Hose Barb)

Q J - V R - X 2 . 0

3/8" Push-to-Connect Variable Rate  
Metering Assembly

P T C - V R - X 1 . 0 - 3 / 8

1/4" Stainless Steel Hose Barb Variable Rate  
Metering Assembly

Q J - V R - X 1 . 0 - 1 / 4 - S S

1/4" Push-to-Connect Variable Rate Metering Assembly  
with 10 PSI Diaphragm Check Valve

P T C - V R - X 1 . 0 - 1 / 4 - 1 0





# QJ-VR & PTC-VR VARIABLE RATE

FERTILIZER NOZZLES

TIP PART NO.	PSI	CAPACITY ONE TIP IN GPM	CAPACITY ONE TIP IN OZ/MIN	GROUND SPEED RANGE (MPH) FOR 20" SPACING										GROUND SPEED RANGE (MPH) FOR 30" SPACING											
				3 MPH	4 MPH	5 MPH	6 MPH	8 MPH	10 MPH	12 MPH	14 MPH	16 MPH	18 MPH	20 MPH	3 MPH	4 MPH	5 MPH	6 MPH	8 MPH	10 MPH	12 MPH	14 MPH	16 MPH	18 MPH	20 MPH
QJ-VR-X0.5 PTC-VR-X0.5	10	0.09	12	8.9	6.7	5.3	4.5	3.3	2.7	2.2	1.9	1.7	1.5	1.3	5.9	4.5	3.6	3.0	2.2	1.8	1.5	1.3	1.1	1.0	0.9
	20	0.13	17	12.9	9.7	7.7	6.4	4.8	3.9	3.2	2.8	2.4	2.1	1.9	8.6	6.4	5.1	4.3	3.2	2.6	2.1	1.8	1.6	1.4	1.3
	30	0.17	22	16.8	12.6	10.1	8.4	6.3	5.0	4.2	3.6	3.2	2.8	2.5	11.2	8.4	6.7	5.6	4.2	3.4	2.8	2.4	2.1	1.9	1.7
	40	0.21	27	21	15.6	12.5	10.4	7.8	6.2	5.2	4.5	3.9	3.5	3.1	13.9	10.4	8.3	6.9	5.2	4.2	3.5	3.0	2.6	2.3	2.1
	50	0.24	31	24	17.8	14.3	11.9	8.9	7.1	5.9	5.1	4.5	4.0	3.6	15.8	11.9	9.5	7.9	5.9	4.8	4.0	3.4	3.0	2.6	2.4
	60	0.29	37	29	22	17.2	14.4	10.8	8.6	7.2	6.2	5.4	4.8	4.3	19.1	14.4	11.5	9.6	7.2	5.7	4.8	4.1	3.6	3.2	2.9
	70	0.34	44	34	25	20	16.8	12.6	10.1	8.4	7.2	6.3	5.6	5.0	22	16.8	13.5	11.2	8.4	6.7	5.6	4.8	4.2	3.7	3.4
	80	0.40	51	40	30	24	19.8	14.9	11.9	9.9	8.5	7.4	6.6	5.9	26	19.8	15.8	13.2	9.9	7.9	6.6	5.7	5.0	4.4	4.0
	90	0.46	59	46	34	27	23	17.1	13.7	11.4	9.8	8.5	7.6	6.8	30	23	18.2	15.2	11.4	9.1	7.6	6.5	5.7	5.1	4.6
	100	0.54	69	53	40	32	27	20	16.0	13.4	11.5	10.0	8.9	8.0	36	27	21	17.8	13.4	10.7	8.9	7.6	6.7	5.9	5.3
QJ-VR-X1.0 PTC-VR-X1.0	10	0.13	17	12.9	9.7	7.7	6.4	4.8	3.9	3.2	2.8	2.4	2.1	1.9	8.6	6.4	5.1	4.3	3.2	2.6	2.1	1.8	1.6	1.4	1.3
	20	0.21	27	21	15.6	12.5	10.4	7.8	6.2	5.2	4.5	3.9	3.5	3.1	13.9	10.4	8.3	6.9	5.2	4.2	3.5	3.0	2.6	2.3	2.1
	30	0.28	36	28	21	16.6	13.9	10.4	8.3	6.9	5.9	5.2	4.6	4.2	18.5	13.9	11.1	9.2	6.9	5.5	4.6	4.0	3.5	3.1	2.8
	40	0.35	45	35	26	21	17.3	13.0	10.4	8.7	7.4	6.5	5.8	5.2	23	17.3	13.9	11.6	8.7	6.9	5.8	5.0	4.3	3.9	3.5
	50	0.44	56	44	33	26	22	16.3	13.1	10.9	9.3	8.2	7.3	6.5	29	22	17.4	14.5	10.9	8.7	7.3	6.2	5.4	4.8	4.4
	60	0.53	68	52	39	31	26	19.7	15.7	13.1	11.2	9.8	8.7	7.9	35	26	21	17.5	13.1	10.5	8.7	7.5	6.6	5.8	5.2
	70	0.64	82	63	48	38	32	24	19.0	15.8	13.6	11.9	10.6	9.5	42	32	25	21	15.8	12.7	10.6	9.1	7.9	7.0	6.3
	80	0.77	99	76	57	46	38	29	23	19.1	16.3	14.3	12.7	11.4	51	38	30	25	19.1	15.2	12.7	10.9	9.5	8.5	7.6
	90	0.90	115	89	67	53	45	33	27	22	19.1	16.7	14.9	13.4	59	45	36	30	22	17.8	14.9	12.7	11.1	9.9	8.9
	100	1.03	132	102	76	61	51	38	31	25	22	19.1	17.0	15.3	68	51	41	34	25	20	17.0	14.6	12.7	11.3	10.2
QJ-VR-X2.0 PTC-VR-X2.0	10	0.38	49	38	28	23	18.8	14.1	11.3	9.4	8.1	7.1	6.3	5.6	25	18.8	15.0	12.5	9.4	7.5	6.3	5.4	4.7	4.2	3.8
	20	0.57	73	56	42	34	28	21	16.9	14.1	12.1	10.6	9.4	8.5	38	28	23	18.8	14.1	11.3	9.4	8.1	7.1	6.3	5.6
	30	0.73	93	72	54	43	36	27	22	18.1	15.5	13.6	12.0	10.8	48	36	29	24	18.1	14.5	12.0	10.3	9.0	8.0	7.2
	40	0.87	111	86	65	52	43	32	26	22	18.5	16.1	14.4	12.9	57	43	34	29	22	17.2	14.4	12.3	10.8	9.6	8.6
	50	1.03	132	102	76	61	51	38	31	25	22	19.1	17.0	15.3	68	51	41	34	25	20	17.0	14.6	12.7	11.3	10.2
	60	1.20	154	119	89	71	59	45	36	30	25	22	19.8	17.8	79	59	48	40	30	24	19.8	17.0	14.9	13.2	11.9
	70	1.40	179	139	104	83	69	52	42	35	30	26	23	21	92	69	55	46	35	28	23	19.8	17.3	15.4	13.9
	80	1.61	206	159	120	96	80	60	48	40	34	30	27	24	106	80	64	53	40	32	27	23	19.9	17.7	15.9
	90	1.84	236	182	137	109	91	68	55	46	39	34	30	27	121	91	73	61	46	36	30	26	23	20	18.2
	100	2.07	265	205	154	123	102	77	61	51	44	38	34	31	137	102	82	68	51	41	34	29	26	23	20

**Note:** Always double check your application rates. Tabulations are based on spraying water at 70°F. See technical information (pages 179–202) for useful formulas and other technical information.

## SPEED RANGE FOR VARIOUS APPLICATION RATES

TIP PART NO.	GROUND SPEED RANGE (MPH) FOR 20" SPACING												GROUND SPEED RANGE (MPH) FOR 30" SPACING																			
	5 GPA		10 GPA		15 GPA		20 GPA		25 GPA		30 GPA		35 GPA		40 GPA		5 GPA		10 GPA		15 GPA		20 GPA		25 GPA		30 GPA		35 GPA		40 GPA	
	MIN	MAX	MIN	MAX	MIN	MAX	MIN	MAX	MIN	MAX	MIN	MAX	MIN	MAX	MIN	MAX	MIN	MAX	MIN	MAX	MIN	MAX	MIN	MAX	MIN	MAX	MIN	MAX	MIN	MAX		
QJ-VR-X0.5 PTC-VR-X0.5	5.3	32*	2.7	16	1.8	11	1.3	8.0	1.1	6.4	0.9	5.3	0.8	4.6	0.7	4.0	3.6	21	1.8	11	1.2	7.1	0.9	5.3	0.7	4.3	0.6	3.6	0.5	3.1	0.4	2.7
QJ-VR-X1.0 PTC-VR-X1.0	7.7	61*	3.9	31*	2.6	20	1.9	15	1.5	12	1.3	10	1.1	8.7	1.0	7.6	5.1	41*	2.6	20	1.7	14	1.3	10	1.0	8	0.9	7	0.7	6	0.6	5.1
QJ-VR-X2.0 PTC-VR-X2.0	23	123*	11	61*	7.5	41*	5.6	31*	4.5	25	3.8	20	3.2	18	2.8	15	15	82*	7.5	41*	5.0	27*	3.8	20	3.0	16	2.5	14	2.1	12	1.9	10

\*For safest application, recommended maximum speed is 25 MPH.

## Typical Applications



**FERTILIZER**  
DIRECTED  
**EXCELLENT**

Flow Regulators are usually mounted behind cultivator shanks for the subsurface application of liquid fertilizers and soil fumigants. They are also used for above-ground streaming applications.



**CP1322**  
1/4TT Body



**5053**  
Strainer



**CP4916**  
Orifice Plate



**CP4928**  
Adapter 1/8" NPT (F)  
Outlet



**CP1325**  
Cap



**Note:** Always insert orifice plate with side marked with number facing the outlet.  
MATERIAL: Stainless Steel

## TIP STRAINER MESH RECOMMENDATION

FOR ORIFICE SIZE	USE MESH SIZE
15 and Smaller	200
16–39	100
40–70	50
72 and Larger	—

To determine the orifice plates you need, use the following equations:

$$\text{GPM (Per Nozzle)} = \frac{\text{GPA} \times \text{MPH} \times \text{W}}{5,940}$$

$$\text{GPM} = \frac{5,940 \times \text{GPM (Per Nozzle)}}{\text{MPH} \times \text{W}}$$

Tabulated flow rates are for spraying water into air at atmospheric pressure. If your application creates backpressure, or if spraying into a liquid, measure and calibrate to ensure proper application rates. For spraying solutions other than water, see page 185 for conversion factors.

- W = Nozzle spacing (in inches) for broadcast spraying.
- = Spray width (in inches) for single nozzle, band spraying or boomless spraying.
- = Row spacing (in inches) divided by the number of nozzles per row for directed spraying.

ORIFICE PLATE PART NO.	CAPACITY (GPM)						
	5 PSI	10 PSI	20 PSI	30 PSI	40 PSI	50 PSI	60 PSI
CP4916-008	0.003	0.004	0.006	0.007	0.008	0.009	0.010
CP4916-10	0.005	0.007	0.009	0.011	0.013	0.015	0.016
CP4916-12	0.007	0.010	0.013	0.016	0.019	0.021	0.023
CP4916-14	0.009	0.013	0.018	0.022	0.025	0.028	0.031
CP4916-15	0.010	0.015	0.021	0.025	0.029	0.032	0.036
CP4916-16	0.012	0.017	0.023	0.029	0.033	0.037	0.040
CP4916-18	0.015	0.021	0.030	0.036	0.042	0.047	0.051
CP4916-20	0.018	0.026	0.037	0.045	0.052	0.058	0.064
CP4916-22	0.022	0.031	0.043	0.053	0.061	0.068	0.075
CP4916-24	0.026	0.037	0.052	0.064	0.074	0.083	0.091
CP4916-25	0.028	0.040	0.056	0.068	0.079	0.088	0.097
CP4916-26	0.030	0.043	0.061	0.074	0.086	0.096	0.105
CP4916-27	0.032	0.046	0.064	0.079	0.091	0.102	0.111
CP4916-28	0.035	0.049	0.069	0.085	0.098	0.110	0.120
CP4916-29	0.038	0.054	0.076	0.094	0.108	0.121	0.132
CP4916-30	0.040	0.057	0.081	0.099	0.114	0.127	0.140
CP4916-31	0.043	0.062	0.087	0.107	0.123	0.138	0.151
CP4916-32	0.048	0.068	0.095	0.117	0.135	0.151	0.165
CP4916-34	0.052	0.074	0.104	0.127	0.147	0.164	0.180
CP4916-35	0.056	0.079	0.111	0.136	0.157	0.176	0.192
CP4916-37	0.061	0.086	0.122	0.149	0.172	0.192	0.211
CP4916-39	0.068	0.096	0.135	0.165	0.191	0.214	0.234
CP4916-40	0.072	0.102	0.144	0.177	0.204	0.228	0.250
CP4916-41	0.075	0.106	0.149	0.183	0.211	0.236	0.258
CP4916-43	0.082	0.116	0.163	0.200	0.231	0.258	0.283
CP4916-45	0.088	0.125	0.177	0.217	0.250	0.280	0.306
CP4916-46	0.095	0.135	0.191	0.234	0.270	0.302	0.331

**Note:** Always double check your application rates. Tabulations are based on spraying water at 70°F. See technical information (pages 179–202) for useful formulas and other technical information.

ORIFICE PLATE PART NO.	CAPACITY (GPM)						
	5 PSI	10 PSI	20 PSI	30 PSI	40 PSI	50 PSI	60 PSI
CP4916-47	0.097	0.138	0.194	0.238	0.275	0.307	0.337
CP4916-48	0.101	0.143	0.202	0.248	0.286	0.320	0.350
CP4916-49	0.104	0.148	0.209	0.255	0.295	0.330	0.361
CP4916-51	0.116	0.165	0.233	0.285	0.329	0.368	0.403
CP4916-52	0.118	0.168	0.237	0.290	0.335	0.375	0.410
CP4916-54	0.127	0.180	0.255	0.312	0.360	0.402	0.441
CP4916-55	0.133	0.189	0.267	0.326	0.377	0.421	0.462
CP4916-57	0.141	0.200	0.283	0.346	0.400	0.447	0.490
CP4916-59	0.153	0.217	0.306	0.375	0.433	0.484	0.530
CP4916-61	0.165	0.233	0.330	0.404	0.466	0.521	0.571
CP4916-63	0.174	0.246	0.347	0.425	0.491	0.549	0.601
CP4916-65	0.185	0.261	0.369	0.452	0.522	0.584	0.639
CP4916-67	0.196	0.278	0.392	0.481	0.555	0.621	0.680
CP4916-68	0.203	0.287	0.405	0.496	0.573	0.641	0.702
CP4916-70	0.216	0.306	0.433	0.530	0.612	0.684	0.750
CP4916-72	0.226	0.320	0.453	0.554	0.640	0.716	0.784
CP4916-73	0.233	0.330	0.467	0.572	0.660	0.738	0.808
CP4916-75	0.245	0.347	0.491	0.601	0.694	0.776	0.850
CP4916-78	0.272	0.385	0.544	0.667	0.770	0.861	0.943
CP4916-80	0.280	0.397	0.561	0.687	0.793	0.887	0.971
CP4916-81	0.290	0.411	0.581	0.711	0.821	0.918	1.01
CP4916-83	0.317	0.449	0.634	0.777	0.897	1.00	1.10
CP4916-86	0.332	0.470	0.664	0.813	0.939	1.05	1.15
CP4916-89	0.346	0.490	0.693	0.849	0.980	1.10	1.20
CP4916-91	0.369	0.523	0.739	0.905	1.05	1.17	1.28
CP4916-93	0.387	0.547	0.774	0.947	1.09	1.22	1.34
CP4916-95	0.404	0.572	0.808	0.990	1.14	1.28	1.40

ORIFICE PLATE PART NO.	CAPACITY (GPM)						
	5 PSI	10 PSI	20 PSI	30 PSI	40 PSI	50 PSI	60 PSI
CP4916-98	0.442	0.625	0.884	1.08	1.25	1.40	1.53
CP4916-103	0.461	0.653	0.923	1.13	1.31	1.46	1.60
CP4916-107	0.518	0.733	1.04	1.27	1.47	1.64	1.79
CP4916-110	0.548	0.775	1.10	1.34	1.55	1.73	1.90
CP4916-115	0.605	0.855	1.21	1.48	1.71	1.91	2.09
CP4916-120	0.629	0.890	1.26	1.54	1.78	1.99	2.18
CP4916-125	0.693	0.980	1.39	1.70	1.96	2.19	2.40
CP4916-128	0.721	1.02	1.44	1.77	2.04	2.28	2.50
CP4916-132	0.774	1.10	1.55	1.90	2.19	2.45	2.68
CP4916-136	0.840	1.19	1.68	2.06	2.38	2.66	2.91
CP4916-140	0.894	1.27	1.79	2.19	2.53	2.83	3.10
CP4916-144	0.926	1.31	1.85	2.27	2.62	2.93	3.21
CP4916-147	0.953	1.35	1.91	2.33	2.70	3.01	3.30
CP4916-151	1.04	1.47	2.08	2.55	2.94	3.29	3.60
CP4916-156	1.10	1.55	2.20	2.69	3.11	3.47	3.80
CP4916-161	1.15	1.63	2.31	2.83	3.27	3.65	4.00
CP4916-166	1.21	1.72	2.43	2.97	3.43	3.84	4.20
CP4916-170	1.30	1.84	2.61	3.19	3.69	4.12	4.51
CP4916-172	1.36	1.92	2.71	3.32	3.84	4.29	4.70
CP4916-177	1.41	2.00	2.83	3.46	4.00	4.47	4.90
CP4916-182	1.47	2.08	2.95	3.61	4.17	4.66	5.10
CP4916-187	1.56	2.21	3.12	3.82	4.41	4.93	5.40
CP4916-196	1.73	2.45	3.46	4.24	4.90	5.47	6.00
CP4916-205	1.88	2.65	3.75	4.59	5.31	5.93	6.50
CP4916-218	2.11	2.98	4.21	5.16	5.96	6.66	7.30
CP4916-234	2.45	3.47	4.91	6.01	6.94	7.76	8.50
CP4916-250	2.83	4.00	5.66	6.93	8.00	8.94	9.80

**Note:** Always double check your application rates. Tabulations are based on spraying water at 70°F. See technical information (pages 179–202) for useful formulas and other technical information.

## HOW TO ORDER

CP4916-008

Orifice Plate

Capacity Size



## Stainless Steel for Banding Fertilizers

- Permits banding fluids at high-rig speeds.
- Large orifices with no internal obstructions permit non-clogging suspension applications.
- Lower drift potential.
- See page 185 for liquid density conversion factors.
- For TP tips use Quick TeeJet® cap and gasket 25608-1-NYR.



TIP PART NO.	PSI	CAPACITY ONE NOZZLE IN GPM	APPLICATION RATE FOR 30" SPRAY NOZZLE SPACING									
			4 MPH	6 MPH	8 MPH	10 MPH	12 MPH	14 MPH	16 MPH	18 MPH	20 MPH	
TP0001-SS	10	0.050	2.5	1.7	1.2	0.99	0.83	0.71	0.62	0.55	0.50	
	20	0.071	3.5	2.3	1.8	1.4	1.2	1.0	0.88	0.78	0.70	
	30	0.087	4.3	2.9	2.2	1.7	1.4	1.2	1.1	0.96	0.86	
	40	0.10	5.0	3.3	2.5	2.0	1.7	1.4	1.2	1.1	0.99	
TP00015-SS	10	0.075	3.7	2.5	1.9	1.5	1.2	1.1	0.93	0.83	0.74	
	20	0.11	5.4	3.6	2.7	2.2	1.8	1.6	1.4	1.2	1.1	
	30	0.13	6.4	4.3	3.2	2.6	2.1	1.8	1.6	1.4	1.3	
	40	0.15	7.4	5.0	3.7	3.0	2.5	2.1	1.9	1.7	1.5	
H1/4U-SS0002 TP0002-SS	10	0.10	5.0	3.3	2.5	2.0	1.7	1.4	1.2	1.1	0.99	
	20	0.14	6.9	4.6	3.5	2.8	2.3	2.0	1.7	1.5	1.4	
	30	0.17	8.4	5.6	4.2	3.4	2.8	2.4	2.1	1.9	1.7	
	40	0.20	9.9	6.6	5.0	4.0	3.3	2.8	2.5	2.2	2.0	
H1/4U-SS0003 TP0003-SS	10	0.15	7.4	5.0	3.7	3.0	2.5	2.1	1.9	1.7	1.5	
	20	0.21	10.4	6.9	5.2	4.2	3.5	3.0	2.6	2.3	2.1	
	30	0.26	12.9	8.6	6.4	5.1	4.3	3.7	3.2	2.9	2.6	
	40	0.30	14.9	9.9	7.4	5.9	5.0	4.2	3.7	3.3	3.0	
H1/4U-SS0004 TP0004-SS	10	0.20	9.9	6.6	5.0	4.0	3.3	2.8	2.5	2.2	2.0	
	20	0.28	13.9	9.2	6.9	5.5	4.6	4.0	3.5	3.1	2.8	
	30	0.35	17.3	11.6	8.7	6.9	5.8	5.0	4.3	3.9	3.5	
	40	0.40	19.8	13.2	9.9	7.9	6.6	5.7	5.0	4.4	4.0	
H1/4U-SS0006 TP0006-SS	10	0.30	14.9	9.9	7.4	5.9	5.0	4.2	3.7	3.3	3.0	
	20	0.42	21	13.9	10.4	8.3	6.9	5.9	5.2	4.6	4.2	
	30	0.52	26	17.2	12.9	10.3	8.6	7.4	6.4	5.7	5.1	
	40	0.60	30	19.8	14.9	11.9	9.9	8.5	7.4	6.6	5.9	
H1/4U-SS0008 TP0008-SS	10	0.40	19.8	13.2	9.9	7.9	6.6	5.7	5.0	4.4	4.0	
	20	0.57	28	18.8	14.1	11.3	9.4	8.1	7.1	6.3	5.6	
	30	0.69	34	23	17.1	13.7	11.4	9.8	8.5	7.6	6.8	
	40	0.80	40	26	19.8	15.8	13.2	11.3	9.9	8.8	7.9	
H1/4U-SS0010 TP0010-SS	10	0.50	25	16.5	12.4	9.9	8.3	7.1	6.2	5.5	5.0	
	20	0.71	35	23	17.6	14.1	11.7	10.0	8.8	7.8	7.0	
	30	0.87	43	29	22	17.2	14.4	12.3	10.8	9.6	8.6	
	40	1.00	50	33	25	19.8	16.5	14.1	12.4	11.0	9.9	
H1/4U-SS0015 TP0015-SS	10	0.75	37	25	19	14.9	12.4	10.6	9.3	8.3	7.4	
	20	1.06	52	35	26	21	17.5	15.0	13.1	11.7	10.5	
	30	1.30	64	43	32	26	21	18.4	16.1	14.3	12.9	
	40	1.50	74	50	37	30	25	21	18.6	16.5	14.9	
H1/4U-SS0020 TP0020-SS	10	1.00	50	33	25	19.8	16.5	14.1	12.4	11.0	9.9	
	20	1.41	70	47	35	28	23	19.9	17.4	15.5	14.0	
	30	1.73	86	57	43	34	29	24	21	19.0	17.1	
	40	2.00	99	66	50	40	33	28	25	22	19.8	
H1/4U-SS0030 TP0030-SS	10	1.50	74	50	37	30	25	21	18.6	16.5	14.9	
	20	2.12	105	70	52	42	35	30	26	23	21	
	30	2.60	129	86	64	51	43	37	32	29	26	
	40	3.00	149	99	74	59	50	42	37	33	30	
H1/4U-SS0040 TP0040-SS	10	2.00	99	66	50	40	33	28	25	22	20	
	20	2.83	140	93	70	56	47	40	35	31	28	
	30	3.46	171	114	86	69	57	49	43	38	34	
	40	4.00	198	132	99	79	66	57	50	44	40	
H1/4U-SS0050	10	2.50	124	83	62	50	41	35	31	28	25	
	20	3.54	175	117	88	70	58	50	44	39	35	
	30	4.33	214	143	107	86	71	61	54	48	43	
	40	5.00	248	165	124	99	83	71	62	55	50	
H1/4U-SS0060	10	3.00	149	99	74	59	50	42	37	33	30	
	20	4.24	210	140	105	84	70	60	52	47	42	
	30	5.20	257	172	129	103	86	74	64	57	51	
	40	6.00	297	198	149	119	99	85	74	66	59	

**Note:** Always double check your application rates. Tabulations are based on spraying water at 70°F. See technical information (pages 179–202) for useful formulas and other technical information.

## Typical Applications



**FERTILIZER DIRECTED**  
**EXCELLENT**



**DRIFT CONTROL**  
**EXCELLENT**

## SPRAY PATTERN

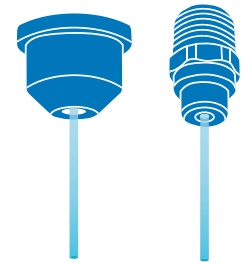

## MATERIALS AVAILABLE

**SS** STAINLESS STEEL

## HOW TO ORDER

Stainless Steel  
**H 1 / 4 U - S S 0 0 1 0**  
 Tip Type      Material Code      Capacity Size

FERTILIZER NOZZLES

# TeeJet® TANK RINSING



## 55270

- Rotating head driven by the flow of the rinsing liquid through multiple round spray orifices.
- Solid stream sprays are precisely positioned to provide effective internal wetting and cleaning of tank surface.
- Removable retainer and rotating body allows for disassembly and cleaning.
- Provides 360° coverage of inside surface of tank for tank diameters up to 10'.
- Self-lubricating and self-flushing design.

- Materials: Body: black POM (acetal); Fasteners: stainless steel.
- Recommended operating pressure 10–50 PSI.
- Mounting connection: ½" or ¾" NPT or BSPT (F).

### Typical Application

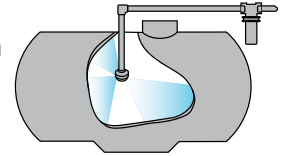

NOZZLE NUMBER	CAPACITY (GPM)					TYPE OF COVERAGE	SPRAY ANGLE
	10 PSI	20 PSI	30 PSI	40 PSI	50 PSI		
55270-1/2-11-POM	5.9	7.9	9.4	11.0	12.4		360°
B55270-1/2-11-POM							
55270-3/4-18-POM							
B55270-3/4-18-POM	9.0	12.7	15.6	18.0	20.0		



## D41892

- The rotary tank rinsing nozzle is used for rinsing the insides of chemical containers and spray tanks up to 6.5' in diameter.
- Available with ½" NPT or BSPT (F) connections.

- Significant lower rotating speed at approximately 15% of typical speed, results in faster and more thorough cleaning of tank surface.
- Self-cleaning sliding bearing.
- Body and inserts are made of POM (Acetal).
- Nozzle fits in 1½" opening.
- Recommended operating pressure 30–60 PSI with a maximum pressure 115 PSI.

NOZZLE NUMBER	CAPACITY (GPM)				
	20 PSI	30 PSI	40 PSI	50 PSI	60 PSI
D41892-(B)1/2-POM-6	4.0	4.9	5.7	6.4	7.0

# TeeJet® CONTAINER RINSING



## 23240

- The 23240 container rinsing nozzle is used to rinse residue from containers before disposal.
- Can be used for containers with 1½" diameter openings or larger.

- Three flat spray orifices provide self-rotational forces needed to create spherical coverage.
- Available in ½" NPT or BSPT (F) connections.

### Typical Application

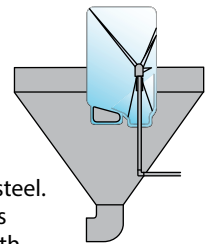

- Made of 316 stainless steel. HSS bearings and races have been replaced with 316SS bearings and races. Also includes an internal sleeve made of Nylon.

NOZZLE NUMBER	INLET PIPE CONNECTION	CAPACITY (GPM)				
		20 PSI	30 PSI	40 PSI	50 PSI	60 PSI
(B)23240-3-316SS-5.7-316SS	½" (F)	4.0	4.9	5.7	6.4	7.0
(B)23240-3-316SS-7-316SS		4.9	6.1	7.0	7.8	8.6



## VSM

- Used for inside rinsing of chemical containers.
- Fourty orifices combine to produce a 240° spray angle.

- All Nylon construction.
- Available with ½" or ¾" NPT or BSPT (F) connection.
- Recommended operating pressure 30–60 PSI.

NOZZLE NUMBER	INLET PIPE CONNECTION	ORIFICE DIAMETER	CAPACITY (GPM)						SPRAY ANGLE
			20 PSI	30 PSI	40 PSI	60 PSI	80 PSI	100 PSI	
(B) VSM-*-28	½" (F)	.031"	3.9	4.8	5.5	6.7	7.8	8.7	240°
(B) VSM-*-44		.039"	6.1	7.5	8.6	10.6	12.2	13.7	
(B) VSM-*-90		.059"	12.5	15.3	17.7	22	25	28	
(B) VSM-*-140	½" or ¾" (F)	.077"	19.4	24	27	34	39	43	
(B) VSM-*-190		.091"	26	32	37	46	53	59	

### HOW TO ORDER

( B ) V S M - 3 / 4 - 1 4 0  
 |        |        |        |  
 BSPT    Nozzle Type    Size        Capacity



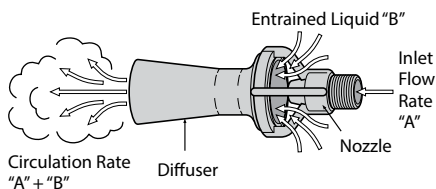

## 46550, Y33180 & Y9270

- Allows small pumps to circulate large volumes of liquid.
- Manufactured of glass-filled polypropylene for excellent corrosion and chemical resistance.
- Large flow opening minimizes plugging.
- Available in 1/4", 3/8", 3/4" or 1 1/2" (M) pipe thread inlet connection.

APPROXIMATE FLOW RATE PERFORMANCE	MODEL NUMBER	INLET LIQUID PRESSURE							
		10 PSI	15 PSI	20 PSI	25 PSI	30 PSI	35 PSI	40 PSI	50 PSI
Inlet Flow Rate "A" (GPM)	46550-1/4-PP	3.5	4.3	5.0	5.5	6.1	6.6	7.0	7.8
	Y33180-PP	9	11	12.7	14	16	17	18	20
	Y9270-PP	13.5	17	19	21	23	25	27	30
Entrained Liquid "B" (GPM)	46550-1-1/2-PP	33	40	47	53	58	63	66	75
	46550-1/4-PP	12.7	15.1	17.8	19.6	22	24	26	29
	Y33180-PP	36	44	50.8	56	64	68	72	80
Circulation Rate "A"+"B" (GPM)	Y9270-PP	54	68	76	84	92	100	108	120
	46550-1-1/2-PP	132	160	188	212	232	252	264	300
	46550-1/4-PP	16.2	19.4	22.8	25.1	28.1	30.6	33.0	36.8
Circulation Rate "A"+"B" (GPM)	Y33180-PP	45	55	63.5	70	80	85	90	100
	Y9270-PP	67.5	85	95	105	115	125	135	150
	46550-1-1/2-PP	165	200	235	265	290	315	330	375

### HOW TO ORDER

Y 3 3 1 8 0 - P P

MODEL NUMBER	PIPE THREAD INLET CONNECTION	ORIFICE DIAMETER	LENGTH	DIAMETER
46550-1/4-PP	1/4" (M)	3/16"	3"	1 1/4"
Y33180-PP	3/8" (M)	5/16"	4 1/16"	2 1/16"
Y9270-PP	3/4" (M)	3/8"	6 3/8"	2 29/32"
46550-1-1/2-PP	1 1/2" (M)	9/16"	10"	4 1/2"

# TeeJet® JET AGITATORS

Installed at bottom of spray tank on end of agitator return line. Continuous solid stream jet flow creates turbulence and keeps wettable powders in suspension.



## 6290-SC

Made in choice of brass, aluminum and all stainless steel. 1/4" NPT (F) inlet connection. Fits through 2" hole. Weight 6 oz. Siphon caps increase liquid flow by Venturi action to increase mixing potential.

### HOW TO ORDER

Brass

6 2 9 0 S C - 1

Aluminum

6 2 9 0 S C - 1 - A L

Stainless Steel

6 2 9 0 S C - 1 - S S

JET AGITATOR NUMBER	ORIFICE CAP NUMBER	ORIFICE CAP INLET DIAMETER	CAPACITY (GPM) THRU AGITATOR LINE AT VARIOUS PRESSURES						FOR MAX. TANK SIZE IN GALLONS OF:
			10 PSI	15 PSI	20 PSI	30 PSI	40 PSI	50 PSI	
6290SC-1	11118-1	.055"	.78	.96	1.1	1.4	1.6	1.8	50
6290SC-2	11118-2	.086"	1.9	2.3	2.7	3.3	3.8	4.3	110
6290SC-3	11118-3	.096"	2.4	2.9	3.3	4.1	4.7	5.3	140
6290SC-5	11118-5	.144"	4.4	5.4	6.2	7.6	8.8	9.9	250
6290SC-8	11118-8	.156"	5.1	6.3	7.2	8.8	10.2	11.4	300
6290SC-10	11118-10	.177"	5.7	7.0	8.0	9.7	11.4	12.7	350

**Note:** Maximum tank sizes shown in table are approximate and are based on 40 PSI operation with pesticides, not fertilizers.

## MATRIX® 430 GUIDANCE (BROAD ACREAGE)

The compact Matrix 430 is an easy-to-use, low-cost, graphical guidance system ideal for first-time users. The full-color, touchscreen display allows the operator to efficiently navigate fields with minimal skips and overlaps in coverage.

- Versatile GNSS guidance in a compact, portable package.
- Full time, on screen numeric display of cross-track error with user selectable display of two additional parameters including: worked area, worked time, and ground speed.
- High-quality, internal GPS/GLONASS engine with ClearPath technology that enhances GNSS performance.
- Guidance modes include: Straight AB, Curved AB, Circle Pivot, and Last Pass.
- Applied alert provides operator with audible alarm when entering previous applied areas.
- Simple reporting function provides coverage reports in .KML or .PDF.



PART NUMBER	DESCRIPTION
GD430-GLO-P-B	Kit, Matrix 430, GLONASS, Patch Antenna, Battery Leads
GD430-GLO-P-L	Kit, Matrix 430, GLONASS, Patch Antenna, US Lighter Connector
GD430-GLO-R30-B	Kit, Matrix 430, GLONASS, RXA-30 Antenna, Battery Leads
GD430-GLO-R30-L	Kit, Matrix 430, GLONASS, RXA-30 Antenna, US Lighter Connector

## MATRIX 430VF GUIDANCE (VINEYARDS/ORCHARDS)

Matrix 430VF is an easy-to-use, reliable, and cost-effective GNSS guidance system specifically designed to simplify operations in vineyards and orchards. It offers the functionality and reporting features of the original Matrix 430, but with mapping and guidance features specific to these specialized applications.

- Applied rows are colored to show where applications have occurred, and where skips or double applications have occurred.
- Alerts operator when entering an applied row or area.
- Storage for up to five jobs make record keeping easy.
- Five different machine profiles allow easy switching between machines or machine setups.
- Excellent display visibility in bright light or at night.
- Easy to understand and easy to use.



PART NUMBER	DESCRIPTION
GD430VF-GLO-P-B	Kit, Matrix 430VF, GLONASS, Patch Antenna, Battery Leads
GD430VF-GLO-P-L	Kit, Matrix 430VF, GLONASS, Patch Antenna, US Lighter Connector
GD430VF-GLO-R30-B	Kit, Matrix 430VF, GLONASS, RXA-30 Antenna, Battery Leads
GD430VF-GLO-R30-L	Kit, Matrix 430VF, GLONASS, RXA-30 Antenna, US Lighter Connector

# MATRIX 908

Matrix 908 is built for expandability, rugged performance, and easy operation in many agricultural and turf applications. As the latest in the Matrix family, the Matrix 908 offers a bright, clear display, intuitive menu structure and long-lasting construction. Choose a field navigation model for GNSS guidance and coverage mapping, including automatic boom section control. Or opt for an ISOBUS-ready model that performs guidance functions plus an ISOBUS UT for sprayer or spreader control. The high-performance, built-in GNSS receiver offers accuracy upgrade options with no change in hardware, making the Matrix 908 a great fit for a wide range of current or future applications.

- Integrated GNSS receiver offers upgradable accuracy with no changes in console or antenna hardware.
- Base version offers guidance, mapping, and automatic section control; an ISOBUS UT and task control available via convenient feature unlock.
- TwinView allows the operator to view guidance and UT screen side-by-side.
- The 8" high-resolution display can be viewed in bright daylight or set to night mode for low-light conditions.
- Rugged metal enclosure makes the Matrix 908 durable and long lasting.



MOBILE ELECTRONICS

**NAV WITH HARNESS KITS & INTERNAL RECEIVER**

PART NUMBER	DESCRIPTION
90-1006-ENUS	Kit, M908 NAV-L1-GLO-ENUS
90-1007-ENUS	Kit, M908 NAV-L2+TSL-GLO-ENUS
90-1008-ENUS	Kit, M908 NAV-L2+TSC-GLO-ENUS

**ISO WITH HARNESS KITS & INTERNAL RECEIVER**

PART NUMBER	DESCRIPTION
90-10011-ENUS	Kit, M908 ISO-L1-GLO-ENUS
90-10012-ENUS	Kit, M908 ISO-L2+TSL-GLO-ENUS
90-10013-ENUS	Kit, M908 ISO-L2+TSC-GLO-ENUS

**90-10006-ENUS KITS PARTS DIAGRAM**

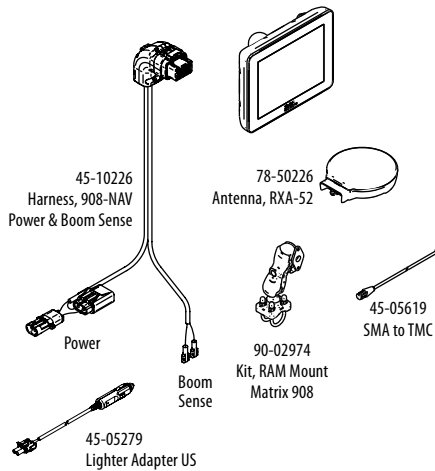

**90-10011-XX KITS PARTS DIAGRAM**

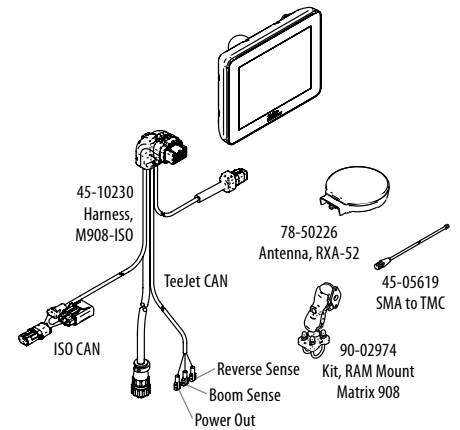

## M 9 0 8 N A V - L 1 - G L O - E N

MODEL	
908	8" Screen

CONFIGURATION	
NAV	Navigation
ISO	ISOBUS

GNSS FREQUENCY CONFIGURATION	
N	No Internal Receiver
L1	Single Frequency SBAS
L2+TSL	Dual Frequency with TERRASTAR-L
L2+TSC	Dual Frequency with TERRASTAR-C

GNSS CONSTELLATIONS	
N	No Internal Receiver
GLO	GLONASS

LANGUAGES	
EN	English Metric
EN US	English US Units
BG	Bulgarian
CZ	Czech
DA	Danish
DE	German
ES	Central & South America
ET	Estonian
FI	Finnish

## MATRIX 908 SYSTEM DIAGRAM

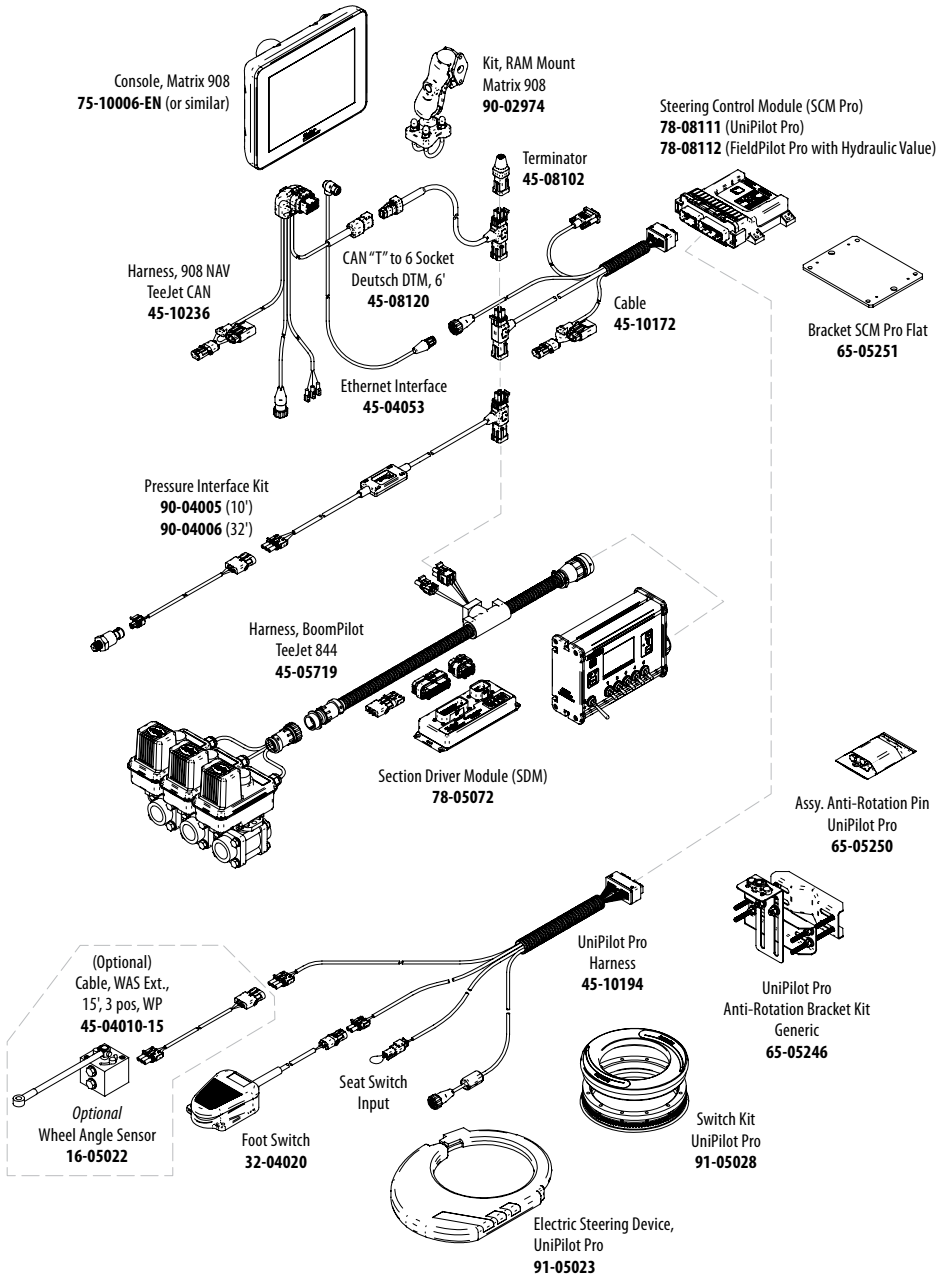

## ACCESSORIES



### UNIPILOT® PRO

- Automatic steering solution.
- Easy to install without removing steering wheel.
- Fast to transfer between different applications.
- Compatible with a broad range of machines.
- Upgradable feature for Matrix 908, 570GS, and 840GS consoles.



### BOOMPILOT® KITS

- Automatically control boom section valves according to GPS as applied mapping.
- Eliminate costly overlaps or skips that can occur from manual control.
- Compatible with sprayers and dry spreaders.
- Can control up to 15 sections.
- BoomPilot kits developed to interface with a wide variety of existing controllers.



744E-3



744A-3

## 744 MANUAL SPRAYER CONTROLS

The 744 family of sprayer controls offer simple manual control of electric boom section valves and an electric pressure regulating valve. These controls are available in a range of kits configured for connection to solenoid or ball valves. The 744 offers a backlit pressure gauge and LEDs to indicate section switch status. A convenient master switch allows all boom sections to be switched simultaneously.

- 744A kits offered with 3 section switches and a choice of 100 PSI or 300 PSI gauges.
- 744E kits offered with 100 PSI gauge and choice of 3 or 5 section switches.
- Kits include convenient harnesses to make connections fast and easy. Optional extension cables allow custom fit to many machine types.

### 3 SECTION 744 (100 PSI) BALL VALVE KITS

PART NUMBER	DESCRIPTION
90-02439-MP	Kit, 744A, 3 Boom 100 PSI, Metri-Pack Ball Valve Harness
90-02439-MD	Kit, 744A, 3 Boom 100 PSI, MINI-DIN Ball Valve Harness
90-02439-UX	Kit, 744A, 3 Boom 100 PSI, 4 POS WP Valve Harness
90-50254	Kit, 744A, 3 Boom 100 PSI, with 430 DIN Harness

### 3 SECTION 744 (100 PSI) SOLENOID KITS

PART NUMBER	DESCRIPTION
90-50149	Kit, 744A, 3 Boom 100 PSI, Solenoid Cables
90-50161	Kit, 744A, 3 Boom 100 PSI, Solenoid Cables, with 244C 3/4 Reg Valve
90-50163	Kit, 744A, 3 Boom 100 PSI, Solenoid Cables, with 244C 3/4 Reg Valve & 144A-3
90-50177	Kit, 744A, 3 Boom 100 PSI, Solenoid Cables, with 244C 3/4 Reg Valve & 144P-3

## BALL VALVE SYSTEM DIAGRAM

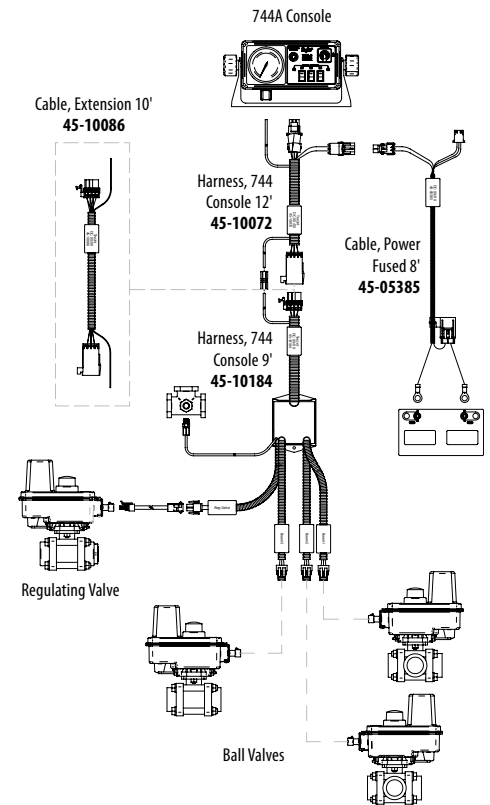

## SOLENOID VALVE SYSTEM DIAGRAM

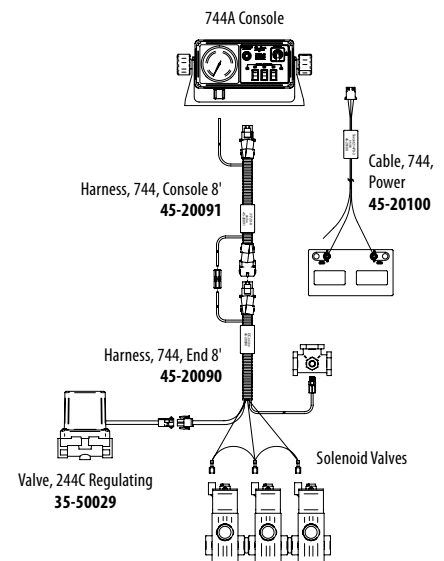



## RADION 8140 AUTOMATIC SPRAYER CONTROL

Radion is an advanced automatic spray controller that features a touch screen interface. The convenient planning tool automatically shows the available speed range for the spray tip capacity that has been selected.

- 4.3" touch-screen display is packed with useful information and can be configured to match the user's preferences.
- Tank level monitoring and automatic tank filling features are included.

- Droplet size function shows the operator approximate droplet size based on the selected nozzle and application pressure.
- Compatible with 844, 854 and 845-style wiring harness.
- Available in models to control 5, 7 or 9 boom sections.
- Performs GPS-based automatic section control when connected to a Matrix 908 field computer (feature unlock required).



PART NUMBER	DESCRIPTION
90-50259	Kit, Radion 8140-5, RAM Mount, 12' Power Cable, User Guide
90-50263	Kit, Radion 8140-7, RAM Mount, No Cables, User Guide
90-50265	Kit, Radion 8140-9, RAM Mount, No Cables, User Guide

## TEEJET 845 SPRAYER CONTROL

The TeeJet 845 was designed with simplicity in mind. The updated color display is easily visible in all light conditions and makes operation easier than ever. Key application data is always visible—including speed, application rate, volume sprayed, system pressure, and area covered. The 845 can be operated in flow or pressure-based regulation modes and offers 5 boom section control switches plus a master switch.

- Updated LCD display is backlit and easier to read than previous models.
- A single cable connection allows for easy installation and removal.
- Simple step-by-step programming is logical and easy to maneuver.
- Durable weather-resistant aluminum enclosure is durable and offers easy mounting options.
- Built-in planning tool makes spray tip selection easy.



PART NUMBER	DESCRIPTION
90-50268	Kit, 845, Mounting Bracket, 12' Power Cable, User Guide
90-50143	Kit, 845, Mounting Bracket, No Cables, User Guide

### 845 SYSTEM DIAGRAM WITH BALL VALVE CABELING

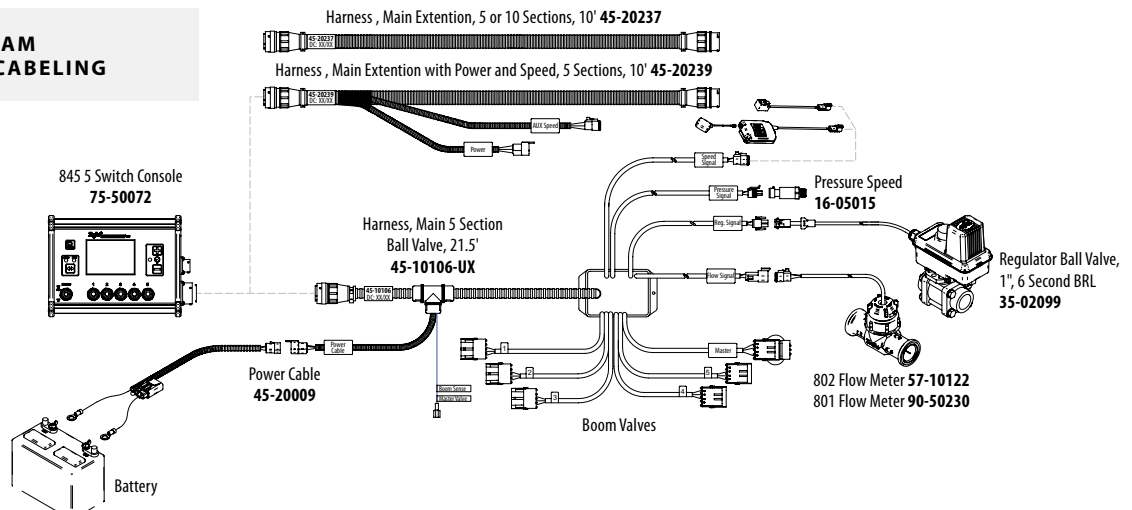



DynaJet is a nozzle control platform that extends the limits of your sprayer using PWM nozzle control. PWM stands for pulse width modulation, a technique of controlling nozzle flow rate by rapidly switching each nozzle on and off to control flow rate. Higher on time (or duty cycle) means greater flow, lower duty cycle means less flow. This control allows flow rate and pressure to be managed independently, which enables advanced application capabilities.

DynaJet alternates the on/off status of each nozzle to eliminate skips. DynaJet also performs turn compensation, applying greater rates on the outside of a turn than the inside.

- Extended speed or application rate working while maintaining pressure.
- Easily set the operating pressure from the cab, and DynaJet maintains application rate by changing nozzle duty cycle.
- 20 Hertz on/off frequency eliminates concerns about skips between spray pulses.
- Make a wide range of applications (rates, speeds and droplet sizes) with a single nozzle.
- DynaJet controls each nozzle individually, allowing swath control with high accuracy.
- Make your spray distribution uniform during turns with the Turn Compensation feature.
- On/Off control of up to 150 individual nozzles when connected to TeeJet IC45 rate control.
- Control of up to 30 sections with a third-party controller.
- Solenoid valves and cabling system tested and proven in the harshest environments, including application of liquid nitrogen fertilizer.



DynaJet ECU: DM-02

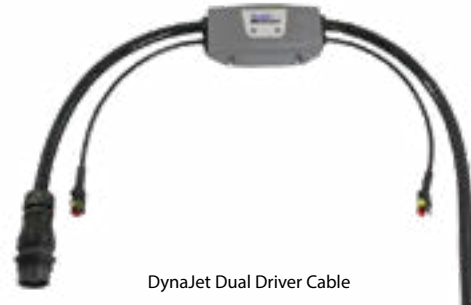

DynaJet Dual Driver Cable



## DYNAJET SYSTEM DIAGRAM

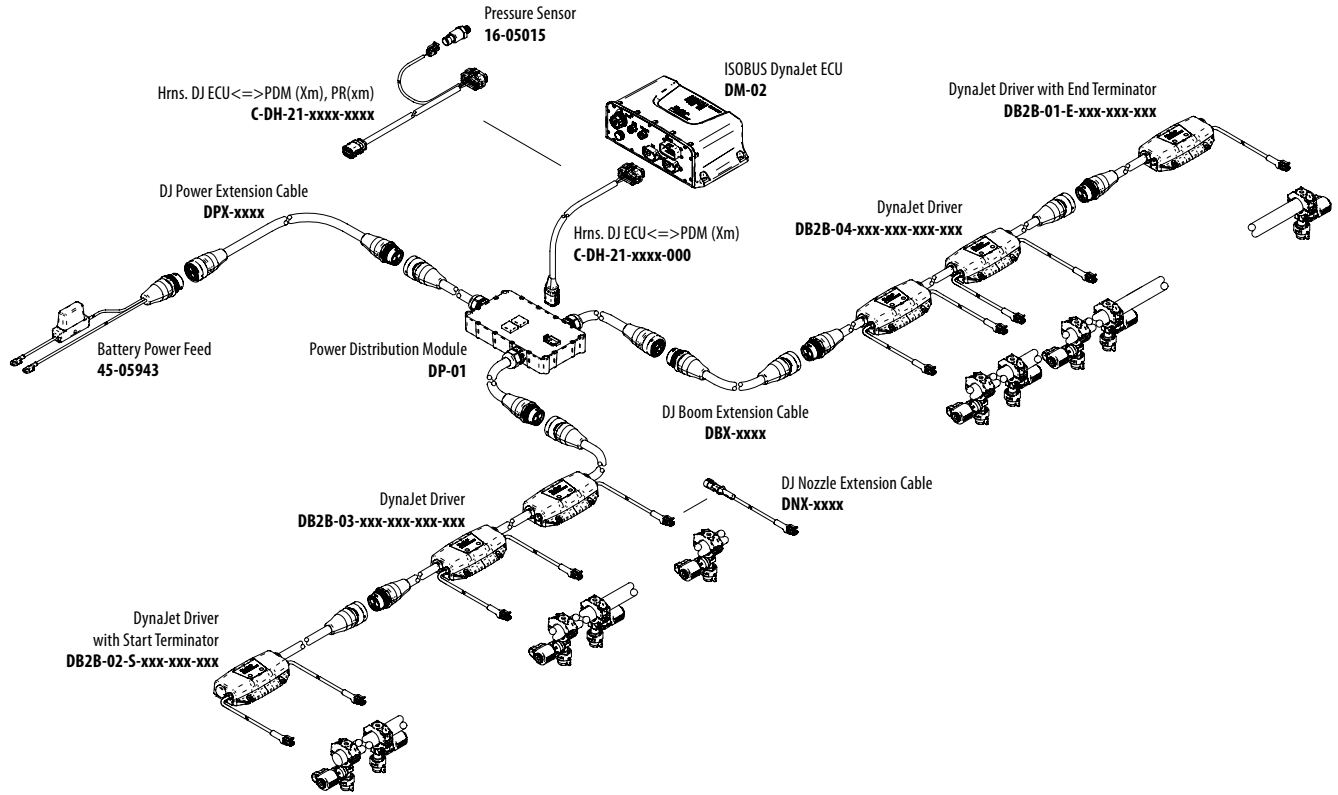

DynaJet is compatible with TeeJet solenoid valves. These nozzle valves are designed with PWM in mind. They balance power efficiency, flow capacity and durability. See page 134 for more details on TeeJet PWM nozzle solenoid valves.



115880 DynaJet Valve



116280 DynaJet High Flow Valve



Contact a sprayer manufacturer to discuss how to get DynaJet on your next sprayer.



IC45 integrates the latest in rate control features and functionality from TeeJet®. Fast and stable spray regulation is combined with modular expansion options to create a complete spray control platform.

- Updated user interface is attractive and easy to navigate.
- Modular design that allows convenient fitting on any type of sprayer.
- Section valves controlled by driver modules that control 12 valves per module. Multiple modules can be fitted, allowing control of high numbers of sections and/or other electrical functions.
- Additional modular features include tank filling with remote control station, drawbar or sprayer wheel steering for trailed sprayers, ISOBUS AUX control, with more functionality to come.
- Control for up to 30 boom section valves, or up to 150 individual nozzles when combined with DynaJet IC7140.
- Designed to operate with third party ISOBUS terminals.
- Engineered for reliability and long life.
- External status LEDs allow quick status confirmation.
- USB port for easy firmware updates.
- Multiple cable lengths to suit your needs.



IC45 ECU



IC45 Graphical Interface on Matrix 908 UT



ISOBUS Sprayer Cable



PLP 12 Output Driver





**DYNAJET & IC45 BRING ADVANCED FEATURES TO YOUR SPRAYER**

IC45 is the brand new ISOBUS Job computer. It integrates the best regulating performance and functionality from TeeJet.

DynaJet is a nozzle control platform that extends the limits of your sprayer by using PWM nozzle control.

When used together, DynaJet and IC45 become more than the sum of each component. By communicating with each other, the DynaJet and IC45 ECUs can offer advanced features, including:

- Extremely fast and stable regulating performance across a wide range of flow rates—even down to single nozzles.
- Complex manual bed application patterns with different rates by section.
- Map-driven applications that include different rates across the boom.
- Dynamic section widths depending on manual or automatic operating modes.
- Compatibility with advanced spot spraying systems.
- Easy to use on-screen virtual switch box.



DynaJet ECU



IC45 Sprayer Control

- ✓ **MORE PERFORMANCE**
- ✓ **MORE FEATURES**
- ✓ **MORE SAVINGS**

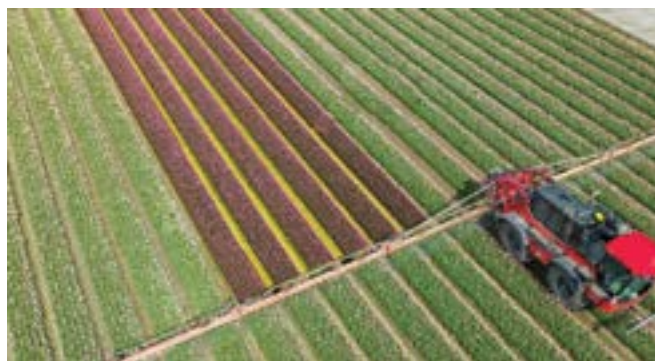

Variable Rate Application By Sections



Bed & Row Support



Spot Spraying Compatible

MOBILE ELECTRONICS





**ISOBUS SPREADER JOB COMPUTER IC38**

IC38 integrates the latest in spreader rate control features and functionality from TeeJet. A foundation of fast and stable spreader regulation is combined with other functions to create a complete spreader control platform.

- Available for Belt spreaders and drop spreaders.
- Control of up to 3 different products.
- Variable rate compatible via ISOBUS.
- Spinner speed control.
- Belt(s) speed control.
- Section control of up to 12 sections.
- Static and dynamic weighing interface.
- Designed to operate with third-party ISOBUS terminals.
- Junction-box style wiring system makes installation simple.



IC38 ECU



IC38 Graphical Interface on Matrix 908 UT



## PRESSURE SENSOR

- Available in two pressure ranges for maximum accuracy in your application.
- Reverse polarity protected.
- Weather-resistant connector.
- 145 PSI and 363 PSI.
- ¼" NPT connections.
- Sensors can withstand 2x rated pressure without damage.



Pressure Sensor

## 800 SERIES FLOW METER

- Turbine style design for optimal accuracy.
- Durable ruby-bearings for long wear life.
- Easily removed "quick check" turbine design for quick cleanup and service.
- Operating voltage of +4.5–16 VDC with LED status light.
- Wetted parts are glass-filled polypropylene, stainless steel and Viton.
- Wide range of plumbing fittings available with DirectoValve flange fittings.
- Wide range of cable connectors for compatibility to many brands of rate controllers.



801 & 802 Flow Meters

PART NUMBER	DESCRIPTION	FLOW CAPACITY*
801A	801A Flow Meter, 4 Bolt Flange, 300 PSI	2–45 GPM
801	801 Flow Meter, 50 Series Flange, 300 PSI	2–45 GPM
802	802 Flow Meter, 75 Series Flange, 200 PSI	3–130 GPM

\*14.5 PSI pressure drop at max rated flow.

## D SERIES FLOW METER

- Simple paddle wheel design for minimal flow restriction.
- Nylon construction for chemical resistance and durability.
- Sensor assembly easily removed for service.
- Pin clip-on hose barbs for easy removal from plumbing systems.
- 230 PSI pressure rating.
- Wide range of cable connectors for compatibility to many brands of rate controllers.



16D Flow Meter

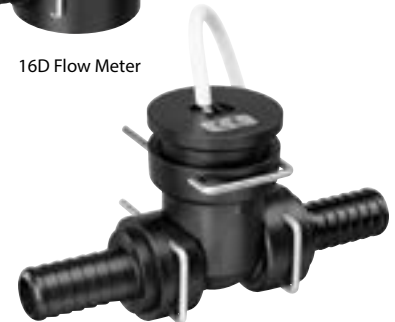

20D Flow Meter

PART NUMBER	DESCRIPTION	FLOW CAPACITY*
10D Series	10 mm Flow Meter	1.0–15 GPM
16D Series	16 mm Flow Meter	2.0–17 GPM
20D Series	20 mm Flow Meter	4.0–38 GPM
26D Series	26 mm Flow Meter	5.3–105 GPM

\*14.5 PSI pressure drop at max rated flow. Please see Technical Document 98-01111 for detailed ordering information.

## GPS SPEED SENSOR

The GPS Speed Sensor uses a GPS receiver to measure true ground speed, then delivers a frequency signal compatible with the radar speed signal input of on most controllers and monitors.

- Eliminates problems frequently found with radar speed sensors on wet surfaces, with moving crops, or vehicle vibration.
- Convenient enclosure mounts inside cab, only small patch antenna is mounted outside.
- Status LEDs show power, GPS lock, and speed output conditions.
- Wide range of adapter cables available making it compatible with all popular application rate control systems.
- Speed range 0.5–80 MPH.



GPS Speed Sensor

### COLOR CODE

1	2	3	4	5	6	7	8	9	10	11	12	13
Black	White	Red	Blue	Green	Yellow	Brown	Orange	Gray	Violet <sup>3</sup>	Lt. Blue <sup>4</sup>	Raspberry Red <sup>5</sup>	Lt. Green <sup>5</sup>

### ORDERING INFORMATION

QUICK TEEJET CAPS	PART NUMBER		FOR USE WITH FLAT SPRAY TIPS 300 PSI MAXIMUM PRESSURE
	QUICK TEEJET CAP ONLY	QUICK TEEJET CAP & SEAT GASKET SET	
	CP114440A-*CE	114441A-*CELR	<b>TeeJet® Flat Spray Tips (Smaller Capacities)</b> TP Standard -0067 to -08 XR TeeJet® -01 to -08 Turbo TwinJet® (TTJ60) AIXR TeeJet® -015 to -06
		114441A-*CELVI	
	CP25611-9-PP <sup>1</sup>	25612-9-PP <sup>1</sup>	DG TeeJet® Turbo TeeJet® (TT) -01 to -08 OC TeeJet® & TQ150 AccuPulse® TwinJet® (APTJ)
	CP25609-*NY	25610-*NYR	<b>TeeJet Flat Spray Tips (Larger Capacities)</b> TP Standard -10 to -20 XR TeeJet® -10 to -15
	CP114442A-*CE	114443A-*CELR	TJ60 TwinJet® AI TeeJet® & AIUB TeeJet® AI Turbo TwinJet® (AITTJ60) -02 to -06 Turbo TeeJet® Induction (TTI) -01 to -06 DG TwinJet® SJ3 StreamJet AIXR TeeJet® -08 to -10 TP Standard 30 to 70
		114443A-*CELVI	
	CP115834A-*CE	115835A-*CELR	Turbo TeeJet® Induction (TTI) -01 to -06
		115835A-*CELVI	
	CP114501A-*CE <sup>6</sup>	114502A-*CELR <sup>6</sup>	AI Turbo TwinJet® (AITTJ60) -08 to -15 Turbo TeeJet® Induction (TTI) -08 to -10 Turbo TeeJet® (TT) -10 to -12
		114502A-*CELVI <sup>6</sup>	
	CP98578-1-NY <sup>2</sup>	98579-1-NYR <sup>2</sup>	AI3070
	CP25595-*NY	25596-*NYR	<b>TeeJet Flat Spray Tips (Smaller Capacities)</b> Tips can be positioned in choice of two spray plane directions—parallel or perpendicular to wings of Quick TeeJet cap.
	CP25599-*NY	25600-*NYR	Turbo FloodJet® TK-VP FloodJet® TK-VS FloodJet® Locating Nib
	CP114444A-*CE	114445A-*CELR	TK FloodJet® TX/TXA ConeJet® AITXA ConeJet 4916 Flow Regulator Disc Core Seal Core
		114445A-*CELVI	
	CP25607-9-PP <sup>1</sup>	25608-9-PP <sup>1</sup>	FL FullJet® TG Full Cone Hose Shank XE TeeJet
	CP25607-*NY	—	Disc Core Seal Core Disc-Core (Insert Core into Seal) CP18999-EPR

\*Specify color code (see chart above).

<sup>1</sup> These caps only available in gray.

<sup>2</sup> These caps only available in black.

<sup>3</sup> Color available in CP114440A, CP114442A and CP114444A caps.

<sup>4</sup> Color available in CP114440A, CP114442A and CP114501A caps.

<sup>5</sup> Color available in CP114501A and CP114440A caps.

<sup>6</sup> This cap offered in Black, White, Light Green, Light Blue and Raspberry Red only.



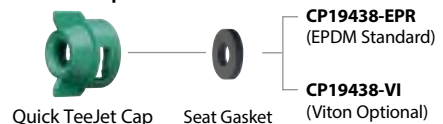





#### Quick TeeJet Cap & Seat Gasket Set

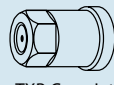
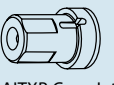

## COLOR CODE













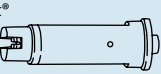









1	2	3	4	5	6	7	8	9	10	11	12	13
Black	White	Red	Blue	Green	Yellow	Brown	Orange	Gray	Violet <sup>3</sup>	Lt. Blue <sup>4</sup>	Raspberry Red <sup>5</sup>	Lt. Green <sup>5</sup>

## ORDERING INFORMATION

QUICK TEEJET CAPS	PART NUMBER		FOR USE WITH FLAT SPRAY TIPS 300 PSI MAXIMUM PRESSURE
	QUICK TEEJET CAP ONLY	QUICK TEEJET CAP & SEAT GASKET SET	
	CP26277-1-NY <sup>2</sup>	26278-1-NYR <sup>2</sup>	Ceramic Disc-Core     D-Disc Core TXB ConeJet AITXB ConeJet
	CP114395-1-NYB <sup>2</sup>	114396-1-NYR <sup>2</sup>	 114396-1-NYR includes gasket and O-Ring (CP7717-M10.5x1.5-VI). TXR ConeJet
	—	QJ4676-45-1/4-NYR <sup>2</sup>	45° Quick TeeJet cap with 1/4" NPT female threaded outlet.
	—	QJ4676-90-1/4-NYR <sup>2</sup>	90° Quick TeeJet cap with 1/4" NPT female threaded outlet.
	—	QJ4676-1/8-NYR <sup>2</sup>	Permits use of standard 1/8" and 1/4" nozzles. Can be used for mounting pressure gauge at the nozzle. (B) = BSPT
	—	QJ(B)4676-1/4-NYR <sup>2</sup>	
	—	114447A-1-CELR <sup>2</sup>	Provides shutoff at nozzle for quick spacing change or change in spray swath.
	—	114447A-1-CELVI <sup>2</sup>	

<sup>2</sup> These caps only available in black.

## CAPS FOR HARDI® NOZZLE BODIES

QUICK TEEJET CAPS	PART NUMBER		FOR USE WITH FLAT SPRAY TIPS 150 PSI MAXIMUM PRESSURE
	QUICK TEEJET CAP ONLY	QUICK TEEJET CAP & SEAT GASKET SET	
	CP21399- <sup>*</sup> -CE	21398H- <sup>*</sup> -CELR	 TJ60 TwinJet <sup>*</sup>  AI TeeJet <sup>*</sup> & AIUB TeeJet <sup>*</sup>  AI Turbo TwinJet <sup>*</sup> -02 to -06  Turbo TeeJet <sup>*</sup> Induction (TTI) -01 to -06  DG TwinJet <sup>*</sup>  S3J StreamJet  AIXR TeeJet <sup>*</sup> -08 to -10
	CP23307- <sup>*</sup> -CE	23306H- <sup>*</sup> -CELR	 TP Standard -0067 to -08  XR TeeJet -01 to -08  AIXR TeeJet <sup>*</sup> -015 to -06  DG TeeJet <sup>*</sup>  Turbo TeeJet <sup>*</sup> -01 to -08  OC TeeJet <sup>*</sup> -01 to -08  AccuPulse <sup>*</sup> TwinJet <sup>*</sup> -015 to -08
	CP58350- <sup>*</sup> -CE	58348H- <sup>*</sup> -CELR	 TK FloodJet <sup>*</sup>  FL FullJet <sup>*</sup>  TX ConeJet  TG Full Cone  Hose Shank  AITXA ConeJet

**Note:** When using TeeJet tip strainer, use CP26227 gasket in place of CP23308 gasket. See page 137 for 55240 Hardi to TeeJet adapter.

<sup>\*</sup>Specify color code (see chart above).

The QJS nozzle body utilizes a modular design that allows for highly customized solutions to best fit your sprayer and spraying application needs. Choose the boom size, inlet position, outlet arrangement and tip shutoff mechanism that works best.

- Multiple outlet, stackable nozzle body is ideal for mounted, trailed and self-propelled sprayers.
- Wet boom configuration offered with choice of bottom or side inlet in six different boom diameters (½", ¾", 1", 20 mm, 25 mm, and 28 mm); dry boom version also available in three sizes (½", ¾", 1").
- Can be equipped with any combination of TeeJet ChemSaver® tip shutoffs including pneumatic, electric, manual or spring-loaded check valve.
- Choose from one to four outlets in a variety of configurations.
- Wetted parts are nylon and FKM.
- Maximum operating pressure of up to 300 PSI depending on the ChemSaver used.
- Flow rating of up to 2.75 GPM at 5 PSI pressure drop and 4.0 GPM at 10 PSI pressure drop depending on ChemSaver used.
- See pages 134–135 for additional info on ChemSaver shutoffs.



QJS-S2-EM  
(tips and caps sold separately)



QJS-B3-MAA



QJS-S2-EM





The QJS-D turret series nozzle body utilizes a modular design that allows for highly customized solutions to best fit your sprayer and spraying application needs. Choose the boom size, inlet position, outlet arrangement and tip shutoff mechanism that works best.

- Multiple outlet, stackable nozzle body, with turret, is ideal for mounted, trailed and self-propelled sprayers.
- Wet boom configuration offered with choice of bottom or side inlet in six different boom diameters (½", ¾", 1", 20 mm, 25 mm, and 28 mm).
- Can be equipped with any combination of TeeJet ChemSaver® tip shutoffs including pneumatic, electric, manual or spring-loaded check valve.
- Choose from a variety of configurations.
- Wetted parts are nylon and FKM.
- Maximum operating pressure of up to 300 PSI depending on the ChemSaver used.
- Flow rating of up to 2.75 GPM at 5 PSI pressure drop and 4.0 GPM at 10 PSI pressure drop depending on ChemSaver used.
- See pages 134–135 for additional info on ChemSaver shutoffs.



QJS-D-1-EM-5-P



QJS-D-1-CM-3-P

### SAMPLE VALVE PART NUMBER

Q J S - D - 2 0 M M - \_ - C M - 3 \_ \_ - P \_ \_

SPLIT EYELET STYLE	
D	Standard
I	High Strength Inlet

CLAMP SIZES	
20 MM	20 mm Tubing
25 MM	25 mm Tubing
28 MM	28 mm Tubing
1/2	½" Pipe
3/4	¾" Pipe
1	1" Pipe

FLOW METER	
A	Side A
B	Side B
C	Both
BLANK	None

TOP & BOTTOM SHUTOFF TYPE	
C	Standard ChemSaver
M	Manual ChemSaver
E	12V e-ChemSaver
V	24V e-ChemSaver
A	Air ChemSaver
X	No ChemSaver

**Note:** Top shutoff controls side A and B; bottom shutoff controls bottom outlet.

**Note:** Assemblies are oriented with the split eyelet pointing forward. Side A is nearest the upper clamp, hinge pin; side B is opposite that. Position 1\* represents the outlet nearest the boom (when stacking perpendicular to the boom) or the far left (stacking parallel to the boom).

TURRET/SHUTOFF TYPE	
3	3 Outlet Turret Body
5	5 Outlet Turret Body
C	Body with 10 PSI Check Valve
M	Body with Manual ChemSaver®
E	Body with 12V e-ChemSaver®
V	Body with 24V e-ChemSaver®
A	Body with Air ChemSaver®
X	Body without ChemSaver®
P	End Cap
BLANK	None

**Note:** Position 1 represents outlet nearest boom or far left. Code 3, 5 or P can only be selected at position 1. If Code 3, 5 or P is selected, Position 2 and 3 must be blank.

**Note:** See Data Sheet DS58585-1 or Parts List PLQJS-D for more information.

# Quick TeeJet® QJS-Y SERIES STACKABLE NOZZLE BODIES

The QJS-Y split outlet nozzle body utilizes a modular design that allows for highly customized solutions to best fit your sprayer and spraying application needs. Choose the boom size, inlet position, outlet arrangement and tip shutoff mechanism that works best.

- Two outlet, modular nozzle body, with unique Y configuration is ideal for sprayers equipped with PWM spray tip control systems.
- Wet boom configuration offered with choice of bottom or side inlet in six different boom diameters (1/2", 3/4", 1", 20 mm, 25 mm, and 28 mm).
- Can be equipped with any combination of TeeJet ChemSaver® tip shutoffs including pneumatic, electric, manual or spring-loaded check valve.
- Features two outlets in a variety of configurations.
- Wetted parts are nylon and FKM.
- Maximum operating pressure of up to 300 PSI depending on the ChemSaver used.
- Flow rating of up to 2.75 GPM at 5 PSI pressure drop and 4.0 GPM at 10 PSI pressure drop depending on ChemSaver used.
- See pages 134–135 for additional info on ChemSaver shutoffs.



QJS-YN-1-SE-SX

## SAMPLE VALVE PART NUMBER

QJS-YN-20MM-SE-SM

LEFT

RIGHT

ORIENTATION	
F	Bottom Inlet with Flow Meter
H	Bottom Inlet High Strength
N	Bottom Inlet
R	Side Inlet High Strength
X	Bottom Inlet High Strength with Flow Meter

PIPE SIZE	
20 mm	20 mm Tubing
25 mm	25 mm Tubing
28 mm	28 mm Tubing
1/2	1/2" Pipe
3/4	3/4" Pipe
1	1" Pipe

OUTLETS & SHUTOFF TYPE	
C	Standard ChemSaver®
M	Manual ChemSaver
E	12V e-ChemSaver
V	24V e-ChemSaver
A	Air ChemSaver
X	No ChemSaver
P	QJS End Cap
SC	Side Body End Cap
SM	Side Body with Manual ChemSaver
SE	Side Body e-ChemSaver 12V
SV	Side Body e-ChemSaver 24V
SA	Side Body Air ChemSaver
SX	Side Body ChemSaver
BLANK	None

BOOM COMPONENTS

### QJ370

- Available with 3 or 5 spray positions for easy change of spray tips or quick boom flushing.
- Positive shutoff between each position.
- Automatic spray alignment using flat fan spray tips.
- Maximum operating pressure of 300 PSI.
- Bottom or side inlet in six different boom diameters: ½", ¾", 1", 20 mm, 25 mm, and 28 mm.
- Includes ChemSaver® diaphragm check valve for drip-free shutoff. Standard diaphragm opens at 10 PSI. See page 135 for additional 21950 ChemSaver® spring capacities.
- Standard FKM diaphragm and O-rings.
- Also available with optional Air ChemSaver® or e-ChemSaver shutoff valves, see pages 134–135 for additional information.
- QJ373 Flow Rate: 2.6 GPM at 5 PSI pressure drop; 3.6 GPM at 10 PSI pressure drop.

- QJ375 Flow Rate: 2.4 GPM at 5 PSI pressure drop; 3.4 GPM at 10 PSI pressure drop.
- Mounts to a ⅜" hole drilled in pipe or tubing (7 mm inlet option available on ½" size).
- Molded hex socket in upper clamp for attaching to flat surfaces. Accepts ⅝" or M8 bolt.
- Hinged upper clamp reduces assembly time and fits inside common boom channels.
- Notched inlet tube allows for more complete boom drainage and reduces sediment buildup.



### QJ373

PART NUMBER	NUMBER OF SPRAY OUTLETS	TO CLAMP ON
QJ373-20MM-NYB	3	20 mm Tubing
QJ373-25MM-NYB	3	25 mm Tubing
QJ373-28MM-NYB	3	28 mm Tubing
QJ373-1/2-NYB	3	½" Pipe
QJ373-1/2-6MM-NYB	3	½" Pipe
QJ373-3/4-NYB	3	¾" Pipe
QJ373-1-NYB	3	1" Pipe

**Note:** QJ370 bodies are available with the check valve on the left side (as viewed with plug facing you). Add -L after the QJ373 in the part number. Example: QJ373-L-1-NYB.



QJ373

### QJ375

PART NUMBER	NUMBER OF SPRAY OUTLETS	TO CLAMP ON
QJ375-20MM-NYB	5	20 mm Tubing
QJ375-25MM-NYB	5	25 mm Tubing
QJ375-28MM-NYB	5	28 mm Tubing
QJ375-1/2-NYB	5	½" Pipe
QJ375-1/2-6MM-NYB	5	½" Pipe
QJ375-3/4-NYB	5	¾" Pipe
QJ375-1-NYB	5	1" Pipe

**Note:** QJ370 bodies are available with the check valve on the left side (as viewed with plug facing you). Add -L after the QJ375 in the part number. Example: QJ375-L-1-NYB.



QJ375

### QJ360C SERIES

- Available with either 3, 4 or 5 spray positions for easy change of spray tips or quick boom flushing.
- Positive shutoff between each position.
- Automatic spray alignment using flat fan spray tips.
- Maximum operating pressure of 300 PSI.
- Available to fit 25 mm tubing, ½", ¾", and 1" pipe.
- Includes ChemSaver® diaphragm check valve for drip-free shutoff. Standard diaphragm opens at 10 PSI. See page 135 for additional 21950 ChemSaver spring capacities.
- Standard EPDM diaphragm with FKM available as an option.
- Also available with optional Air ChemSaver or e-ChemSaver shutoff valves, see pages 134–135 for additional information.
- Flow Rate: 2.25 GPM at 5 PSI pressure drop, 3.18 GPM with 10 PSI pressure drop.



### QJ360E SERIES

- Mounts to a ⅜" hole drilled in pipe or tubing (7 mm inlet option available on ½" size).
- Molded hex socket in upper clamp for attaching to flat surfaces. Accepts ⅝" or M8 bolt.
- Hinged upper clamp reduces assembly time and fits inside common boom channels.
- Available to fit 20 mm O.D. tubing only.
- Flow Rate: 1.5 GPM at 5 PSI pressure drop, 2.1 GPM with 10 PSI pressure drop.
- Reduced internal cavity to increase ChemSaver shut-off speed.
- Notched inlet tube allows for more complete boom drainage and reduces sediment buildup.



QJ363C  
QJ363E



QJ364C  
QJ364E



QJ365C  
QJ365E

### QJ363

PART NUMBER	NUMBER OF SPRAY OUTLETS	TO CLAMP ON
QJ363E-20MM-NYB	3	20 mm Tubing
QJ363C-25MM-NYB	3	25 mm Tubing
QJ363C-1/2-NYB	3	½" Pipe
QJ363C-1/2-6MM-NYB	3	½" Pipe
QJ363C-3/4-NYB	3	¾" Pipe
QJ363C-1-NYB	3	1" Pipe

### QJ364

PART NUMBER	NUMBER OF SPRAY OUTLETS	TO CLAMP ON
QJ364E-20MM-NYB	4	20 mm Tubing
QJ364C-25MM-NYB	4	25 mm Tubing
QJ364C-1/2-NYB	4	½" Pipe
QJ364C-1/2-6MM-NYB	4	½" Pipe
QJ364C-3/4-NYB	4	¾" Pipe
QJ364C-1-NYB	4	1" Pipe

### QJ365

PART NUMBER	NUMBER OF SPRAY OUTLETS	TO CLAMP ON
QJ365E-20MM-NYB	5	20 mm Tubing
QJ365C-25MM-NYB	5	25 mm Tubing
QJ365C-1/2-NYB	5	½" Pipe
QJ365C-1/2-6MM-NYB	5	½" Pipe
QJ365C-3/4-NYB	5	¾" Pipe
QJ365C-1-NYB	5	1" Pipe



### QJ370

- Available with 3 or 5 spray positions for easy change of spray tips or quick boom flushing.
- Positive shutoff between each spray position.
- Automatic spray alignment using flat fan spray tips.
- Maximum operating pressure of 300 PSI.
- Available in three sizes: ½", ¾", 1" single or double hose shanks.
- Includes ChemSaver® diaphragm check valve for drip-free shutoff. Standard diaphragm opens at 10 PSI. See page 135 for additional 21950 ChemSaver spring capacities.
- Standard FKM diaphragm and O-rings.
- Also available with optional Air ChemSaver or e-ChemSaver shutoff valves, see pages 134–135 for additional information.
- Durable design mounts body high on boom structure for maximum protection.
- QJ373 Flow Rate: 2.6 GPM at 5 PSI pressure drop; 3.6 GPM at 10 PSI pressure drop.
- QJ375 Flow Rate: 2.4 GPM at 5 PSI pressure drop; 3.4 GPM at 10 PSI pressure drop.
- Molded hex socket in upper clamp for attaching to flat surfaces. Accepts ⅝" or M8 bolt. Optional upper clamp for M6 bolt.



### QJ373

PART NUMBER			NUMBER OF SPRAY OUTLETS	TO FIT HOSE I.D.
SINGLE LEFT HAND	SINGLE RIGHT HAND	DOUBLE		
QJ373-500-1-NYB	QJ373-500-1R-NYB	QJ373-500-2-NYB	3	½"
QJ373-750-1-NYB	QJ373-750-1R-NYB	QJ373-750-2-NYB	3	¾"
QJ373-1000-1-NYB	QJ373-1000-1R-NYB	QJ373-1000-2-NYB	3	1"



QJ373

### QJ375

PART NUMBER			NUMBER OF SPRAY OUTLETS	TO FIT HOSE I.D.
SINGLE LEFT HAND	SINGLE RIGHT HAND	DOUBLE		
QJ375-500-1-NYB	QJ375-500-1R-NYB	QJ375-500-2-NYB	5	½"
QJ375-750-1-NYB	QJ375-750-1R-NYB	QJ375-750-2-NYB	5	¾"
QJ375-1000-1-NYB	QJ375-1000-1R-NYB	QJ375-1000-2-NYB	5	1"

**Note:** For M6 hex in upper clamp specify -6 in part number. Example: QJ375-750-2-6-NYB



QJ375

### QJ360C SERIES

- Available with either 3, 4 or 5 spray positions for easy change of spray tips or quick boom flushing.
- Positive shutoff between each spray position.
- Automatic spray alignment using flat fan spray tips.
- Maximum operating pressure of 300 PSI.
- Available to fit ½", ¾", and 1" pipe single or double hose shanks.
- Includes ChemSaver® diaphragm check valve for drip-free shutoff. Standard diaphragm opens at 10 PSI. See page 135 for additional 21950 ChemSaver spring capacities.
- Standard EPDM diaphragm with FKM available as an option.
- Also available with optional Air ChemSaver or e-ChemSaver shutoff valves, see pages 134–135 for additional information.

- Durable design mounts body high on boom structure for maximum protection.
- Flow Rate: 2.25 GPM with 5 PSI pressure drop, 3.18 GPM with 10 PSI pressure drop.
- Molded hex socket in upper clamp for attaching to flat surfaces. Accepts ⅝" or M8 bolt.
- Hinged upper clamp reduces assembly time and fits inside common boom channels.



### QJ363C

PART NUMBER		NUMBER OF SPRAY OUTLETS	TO FIT HOSE I.D.
SINGLE	DOUBLE		
QJ363C-500-1-NYB	QJ363C-500-2-NYB	3	½"
QJ363C-750-1-NYB	QJ363C-750-2-NYB	3	¾"
QJ363C-1000-1-NYB	QJ363C-1000-2-NYB	3	1"



QJ363C

### QJ364C

PART NUMBER		NUMBER OF SPRAY OUTLETS	TO FIT HOSE I.D.
SINGLE	DOUBLE		
QJ364C-500-1-NYB	QJ364C-500-2-NYB	4	½"
QJ364C-750-1-NYB	QJ364C-750-2-NYB	4	¾"
QJ364C-1000-1-NYB	QJ364C-1000-2-NYB	4	1"



QJ364C

### QJ365C

PART NUMBER		NUMBER OF SPRAY OUTLETS	TO FIT HOSE I.D.
SINGLE	DOUBLE		
QJ365C-500-1-NYB	QJ365C-500-2-NYB	5	½"
QJ365C-750-1-NYB	QJ365C-750-2-NYB	5	¾"
QJ365C-1000-1-NYB	QJ365C-1000-2-NYB	5	1"



QJ365C

## MULTIPLE NOZZLE BODIES WITH FERTILIZER OUTLETS FOR WET BOOMS

- Single fertilizer nozzle outlet with shutoff cap and either 3, 4 or 5 spray positions for easy change of spray tips or quick boom flushing.
- Positive shutoff between each position.
- Automatic self-alignment with flat fan spray patterns.
- Flow rate: 2.25 GPM with 5 PSI pressure drop through turret and 3.4 GPM through fertilizer outlet. 3.18 GPM with 10 PSI pressure drop through turret and 4.8 GPM through fertilizer outlet.
- Maximum pressure of 300 PSI.
- Available in 1" pipe connections and mounts with a 3/8" hole drilled in pipe or tubing.
- Includes ChemSaver® diaphragm check valve for drip-free shutoff. Standard diaphragm opens at 10 PSI. See page 135

for additional 21950 ChemSaver spring capacities.

- Standard O-rings and diaphragm made of EPDM and Buna with FKM optional.
- Also available with optional Air ChemSaver or e-ChemSaver shutoff valves, see pages 134–135 for additional information.
- Molded hex socket in the upper clamp for attaching to flat surfaces. Accepts 5/16" or M8 bolt.
- Hinged upper clamp reduces assembly time and fits inside common boom channels.

PART NUMBER	NUMBER OF SPRAY OUTLETS	TO CLAMP ON
QJ363F-1-NYB	3 + 1	1" Pipe
QJ364F-1-NYB	4 + 1	1" Pipe
QJ365F-1-NYB	5 + 1	1" Pipe



## MULTIPLE NOZZLE BODIES FOR WET BOOMS

### QC360 QUICK TEEJET NOZZLE BODY WITH CAM COUPLING ADAPTER

- Same features as QJ360C multiple nozzle bodies.
- Body designed to fit into standard cam lever couplings allowing for quick change to smaller capacity spray tips.
- Locating nib keeps body properly oriented in fitting.

- Flow Rate: 2.25 GPM at 5 PSI pressure drop, 3.18 GPM at 10 PSI pressure drop.
- 1.26" diameter tip body fits 3/4" cam lever coupling.

PART NUMBER	NUMBER OF SPRAY OUTLETS
QC363-NYB	3
QC364-NYB	4
QC365-NYB	5



## MULTIPLE NOZZLE BODIES WITH FERTILIZER OUTLETS FOR DRY BOOMS

- Single fertilizer nozzle outlet with shutoff cap and either 3, 4, or 5 spray positions for easy change of spray tips or quick boom flushing.
- Positive shutoff between each position.
- Automatic self-alignment with flat fan spray patterns.
- Flow rate: pressure drop of 5 PSI for 2.25 GPM through turret and 3.4 GPM through fertilizer outlet.
- Flow rate: pressure drop of 10 PSI for 3.18 GPM through turret and 4.8 GPM through fertilizer outlet.
- Maximum pressure of 300 PSI.
- Available in 1" single or double hose shanks.
- Includes ChemSaver diaphragm check valve for drip-free shutoff. Standard diaphragm

opens at 10 PSI. See page 135 for additional 21950 ChemSaver spring capacities.

- Standard O-rings and diaphragm made of EPDM and Buna with FKM optional.
- Molded hex socket in the upper clamp for attaching to flat surfaces (does not use dry boom clamp). Accepts 5/16" or M8 bolt.
- Also available with optional Air ChemSaver or e-ChemSaver® shutoff valves, see pages 134–135 for additional information.

- Hinged upper clamp reduces assembly time and fits inside common boom channels.

PART NUMBER		NUMBER OF SPRAY OUTLETS	TO FIT HOSE I.D.
SINGLE	DOUBLE		
QJ363F-1000-1-NYB	QJ363F-1000-2-NYB	3 + 1	1"
QJ364F-1000-1-NYB	QJ364F-1000-2-NYB	4 + 1	
QJ365F-1000-1-NYB	QJ365F-1000-2-NYB	5 + 1	





QJ380

### QJ380 HIGH-FLOW NOZZLE BODY

- High-capacity multiple outlet nozzle body is ideal for high speed, high volume applications including liquid fertilizer.
- Available with three spray positions for easy change of spray tips or quick boom flushing.
- Positive shutoff between each spray position.
- Automatic spray alignment when using flat fan spray tips.
- Maximum operating pressure of 150 PSI.
- Available in 3/4" or 1" pipe size.
- Requires 3/8" hole drilled in pipe or tubing.
- Includes high capacity ChemSaver® diaphragm check valve for drip-free shutoff. Diaphragm opens at 12 PSI.
- 3.0 GPM flow rate at a 5 PSI pressure drop.



- Molded hex socket in upper clamp for attaching to flat surfaces. Accepts 5/16" or M8 bolt.
- Hinged upper clamp reduces assembly time and fits inside common boom channels.
- Constructed of nylon and acetal with FKM seals and O-rings.

PART NUMBER	NUMBER OF SPRAY OUTLETS	TO CLAMP ON
QJ383-3/4-NYB	3	3/4" Pipe
QJ383-1-NYB	3	1" Pipe



QJ380F

### QJ380F HIGH-FLOW NOZZLE BODY WITH FERTILIZER OUTLET

- Same features as standard QJ380, with an additional higher flow outlet on bottom of body.
- Additional outlet can be used for very high flow applications such as liquid fertilizer.
- Flow rate through fertilizer outlet is 4.5 GPM at 5 PSI pressure drop.



PART NUMBER	NUMBER OF SPRAY OUTLETS	TO CLAMP ON
QJ383F-3/4-NYB	3 + 1	3/4" Pipe
QJ383F-1-NYB	3 + 1	1" Pipe



CP98488-VI

### CP98488-VI HI-FLOW NOZZLE BODY ADAPTER INSERT

- Reduces 1/16" wet boom inlet hole to 3/8".
- Allows QJ380 nozzle body to be used in place of non-TeeJet high-flow wet boom nozzle bodies.



QJ7421

**QJ7421-NYB**

- Can be mounted to ½", ¾" or 1" pipe or equivalent size tubing.
- ½" and ¾" sizes include a mounting hole in upper clamp subassembly for mounting to flat surfaces.
- Mounts to a ⅜" hole drilled in pipe or tubing.
- Maximum operating pressure of 300 PSI.

PART NUMBER	TO CLAMP ON	DRILL HOLE SIZE	UPPER CLAMP BOLT SIZE
QJ7421-1/2-NYB	½" Pipe	0.375"	¼"
QJ7421-3/4-NYB	¾" Pipe	0.375"	¼"
QJ7421-1-NYB	1" Pipe	0.375"	N/A



QJ17560A

**QJ17560A-NYB**

- Can be mounted to 20 mm, 25 mm, ½", ¾" or 1" pipe or equivalent size tubing.
- Features ChemSaver drip-free shutoff. Requires 10 PSI at the nozzle to open check valve.
- Standard diaphragm of EPDM with optional FKM available.
- Mounts to a ⅜" or ⅝" hole drilled in pipe or tubing.
- All sizes include a mounting hole in upper clamp subassembly for mounting to flat surfaces.
- Maximum operating pressure of 300 PSI.
- Flow rate: 2.25 GPM at 5 PSI pressure drop, 3.18 GPM at 10 PSI pressure drop.

PART NUMBER	TO CLAMP ON	DRILL HOLE SIZE	UPPER CLAMP BOLT SIZE
QJ17560A-20mm-NYB	20 mm Tubing	0.375"	⅝" or M8
QJ17560A-20mmx7-NYB	20 mm Tubing	0.280"	⅝" or M8
QJ17560A-25mm-NYB	25 mm Tubing	0.375"	⅝" or M8
QJ17560A-1/2-NYB	½" Pipe	0.375"	⅝" or M8
QJ17560A-1/2x7-NYB	½" Pipe	0.280"	⅝" or M8
QJ17560A-3/4-NYB	¾" Pipe	0.375"	⅝" or M8
QJ17560A-1-NYB	1" Pipe	0.375"	⅝" or M8



QJ22187

**QJ22187-NYB**

- Can be mounted to ½", ¾" or 1" pipe or equivalent size tubing.
- ½" and ¾" sizes include a mounting hole in clamp subassembly for mounting to flat surfaces.
- Allows side mounting to flat surface for protection of nozzle body.
- Features ChemSaver® drip-free shutoff. Requires 10 PSI at the nozzle to open check valve.
- Standard diaphragm of EPDM with optional FKM available.
- Mounts to a ⅜" hole drilled in pipe or tubing.
- Maximum operating pressure of 300 PSI.
- Flow rate: 2.5 GPM at 5 PSI pressure drop, 3.54 GPM at 10 PSI pressure drop.

PART NUMBER	TO CLAMP ON	DRILL HOLE SIZE	UPPER CLAMP BOLT SIZE
QJ22187-1/2-NYB	½" Pipe	0.375"	¼"
QJ22187-3/4-NYB	¾" Pipe	0.375"	¼"
QJ22187-1-NYB	1" Pipe	0.375"	N/A



### QJ100 SERIES

- Hose barb sizes for 3/8", 1/2" and 3/4" I.D. hose.
- Maximum operating pressure of 125 PSI.

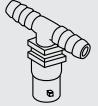
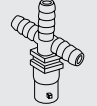
PART NUMBER SINGLE		PART NUMBER DOUBLE		PART NUMBER TRIPLE		TO FIT HOSE I.D.
	18635-111-406-NYB		18636-112-406-NYB		18637-113-406-NYB	3/8"
	18638-111-540-NYB		18639-112-540-NYB		18640-113-540-NYB	1/2"
	18719-111-785-NYB		18720-112-785-NYB		18721-113-785-NYB	3/4"



### QJ200 SERIES DIAPHRAGM CHECK VALVE

- Available with single, double or triple hose shanks for 3/8", 1/2" and 3/4" I.D. hose.
- Drip-free shutoff with TeeJet ChemSaver®. Opens at 10 PSI. Standard diaphragm is EPDM with FKM optional.
- Maximum operating pressure of 125 PSI.
- Flow rate: 2.25 GPM at 5 PSI pressure drop, 3.18 GPM at 10 PSI pressure drop.

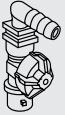
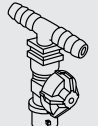
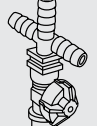
PART NUMBER SINGLE		PART NUMBER DOUBLE		PART NUMBER TRIPLE		TO FIT HOSE I.D.
	19349-211-406-NYB		19350-212-406-NYB		19351-213-406-NYB	3/8"
	19349-211-540-NYB		19350-212-540-NYB		19351-213-540-NYB	1/2"
	19349-211-785-NYB		19350-212-785-NYB		19351-213-785-NYB	3/4"



### QJ300 SERIES DIAPHRAGM CHECK VALVE

- Low-profile design allows maximum protection against damage.
- Available with single and double hose shanks for 3/8", 1/2" and 3/4" I.D. hose.
- Drip-free shutoff with TeeJet ChemSaver. Opens at 10 PSI. Standard diaphragm is EPDM with FKM optional.
- Maximum operating pressure of 300 PSI.
- Flow rate: 3.5 GPM at 5 PSI pressure drop, 4.9 GPM at 10 PSI pressure drop.
- QJ300 Series is also available in polypropylene. Maximum operating pressure is 150 PSI.

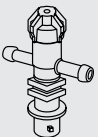
PART NUMBER SINGLE		PART NUMBER DOUBLE		TO FIT HOSE I.D.
	22251-311-375-NYB		22252-312-375-NYB	3/8"
	22251-311-500-NYB		22252-312-500-NYB	1/2"
	22251-311-750-NYB		22252-312-750-NYB	3/4"



**Note:** See page 132 for vari-spacing clamps. See page 118 for Quick TeeJet caps.

### QJ39685 SERIES

- Use with Quick TeeJet caps.
- Hose shanks available in double or single (left or right) for 1/2" hose I.D.
- TeeJet ChemSaver drip-free shutoff.
- Made of corrosion-resistant materials.
- Maximum operating pressure of 300 PSI.
- QJ39684 uses Nylon nut instead of brass nut.



Single Left  
QJ39685-1L-500-NYB



Double  
QJ39685-2-500-NYB



Single Right  
QJ39685-1R-500-NYB



# VARI-SPACING CLAMPS FOR USE ON DRY BOOM QUICK TEEJET BODIES

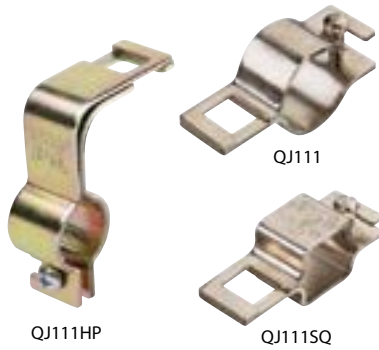

PART NUMBER (PLATED STEEL)	TO FIT
QJ111-1/2	1/2" Pipe (13/16" & 7/8" O.D. Tubings)
QJ111-3/4	3/4" Pipe (1" & 1 1/16" O.D. Tubings)
QJ111-1	1" Pipe (1 1/8", 1 1/4" & 1 3/8" O.D. Tubings)
QJ111-1-1/4	1 1/4" Pipe (1 5/8" & 1 7/8" O.D. Tubings)
QJ111HP-3/4	3/4" Pipe (1" & 1 1/16" O.D. Tubings)

PART NUMBER		TO FIT
PLATED STEEL	STAINLESS STEEL	
QJ111SQ-3/4	QJ111SQ-3/4-304SS	3/4" Square Tubing
QJ111SQ-1	QJ111SQ-1-304SS	1" Square Tubing
QJ111SQ-1-1/4	QJ111SQ-1-1/4-304SS	1 1/4" Square Tubing
QJ111SQ-1-1/2	QJ111SQ-1-1/2-304SS	1 1/2" Square Tubing



## MULTIPLE NOZZLE BODY ASSEMBLIES

### TRIPLE NOZZLE BODY

- Designed to greatly simplify changing spray tips in the field.
- Provides three spray positions for easy change of spray tips or quick boom flushing.
- Positive shutoff between each spray position.
- Includes ChemSaver® diaphragm check valve for drip-free shutoff. Opens at 10 PSI.
- Standard EPDM diaphragm with FKM available as an option.
- Can be used with all Quick TeeJet caps.
- Nylon body.
- Maximum operating pressure of 125 PSI.
- Available in 1/2" and 3/4" single, double or triple hose shanks.
- Flow Rate: 1.6 GPM at 5 PSI pressure drop, 2.26 GPM at 10 PSI pressure drop.



24230A

PART NUMBER			TO FIT HOSE
SINGLE	DOUBLE	TRIPLE	
24230A-1-540-NYB	24230A-2-540-NYB	24230A-3-540-NYB	1/2"
24230A-1-785-NYB	24230A-2-785-NYB	24230A-3-785-NYB	3/4"

### 24216A-NYB

- Can be mounted to 20 mm, 1/2", 3/4" or 1" pipe or equivalent size tubing.
- Provides three spray positions for easy change of spray tips.
- Shutoff position provided between each spray position.
- Features ChemSaver drip-free shutoff. Requires 10 PSI at the nozzle to open check valve.
- Standard diaphragm of EPDM with optional FKM available.
- Maximum operating pressure of 150 PSI (10 bar).
- 1/2" and 3/4" sizes include mounting hole in upper clamp subassembly for attachment to flat surfaces.
- Mounts to a 3/8" or 9/32" hole drilled in pipe or tubing.
- Flow rate: 1.6 GPM at 5 PSI pressure drop, 2.26 GPM at 10 PSI pressure drop.



24216A

PART NUMBER	TO CLAMP ON	DRILL HOLE SIZE	UPPER CLAMP BOLT SIZE
24216A-20MM-NYB	20 mm Tubing	0.375"	M8
24216A-20MMX7-NYB	20 mm Tubing	0.280"	M8
24216A-1/2-NYB	1/2" Pipe	0.375"	1/4"
24216A-1/2X7-NYB	1/2" Pipe	0.280"	1/4"
24216A-1/2M-NYB	1/2" Pipe	0.375"	M8
24216A-3/4-NYB	3/4" Pipe	0.375"	1/4"
24216A-1-NYB	1" Pipe	0.375"	N/A

In this type of nozzle body, the diaphragm check valve is an integral part of the nozzle assembly. This design eliminates the pressure drop associated with ball-type check valves. The spring-backed diaphragm ensures dependable closure. Originally developed for use in aerial spraying, nozzle bodies of this design are now widely used wherever drip-free shutoff is required. For maximum operating pressures of 125 PSI.

## Typical Assembly

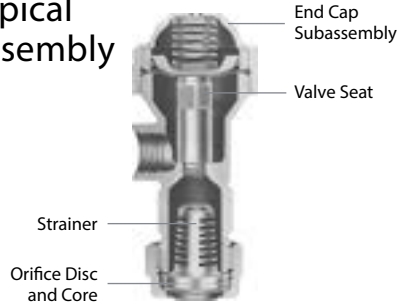

### 8355

Made of Nylon with Nylon/polypropylene end cap assembly. Check valve opens at 10 PSI pressure. Choice of 1/8" or 1/4" NPT (F) inlet connections. Flow rate for 1/8" is 3 GPM at 5 PSI pressure drop. Flow rate for 1/4" is 3.9 GPM at 5 PSI pressure drop. Overall length 2 3/4".



### 12328-NYB

Made of Nylon with acetal bonnet. Check valve opens at 7 PSI pressure. (M) inlet connection and (F) outlet connections. Choice of 1/2" and 3/4" NPT sizes. Flow rate for 1/2" is 12 GPM at 5 PSI pressure drop. Flow rate for 3/4" is 16 GPM at 5 PSI pressure drop. Overall length 3".



### 8360

Made of Nylon with Nylon/polypropylene end cap assembly. Check valve opens at 10 PSI pressure. 1/4" NPT (M) inlet connection. Flow rate of 2.25 GPM at 5 PSI pressure drop. Overall length 2".



## CHEMSAVER® DIAPHRAGM CHECK VALVE NOZZLE BODIES

Similar in design and performance to the TeeJet Diaphragm Check Valve nozzle bodies, but with pipe thread outlet connections for spray nozzles instead of TeeJet caps and spray tips. For maximum operating pressures of 125 PSI.

### 4664B

Made in choice of brass or aluminum. Check valve opens at 7 PSI pressure. 1/8" NPT (F) inlet connection. Flow rate of 2.0 GPM at 5 PSI pressure drop. Overall length 2 5/16".



### 4666B

Made of brass. 1/8" NPT (F) inlet and outlet connections. Flow rate of 2.0 GPM at 5 PSI pressure drop. Overall length 1 15/16". Check valve opens at 7 PSI pressure.



### 6140A

Made in choice of brass or aluminum. Check valve opens at 7 PSI pressure. Choice of 1/4" and 3/8" NPT (F) inlet connections. Outlet connection has dual 1/2" NPT external (M) thread and 3/8" NPT internal (F) thread. Flow rate of 4.5 GPM at 5 PSI pressure drop. Overall length 2 3/8".



### 6135A

Made in choice of brass or aluminum. Check valve opens at 7 PSI pressure. Choice of 1/4" and 3/8" NPT (F) inlet connections. Flow rate of 4.5 GPM at 5 PSI pressure drop. Overall length 2 5/8".



### (B)10742A

Made in choice of brass or aluminum. Check valve opens at 7 PSI pressure. 1/4" NPT (M) inlet and (F) outlet connections. Overall length 1 7/16". Flow rate of 2.25 GPM at 5 PSI pressure drop.



(B)=BSPT

## 115880 DYNAJET® VALVE

The 115880 e-ChemSaver® is a solenoid actuated shutoff compatible with a wide range of TeeJet nozzle bodies equipped with a diaphragm check valve. It is primarily intended for use with DynaJet or other PWM control systems.

- Valve is normally closed and opens when solenoid is energized.
- Wetted materials include stainless steel and FKM.
- Use with most diaphragm check valve equipped TeeJet nozzle bodies.
- 100 PSI maximum spraying pressure at minimum voltage (12V or 24V).
- 0.6 GPM at 5 PSI pressure drop and 0.8 GPM at 10 PSI pressure drop.
- Offered in 12-Volt or 24-Volt DC version.
- 2-Pin MetriPack connector molded into body for a clean, weather-tight electrical connection.
- Current draw of 0.9 AMPS (10 Watts) at 12-Volt DC.
- Can be ordered with power cable 98552-2 (refer to data sheet DS98552). DS98552 is valid for valves 115880, 116280, and 116950.
- Fluid feed should be filtered through a strainer with 80 mesh or finer screen.



115880

PART NUMBER	VOLTAGE (DC)	FOR USE WITH TEEJET NOZZLE BODY
115880-1-12-*	12	QJ17560A, QJ360E, QJ200, QJ300, 24216A, 24230A, QJ39685, QJP19011, QJ(T)8360, 8360, 13431, PTC Bodies
115880-1-24-*	24	
115880-2-12-*	12	QJ360C, QJ360F, QJ370, QJ22187, QJ8355, 8355
115880-2-24-*	24	
115880-4-12-*	12	QJS
115880-4-24-*	24	
115880-6-12	12	Wilger Nozzle Bodies
115880-6-24	24	
115880-7-12	12	Arag®/Hypro® Nozzle Bodies
115880-7-24	24	

\*Specify cable length in part number: 05 (0.5 m), 15 (1.5 m), 30 (3.0 m), 60 (6.0 m), 200 (20.0 m) or blank (no cable).

## 116280 DYNAJET® HF VALVE

- Designed for PWM applications requiring higher flow rates.
- Maximum rated pressure: 100 PSI (12V or 24V).
- Flow of 0.9 GPM at 5 PSI pressure drop.
- Flow of 1.3 GPM at 10 PSI pressure drop.
- Offered in 12- or 24-Volt DC version.
- Maximum current draw of 1.17 AMPS (14 Watts) at 12 Volts.
- Stainless steel/FKM wetted parts.
- Available to fit most TeeJet nozzle bodies with diaphragm check valves.
- Universal gasket to fit all Quick TeeJet bodies.
- No need for specific nozzle body valve models.



116280



116950

## 116950 E-CHEMSAVER ECOSTOP™ VALVE

- Designed for tip shutoff in individual nozzle control applications.
- Not fast enough for PWM applications.
- Maximum rated pressure: 100 PSI (12V or 24V).
- Flow of 0.7 GPM at 5 PSI pressure drop.
- Flow of 1.1 GPM at 10 PSI pressure drop.
- Offered in 12- or 24-Volt DC version.
- Maximum current draw of 0.47 AMPS (5.6 Watts) at 12 Volts.
- Stainless Steel, FKM, PEEK – interface cap, bobbin.
- Universal gasket to fit all Quick TeeJet bodies.
- No need for specific nozzle body valve models.

### HOW TO ORDER

1 1 5 8 8 0 - 1 - \* - \* \* \*

DynaJet Valve

1 1 6 2 8 0 - \* - \* \* \*

DynaJet High Flow Valve

1 1 6 9 5 0 - \* - \* \* \*

e-ChemSaver ES Valve

\* Voltage

\*\* Cable length

## TeeJet® DYNAJET® VALVE WRENCH

- Convenient multi-tool design is a must have for any sprayers equipped with e-ChemSaver tip shutoffs or DynaJet Valves.
- Also allows for Quick TeeJet cap installation and removals and orientation of various threaded nozzles and spray tips.
- Designed for easy installation, removal, and disassembly of e-ChemSaver tip shutoffs and DynaJet valves.
- Nylon construction for good strength and wear life.



CP116231-NYB

# TeeJet® NOZZLE BODY SHUTOFF VALVES

## 55300 AIR CHEMSAVER® SHUTOFF

55300 ChemSaver Air Shutoff Valve is designed as a pneumatic valve for use on Quick TeeJet® nozzle assemblies. Air pressure is used to open the valve and a spring is used to close the valve.

- Wetted materials include polypropylene, Kynar® and FKM.
- 45 PSI minimum air pressure.
- 150 PSI maximum liquid pressure.
- Air inlet fitting swivels around body and accepts 6 mm push-to-connect fittings for fast installation.
- Valve is normally closed.
- Very low air consumption per cycle reduces load on air supply system.
- 55300-1 is for use with QJS series nozzle bodies.



55300



58140

## 58140 CHEMSAVER MANUAL SHUTOFF

- Use with any application where individual shutoff is important such as golf course and estate sprayers.
- Fits any Quick TeeJet nozzle body with diaphragm check valve.
- With retaining ring in fully open position (turn counterclockwise), functions like a standard 10 PSI diaphragm check valve.
- With retaining ring in fully closed position (turn clockwise), all flow through nozzle body is shut off.
- 150 PSI maximum pressure rating.
- Nylon construction.

### HOW TO ORDER

5 5 3 0 0 or 5 5 3 0 0 - 1

Air ChemSaver Shutoff

5 8 1 4 0 - N Y B

Manual ChemSaver Shutoff

# TeeJet® NOZZLE BODY CHEMSAVER® CHECK VALVES

CHEMSAVER DIAPHRAGM CHECK VALVES	EXPLODED VIEW																	
<p>Back end of Diaphragm Check Valves (Brass)</p>	<p><b>CP6227-TEF</b> Diaphragm PTFE (optional) To be used with 4620 Diaphragm</p>	<p><b>CP4620-FA</b> Diaphragm Fairprene® or FKM</p>	<p><b>9758</b> End Cap Subassembly Brass, Aluminum</p>	<p><b>CP4624</b> Retainer Brass, Aluminum</p>														
<p>Back end of Diaphragm Check Valves (Nylon)</p>	<p><b>CP6227-TEF</b> Diaphragm PTFE (optional) To be used with 4620 Diaphragm</p>	<p><b>CP21953-EPR*</b> Diaphragm EPDM or FKM</p>	<p><b>21950-*-NYB</b> ChemSaver End Cap Assembly Nylon/ Polypropylene</p>	<table border="1"> <thead> <tr> <th>PART NUMBER</th> <th>APPROXIMATE OPENING PRESSURE</th> </tr> </thead> <tbody> <tr> <td><b>21950-2-NYB</b></td> <td>2 PSI</td> </tr> <tr> <td><b>21950-5-NYB</b></td> <td>5 PSI</td> </tr> <tr> <td><b>21950-8-NYB</b></td> <td>8 PSI</td> </tr> <tr> <td><b>21950-10-NYB</b></td> <td>10 PSI</td> </tr> <tr> <td><b>21950-15-NY</b></td> <td>15 PSI</td> </tr> <tr> <td><b>21950-20-NYB</b></td> <td>20 PSI</td> </tr> </tbody> </table>	PART NUMBER	APPROXIMATE OPENING PRESSURE	<b>21950-2-NYB</b>	2 PSI	<b>21950-5-NYB</b>	5 PSI	<b>21950-8-NYB</b>	8 PSI	<b>21950-10-NYB</b>	10 PSI	<b>21950-15-NY</b>	15 PSI	<b>21950-20-NYB</b>	20 PSI
PART NUMBER	APPROXIMATE OPENING PRESSURE																	
<b>21950-2-NYB</b>	2 PSI																	
<b>21950-5-NYB</b>	5 PSI																	
<b>21950-8-NYB</b>	8 PSI																	
<b>21950-10-NYB</b>	10 PSI																	
<b>21950-15-NY</b>	15 PSI																	
<b>21950-20-NYB</b>	20 PSI																	
<p>QJS</p>	<p><b>CP56709-VI</b> EPDM also available</p>	<p><b>56714-NYB</b> End Cap Subassembly</p>	<p><b>CP56711-NYB</b> Retaining Ring</p>															





QJ8360-NYB



QJT8360-NYB  
QJP19011-NYB

### QJT8360-NYB, QJP19011-NYB & QJ8360-NYB

- Retrofits to a Quick TeeJet system.
- Features ChemSaver® no-drip shutoff. Requires 10 PSI at the nozzle to open check valve.
- Standard diaphragm of EPDM with optional FKM available upon request.
- Maximum operating pressure of 300 PSI.
- Flow rate: 2.25 GPM at 5 PSI pressure drop, 3.18 GPM at 10 PSI pressure drop.

PART NUMBER	INLET
QJ(B)8360-NYB	¼" (M) Thread
QJT8360-NYB	1½"-16 (F) TeeJet Thread
QJP19011-NYB	¾" (F) BSPP Thread
QJ8360-1/4F-NYB	¼" (F) Thread

(B)=BSPT

### QJ8355-NYB

- Allows use of Quick TeeJet system with ⅛" and ¼" NPT female connections.
- Side mounting provides protection of the nozzle body.
- Features no-drip shutoff. Requires 10 PSI at the nozzle to open check valve.
- Standard diaphragm of EPDM with optional FKM available upon request.
- Maximum operating pressure of 300 PSI.
- Flow rate: 2.25 GPM at 5 PSI pressure drop, 3.18 GPM at 10 PSI pressure drop.



PART NUMBER	INLET
QJ8355-1/8-NYB	⅛" (F)
QJ8355-1/4-NYB	¼" (F)

### QJ1/4TT-NYB

- Allows use of Quick TeeJet system with ¼" NPT and BSPT male connections.
- Maximum operating pressure of 300 PSI.



PART NUMBER	INLET
QJ(B)1/4TT-NYB	¼" (M) Thread

(B)=BSPT

### QJ1/4T-NYB & QJT-NYB

- QJ1/4T-NYB allows use of Quick TeeJet system with ¼" NPT and BSPT female connections.
- QJT-NYB permits use of Quick TeeJet system with standard 1½"-16 TeeJet thread.
- Maximum operating pressure of 300 PSI.



PART NUMBER	INLET
(B)QJ1/4T-NYB	¼" (F) Thread
QJT-NYB	1½"-16 (F) TeeJet Thread

(B)=BSPT

### 22674-1/4-NYB

- Allows use of Quick TeeJet system with ¼" NPT or BSPT male connections.



PART NUMBER	INLET
(B) 22674-1/4-NYB	¼" (M) Thread

(B)=BSPT

## QJ90-1-NYR

- Fits standard Quick TeeJet® bodies.
- Nylon body construction for strength and durability, with EPDM gasket (FKM optional).
- Outlet can be fitted with Quick TeeJet caps and TeeJet spray tips.
- One piece, 90° elbow is ideal for installation of TK-VS FloodJet® and TF-VS or TF-VP Turbo FloodJet® nozzles on single or multiple outlet nozzle bodies. Proper orientation of spray tip enhances spray distribution quality.
- Adapter outlet accepts standard tip strainers.



## QJ90-2-NYR

- Fits standard Quick TeeJet bodies.
- Made of Nylon with CP19438-EPR gasket (included).
- Use with Quick TeeJet cap and gasket for automatic alignment when using flat fan spray tips.
- 90° included angle between outlets. When used with standard flat fan tips produces a twin type spray pattern for improved coverage and canopy penetration.



## 50854-NYB

- For use with Quick TeeJet nozzle bodies to extend body length by 1".
- Used to eliminate interference of spray pattern with sprayer boom structure or shields, particularly with twin pattern or fertilizer spray tips.
- Nylon body construction with EPDM gasket.



## 55240-CELR

- Converts Hardi® snap-fit nozzle body connection to Quick TeeJet connection for easy installation of TeeJet tips. Especially useful for AIC, XRC, SJ7A, and TT160 tips.
- Acetal construction with EPDM gasket for durability and chemical resistance.
- Accepts standard tip strainers.



## QJ-W-PP

- Converts Wilger nozzle body connection to Quick TeeJet connection.
- Polypropylene construction with Buna O-ring seal.



PART NUMBER	MAXIMUM OPERATING PRESSURE	TO FIT
QJ90-1-NYR	300 PSI	Quick TeeJet
QJ90-2-NYR	300 PSI	Quick TeeJet
50854-NYB	300 PSI	Quick TeeJet
55240-CELR	150 PSI	Hardi Snap-Fit
QJ-W-PP	150 PSI	Wilger Combo-Jet®
QJ-W-PP-10X	150 PSI	Wilger Combo-Jet (Qty. 10)

## CP116232-NY CAP INSTALLATION & REMOVAL TOOL

- Convenient multi-tool design is a must have for all sprayers.
- Designed for easy installation and removal of Quick TeeJet caps, ChemSaver® diaphragm check valves, and orientation of various threaded nozzles and spray tips.
- Reduces operator fatigue when changing out spray tips.



## CP98583 RAPID STOP NOZZLE BODY ADAPTER

- Extended inlet tube for wet boom nozzle bodies raises inlet tube height to evacuate trapped air from spray boom.
- Can significantly reduce the shut off and turn on time of spray tips for more precise application.
- Easily installed into a wide range of TeeJet wet boom nozzle bodies.
- Stainless steel construction for strength and excellent chemical resistance.

PART NUMBER	WET BOOM SIZE	FITS TEEJET NOZZLE BODY
CP98583-2-1/2-SS	½" Pipe	QJ17560A, 24216A
CP98583-2-3/4-SS	¾" Pipe	
CP98583-2-1-SS	1" Pipe	QJ360C, QJ360F, QJ370, QJ380, QJ380F, QJS
CP98583-3-1/2-SS	½" Pipe	
CP98583-3-3/4-SS	¾" Pipe	
CP98583-3-1-SS	1" Pipe	



## 23770-SS ROW APPLICATION KIT

- For applying post-emergence chemicals over crop rows.
- Arms adjustable for length and angle without removing bolts; simply loosen.
- Available with stainless steel arms.
- Positioning one arm at proper angle automatically sets correct angle of second arm.
- Fits square or round booms up to 1½" diameter.
- Kit includes standard and Quick TeeJet nozzle bodies.
- Side nozzle bodies may be rotated.
- Maximum pressure of 125 PSI.
- Spray tips and strainers not included.

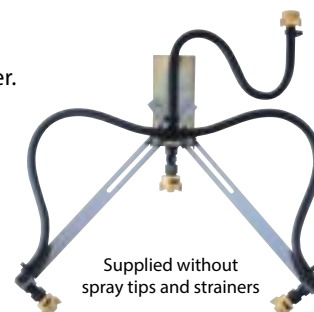

Supplied without spray tips and strainers

### STRAIGHT CAP



QJ98588  
QJ115825



QJ114398  
QJ98586

### SWIVEL CAP



QJ114404  
QJ114405



QJ114403

### 90° CAPS



QJ98598



QJ98599

### QUICK TEEJET OUTLET



QJ98590  
QJ114400



QJ98592

### BODY & CAP ASSEMBLY



QJ98594  
QJ114401



QJ98595

### PTC OUTLET BODY



QJ114430  
QJ114432  
QJ114434

- Fittings feature push to connect couplers for fast, easy, leak-free assembly.
- Offered in body, straight cap, 90° fixed cap and 90° swivel cap.
- Accepts plastic and soft metal tubing.
- Commonly used for liquid fertilizer application systems on planters and toolbars.
- Maximum operating pressure of 100 PSI.
- Caps include CP18999-EPR gasket.

### HOW TO ORDER

Q J 9 8 5 9 5 - 1 / 4 - \*

PART NUMBER	TUBING SIZE (O.D.)	DESCRIPTION
QJ98595-1/4-*	1/4"	Straight Cap & Body
QJ114401-5/16-*	5/16"	Straight Cap & Body
QJ98594-3/8-*	3/8"	Straight Cap & Body
QJ98592-1/4-*	1/4"	Body
QJ114400-5/16-*	5/16"	Body
QJ98590-3/8-*	3/8"	Body
QJ115825-3/16	3/16"	Straight Cap
QJ98588-1/4	1/4"	Straight Cap
QJ114398-5/16	5/16"	Straight Cap
QJ98586-3/8	3/8"	Straight Cap
QJ98598-90-1/4	1/4"	90° Fixed Cap
QJ98599-90-3/8	3/8"	90° Fixed Cap
QJ114403-1/4	1/4"	90° Swivel Cap
QJ114404-5/16	5/16"	90° Swivel Cap
QJ114405-3/8	3/8"	90° Swivel Cap
QJ114430-1/4-*	1/4"	Capless Body, PTC In & PTC Out
QJ114432-5/16-*	5/16"	Capless Body, PTC In & PTC Out
QJ114434-3/8-*	3/8"	Capless Body, PTC In & PTC Out

\*Specify diaphragm check valve opening pressure.

## 98450 SERIES BRASS ROLLOVER

TeeJet rollovers are designed for use on air blast sprayers in orchard and vineyard spraying applications. These compact rollovers are available with or without diaphragm check valve, offer a choice of single- or double-outlet configurations, and are available with a variety of inlet connection sizes and thread types.

Precision machined forged brass construction makes TeeJet rollovers both rugged and durable.

- Maximum recommended pressure of 750 PSI.
- Flow rate of 1.6 GPM with a 10 PSI pressure drop.
- Two shutoff positions at 90° from open.
- Three open positions at vertical and +/-15° from vertical with positive detent.
- 1/16"-16 outlet thread accepts standard tip retaining caps.

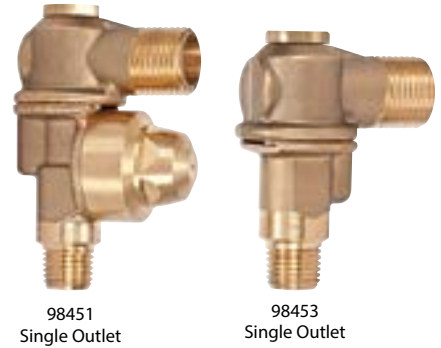

## SAMPLE ROLLOVER PART NUMBER:

B 9 8 4 5 0 - 1 / 4 F

INLET THREAD TYPE	
Blank	NPT
B	BSPT
S	NPS
P	BSPP

Note: NPS & BSPP versions include locking nut on inlet.

MODEL SPECIFICATION	
9845	Rollover

BODY CONFIGURATION	
0	Double Outlet, with Check Valve
1	Single Outlet, with Check Valve
2	Double Outlet, No Check Valve
3	Single Outlet, No Check Valve

INLET THREAD SIZE	
1/4F	1/4" Female
1/4M	1/4" Male
3/8M	3/8" Male

Note: 1/4F not available in NPS or BSPP.

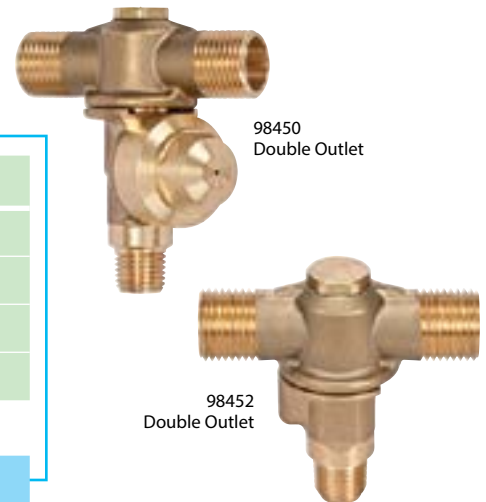

## PLUG VALVE

A compact quarter turn on-off valve for many applications. Low-profile handle is suited for use on airblast sprayers. Maximum operating pressure of 400 PSI. Brass with Celcon® handle.

PLUG VALVE NUMBER	CONNECTIONS IN NPT
(B)23220-1/4F x 1/4F	1/4" (F) x 1/4" (F)
(B)23220-1/8F x 1/8F	1/8" (F) x 1/8" (F)
(B)23220-1/4M x T	1/4" (M) x 1/16"-16 (M)
(B)23220-1/4F x T	1/4" (F) x 1/16"-16 (M)
(B)23220-1/4M x 1/4F	1/4" (M) x 1/4" (F)
(B)23220-1/4F x 1/4M	1/4" (F) x 1/4" (M)

(B)=BSPT



## TYPICAL ASSEMBLY WITH CERAMIC DISC AND CORE

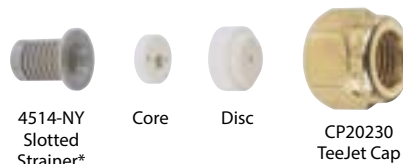

\*Use CP20229-NY gasket when 4514-NY Nylon slotted strainer is not used.

# TeeJet® SWIVEL NOZZLE BODIES

## QUICK TEEJET SWIVEL NOZZLE BODIES

QJ8600 swivel Quick TeeJet® nozzle body assemblies provide the same spray tip adjustability of a standard TeeJet® threaded swivel plus the quick change and self-aligning features of the Quick TeeJet System.

### QJ8600-2-1/4-NYB

Double Swivel Nozzle



PART NUMBER	PIPE THREAD	MATERIAL
QJ8600-2-1/4-NYB	¼" NPT (F)	Nylon

### QJ8600-1/4-NYB

Single Swivel Nozzle



PART NUMBER	PIPE THREAD	MATERIAL
QJ8600-1/4-NYB	¼" NPT (F)	Nylon

## SWIVEL NOZZLE BODIES

TeeJet swivel nozzle bodies are primarily for use with tips employed in row crop spraying. A locknut holds swivel bodies firmly in position at selected spray projection angle so they are not affected by jarring and vibration. For use at pressures up to 125 PSI.

### 5000

Single Swivel Nozzle



PART NUMBER	INLET CONNECTION	MATERIAL	SWIVEL ARC RANGE
(B)5000-1/4T	¼" NPT (F)	Brass	280°

### 5540

Single Swivel Nozzle



PART NUMBER	INLET CONNECTION	MATERIAL	SWIVEL ARC RANGE
(B)5540-1/4TT	¼" NPT (M)	Brass	280°

### 4202

Double Swivel Nozzle



PART NUMBER	INLET CONNECTION	MATERIAL	SWIVEL ARC RANGE
4202-2-1/4T	¼" NPT (F)	Brass	280°

### 6240

Double Swivel Nozzle



PART NUMBER	INLET CONNECTION	MATERIAL	SWIVEL ARC RANGE
(B)6240-1/4TT	¼" NPT (M)	Brass	280°

### 7450 COMPACT

Double Swivel Nozzle



PART NUMBER	INLET CONNECTION	MATERIAL	SWIVEL ARC RANGE
(B)7450-2T	¼" NPT (F)	Brass	280°

### 5932

Double Swivel Nozzle ¼" NPT Female Bottom Outlet



PART NUMBER	INLET CONNECTION	MATERIAL	SWIVEL ARC RANGE
5932-2-1/4T	¼" NPT (F)	Brass	280°

### 8600 NYLON

Single Swivel Nozzle



PART NUMBER	INLET CONNECTION	MATERIAL	SWIVEL ARC RANGE
8600-1/4T-NYB	¼" NPT (F)	Nylon	280°

### 8600-2 NYLON

Double Swivel Nozzle



PART NUMBER	INLET CONNECTION	MATERIAL	SWIVEL ARC RANGE
8600-2-1/4T-NYB	¼" NPT (F)	Nylon	280°

### 7620 COMPACT

Single Swivel Nozzle



PART NUMBER	INLET CONNECTION	MATERIAL	SWIVEL ARC RANGE
(B)7620-T	¼" NPT (F)	Brass	360°

## HOW TO ORDER

5 0 0 0 - 1 / 4 T (Brass NPT)

B 5 0 0 0 - 1 / 4 T (Brass BSPT)

**Note:** Swivels do not include tips, strainers or caps.

# TeeJet® HOSE DROPS

Hose drops connect to standard and Quick TeeJet nozzle bodies and can also be used with swivels. Available in 15" and 24" lengths. Maximum operating pressure of 125 PSI.

**Note:** QJ1/4T-NYB can be attached to hose drops for use with Quick TeeJet caps. See page 118 for ordering information.

ITEM	HOSE DROP NUMBER	LENGTH	INLET CONNECTION	OUTLET CONNECTION	MATERIAL
A	21353-6-15-NYB	15"	Quick TeeJet Type	¼" NPT (M)	Nylon with Quick TeeJet Cap & EPDM Gasket
	21353-6-24-NYB	24"			
B	21354-15-NYB	15"	1½"-16 TeeJet Thread		Nylon
	21354-24-NYB	24"			

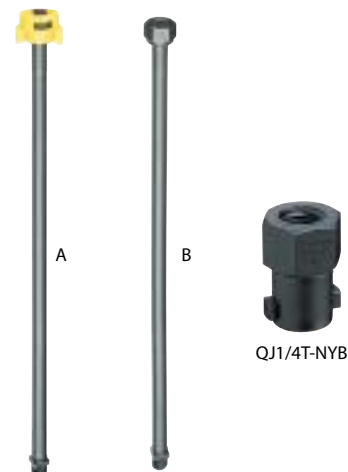



# TeeJet® HOSE SHANK NOZZLE BODIES

## FOR OPERATING PRESSURES UP TO 125 PSI

Brass, stainless steel, Nylon and acetal/ stainless steel hose shank nozzle bodies. Features 1/16"-16 TeeJet threaded outlet. See page 142 for clamp assemblies.

### SINGLE HOSE CONNECTION



HOSE SHANK BODY ASSEMBLY NUMBER	TO FIT HOSE I.D.	MATERIAL
15427-1-296	1/4"	Brass
12670-406TD-NYB	3/8"	Nylon
12670-406TD-SS	3/8"	Stainless Steel

### SINGLE HOSE CONNECTION



6471B  
8121-NYB  
9191B  
12201-CE

HOSE SHANK BODY ASSEMBLY NUMBER	TO FIT HOSE I.D.	MATERIAL
6471B-400TD	3/8"	Brass
6471-SS-C400TD	3/8"	Stainless Steel
8121-NYB-406TD	3/8"	Nylon
8121-NYB-540TD	1/2"	Nylon
9191B-531TD	1/2"	Brass
9191-SS-C531TD	1/2"	Stainless Steel
12201-CE-785TD	3/4"	Acetal Hose Shank/ Stainless Steel
12201-CE-1062TD	1"	Threaded Outlet

### DOUBLE HOSE CONNECTION



6472B  
8120-NYB  
9192B  
12202-CE

HOSE SHANK BODY ASSEMBLY NUMBER	TO FIT HOSE I.D.	MATERIAL
6472B-400TD	3/8"	Brass
6472-SS-C400TD	3/8"	Stainless Steel
8120-NYB-406TD	3/8"	Nylon
8120-NYB-540TD	1/2"	Nylon
9192B-531TD	1/2"	Brass
9192-SS-C531TD	1/2"	Stainless Steel
12202-CE-785TD	3/4"	Acetal Hose Shank/ Stainless Steel
12202-CE-1062TD	1"	Threaded Outlet

### HOW TO ORDER

1 2 2 0 2 - C E - 1 0 6 2

To order body assembly only, specify hose shank assembly number.

### TRIPLE HOSE CONNECTION



8124-NYB

HOSE SHANK BODY ASSEMBLY NUMBER	TO FIT HOSE I.D.	MATERIAL
8124-NYB-406TD	3/8"	Nylon
8124-NYB-540TD	1/2"	Nylon

# TeeJet® SPLIT EYELET NOZZLE BODIES

## FOR WET BOOMS

- Mounting on 1/2", 3/4" or 1" pipe or tubing.
- 25775-NYB mounts to 3/8" hole drilled in pipe or tubing.
- 7421 mounts to 3/32" hole drilled in pipe or tubing.
- 25775-NYB and 7421 feature 1/16"-16 TeeJet threaded outlets.
- 25888-NYB features 1/4" (M) NPT threaded outlet.



25775-NYB  
Operating pressures up to 150 PSI



7421  
Operating pressures up to 250 PSI

SPLIT EYELET ASSEMBLY NUMBER	MATERIAL	TO CLAMP ON
25775-1/2T-NYB 25888-1/2-NYB	Nylon	1/2" Pipe 13/16" O.D. Tubing 7/8" O.D. Tubing
25775-3/4T-NYB 25888-3/4-NYB	Nylon	3/4" Pipe 1" O.D. Tubing 1 1/8" O.D. Tubing
25775-1T-NYB 25888-1-NYB	Nylon	1" Pipe 1 1/4" O.D. Tubing 1 3/8" O.D. Tubing

SPLIT EYELET ASSEMBLY NUMBER	BODY MATERIAL	TO CLAMP ON
7421-1/2T	Brass	1/2" Pipe 13/16" O.D. Tubing 7/8" O.D. Tubing
7421-1/2T-SS	Stainless Steel	
7421-1/2T-NYB	Nylon	
7421-3/4T	Brass	3/4" Pipe 1" O.D. Tubing 1 1/8" O.D. Tubing
7421-3/4T-SS	Stainless Steel	
7421-3/4T-NYB	Nylon	
7421-1T	Brass	1" Pipe 1 1/4" O.D. Tubing 1 3/8" O.D. Tubing
7421-1T-SS	Stainless Steel	
7421-1T-NYB	Nylon	

### HOW TO ORDER

7 4 2 1 - 1 / 2 T - S S  
2 5 7 7 5 - 1 / 2 T - N Y B  
2 5 8 8 8 - 1 / 2 - N Y B

Specify split eyelet assembly number.

## Standard Parts

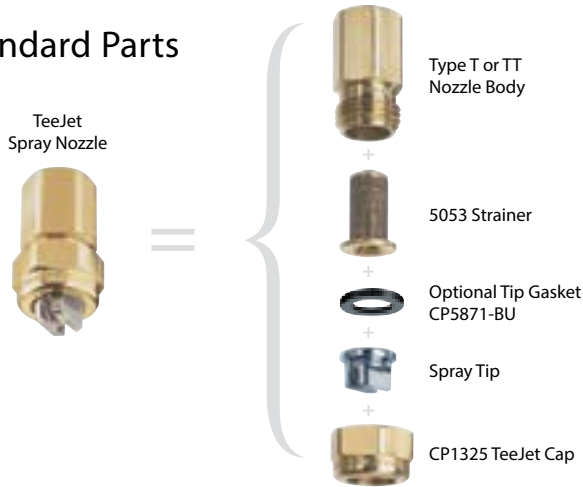

## TEEJET NOZZLE CAPS

Secure interchangeable TeeJet tips to the various nozzle bodies. 18032A-NYB winged TeeJet cap allows quick change of spray tips with no tool required.

TEEJET CAP NUMBER	DESCRIPTION
CP1325	Brass
CP8027-NYB	Nylon
CP8027-1-NYB	Nylon (Extra-Long Size)
CP1325-AL	Aluminum
CP1325-SS	Stainless Steel
CP18032A-NYB	Winged Cap, Nylon
CP3819	Brass (Use with 3/4T & 3/4TT Body)
CP3819-SS	Stainless Steel (Use with 3/4T & 3/4TT Body)
CP20230	Brass (Use with Ceramic Disc-Cores)

## 11750 TEEJET CHECK VALVE

For larger capacity TeeJet nozzles where strainers are not required. Ball check opens at 5 PSI, 10 PSI spring also available. Recommended for flow rates from 0.40–1.5 GPM. Made in choice of stainless steel, brass, aluminum or polypropylene with stainless steel ball and spring.



## TEEJET NOZZLE BODIES



**Type-TT**  
Male Inlet NPT or BSPT Connection

TEEJET BODY NUMBER	FOR TEEJET NOZZLE TYPE	MALE SIZE	MATERIAL
CP(B)1336	1/8TT	1/8"	Brass
CP(B)1322	1/4TT	1/4"	Brass
CP8028-NYB	1/4TT-NYB	1/4"	Nylon
CP(B)1322-I	1/4TT-I	1/4"	Steel
CP(B)1322-SS	1/4TT-SS	1/4"	Stainless Steel
CP(B)1324	3/8TT	3/8"	Brass
CP(B)1340	1/2TT	1/2"	Brass
CP(B)3818	3/4TT	3/4"	Brass
CP(B)3818-SS	3/4TT	3/4"	Stainless Steel

(B) = BSPT



**Type-T**  
Female Inlet NPT or BSPT Connection

TEEJET BODY NUMBER	FOR TEEJET NOZZLE TYPE	FEMALE SIZE	MATERIAL
CP(B)1335	1/8T	1/8"	Brass
CP(B)1321	1/4T	1/4"	Brass
CP(B)12094-NYB	1/4T-NYB	1/4"	Nylon
CP(B)1321-I	1/4T-I	1/4"	Steel
CP(B)1321-SS	1/4T-SS	1/4"	Stainless Steel
CP(B)1323	3/8T	3/8"	Brass
CP(B)1339	1/2T	1/2"	Brass
CP3817	3/4T	3/4"	Brass
CP3817-SS	3/4T	3/4"	Stainless Steel

(B) = BSPT

## 45° NOZZLE BODY

Ideal for use with FullJet®, FloodJet® and Turbo FloodJet nozzles. Can be used with QJ4676 Quick TeeJet® cap or standard 4676 outlet adapter. Made of polypropylene.



TEEJET BODY NUMBER	INLET	OUTLET
(B)22669-1/4-PPB	1/4" (M)	1 1/16"-16 (M)

(B) = BSPT

## HOW TO ORDER

( B ) 2 2 6 6 9 - 1 / 4 - P P B



AA111



AA111SQ

## CLAMP ASSEMBLIES

Consist of upper and lower clamps and bolt for use with hose shank nozzle bodies.

PART NUMBER	TO CLAMP ON
AA111-1/2	1/2" Pipe (1 3/16" & 7/8" O.D. Tubings)
AA111-3/4	3/4" Pipe (1" & 1 1/16" O.D. Tubings)
AA111-1	1" Pipe (1 1/8", 1 1/4" & 1 3/8" O.D. Tubings)
AA111-1-1/4	1 1/4" Pipe (1 3/8" & 1 11/16" O.D. Tubings)
AA111SQ-1	1" Square Tubing
AA111SQ-1-1/4	1 1/4" Square Tubing
AA111SQ-1-1/2	1 1/2" Square Tubing

## PIPE PLUGS



NUMBER	THREAD	MATERIAL
(B)8400-1/4-PPB	¼" NPT	Polypropylene
8400-1/2-NYB	½" NPT	Nylon
8400-3/4-NYB	¾" NPT	Nylon

(B) = BSPT

## HOW TO ORDER

8 4 0 0 - 3 / 8 - N Y B (Nylon)

Specify part number.

## PLUG TIP



CP3942 plug tip is used to temporarily shut off selected nozzles by replacing spray tips with these plug tips. Quick, easy way to change spacing of nozzles along boom. Materials: brass, aluminum, stainless steel or high-density polyethylene.

## HOW TO ORDER

C P 3 9 4 2 - H D P

Specify part number and material.

## TEEJET® HOSE SHANKS

For attaching hose to nozzle body. Fits all standard TeeJet nozzle caps, replacing spray tips. Type 4251 is available in choice of brass or stainless steel. Type 8400 is made of Nylon.



8400 4251

HOSE SHANK NUMBER	FOR HOSE I.D.	MATERIAL
8400-406-NYB	⅜"	Nylon
8400-500-NYB	½"	Nylon
4251-250	¼"	Brass
4251-250-SS	¼"	Stainless Steel
4251-312	⅝"	Brass
4251-312-SS	⅝"	Stainless Steel
4251-400	⅜"	Brass
4251-400-SS	⅜"	Stainless Steel
4251-437	⅞"	Brass
4251-437-SS	⅞"	Stainless Steel
4251-500	½"	Brass
4251-500-SS	½"	Stainless Steel

## HOW TO ORDER

4 2 5 1 - 2 5 0 (Brass)

Specify hose shank number and material.

## 4676 TEEJET OUTLET ADAPTERS



Fits the outlets of TeeJet nozzle bodies as well as the outlets of various GunJet® spray guns and shutoff valves. Replaces CP1325 TeeJet cap. Used for attaching hose drops to nozzles or extensions to spray guns.

ADAPTER NUMBER	MATERIAL OUTLET CONNECTION	NPT (F)
(B)4676-*	Brass	⅛", ¼", ⅜", ½", ¾"
4676-NYB-*	Nylon	⅛", ¼"
(B)4676-SS-*	Stainless Steel	⅛", ¼", ⅜", ½", ¾"

\*Specify outlet connection.

(B) = BSPT

## HOW TO ORDER

( B ) 4 6 7 6 - S S - 1 / 4 (Stainless Steel)

Specify adapter number and material.

## HOSE SHANK ADAPTERS



8400

CONNECTOR NUMBER	NPT THREAD CONN. (MALE)	FOR HOSE I.D.	MATERIAL
8400-1/4-300-NYB	¼"	¼"	Nylon
8400-1/4-406-NYB	¼"	⅜"	Nylon
8400-1/4-535-NYB	¼"	½"	Nylon
8400-3/8-406-NYB	⅜"	⅜"	Nylon
8400-3/8-535-NYB	⅜"	½"	Nylon
8400-1/2-406-NYB	½"	⅜"	Nylon
8400-1/2-535-NYB	½"	½"	Nylon
8400-1/2-660-NYB	½"	⅝"	Nylon
8400-3/4-535-NYB	¾"	½"	Nylon
8400-3/4-660-NYB	¾"	⅝"	Nylon
8400-3/4-785-NYB	¾"	¾"	Nylon
8400-T-406-NYB TeeJet® Body with hose shank connection	Fits TeeJet® Cap	⅜"	Nylon



13434  
13437

CONNECTOR NUMBER	NPT THREAD CONN.	FOR HOSE I.D.	MATERIAL
13434-406-NYB	¼" (F)	⅜"	Nylon
13437-540-NYB	¼" (F)	½"	Nylon

## HOW TO ORDER

6 0 5 3 - 4 0 0 (Brass)

Specify connector number and material.

## TEEJET OUTLET FITTINGS

These fittings replace spray tips and are used for attaching drop pipes to nozzle bodies or adding extensions to AA23 and AA31 GunJet spray guns and trigger valves.



CP4928

**CP4928 Adapter**—Brass or stainless steel. Length 1", ⅝" NPT female outlet connection.



CP6250

**CP6250 Adapter**—Brass or stainless steel. Length ⅝", ⅛" NPT female outlet connection.



6406

**6406 Adapter**—Brass or stainless steel. Length 1½", ⅛" NPT male outlet connection.

## HOW TO ORDER

C P 4 9 2 8 (Brass)

Specify part number and material.



6053  
6100  
10123-281

CONNECTOR NUMBER	NPT THREAD CONN. (MALE)	FOR HOSE I.D.	MATERIAL
6053-400	¼"	⅜"	Brass
6100-675	⅜"	⅝"	Brass
6100-800	¾"	¾"	Brass
10123-1/4-281	¼"	¼"	Brass



13435  
13438

CONNECTOR NUMBER	NPT THREAD CONN.	FOR HOSE I.D.	MATERIAL
13435-406-NYB	¼" (F)	⅜"	Nylon
13438-540-NYB	¼" (F)	½"	Nylon

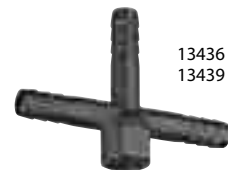

13436  
13439

CONNECTOR NUMBER	NPT THREAD CONN.	FOR HOSE I.D.	MATERIAL
13436-406-NYB	¼" (F)	⅜"	Nylon
13439-540-NYB	¼" (F)	½"	Nylon

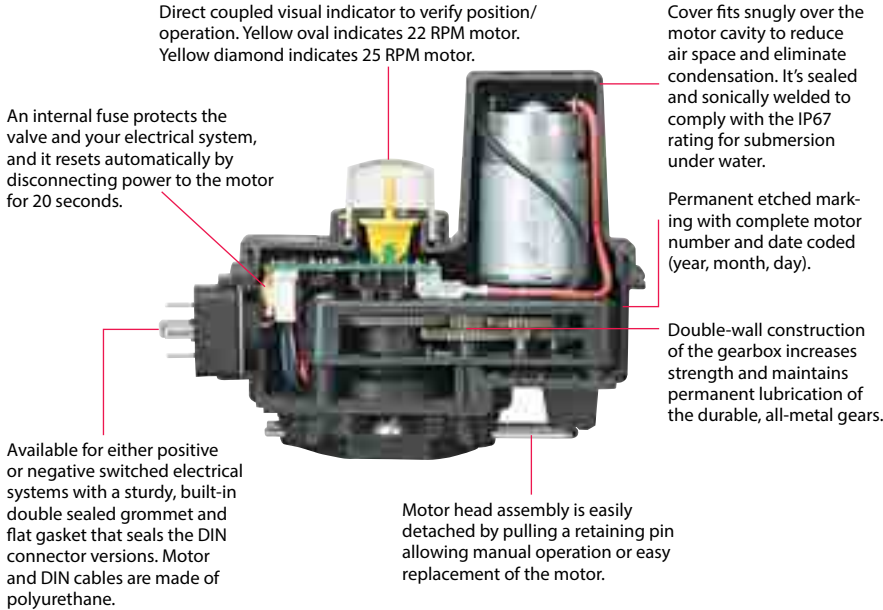

## SHUTOFF/CONTROL MOTORS

Boom Control motors are 22 RPM for 344B series (0.7 second shutoff valves) and 25 RPM for 346B and 356 series (0.6 second shutoff valves) for 12 VDC systems. Available with E or EC series motors with DIN or CABLE versions. E type motors work with DPDT (double pole, double throw) switch. EC type motors work with simple SPST (single pole, single throw) on/off switch and are compatible with all sprayer controls.

Current draw less than 2 AMPS (1.7 AMPS at 40 in-lbs.).

Electrical connectors can be ordered with a standard number. See page 157 for more information.

**Note:** 2-way control motors can be rotated 180° to change the cable outlet direction on the valve. There is also an adapter to rotate motors 90°, contact your local representative for more information.

## REGULATING MOTORS

Choosing the proper regulating motor speed is important to maximizing the sprayer's performance. Three speeds are offered at this time: 1 RPM, 3 RPM and 6 RPM. The 1 RPM speed is used mostly in manual systems; it is too slow for automated rate control. The other two speeds are used in automated systems. The 3 RPM is the most popular and opens the valve to the maximum flow in about 6 seconds for the RL valve and about 10 seconds for the PR valves. The 6 RPM motor cuts those times in half.

## DIN AND CABLE ELECTRICAL CONNECTOR

Both DIN and motor cables are made of polyurethane and are pressure extruded creating a round cable for improved sealing. Polyurethane has twice the strength and three times the tear and abrasion resistance of PVC. Motor cables include over-molded plugs that seal off the ends of cables and wires to prevent seepage. Conductor insulation uses familiar color coding of red, white and black.

DIN cable connectors are constructed of a special over molded elastomeric material that does not require a flat gasket to be sealed. The center screw is made of stainless steel.



## HOW TO ORDER

38082-30, 10' DIN cable



DIN CABLE	DIN CABLE (FT)
38082-05	1.5
38082-15	5
38082-30	10
38082-60	20

DIN cables are ordered separately.

### Positively-Switched BEC Shutoff Motors

Positively-Switched Valves are standard

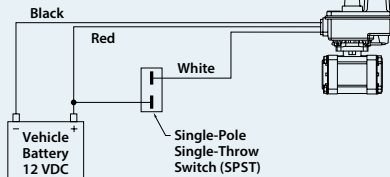

### Negatively-Switched BEC Shutoff Motors

Negatively-Switched Valves are special and are notated by an "N" in the Part Number

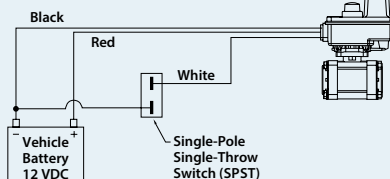

### BE Shutoff and BR Regulating Motors

Includes: BE, BR, BRL & BPR Valve Types

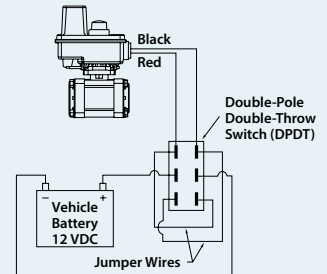

## B STYLE SHUTOFF MOTOR NUMBERS

344B, 440B, 450B, 460B SERIES			CURRENT DRAW (AMPS)**	346B, 356 AND 490 SERIES			CURRENT DRAW (AMPS)**		CABLE LENGTH
BEC POSITIVE SWITCH MOTOR	*BEC NEGATIVE SWITCH MOTOR	BE SWITCH MOTOR		344B, 440B, 450B, 460B	BEC POSITIVE SWITCH MOTOR	*BEC NEGATIVE SWITCH MOTOR	BE SWITCH MOTOR	346B	
50515-22P	50515-22N	50533-22	1.1	50515-25P	50515-25N	50533-25	1.75	2.2	No Cable, Metri-Pack Connector
50515-22CP05	50515-22CN05*	50533-22C05	1.1	50515-25CP05	50515-25CN05*	50533-25C05	1.75	2.2	1.5' Cable
50515-22CP15	50515-22CN15*	50533-22C15*	1.1	50515-25CP15	50515-25CN15*	50533-25C15*	1.75	2.2	5' Cable
50515-22CP60	50515-22CN60*	50533-22C60*	1.1	50515-25CP60	50515-25CN60*	50533-25C60*	1.75	2.2	20' Cable
50515-22DP	50515-22DN*	50533-22D*	1.1	50515-25DP	50515-25DN*	50533-25D*	1.75	2.2	DIN Electrical Connector
50515-22QP	50515-22QN*	50533-22Q*	1.1	50515-25QP	50515-25QN*	50533-25Q*	1.75	2.2	Deutsch Electrical Connector

Items marked with "\*" are non-stock items. \*\* Current draw is a nominal rating @ 13.8 VDC and will vary dependent upon valve usage and chemicals used.

**Note:** DIN cables are ordered separately.

## \*BYPASS VALVE (NORMALLY OPEN) BEC MOTORS

344B, 440B, 450B, 460B SERIES			CURRENT DRAW (AMPS)**	346B, 356 AND 490 SERIES			CURRENT DRAW (AMPS)**		CABLE LENGTH
BEC POSITIVE SWITCH MOTOR	*BEC NEGATIVE SWITCH MOTOR	BE SWITCH MOTOR		344B, 440B, 450B, 460B	BEC POSITIVE SWITCH MOTOR	*BEC NEGATIVE SWITCH MOTOR	BE SWITCH MOTOR	346B	
50994-22P	50994-22N	50533-22	1.1	50994-25P	50994-25N	50533-25	1.75	2.2	No Cable, Metri-Pack Connector
50994-22CP05	50994-22CN05*	50533-22C05	1.1	50994-25CP05	50994-25CN05*	50533-25C05	1.75	2.2	1.5' Cable
50994-22CP15	50994-22CN15*	50533-22C15*	1.1	50994-25CP15	50994-25CN15*	50533-25C15*	1.75	2.2	5' Cable
50994-22CP60	50994-22CN60*	50533-22C60*	1.1	50994-25CP60	50994-25CN60*	50533-25C60*	1.75	2.2	20' Cable
50994-22DP	50994-22DN*	50533-22D*	1.1	50994-25DP	50994-25DN*	50533-25D*	1.75	2.2	DIN Electrical Connector
50994-22QP	50994-22QN*	50533-22Q*	1.1	50994-25QP	50994-25QN*	50533-25Q*	1.75	2.2	Deutsch Electrical Connector

Items marked with "\*" are non-stock items. \*\* Current draw is a nominal rating @ 13.8 VDC and will vary dependent upon valve usage and chemicals used.

**Note:** DIN cables are ordered separately.

## 344B & 346B REGULATING MOTORS

SPEED (RPM)	R & RL MOTOR NO.	PR MOTOR NO.	CURRENT DRAW (AMPS)**		CABLE LENGTH
			AA344B	AA346B	
1	50516-01*	50996-01*	0.10	0.12	No Cable, Metri-Pack Connector
1	50516-01C05*	50996-01C05*	0.10	0.12	1.5' Cable
1	50516-01C15*	50996-01C15*	0.10	0.12	5' Cable
1	50516-01C60*	50996-01C60*	0.10	0.12	20' Cable
1	50516-01D*	50996-01D*	0.10	0.12	DIN Electrical Connector
1	50516-01Q*	50996-01Q*	0.10	0.12	Deutsch Electrical Connector
3	50516-03*	50996-03*	0.15	0.20	No Cable, Metri-Pack Connector
3	50516-03C05*	50996-03C05*	0.15	0.20	1.5' Cable
3	50516-03C15*	50996-03C15*	0.15	0.20	5' Cable
3	50516-03C60*	50996-03C60*	0.15	0.20	20' Cable
3	50516-03D*	50996-03D*	0.15	0.20	DIN Electrical Connector
3	50516-03Q*	50996-03Q*	0.15	0.20	Deutsch Electrical Connector
6	50516-06*	50996-06*	0.43	0.50	No Cable, Metri-Pack Connector
6	50516-06C05*	50996-06C05*	0.43	0.50	1.5' Cable
6	50516-06C15*	50996-06C15*	0.43	0.50	5' Cable
6	50516-06C60*	50996-06C60*	0.43	0.50	20' Cable
6	50516-06D*	50996-06D*	0.43	0.50	DIN Electrical Connector
6	50516-06Q*	50996-06Q*	0.43	0.50	Deutsch Electrical Connector

Items marked with "\*" are non-stock items. \*\* Current draw is a nominal rating @ 13.8 VDC and will vary dependent upon valve usage and chemicals used.

**Note:** DIN cables are ordered separately. See page 144 for DIN cable options.



## DIRECTOVALVE ELECTRIC PRESSURE REGULATING VALVES

The proper regulating valve will enhance the operation of a sprayer, especially one with an automatic rate controller. While advanced electronics provide features and control, the proper regulating valve helps the system to respond quickly to input changes and functions over a wide range of application rates. Choosing the proper valve involves determining the maximum capacity required, the range of application rates and the proper motor speed.

### SYSTEM CAPACITY

A regulating valve's system requirements will depend on the application amount and the pumping capacity. Additionally, the regulating valve can be used in bypass or throttling mode. In throttling mode, the flow through the valve will be applied through the nozzles. In bypass mode, the excess flow from the pump is recirculated. A valve that works well throughout the flow spectrum has the best chance to work in all situations.

### TYPES OF REGULATING VALVES

Special ball shapes make regulating valves more responsive and able to work with both high and low application rates. Most agricultural sprayers use either a 2-way ball valve or butterfly valve for regulating purposes. When considering sizing a regulating valve, the first concern is to understand the valve's flow curve to determine how efficiently the valve will regulate. Figure 1 shows typical flow curves for DirectoValve® regulating type valves. This will help to decide the type of valve to use.

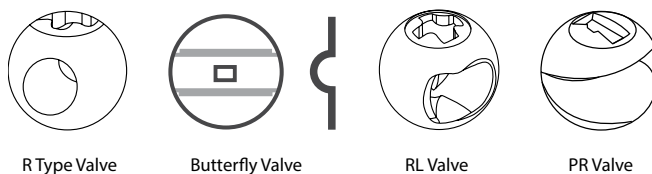

### REGULATING VALVE FLOW CURVES

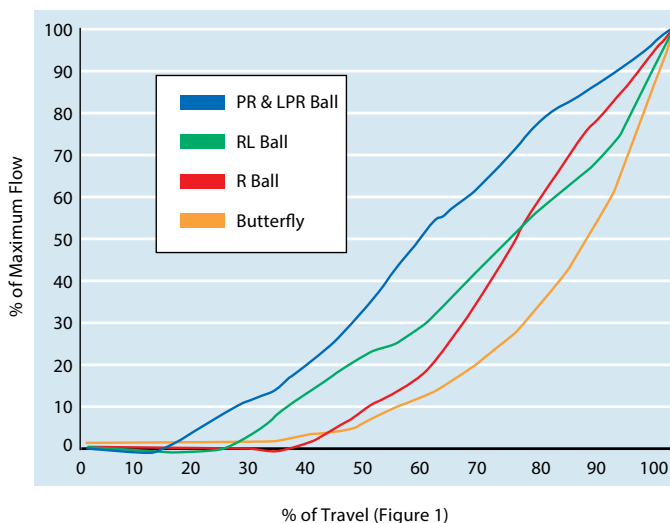

### R TYPE & BUTTERFLY VALVES

As shown on the graph, the butterfly valve has the most non-linear flow curve for final 1/3 (30°) of travel leading to an increase of 75% in flow through the valve. The straight 2-way "R" ball curve is not quite as steep, with the flow through the valve increasing by 60% over the last 30° of travel. The "R" ball, however, has the additional disadvantage of not allowing significant flow during the first 1/3 of its rotation. Since a small change of rotation causes a significant change using these valves, trying to regulate large flows when the valve is two thirds to full open presents a challenge.

### RL VALVE

TeeJet Technologies has developed a special ball that allows the valve to start regulating earlier thus extending the regulating range. This special ball valve also increases flow and the linear characteristic of the valve during the first 3/4 of the valve cycle. The flow from the valve starts 10° earlier, than a regular R type ball and increases the flow of the RL ball during the first 70% of travel (Figure 1). The maximum capacity is about 10% less than an R type valve.

### PR VALVE

The PR valve uses a 3-way valve body and a ball with a wedge removed. The combination of this ball and a motor that rotates past the standard 90° results in a valve with an almost linear flow curve. The BPR version has one outlet plugged. The 3PR version allows bypass flow to return to the tank.

As noted in Figure 1, the percentage of flow increases by approximately the amount of ball travel thus avoiding the rapid change seen with standard ball valves and butterfly valves.

### LPR VALVE

The LPR valve is similar to the PR, but with a much smaller wedge removed for very precise regulation in low flow applications.

### BALL TYPE REGULATING VALVES

MODEL NUMBER	MAXIMUM PRESSURE	FLOW RATE AT A 5 PSI PRESSURE DROP	FLOW RATE AT A 10 PSI PRESSURE DROP
344BR-2	300 PSI	32 GPM	45 GPM
344BR-3	300 PSI	24 GPM	34 GPM
344BRL-2	300 PSI	27 GPM	38 GPM
344BPR-2*	300 PSI	12 GPM	17 GPM
344BPR-3*	300 PSI	12 GPM	17 GPM
344BLPR-2*	300 PSI	1.5 GPM	2.1 GPM
344BLPR-3*	300 PSI	1.5 GPM	2.1 GPM
346BR-2	150 PSI	100 GPM	141 GPM
346BR-3	150 PSI	64 GPM	91 GPM
346BPR-2*	150 PSI	53 GPM	75 GPM
346BPR-3*	150 PSI	53 GPM	75 GPM

\* Not available in stainless steel.



344 BPR Series



346 R Series



346 BPR Series

# (B)344BRL-2FS-01C15AB

OUTLET THREADS	
BLANK	All Threads to be NPT (If Equipped)
(B)	All Threads to be BSPT (If Equipped)

MODEL SPECIFICATIONS	
344B/ 346B	Regulating Valve
364B/ 366B	Regulating Valve with Mounting Foot

MOTOR SPECIFICATIONS	
R	Regulating Valve
RL	Linear Regulating Valve (344 Series Only)
PR*	Pressure Regulating Valve
LPR**	Low-Flow PR Valve

\*Not available in stainless steel.  
\*\*Available only in stainless steel.

VALVE TYPE	
2	2-Way Valve
3	3-Way Valve (LPR, PR & R Only)

END CAPS OR OUTLET FITTINGS	
3	¾" Pipe Thread (344B/364B Only)
4	1" Pipe Thread (344B/364B Only)
5	1¼" Pipe Thread (346B/366B Only)
6	1½" Pipe Thread (346B/366B Only)
Q	Quick Connect (344B/364B Only)
F	50 Series Flange
F75	75 Series Flange (346B/366B Only)
LQ	Large Quick Connect (364B/366B Only)

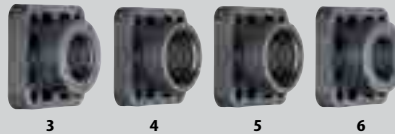

MOTOR SPEEDS	
01	1 RPM (18 Second Cycle Time) Motor
03	3 RPM (6 Second Cycle Time) Motor
06	6 RPM (3 Second Cycle Time) Motor

Note: PR/LPR series cycle times are doubled.

BALL MATERIAL SPECIFICATIONS	
BLANK	Polypropylene Ball
S	Stainless Steel Ball (R, LPR & RL Series Only)

MOTOR CABLES	
BLANK	Metri-Pack Connector
C	0.5-Meter Cable
C03*	0.3-Meter Cable
C15*	1.5-Meter Cable
C60*	6.0-Meter Cable
D	DIN Connector
Q	Positively Switched with Deutsch Connector

Items marked with "\*" are non-stock items. Contact your regional sales office for ordering and availability information.

Note: DIN cables must be ordered separately. See page 144 for DIN cables.

INLET/OUTLET REQUIRED CONNECTIONS (THE INLET/OUTLET FITTINGS ARE ORDERED SEPARATELY)	
• 3, 4, 5, 6:	When ordering ¾" (3), 1" (4), 1¼" (5) or 1½" (6) threaded NPT or BSPT inlet/outlet type valve connections, the inlets and outlets will be included during assembly.
• F:	When ordering F or F75 (flange) type valve connections, the inlet/outlet fittings are ordered separately. Clamps and flange fittings are required. See page 158 for flange fitting options.
• Q:	When ordering QC (Quick Connect) hose barb type valve fittings, the inlet/outlet connections are ordered separately. Two 45529 QC fittings are required for 2-way valves and three each for 3-way valves. See page 159 for QC options.
<b>Note:</b> Many valve configurations are possible by mixing and matching flange fittings.	

WIRING CONNECTORS	
Specify electrical connector style and pin-outs. If no connector is needed leave blank. See page 157 for electrical connectors and codes.	

REPAIR KITS	
AB344AE-KIT	AB346B-KIT

Note: AB344AE-KIT for 344A&B Valves

VALVES & MANIFOLDS

# DirectoValve® 300 SERIES



344BEC-24-P  
2-Way Valve



344BEC-34-P  
3-Way Valve



356BEC-D  
Valve

REGULATING VALVES	MOTOR SPEED (RPM)	INLET/OUTLET	FLOW RATE (GPM)*		MAX. PRESSURE (PSI)
344B, 2-Way	1, 3, or 6	¾" or 1", 50 Series Flange, QC	32 (R Valve)	27 (RL)	300
			12 (PR)	1.5 (LPR)	
344B, 3-Way	1, 3, or 6	¾" or 1", 50 Series Flange, QC	32 (R Valve)	27 (RL)	300
			12 (PR)	1.5 (LPR)	
346B, 2-Way	1, 3, or 6	1½", or 1¼", 50 Series Flange, 75 Series Flange	100		150
346B, 3-Way	1, 3, or 6	1½", or 1¼", 50 Series Flange, 75 Series Flange	64		150
SHUT OFF VALVES	MOTOR SPEED (RPM)	INLET/OUTLET	FLOW RATE (GPM)*		MAX. PRESSURE (PSI)
344B, 2-Way	22	¾" or 1", QC, 50 Series Flange	32		300
344B, 3-Way	22	¾" or 1", QC, 50 Series Flange	24		300
346B, 2-Way	25	1¼" or 1½", 50 Series Flange, 75 Series Flange	100		150
346B, 3-Way	25	1¼" or 1½", 50 Series Flange, 75 Series Flange	64		150
356B, 2-Way	25	50 Series Flange	100		150

**Note:** Flow rates are given for a single valve @ 5 PSI pressure drop and will vary based on the number of valves and inlet sizes.



# (B)344BEC-2FS-C15AB

OUTLET THREADS	
BLANK	All Threads to be NPT (If Equipped)
(B)	All Threads to be BSPT (If Equipped)

MODEL SPECIFICATIONS	
344B/ 346B	Shutoff Valve
356B	Shutoff Valve with Mounting Foot

MOTOR SPECIFICATIONS		
E	DPDT	22 RPM, 0.7 SEC Cycle (for 344B/364B)
EC	SPST	25 RPM, 0.6 SEC Cycle (for 346B/366B)

VALVE TYPE	
2	2-Way Valve
3	3-Way Valve

END CAPS OR OUTLET FITTINGS	
3	¾" Pipe Thread (344B/364B Only)
4	1" Pipe Thread (344B/364B Only)
5	1¼" Pipe Thread (346B/366B Only)
6	1½" Pipe Thread (346B/366B Only)
Q	Quick Connect (344B/364B Only)
F	50 Series Flange
F75	75 Series Flange (346B/366B Only)
LQ	Large Quick Connect (364B/366B Only)

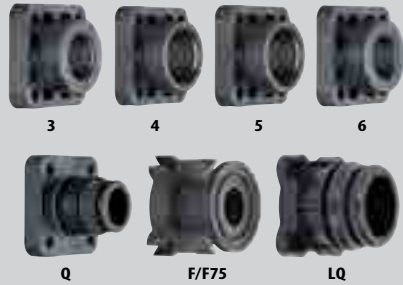

BALL MATERIAL SPECIFICATIONS	
BLANK	Polypropylene Ball
S	Stainless Steel Ball

MOTOR CABLES	
C	Positively Switched with 0.5-m Cable
C03*	Positively Switched with 0.3-m Cable
C15*	Positively Switched with 1.5-m Cable
C60*	Positively Switched with 6.0-m Cable
D	Positively Switched with DIN Connector
P	Positively Switched with Metri-Pack Connector
Q	Positively Switched with Deutsch Connector

Items marked with "\*" are non-stock items. Contact your regional sales office for ordering and availability information. CN (Negatively Switched) motors also available upon request. **Note:** DIN cables must be ordered separately. See page 144 for DIN cables.

INLET/OUTLET REQUIRED CONNECTIONS (THE INLET/OUTLET FITTINGS ARE ORDERED SEPARATELY)	
•	<b>3, 4:</b> When ordering ¾" (3) or 1" (4) threaded NPT or BSPT inlet/outlet type valve connections, the inlets and outlets will be completed during the ordering process.
•	<b>F:</b> When ordering F (flange) type valve connections, the inlet/outlet fittings are ordered separately. Two 50 series clamps and flange fittings are required for 2-way valves and three each for 3-way valves. See page 158 for flange fitting options.
•	<b>Q:</b> When ordering QC (Quick Connect) hose barb type valve fittings, the inlet/outlet connections are ordered separately. Two 45529 QC fittings are required for 2-way valves and three each for 3-way valves. See page 159 for QC options.
<b>Note:</b> Many valve configurations are possible by mixing and matching flange fittings.	

WIRING CONNECTORS	
Specify electrical connector style and pin-outs. If no connector is needed leave blank. See page 157 for electrical connectors and codes.	

REPAIR KITS	
AB344AE-KIT for 344A&B Valves AB346B-KIT for 346B Valves	

VALVES & MANIFOLDS

# DirectoValve® 430 SERIES



430 Flow Back  
Single Valve



430 2-Way  
Single Valve



430 3-Way  
Single Valve

SHUT OFF VALVES	INLET	OUTLET	FLOW RATE (GPM)*	MAX. PRESSURE (PSI)
430, Flowback	75 Series Flange, QC	QC	9.2	215
430, 2-Way	QC, 75 Series Flange	QC	11.7	215
430, 3-Way	QC, 75 Series Flange	QC	11.7	215

**Note:** Flow rates are given for a single valve @ 5 PSI pressure drop and will vary based on the number of valves and inlet sizes.



VALVES & MANIFOLDS





# 437EC-3FBF75-D

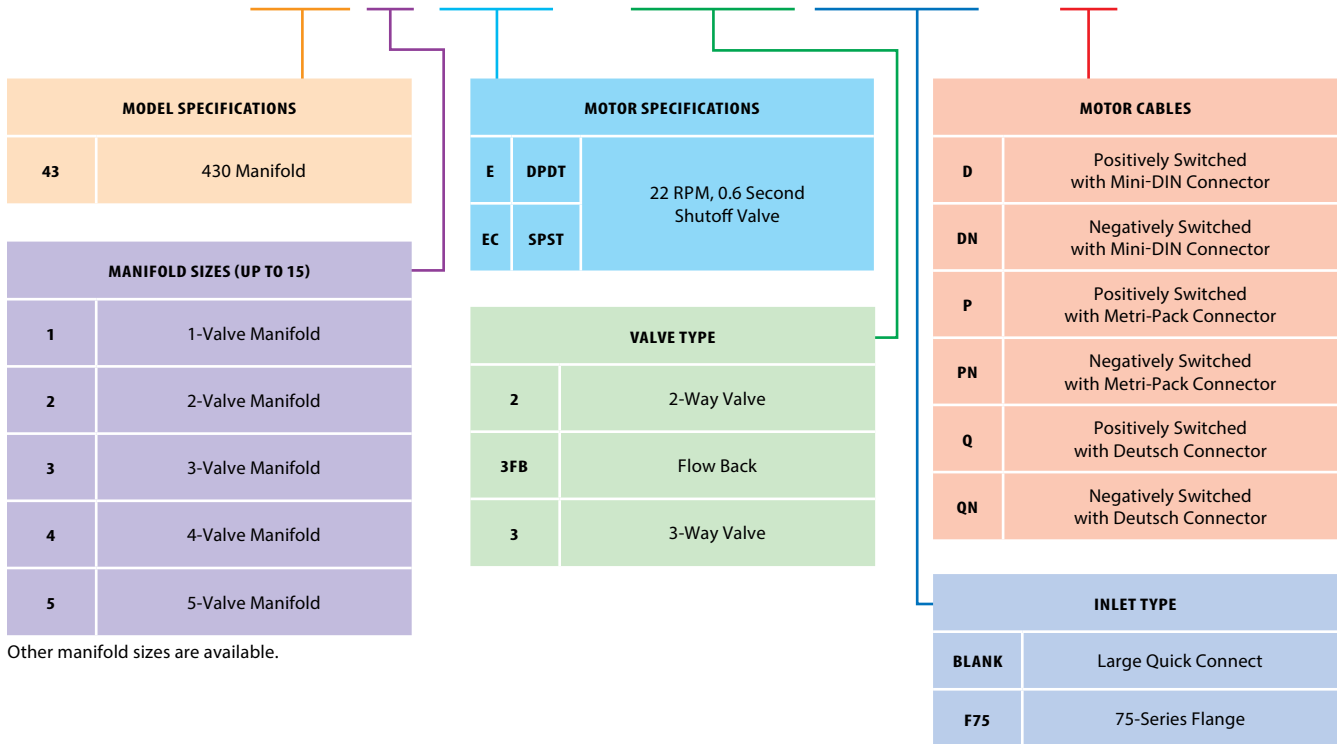

## SAMPLE MINI-DIN CABLE ASSEMBLY PART CODE

# 58480EC-15-VX

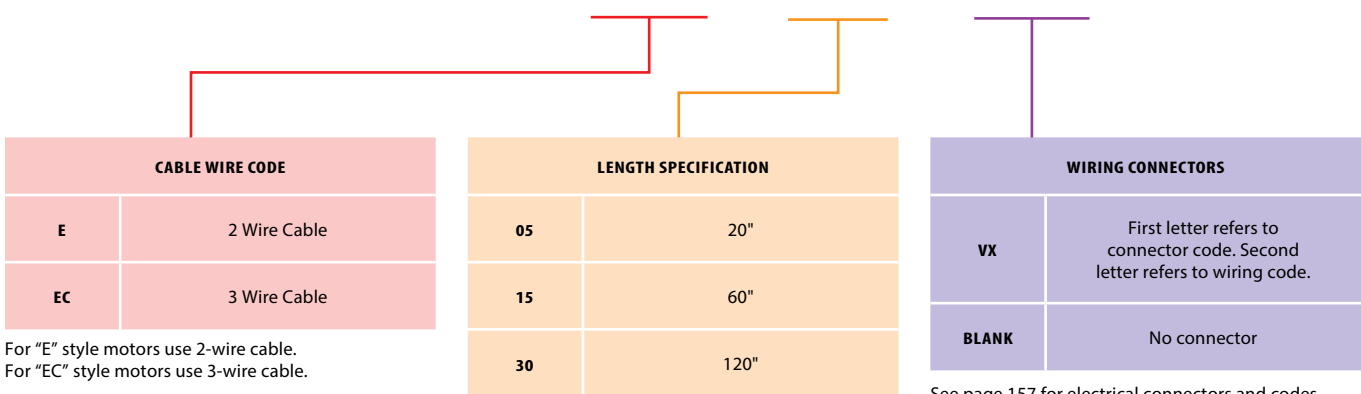

See page 157 for electrical connectors and codes.

# DirectoValve® 400 SERIES



451BEC-2F-P  
Valve



453BEC-3FBF-P  
Manifold



453BEC-2F-P  
Manifold

SHUT OFF VALVES	INLET	OUTLET	FLOW RATE (GPM)*	MAX. PRESSURE (PSI)
<b>440B, 2-Way</b>	¼" or 1" NPT, 1" or 1¼" Hose Barb	¾" or 1", 50 Series Flange, QC	26	300
<b>450B, 2-Way</b>	75 Series Flange	¾" or 1", 50 Series Flange, QC	32	200
<b>450B, Flowback</b>	75 Series Flange	¾" or 1", 50 Series Flange, QC	32	200
<b>460B, 2-Way</b>	50 Series Flange	¾" or 1", 50 Series Flange, QC	25	300
<b>460B, 3-Way</b>	50 Series Flange	¾" or 1", 50 Series Flange, QC	25	300
<b>460B, Flowback</b>	50 Series Flange	¾" or 1", 50 Series Flange, QC	24	115
<b>490B</b>	75 Series Flange	50 Series Flange	100	150

**Note:** Flow rates are given for a single valve @ 5 PSI pressure drop and will vary based on the number of valves and inlet sizes.



# (B)453BEC-3FBFS-C15AB

OUTLET THREADS	
BLANK	All Threads to be NPT (If Equipped)
(B)	All Threads to be BSPT (If Equipped)

MODEL SPECIFICATIONS	
45	450 Manifold

MANIFOLD SIZES	
1	1-Valve Manifold
2	2-Valve Manifold
3	3-Valve Manifold
4	4-Valve Manifold
5	5-Valve Manifold

VALVE TYPE	
3FB	Flow Back
2	2-Way Valve
2N	2-Way Valve, Narrow

END CAPS OR OUTLET FITTINGS	
3	¾" Pipe Thread
4	1" Pipe Thread
Q	Quick Connect
F	50 Series Flange

MOTOR SPECIFICATIONS		
E	DPDT	22 RPM, 0.7 Second Shutoff Valve
EC	SPST	

BALL MATERIAL SPECIFICATIONS	
BLANK	Polypropylene Ball
S	Stainless Steel Ball

MOTOR CABLES	
C	Positively Switched with 0.5-m Cable
C03*	Positively Switched with 0.3-m Cable
C15*	Positively Switched with 1.5-m Cable
C60*	Positively Switched with 6.0-m Cable
D	Positively Switched with DIN Connector
P	Positively Switched with Metri-Pack Connector

Items marked with "\*" are non-stock items. Contact your regional sales office for ordering and availability information. CN (Negatively Switched) motors also available upon request. **Note:** DIN cables must be ordered separately. See page 144 for DIN cables.

WIRING CONNECTORS	
Specify electrical connector style and pin-outs. If no connector is needed leave blank. See page 157 for electrical connectors and codes.	

REPAIR KITS	
AB344AE-KIT	

INLET/OUTLET REQUIRED CONNECTIONS (THE INLET/OUTLET FITTINGS ARE ORDERED SEPARATELY)	
<ul style="list-style-type: none"> <li><b>3, 4:</b> When ordering ¾" (3) or 1" (4) NPT or BSPT threaded connections, the valve outlet connection will be completed during the ordering process.                             <ul style="list-style-type: none"> <li>For the inlets, two 75 Series flange fittings and two 75 Series clamps are required. For the Flow Back ports, two 45529 Quick Connect fittings are required.*</li> </ul> </li> <li><b>F:</b> For the flange fitting versions, one 50 Series single clamp and 50 Series flange fitting is required per valve outlet.                             <ul style="list-style-type: none"> <li>For the inlets, two 75 Series flange fittings and two 75 Series clamps are required. For the Flow Back ports, two 45529 Quick Connect fittings are required.*</li> </ul> </li> <li><b>Q:</b> For Quick Connect versions, one 45529 QC hose barb fitting is required per valve outlet.                             <ul style="list-style-type: none"> <li>For the inlets, two 75 series flange fittings and two 75 Series clamps are required. For the Flow Back ports, two 45529 Quick Connect fittings are required.*</li> </ul> </li> </ul> <p>*See pages 158–159 for flange and Quick Connect fitting options.  <b>Note:</b> Many manifold configurations are possible by mixing and matching flange fittings.</p>	

# DirectoValve® 500 SERIES



MANUAL SHUT OFF VALVES	INLET	OUTLET	FLOW RATE (GPM)*	MAX. PRESSURE (PSI)
530AM, 2-Way	LQC, QC, 50 Series Flange, 75 Series Flange	QC	10	300
530AM, 3-Way	LQC, QC, 50 Series Flange, 75 Series Flange	QC	10	300
ELECTRIC SHUT OFF VALVES	INLET	OUTLET	FLOW RATE (GPM)*	MAX. PRESSURE (PSI)
530AEC, 2-Way	LQC, QC, 50 Series Flange, 75 Series Flange	QC	10	300
530AEC, 3-Way	LQC, QC, 50 Series Flange, 75 Series Flange	QC	10	300
530AEC, Flow Back	LQC, QC, 50 Series Flange, 75 Series Flange	QC	10	300
540EC	75 Series Flange	QC	27	175

**Note:** Flow rates are given for a single valve @ 5 PSI pressure drop and will vary based on the number of valves and inlet sizes.



# 533AEC-2F50-PN

MANIFOLD SIZES (UP TO 15)	
1	1-Valve Manifold
2	2-Valve Manifold
3	3-Valve Manifold
4	4-Valve Manifold
5	5-Valve Manifold

MOTOR SPECIFICATIONS		
AE	DPDT	Electric Shut-Off Valve
AEC	SPST	Electric Shut-Off Valve
AM	MANUAL	Manual Shut-Off Valve

VALVE TYPE	
2	2-Way Valve
3	3-Way Valve
FB	Flow Back (Electric Only)

INLET FITTINGS	
BLANK	Large Quick Connect
F50	50 Series Flange
F75	75 Series Flange
Q	Quick Connect

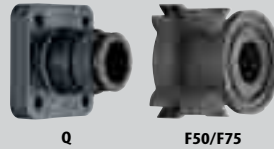

MOTOR CABLES	
D	Positively Switched with Mini-DIN Connector
DN	Negatively Switched with Mini-DIN Connector
P	Positively Switched, with Metri-Pack Connector, No Cable
PN	Negatively Switched, with Metri-Pack Connector, No Cable
Q	Positively Switched with Deutsch Connector
QN	Negatively Switched with Deutsch Connector

REPAIR KITS	
AB530AM-2-KIT	
AB530A-2-KIT	
AB530A-3-KIT	
AB530A-FB-KIT	

**INLET/OUTLET REQUIRED CONNECTIONS (THE INLET/OUTLET FITTINGS ARE ORDERED SEPARATELY)**

- F:** For inlets, two 75 Series clamps and flange fittings or two 50 Series clamps and flange fittings are required. See page 158 for flange fitting options.
- LQ:** For large quick connect inlets, two 58456 fittings are required. See page 159 for LQ fitting options.
- Q:** For Quick Connect inlet and outlet, one 45529 QC hose barb is required per connection. See page 159 for Quick Connect fitting options.

## SAMPLE METRI-PACK CABLE ASSEMBLY PART CODE

# 98546EC-15-VX

CABLE WIRE CODE	
E	2 Wire Cable
EC	3 Wire Cable

LENGTH SPECIFICATION	
05	20"
15	60"
30	120"

WIRING CONNECTORS	
Specify electrical connector style and pin-outs. If no connector is needed leave blank.	
See Page 157 for electrical connectors and codes.	

For "E" style motors use 2-wire cable.  
For "EC" style motors use 3-wire cable.



## CONTROL UNITS

- Pressure relief valve (98510-PP).
- 344BRL electric regulating valve, bypass mode for 98600-C-433E(C) and 98601-B-433E(C) models.
- Liquid strainer (AA126ML-M50-80-VI) for 98600-C-433E(C) and 98601-B-433E(C) models.
- Flowmeter (801A) for 98600-C-433E(C) models.



MODEL NUMBER	VALVE SECTIONS	VALVE TYPE	PRESSURE (PSI)	FLOW PER SECTION
98600-C-433E(C)-2	3	2-Way	215	11.7 GPM (5 PSI Pressure Drop)
98601-C-435E(C)-3FB	5	Flow Back	215	9.2 GPM (5 PSI Pressure Drop)
98602-C-434E(C)-3	4	3-Way	215	11.7 GPM (5 PSI Pressure Drop)
98600-B-433E(C)-2	3	2-Way	215	11.7 GPM (5 PSI Pressure Drop)
98601-B-434E(C)-3FB	4	Flow Back	215	9.2 GPM (5 PSI Pressure Drop)
98602-B-435E(C)-3	5	3-Way	215	11.7 GPM (5 PSI Pressure Drop)
98600-A-437E(C)-2	7	2-Way	215	11.7 GPM (5 PSI Pressure Drop)
98601-A-435E(C)-3FB	5	Flow Back	215	9.2 GPM (5 PSI Pressure Drop)
98602-A-433E(C)-3	3	3-Way	215	11.7 GPM (5 PSI Pressure Drop)

**Note:** Valves can be ordered in 1–9 sections configuration. For inlet and outlet connections refer to page 159.

## 430/530 MANIFOLD ACCESSORIES

MODEL NUMBER	DESCRIPTION
344BRL-B	Bypass Regulating Valve
344BRL-TH	Throttling Regulating Valve
346BEC-2M	2-Way 3-Valve Shutoff Manifold
98510-NYB	Pressure Relief Valve
118560	Compact Pressure Relief Valve
118570	Compact Throttling Valve
AA126ML-M50	Line Strainer
AA122ML-QC	Outlet Strainer
801A	Flowmeter
AB98499-KIT	4-Bolt Flange Accessory Mounting Kit
CP98498-SS	Mounting Bracket



**Note:** TeeJet Technologies recommends the use of sealed connectors to improve reliability and prolong component life.

**CHART 1: CONNECTOR CODES**

2-PIN OR 3-PIN	<p><b>AMP MALE FASTON CONNECTOR</b></p> <p><b>Note:</b> No pin-out code needed with these connectors.</p> <p>2-Pin = Code A      3-Pin = Code J</p>	<p><b>AMP FEMALE FASTON CONNECTOR</b></p> <p><b>Note:</b> No pin-out code needed with these connectors.</p> <p>2-Pin = Code B      3-Pin = Code K</p>
	<p><b>AMP FEMALE MATE-N-LOK® CONNECTOR (SEALED)</b></p> <p>2-Pin = Code C      3-Pin = Code L</p>	<p><b>AMP MALE MATE-N-LOK® CONNECTOR (SEALED)</b></p> <p>2-Pin = Code D      3-Pin = Code M</p>
	<p><b>WEATHER PACK SHROUD CONNECTOR (SEALED)</b></p> <p>2-Pin = Code E      3-Pin = Code O</p>	<p><b>WEATHER PACK TOWER CONNECTOR (SEALED)</b></p> <p>2-Pin = Code F      3-Pin = Code P</p>
	<p><b>DEUTSCH DT FEMALE CONNECTOR (SEALED)</b></p> <p>2-Pin = Code G      3-Pin = Code Q</p>	<p><b>DEUTSCH DT MALE CONNECTOR (SEALED)</b></p> <p>2-Pin = Code H      3-Pin = Code R</p>
	<p><b>METRIPACK FEMALE CONNECTOR (SEALED)</b></p> <p>3-Pin = Code S</p>	<p><b>JST VH FEMALE CONNECTOR (SEALED)</b></p> <p>2-Pin = Code I      3-Pin = Code T</p>
	<p><b>WEATHER PACK SHROUD CONNECTOR (SEALED)</b></p> <p>4-Pin = Code U</p>	<p><b>WEATHER PACK TOWER CONNECTOR (SEALED)</b></p> <p><b>Note:</b> "VX" connector style is used to connect valves to many TeeJet controller harnesses.</p> <p>4-Pin = Code V</p>
	<p><b>DEUTSCH DT FEMALE CONNECTOR (SEALED)</b></p> <p>4-Pin = Code W</p>	

**CHART 2: PIN-OUT CODES**

CODE LETTER	CONNECTOR POSITION				CODE LETTER	CONNECTOR POSITION			
	A OR 1	B OR 2	C OR 3	D OR 4		A OR 1	B OR 2	C OR 3	D OR 4
A	R	W	P	B	M	P	R	W	B
B	R	W	B	P	N	P	R	B	W
C	R	B	W	P	O	P	W	R	B
D	R	B	P	W	P	P	W	B	R
E	R	P	W	B	Q	P	B	R	W
F	R	P	B	W	R	P	B	W	R
G	W	R	B	P	S	B	R	W	P
H	W	R	P	B	T	B	R	P	W
I	W	P	R	B	U	B	W	R	P
J	W	P	B	R	V	B	W	P	R
K	W	B	R	P	W	B	P	R	W
L	W	B	P	R	X	B	P	W	R

For regulating and E-style, 2-wire cables, the white position will be plugged.

## HOW TO ORDER

This system is to be used for ball valves and ball valve manifolds equipped with electrical connectors. Connector and pin-outs are to be specified in valve or manifold part number when ordering. **Note:** On 2-pin connectors, only pin-out code C or S is used.

**First:** Specify code for connector desired (See Chart 1).

**Second:** Specify appropriate wire pin-out arrangement (See Chart 2).

3 5 6 B E C - C L B

Pin-out Code  
Connector Code

### Wire Codes

R = Red (+12V)    W = White (Switched)  
P = Plugged      B = Black (Ground)



## 50 SERIES FLANGED FITTINGS

- Maximum pressure rating of 300 PSI.
- Polypropylene construction.

PART NUMBER	DESCRIPTION
CP48150-PP	3/4" Hose Barb
CP45504-PP	1" Hose Barb
CP45505-PP	1 1/4" Hose Barb
CP45506-PP	1 1/2" Hose Barb
CP48151-PP	90° x 3/4" Hose Barb
CP48152-PP	90° x 1" Hose Barb
CP72238-PP	90° x 1 1/4" Hose Barb
CP72239-PP	90° x 1 1/2" Hose Barb
CP(B)48172-PP	3/4" Male Pipe Thread
CP(B)48155-PP	1" Male Pipe Thread
CP(B)48156-PP	1 1/2" Male Pipe Thread
CP(B)48159-PP	3/4" Female Pipe Thread
CP(B)48154-PP	1" Female Pipe Thread
CP(B)45512-PP	1 1/4" Female Pipe Thread
CP(B, P)45508-1/4-PP	1/4" Gauge Port
CP(B, P)45539-3/8-PP	3/8" Gauge Port
CP45507-PP	Blank Inlet Cover
CP48157-PP	Straight Coupling
CP48158-PP	90° Elbow Coupling
CP46029-PP	Male Quick Connect Adapter
CP50193-PP*	Tee
CP55242-PP*	Narrow Tee
46070**	2-Way 460 Valve Clamp, Nylon
46024**	3-Way 460 Valve Clamp, Nylon
55245-50**	50 Series Flange Clamp, Stainless Steel
CP7717-2/222-VI	50 Series Clamps O-Ring, FKM
CP98491-PP	Bolted Flange Adapter

\*There are no mounting provisions on the 50 Series tee. (B)=BSPT (P)=BSPP  
 \*\*O-ring included.

## 75 SERIES FLANGED FITTINGS

- Maximum pressure rating of 200 PSI.
- Polypropylene construction.

PART NUMBER	DESCRIPTION
CP48160-PP	1 1/4" Hose Barb
CP46067-PP	1 1/2" Hose Barb
CP48161-PP	2" Hose Barb
CP48162-PP	90° x 1 1/4" Hose Barb
CP48163-PP	90° x 1 1/2" Hose Barb
CP48164-PP	90° x 2" Hose Barb
CP(B)48165-PP	1 1/4" Male Pipe Thread
CP(B)48166-PP	1 1/2" Male Pipe Thread
CP(B)48167-PP	2" Male Pipe Thread
CP(B)46066-PP	1 1/2" Female Pipe Thread
CP(B)46127-1/4-PP	1/4" Gauge Port
CP(B)46127-3/8-PP	3/8" Gauge Port
CP46069-PP	Blank Inlet Cover
CP48169-PP	Straight Coupling
CP45207-PP	75 x 50 Series Reducer Coupling
CP48168-PP	90° Elbow Coupling
CP46717-PP	75 x 50 Series Reducer Tee
CP46716-PP	Tee
CP45251-PP	450 Tee Body
CP55224-PP	450 Tee Body (Narrow)
55245-75**	75 Series Flange Clamp, Stainless Steel
CP7717-2-229-VI	75 Series Clamps O-Ring, FKM
CP98490-PP	F75 Bolted Flange Adapter

\*\*O-ring included. (B)=BSPT (P)=BSPP

## 48143 MOUNTING KIT

Mounts to underside of tee and includes one extrusion and four screws. Mounting kit is not included with tees. Must be ordered separately. Also requires 5/16" or 8 mm bolt.

PART NUMBER	DESCRIPTION
48143	Tee Mounting Kit (450 or 490 Series Manifold)



45529-1/2



45529-C



45529-PTC-4-3/8



45529-90-1



CP46029-PP



CP45527-NYB



CP45527-NYB



45529-P



58456-1-1/4



58456-1000



58456-90-1000



58456-C



116240-LM



58456-P



58456-1250M

## QUICK CONNECT FITTINGS

- Use on valves and components equipped with Quick Connect outlets.
- Rated to 300 PSI.

PART NUMBER	DESCRIPTION
45529-C	Quick Connect Cap (F)
45529-P	Quick Connect Plug (M)
45529-3/8*	3/8" Straight Hose Barb (F)
45529-1/2*	1/2" Straight Hose Barb (F)
45529-5/8*	5/8" Straight Hose Barb (F)
45529-3/4*	3/4" Straight Hose Barb (F)
45529-1*	1" Straight Hose Barb (F)
45529-90-1/2*	1/2" 90° Hose Barb (F)
45529-90-5/8*	5/8" 90° Hose Barb
45529-90-3/4*	3/4" 90° Hose Barb (F)
45529-90-1*	1" 90° Hose Barb (F)
45529-90-1-1/4*	1 1/4" 90° Hose Barb
45529-3/4M	3/4" Hose Barb (M)*
45529-1M	1" Hose Barb (M)*
CP46029-PP	50 Series Flange (M)
CP45527-NYB	3/4" Male Pipe Thread
CP45526-NYB	1" Male Pipe Thread
45529-QT	Quick TeeJet Straight Fitting
45529-PTC-4-3/8	4 x 3/8" PTC Quick Connect Fitting
CP37166-1-302SS	Retaining Clip 302SS
CP7717-3-912-VI	O-Ring (FKM)
CP116237-NYB	QC Bolted Flange Adapter

\*Includes Retaining Clip and O-Ring.

## LARGE QUICK CONNECT FITTINGS

- Used for 430 and 530 manifold inlets and select ball valves.
- Rated to 215 PSI.

PART NUMBER	DESCRIPTION
58456-C	Cap Fitting
58456-P	Plug Fitting
(B)58456-1/4	1/4" Female Thread (Gauge Port)
(B)58456-3/4	3/4" Female Thread (Gauge Port)
(B)58456-1	1" Female Thread (Gauge Port)
(B)58456-1-1/4	1 1/4" Female Thread (Gauge Port)
(B)58456-1-1/2	1 1/2" Female Thread (Gauge Port)
58456-1000	1" Straight Hose Barb
58456-1250	1 1/4" Straight Hose Barb
58456-1500	1 1/2" Straight Hose Barb
58456-2000	2" Straight Hose Barb
58456-90-1000	1" 90° Hose Barb
58456-90-1250	1 1/4" 90° Hose Barb
58456-90-1500	1 1/2" 90° Hose Barb
58456-90-2000	2" 90° Hose Barb
58456-1250M	1 1/4" Hose Barb
58456-1500M	1 1/2" Hose Barb
116240-LM*	Tee
CP37166-1-302SS	Retaining Clip 302SS
CP7717-M40X4-VI	O-Ring (FKM)
CP98497-PP	LQC Bolted Flange Adapter

Note: Retaining Clip and O-Ring included.

(B)=BSPT

\*Includes 3 O-Rings and 3 Retaining Clips.

### AA144P-, AA144A- & AA145H- DIRECTOVALVE CONTROL VALVES

- Direct acting; large internal flow chamber without pilot hole reduces chance of clogging.
- Stainless steel wetted parts provide additional corrosion resistance.
- Operate on 12 VDC system.
- Maximum pressure of 100 PSI.
- Encapsulated solenoid coil can be changed without removing valve from system.
- EPDM diaphragms and seat washers, FKM optional.
- Continuous flow through bypass connection, with flow to spray line controlled by valve "on-off" action.

### AA144P DIRECTOVALVE CONTROL VALVES

- Flow Rate: 10 GPM at 5 PSI pressure drop, 14 GPM at 10 PSI pressure drop.
- 2.5 AMP current draw.
- Polypropylene body for chemical resistance.
- Fabric reinforced FKM diaphragms and seat washers.
- No stroke adjustment required.
- Corrosion resistant, 430SS solenoid grade armature and armature stop.
- Encapsulated coil and magnetic circuit.

MODEL NUMBER	INLET SIZE	OUTLET SIZE	CURRENT DRAW
AA(B)144P-*	¾"	½"	2.5 AMP

(B) = BSPT



### AA144A VALVE FOR PRESSURES UP TO 100 PSI

- Flow Rate: 10 GPM at 5 PSI pressure drop, 14 GPM at 10 PSI pressure drop.
- Can be ganged with other 144A DirectoValve control valves.
- 2.5 AMP current draw.
- Polypropylene body for chemical resistance.
- Fabric reinforced diaphragms.
- Also available as 2- or 3-unit assembly.

MODEL NUMBER	INLET SIZE	OUTLET SIZE	CURRENT DRAW
AA(B)144A-*	¾"	½"	2.5 AMP

(B) = BSPT

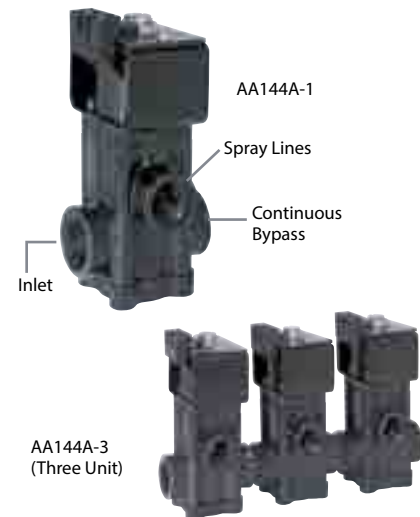

### AA145H CONTROL VALVES

- Flow Rate: 15 GPM at 5 PSI pressure drop, 21 GPM at 10 PSI pressure drop.
- Can be ganged with other 145H DirectoValve control valves.
- 2.9 AMP current draw.
- Fiberglass reinforced Nylon body.

MODEL NUMBER	INLET SIZE	OUTLET SIZE	CURRENT DRAW
AA145H-1	1"	1"	2.9 AMP







AA144P-1-3

### AA144P-1-3 DIRECTOVALVE CONTROL VALVES

The 144P-1-3 three-way solenoid-operated DirectoValve control valve was specifically designed to provide bypass control in spraying applications. When used with part number 23520-PP throttling valve or a 4916 metering orifice plate in the bypass line, it can provide for a constant pressure spray system.

- For pressure to 65 PSI .
- Flow Rate: 8 GPM at 5 PSI pressure drop, 11 GPM at 10 PSI pressure drop.
- Fabric-reinforced FKM diaphragms.
- Nylon encapsulated 12 VDC coil with ¼" Quick Connect terminals.
- Power requirement 2.5 AMP.
- Glass-filled polypropylene (black) valve body.
- Internal metal parts are stainless steel.
- No stroke adjustment needed.
- Corrosion resistant, 430SS solenoid grade armature and armature stop.



AA144P-3-3  
(Three Unit)

### AA144A-1-3 DIRECTOVALVE CONTROL VALVES

The three-way solenoid-operated DirectoValve control valve bypasses boom flow to maintain constant spraying pressure when one or more boom sections are shut off. To maintain pressure with a 23520 Throttling Valve, Outlet 2 must be throttled to match the total capacity of the nozzles on that boom section.

- For pressures to 65 PSI.
- Flow Rate: 8 GPM at 5 PSI pressure drop, 11 GPM at 10 PSI pressure drop.
- 2.5 AMP current draw.
- Encapsulated 12 VDC coil can be easily changed without removing valve from line.
- Polypropylene body for chemical resistance.
- Stainless steel internal metal parts.
- Chemical resistant EPDM diaphragms and seat washers.



AA144A-3-3  
(Three Unit)

MODEL NUMBER	NUMBER OF UNITS IN ASSEMBLY	SPRAY LINE CONNECTION	CONTINUOUS FLOW INLET BYPASS CONNECTION
AA(B)144P-1-3	1	½"	¾"
AA(B)144P-2-3	2	½"	¾"
AA(B)144P-3-3	3	½"	¾"
AA(B)144A-1-3	1	½"	¾"
AA(B)144A-2-3	2	½"	¾"
AA(B)144A-3-3	3	½"	¾"

(B) = BSPT



AA144A-1-3



AA(B)344M-NYB

### 344M-NYB 2-WAY NYLON MANUAL BALL VALVES

- Quarter turn of handle from shutoff to full flow.
- $\frac{3}{4}$ " or 1" NPT and BSPT (F) connection.
- Wetted parts: Nylon, PTFE, polypropylene, and FKM.

#### AA(B)344M-NYB

VALVE NUMBER	MAXIMUM PRESSURE (PSI)	NUMBER OF OUTLETS	CONNECTION SIZE
AA(B)344M-2-3/4	300	1	$\frac{3}{4}$ "
AA(B)344M-2-1		1	1"

Flow Rate: 5 PSI pressure drop for 32 GPM flow.

(B) = BSPT



AA(B)343M-PP

### 340M-PP SERIES 2-WAY MANUAL BALL VALVES

- Quarter turn of handle from shutoff to full flow.
- $\frac{3}{8}$ ",  $\frac{1}{2}$ ",  $\frac{3}{4}$ ", 1",  $1\frac{1}{4}$ " or  $1\frac{1}{2}$ " NPT and BSPT (F) connection.
- Wetted parts: glass-reinforced polypropylene, PTFE, and FKM.

#### AA(B)343M-PP

VALVE NUMBER	MAXIMUM PRESSURE (PSI)	NUMBER OF OUTLETS	CONNECTION SIZE
AA(B)343M-2-3/8-PP	150	1	$\frac{3}{8}$ "
AA(B)343M-2-1/2-PP		1	$\frac{1}{2}$ "

Flow Rate: 5 PSI pressure drop for 11 GPM flow.

(B) = BSPT



AA(B)344M-PP

#### AA(B)344M-PP

VALVE NUMBER	MAXIMUM PRESSURE (PSI)	NUMBER OF OUTLETS	CONNECTION SIZE
AA(B)344M-2-3/4-PP	125	1	$\frac{3}{4}$ "
AA(B)344M-2-1-PP		1	1"

Flow Rate: 5 PSI pressure drop for 32 GPM flow.

(B) = BSPT



AA(B)346M-PP

#### AA(B)346M-PP

VALVE NUMBER	MAXIMUM PRESSURE (PSI)	NUMBER OF OUTLETS	CONNECTION SIZE
AA(B)346M-2-1-1/4-PP	125	1	$1\frac{1}{4}$ "
AA(B)346M-2-1-1/2-PP		1	$1\frac{1}{2}$ "

Flow Rate: 5 PSI pressure drop for 100 GPM flow.

(B) = BSPT



AA(B)344M-NYB

### 344M-NYB 3-WAY NYLON MANUAL BALL VALVES

- 3-way version diverts flow to either outlet; no shutoff.
- 3/4" or 1" NPT and BSPT (F) connection.
- Wetted parts: Nylon, PTFE, polypropylene, and FKM.

#### AA(B)344M-NYB

VALVE NUMBER	MAXIMUM PRESSURE (PSI)	NUMBER OF OUTLETS	CONNECTION SIZE
AA(B)344M-3-3/4	300	2	3/4"
AA(B)344M-3-1		2	1"

Flow Rate: 5 PSI pressure drop for 24 GPM flow.

(B) = BSPT



AA(B)343M-PP

### 340M-PP SERIES 3-WAY MANUAL BALL VALVES

- 3-way version diverts flow to either outlet; no shutoff.
- 3/8", 1/2", 3/4", 1", 1 1/4" or 1 1/2" NPT and BSPT (F) connection.
- Wetted parts: glass-reinforced polypropylene, PTFE, and FKM.

#### AA(B)343M-PP

VALVE NUMBER	MAXIMUM PRESSURE (PSI)	NUMBER OF OUTLETS	CONNECTION SIZE
AA(B)343M-3-3/8-PP	150	2	3/8"
AA(B)343M-3-1/2-PP		2	1/2"

Flow Rate: 5 PSI pressure drop for 8 GPM flow.

(B) = BSPT



AA(B)344M-PP

#### AA(B)344M-PP

VALVE NUMBER	MAXIMUM PRESSURE (PSI)	NUMBER OF OUTLETS	CONNECTION SIZE
AA(B)344M-3-3/4-PP	125	2	3/4"
AA(B)344M-3-1-PP		2	1"

Flow Rate: 5 PSI pressure drop for 24 GPM flow.

(B) = BSPT



AA(B)346M-PP

#### AA(B)346M-PP

VALVE NUMBER	MAXIMUM PRESSURE (PSI)	NUMBER OF OUTLETS	CONNECTION SIZE
AA(B)346M-3-1-1/4-PP	125	2	1 1/4"
AA(B)346M-3-1-1/2-PP		2	1 1/2"

Flow Rate: 5 PSI pressure drop for 64 GPM flow.

(B) = BSPT

### PISTON-TYPE PRESSURE RELIEF/REGULATING VALVES

Bypasses excess liquid. Adjustable to maintain control of line pressure at any pressure within the valve's operating range. Selected pressure setting firmly held in place by locknut. Extra-large valve passages to handle large flows.



23120



6815



110-1/4 &  
110-3/8



110-1, 110-1-1/4  
& 110-1-1/2



8460

### 23120

- 302 stainless steel spring and EPDM O-ring.
- Excellent chemical resistance.
- 1/4" port for pressure gauge pipe plug included.

VALVE NUMBER	INLET & PIPE CONNECTIONS	MATERIAL	PRESSURE RANGE (PSI)
(B)23120-*-PP	1/2" or 3/4"	Polypropylene	150
(B)23120A-*-PP	1/2" or 3/4"	Polypropylene	150
(B)23120-*-PP-60	1/2" or 3/4"	Polypropylene	60
(B)23120-*-PP-60-VI	1/2" or 3/4"	Polypropylene	60

\*Specify pipe size.

(B) = BSPT

### 6815

- Other models for high pressures up to 1,200 PSI are also available.
- Also available with hardened stainless steel seat.

VALVE NUMBER	INLET & PIPE CONNECTIONS	MATERIAL	PRESSURE RANGE (PSI)
(B)6815-*-50	1/2" or 3/4"	Brass	50
(B)6815-*-300	1/2" or 3/4"	Brass	300
(B)6815-*-700	1/2" or 3/4"	Brass	700

\*Specify pipe size.

(B) = BSPT

### 110

- Removable bonnet for servicing unit without removing valve from line.

VALVE NUMBER	INLET & PIPE CONNECTIONS	MATERIAL	PRESSURE RANGE (PSI)
AA(B)110-*-50	1/4" or 3/8"	Brass	50
AA(B)110-*-150	1/4" or 3/8"	Brass	150
AA(B)110-*-300	1/4" or 3/8"	Brass	300
AA(B)110-*-700	1/4" or 3/8"	Brass	700
AA(B)110-1	1"	Brass, Aluminum or Ductile Iron	150
AA(B)110-1-1/4	1 1/4"	Brass, Aluminum or Ductile Iron	150
AA(B)110-1-1/2	1 1/2"	Brass, Aluminum or Ductile Iron	150

\*Specify pipe size.

(B) = BSPT

### 8460 DIAPHRAGM-TYPE PRESSURE RELIEF/ REGULATING VALVES

- Flow rate to 56 GPM for 1/2" and 70 GPM for 3/4".
- 8460-\*-50 uses stainless steel springs while 8460-\*-300 uses steel springs—responsive to the pressure range of each valve.
- Extra-large valve passages to handle full flow from supply line.
- Positive locknut to hold adjustment screw firmly in place. Not affected by jarring and vibration.

VALVE NUMBER	INLET & PIPE CONNECTIONS	MATERIAL		PRESSURE RANGE (PSI)
		INLET BODY	BONNET	
8460-*-50	1/2" or 3/4"	Nylon	Aluminum	50
8460-*-300	1/2" or 3/4"	Nylon	Aluminum	300

\*Specify pipe size.

(B) = BSPT

# DirectoValve® MANUAL CONTROL VALVE

## AA6B

- Molded of corrosion resistant materials; all wetted parts are polypropylene, stainless steel and polyethylene.
- Maximum pressure of 150 PSI.
- Flow Rate: 12 GPM at 5 PSI pressure drop, 17 GPM at 10 PSI pressure drop.
- Molded-in mounting flange and ¼" NPT gauge port.
- Valves can be ganged together using hex nipple for multiple boom control.
- Easily repaired without removing valve from spray line.



# TeeValve® CONTROL VALVES

## AA17

For selective control of three-section boom sprayers at pressures up to 300 PSI.

- Use to open any of three boom section lines in any desired combination.
- Raise lever to open, lower lever to close the valve without changing the indexed position.
- Aluminum construction with stainless steel and plastic internal parts for maximum corrosion resistance.

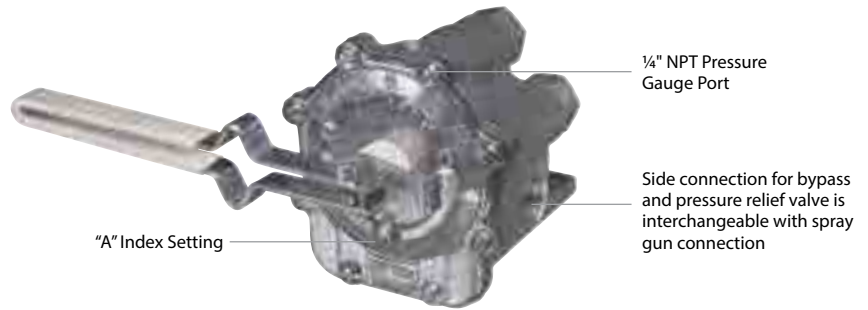

VALVE NUMBER	MATERIAL	MAXIMUM PRESSURE	INLET	(3) BOOM OUTLETS	ACCESSORY OUTLET
AA17Y	Aluminum, Polymer, SS	300 PSI	1" NPT	¾" (F)	¾" (F)
AA17L	Aluminum, Polymer, SS	300 PSI	¾" NPT	¾" (F)	¾" (F)

# TeeJet® THROTTLING VALVES

## 23520, 12690 & 12795

For regulating flow in systems equipped with centrifugal pumps where sensitive regulation is required or to control flow in jet agitator return lines. Locknut holds pressure setting firmly in place.



23520



12795



12690

VALVE NUMBER	INLET & PIPE CONNECTIONS	MATERIAL	PRESSURE RANGE
23520	½" and ¾" NPT or BSPT	Polypropylene	150 PSI
12690	½" or ¾" NPT	Nylon, Acetal, Aluminum, Steel, Stainless Steel	125 PSI
12795	1", 1¼" or 1½" NPT	Brass, Aluminum, Ductile Iron	150 PSI

\*Specify pipe size.

(B) = BSPT



# TeeJet® TIP STRAINERS



## STRAINERS

Strainers protect spray tip orifices from clogging and damage. Stainless steel screens are available in 24, 50, 80, 100 and 200 mesh.

MESH SIZE
16
20
24
25/30
50/60
80
100
120
200

**Note:** Strainers color code follows the ISO 19732 standards.

TEEJET STRAINER NUMBER	STRAINER BODY & CAP MATERIAL	MESH SCREEN MATERIAL
8079-PP-*	Polypropylene	Stainless Steel
5053-SS	Brass	Stainless Steel
6051-SS-*	Stainless Steel	Stainless Steel

\*Specify mesh size when ordering.

## 55215 SELF-RETAINING TIP STRAINER

For use with Quick TeeJet caps. Allows tip strainer to be easily removed from nozzle body for cleaning. 50 or 100 mesh color-coded strainer with optional EPDM or FKM gasket.



### HOW TO ORDER

55215-50-EPR, EPDM gasket  
55215-50-VI, FKM gasket

STRAINER NUMBER	MESH
55215-50-*	50
55215-100-*	100

\*Identify gasket material.

## SLOTTED STRAINERS

One-piece strainers for use with liquids containing suspended solids.



TEEJET STRAINER NUMBER	AVAILABLE MATERIAL	EQUIVALENT TO MESH SIZE	COLOR CODE (NYLON VERSIONS ONLY)
4514-*-10	Brass or Nylon	50	50
4514-*-20	Brass, Aluminum or Nylon	25	25
4514-*-32	Brass, Aluminum or Nylon	16	16

\*Above numbers for brass. For Nylon add "NY". For aluminum add "AL".

## 4193A & 4193B STRAINER & CHECK VALVE

Minimizes nozzle dripping; fits with all TeeJet Nozzle Bodies. 4193B offered with a choice of 5 PSI or 10 PSI, 4193A offered with a choice of 20 PSI or 40 PSI spring. Recommended for flow rates up to 0.8 GPM. 24, 50, 100 and 200 mesh screens. Not for use with AI, DG, or TTI tips.



**Note:** Use of these ball check valves results in a pressure drop equivalent to the opening pressure rating.

CHECK VALVE NUMBER	BODY & CAP SCREW MATERIAL	MESH SCREEN MATERIAL	BALL MATERIAL
4193A/B- *- *	Brass	Stainless Steel	Stainless Steel
4193A/B-SS- *- *	Stainless Steel	Stainless Steel	Stainless Steel
4193A/B-PP- *- *	Polypropylene	Stainless Steel	FKM
4193A/B-PP-SS-*	Polypropylene	Stainless Steel	Stainless Steel

\*When ordering, specify A or B, spring rating and screen mesh size.

# TeeJet® LINE STRAINERS

The AA122 line strainer features a compact size that is well suited for small agricultural and turf sprayers. The AA122 is constructed of a polypropylene head and bowl with stainless steel screen for excellent chemical resistance and is available with 1/2" or 3/4" (F) NPT pipe connections.

The maximum pressure rating is 150 PSI. A Quick Connect version of the 122 is also available for easy installation on valves/manifolds equipped with Quick Connect outlets. The maximum pressure rating for this version is 215 PSI.

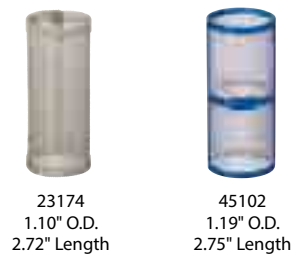

## 37270-122-PP

The screen may be periodically flushed by opening a valve (valve not included) in flush-out line.

STRAINER NUMBER	PIPE CONN.	APPROXIMATE FLOW RATE WITH 5 PSI PRESSURE DROP IN GPM	SCREEN	
			MESH SIZE	PART NUMBER
AA122ML-QC-PP-*	QC	18		
AA(B)122-1/2-PP-*	1/2"	12	16	CP23174-1-3045S
AA(B)122-3/4-PP-*	3/4"	16	30	CP23174-2-3045S
AA(B)122ML-1/2-PP-*	1/2"	12	50	CP45102-3-SSPP
AA(B)122ML-3/4-PP-*	3/4"	16	80	CP45102-4-SSPP
(B)37270-122-1/2-PP-*	1/2"	12	100	CP45102-5-SSPP
(B)37270-122-3/4-PP-*	3/4"	16	200	CP23174-7-3045S

\* = Mesh Size

(B) = BSPT

**Replacement Head Gasket:** CP23173-EPR(-VI) or CP7717-M38x4-VI (for AA122ML-QC only).

**Note:** Strainers color code follows the ISO 19732 standards.



AA126ML-F50



AA126ML-3 or -4

**AA126 FLUSH-OUT LINE STRAINER**

- 200 PSI maximum pressure rating.
- Strainer head and bowl are made of glass-filled polypropylene with EPDM gasket.
- Screens are made of 304SS with color-coded polypropylene frames and are removable for cleaning.
- Removable cap and O-ring for flush-out or self-cleaning operations.
- Integral mounting provision allows the strainer to be attached to machine using M8 or 5/16" diameter bolts.
- Available with 3/4", 1" NPT or BSPT (F) threads and 50 series flange fitting connections for easy assembly. For information on flange fittings see page 158.
- Uses same screen as the AA124A line strainer.



16903  
1.38" O.D.  
5.75" Length

STRAINER NUMBER	PIPE/FLANGE CONNECTION (F)	FLOW RATE WITH 5 PSI PRESSURE DROP	SCREEN	MESH SIZE*
AA(B)126ML-F50-*	50 Series Flange	35 GPM	CP16903-1-SSPP	16
			CP16903-3-SSPP	30
AA(B)126ML-3-*	3/4"	23 GPM	CP16903-4-SSPP	50
			CP16903-5-SSPP	80
AA(B)126ML-4-*	1"	35 GPM	CP16903-6-SSPP	100
			CP16903-7-SSPP	200

\*Specify mesh size

**Replacement Head Gasket:** CP7717-2/228-EPR (-VI)

**Note:** Strainers color code follows the ISO 19732 standards.



AA126ML-F75



AA126ML-5 or -6

**AA126 FLUSH-OUT LINE STRAINER**

- 200 PSI maximum pressure rating.
- Strainer head and bowl are made of glass-filled polypropylene with EPDM gasket.
- Screens are made of 304SS with color-coded polypropylene frames and are removable for cleaning.
- Removable cap and gasket for flush-out or self-cleaning operations.
- Integral mounting provision allows the strainer to be attached to machine using M10 or 3/8" diameter bolts.
- Available with 1 1/4", 1 1/2" NPT or BSPT (F) threads and 75 series flange fitting connections for easy assembly. For information on flange fittings see page 158.
- Uses same screen as the AA124 line strainer.



15941  
2.25" O.D.  
7.63" Length

STRAINER NUMBER	PIPE/FLANGE CONNECTION (F)	FLOW RATE WITH 5 PSI PRESSURE DROP	SCREEN	MESH SIZE*
AA(B)126ML-F75-*	75 Series Flange	77 GPM	CP15941-1-SSPP	16
			CP15941-2-SSPP	30
AA(B)126ML-5-*	1 1/4"	59 GPM	CP15941-3-SSPP	50
			CP15941-4-SSPP	80
AA(B)126ML-6-*	1 1/2"	77 GPM	CP15941-5-SSPP	100
			CP15941-6-SSPP	120

\*Specify mesh size

**Replacement Head Gasket:** CP48656-EPR(-VI)

**Note:** Strainers color code follows the ISO 19732 standards.

## SELF-CLEANING LINE STRAINERS

The TeeJet self-cleaning strainer extends your spraying time with a self-cleaning feature that minimizes clogging. Mounted on the discharge side of the pump, the strainer uses excess pump flow to bypass clogging particles back to the spray tank.

The tapered inner cylinder inside the entire length of the screen provides a gap between the screen face and the cylinder. This gap causes the inlet fluid to flow at a high velocity past the screen face providing for a continuous wash down of particles to the bypass line. In order for the wash down to occur, a minimum flow rate of 6 GPM for ¾" and 1" sizes and 8 GPM for 1¼" and 1½" sizes is required through the bypass line.

- Available with or without mounting lugs.
- AA126 strainers are made of glass filled polypropylene and are available in ¾", 1", 1¼", 1½" (F) NPT or BSPT thread as well as 50 and 75 series flange connection.
- AA124 strainers are made of an aluminum head with a nylon bowl and are available in ¾", 1", 1¼", 1½" (F) NPT or BSPT thread.
- Both use an all stainless steel strainer element.
- Strainers with mounting lugs are designated by "ML".



AA(B)126MLSC  
(Glass-filled Polypropylene)



AA(B)124ML-SC-AL  
(Aluminum)



AA(B)124-SC-AL  
(Aluminum)

STRAINER NUMBER	PIPE CONN.	BYPASS PIPE CONN.	MATERIAL		MAX. PRESSURE (PSI)	MIN. BYPASS REQUIRED (GPM)	SCREEN		
			HEAD	BOWL			MESH	NUMBER	
AA(B)126MLSC-3-*	¾" (F)	½" (F)	Polypropylene		200	6	16	CP12285-*SS	
AA(B)124ML-3/4SC-AL-*			Aluminum	Nylon	150		30		
AA(B)126MLSC-4-*	1" (F)		Polypropylene		200		50		80
AA(B)124ML-1SC-AL-*			Aluminum	Nylon	150				
AA(B)126MLSC-F50-*	Flange	¾" (F)	Polypropylene		200	8	100	CP12290-*SS	
AA(B)126MLSC-5-*	1¼" (F)		Polypropylene		200				
AA(B)124ML-1-1/4SC-AL-*		1½" (F)	Aluminum	Nylon	150				
AA(B)126MLSC-6-*	Polypropylene		200						
AA(B)124ML-1-1/2SC-AL-*	Flange	Aluminum		Nylon	150	200			
AA(B)126MLSC-F75-*		Polypropylene		200					

**Replacement Head Gaskets:** 126-3, -4, -F50: CP50494-EPR (-VI); 126-5, -6, -F75: CP48656-VI; 124-3/4, -1: CP7717-2/226-VI; 124-1-1/4, -1-1/2: CP12291-VI

STRAINER NUMBER	PIPE CONN.	BYPASS PIPE CONN.	MATERIAL		MAX. PRESSURE (PSI)	MIN. BYPASS REQUIRED (GPM)	SCREEN	
			HEAD	BOWL			MESH	NUMBER
AA(B)124A-3/4SC-AL-*	¾" (F)	½" (F)	Aluminum	Nylon	150	6	16	CP12285-*SS
AA(B)124A-1SC-AL-*	1" (F)						30	
AA(B)124A-1-1/4SC-AL-*	1¼" (F)	80						
AA(B)124A-1-1/2SC-AL-*	1½" (F)	30						
		¾" (F)				8	80	CP12290-*SS
		1½" (F)					100	

## HOW TO ORDER

AA126MLSC-4-50

Specify strainer number.

CP12285-1-SS

To order screen only, specify screen number.

SCREEN		
MESH	SCREEN NUMBER	SCREEN NUMBER
16	CP12285-1-SS	CP12290-1-SS
30	CP12285-4-SS	CP12290-2-SS
50	CP12285-2-SS	CP12290-3-SS
80	CP12285-3-SS	CP12290-4-SS
100	CP12285-6-SS	CP12290-8-SS



12285  
1.37" O.D.  
5.75" Length



12290  
2.25" O.D.  
7.94" Length

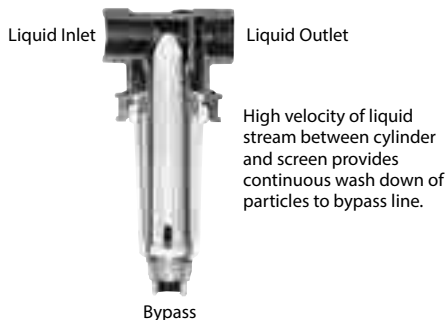

Strainer heads are available in aluminum and cast iron. Bowl material is Nylon. Each strainer includes stainless steel screen (with polypropylene frames on 3/4" to 1 1/2" pipe sizes). Maximum temperatures up to 100°F. FKM O-ring seal supplied with 3/4" and 1" models; Buna-N gaskets supplied with 1 1/4", 1 1/2", 2" and 2 1/2" sizes. FKM optional.



AA(B)124A-AL



16903  
1.38" O.D.  
5.75" Length



AA(B)124-AL



15941  
2.28" O.D.  
7.63" Length



14634  
3.19" O.D.  
9.75" Length



AA(B)124ML-AL  
(with mounting holes)



16903  
1.38" O.D.  
5.75" Length



15941  
2.25" O.D.  
7.63" Length



14634  
3.19" O.D.  
9.75" Length

## HOW TO ORDER

AA(B)124-1-1/4-NYB-16 (Nylon)

Specify strainer number, mesh size and material.

CP15941-1-SSPP

To order screen only, specify screen number.

STRAINER NUMBER	PIPE CONN.	APPROXIMATE FLOW RATE WITH 5 PSI PRESSURE DROP IN GPM	PRESSURE RATING PSI	SCREEN	
				MESH SIZE	PART NUMBER
AA(B)124A-3/4-AL*	3/4"	23	150	16	CP16903-1-SSPP
				20	CP16903-2-SSPP
				30	CP16903-3-SSPP
				50	CP16903-4-SSPP
AA(B)124A-1-AL*	1"	34	150	80	CP16903-5-SSPP
				100	CP16903-6-SSPP
				200	CP16903-7-SSPP

\* = Mesh Size

(B) = BSPT

Replacement Head O-Ring: CP7717-2/226-VI

STRAINER NUMBER	PIPE CONN.	APPROXIMATE FLOW RATE WITH 5 PSI PRESSURE DROP IN GPM	PRESSURE RATING PSI	SCREEN	
				MESH SIZE	PART NUMBER
AA(B)124-1-1/4-AL*	1 1/4"	60	150	16	CP15941-1-SSPP
				30	CP15941-2-SSPP
				50	CP15941-3-SSPP
AA(B)124-1-1/2-AL*	1 1/2"	70	150	80	CP15941-4-SSPP
				100	CP15941-5-SSPP
AA(B)124-2-AL*	2"	160	150	120	CP15941-6-SSPP
				16	CP14634-1-SS
AA(B)124-2-1/2-AL*	2 1/2"	170	150	30	CP14634-2-SS
				50	CP14634-3-SS
				80	CP14634-4-SS
				100	CP14634-8-SS

\* = Mesh Size

(B) = BSPT

Replacement Head Gasket: 124-1-1/4, 1-1/2: CP12291-BU(-VI);  
124-2, -2-1/2: CP14833-BU

STRAINER NUMBER	PIPE CONN.	APPROXIMATE FLOW RATE WITH 5 PSI PRESSURE DROP IN GPM	PRESSURE RATING PSI	SCREEN	
				MESH SIZE	PART NUMBER
AA(B)124ML-3/4-AL*	3/4"	23	150	16	CP16903-1-SSPP
				20	CP16903-2-SSPP
				30	CP16903-3-SSPP
				50	CP16903-4-SSPP
AA(B)124ML-1-AL*	1"	34	150	80	CP16903-5-SSPP
				100	CP16903-6-SSPP
				200	CP16903-7-SSPP
				16	CP15941-1-SSPP
AA(B)124ML-1-1/4-AL*	1 1/4"	60	150	30	CP15941-2-SSPP
				50	CP15941-3-SSPP
				80	CP15941-4-SSPP
AA(B)124ML-1-1/2-AL*	1 1/2"	70	150	100	CP15941-5-SSPP
				120	CP15941-6-SSPP
AA(B)124ML-2-AL*	2"	160	150	16	CP14634-1-SS
				30	CP14634-2-SS
AA(B)124ML-2-1/2-AL*	2 1/2"	170	150	50	CP14634-3-SS
				80	CP14634-4-SS
				100	CP14634-8-SS

\* = Mesh Size

(B) = BSPT

For spot spraying, tree spraying, and livestock spraying at pressures from 30 PSI to 800 PSI.

To operate spray gun, handle is rotated 360° from shutoff to maximum flow position. As handle is turned, spray changes from initial cone spray through intermediate cone spray to straight stream. Spray tips are interchangeable orifice discs made of corrosion- and erosion-resistant stainless steel.

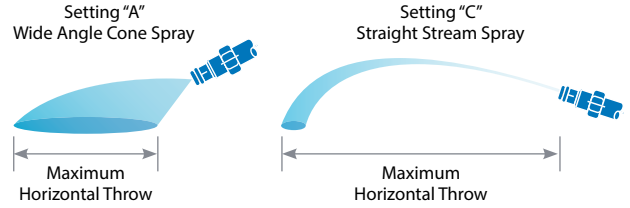

## AA143

Overall length 22¼", weight 1.25 pounds and only available in aluminum. Inlets are available with ¾" or GH (garden hose) female threads.



### HOW TO ORDER

AA143-AL-3/4-6

AA143-AL-GH-6

D 2

To order orifice disc only, specify orifice disc number.

GUNJET NUMBER	ORIFICE DISC NUMBER	PERFORMANCE	LIQUID PRESSURE IN PSI			
			100 PSI		800 PSI	
			A	C	A	C
AA143-AL*-2	D2	Capacity (GPM)	.36	.36	1.0	1.0
		Max. Vert. Throw (ft)	—	22	—	26
		Max. Horiz. Throw (ft)	10	33	11	35
AA143-AL*-4	D4	Capacity (GPM)	.82	.82	2.3	2.3
		Max. Vert. Throw (ft)	—	27	—	32
		Max. Horiz. Throw (ft)	10	36	11	40
AA143-AL*-6	D6	Capacity (GPM)	1.7	1.8	4.9	5.1
		Max. Vert. Throw (ft)	—	33	—	38
		Max. Horiz. Throw (ft)	10	46	11	54
AA143-AL*-8	D8	Capacity (GPM)	2.8	3.3	8.1	9.4
		Max. Vert. Throw (ft)	—	35.5	—	42
		Max. Horiz. Throw (ft)	10	54	11	60
AA143-AL*-10	D10	Capacity (GPM)	3.9	4.9	11.2	13.9
		Max. Vert. Throw (ft)	—	37.5	—	44.5
		Max. Horiz. Throw (ft)	10.5	55	12	62

\*Inlet size ¾" or GH.

## AA18

Overall length 20", weight 1 pound, aluminum. ¼ NPT (F) inlet connection. Also available in brass.



### HOW TO ORDER

AA18-AL2

Aluminum

AA18-2

Brass

D 2

To order orifice disc only, specify orifice disc number.

GUNJET NUMBER	ORIFICE DISC NUMBER	PERFORMANCE	LIQUID PRESSURE IN PSI			
			100 PSI		800 PSI	
			A	C	A	C
AA18-AL2	D2	Capacity (GPM)	.45	.47	1.3	1.3
		Max. Vert. Throw (ft)	—	22	—	26
		Max. Horiz. Throw (ft)	10	33	11	35
AA18-AL4	D4	Capacity (GPM)	.92	.94	2.6	2.7
		Max. Vert. Throw (ft)	—	27	—	32
		Max. Horiz. Throw (ft)	10	36	11	40
AA18-AL6	D6	Capacity (GPM)	1.9	2.0	5.3	5.8
		Max. Vert. Throw (ft)	—	30	—	36
		Max. Horiz. Throw (ft)	10	45	11	50
AA18-AL8	D8	Capacity (GPM)	3.1	3.4	8.6	9.4
		Max. Vert. Throw (ft)	—	32	—	39
		Max. Horiz. Throw (ft)	10	46	11	51
AA18-AL10	D10	Capacity (GPM)	3.9	4.8	11.2	13.6
		Max. Vert. Throw (ft)	—	33	—	40
		Max. Horiz. Throw (ft)	10.5	49	12	54



## AA2

Overall length 24", weight 3.5 pounds, brass. 3/4" garden hose thread (F) inlet connection. Also available in aluminum as GunJet AA2-AL, weight 1.25 pounds.



## AA2A

Overall length 15", weight 2.5 pounds, brass. 3/4" garden hose thread (F) inlet connection. Also available in aluminum as GunJet AA2A-AL, weight 1 pound. Same design as GunJet AA2.



### HOW TO ORDER

**A A 2 - 2 0**

Brass

**A A 2 - A L 2 0**

Aluminum

**A Y - S S 2 0**

To order orifice disc only, specify orifice disc number.

GUNJET NUMBER	ORIFICE DISC NUMBER	PERFORMANCE	LIQUID PRESSURE IN PSI			
			100 PSI		800 PSI	
			A	C	A	C
AA2-20	AY-SS 20	Capacity (GPM)	.53	.90	1.5	2.5
		Max. Vert. Throw (ft)	—	25	—	33
		Max. Horiz. Throw (ft)	6	35	8	42
AA2-30	AY-SS 30	Capacity (GPM)	.79	1.4	2.2	4.0
		Max. Vert. Throw (ft)	—	27	—	34
		Max. Horiz. Throw (ft)	7	38	9	45
AA2-45	AY-SS 45	Capacity (GPM)	1.2	2.3	3.4	6.5
		Max. Vert. Throw (ft)	—	30	—	36
		Max. Horiz. Throw (ft)	8	41	9	48
AA2-60	AY-SS 60	Capacity (GPM)	1.6	3.6	4.5	10
		Max. Vert. Throw (ft)	—	32	—	40
		Max. Horiz. Throw (ft)	9	44	10	52
AA2-90	AY-SS 90	Capacity (GPM)	2.3	4.9	6.7	14
		Max. Vert. Throw (ft)	—	35	—	44
		Max. Horiz. Throw (ft)	10	47	12	57
AA2-120	AY-SS 120	Capacity (GPM)	3.2	6.4	9.0	17
		Max. Vert. Throw (ft)	—	37	—	48
		Max. Horiz. Throw (ft)	11	49	13	62
AA2-180	AY-SS 180	Capacity (GPM)	4.7	11	13	31
		Max. Vert. Throw (ft)	—	37	—	48
		Max. Horiz. Throw (ft)	12	49	14	62



# GunJet® SPRAY GUNS



## AA43 GUNJET

Designed and built for heavy-duty service. Stem extends through extension to valve seat located directly behind orifice disc for drip-free shutoff and instant operating response. Convenient trigger-lock for continuous spraying.

- Number AA43L for operating pressures up to 200 PSI.
- Number AA43H for operating pressures up to 800 PSI.
- Trigger handle control: All models have ½" NPT or BSPT (F) inlet connections.
- Exposed packing nut for easy adjustment of packing.
- Available in aluminum or brass.

## 43L & 43H

MODEL NUMBER	OPERATING PRESSURE RANGE (PSI)	MATERIAL	OVERALL LENGTH (INCHES)
AA(B)43L-AL	Up to 200	Aluminum	22
AA(B)43H-AL	200-800	Aluminum	

(B) = BSPT

## HARDENED STAINLESS STEEL TYPE D ORIFICE DISCS

Choose one of five interchangeable orifice disc capacities. Other sizes may be available upon request. Discs are corrosion and erosion-resistant.



## HARDENED STAINLESS STEEL TYPE DX-HSS SPRAY TIPS

For spraying trees and other applications where maximum spray throw is required.

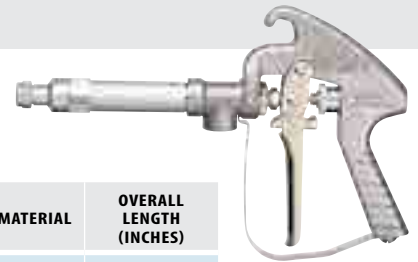

## 43A

MODEL NUMBER	OPERATING PRESSURE RANGE (PSI)	MATERIAL	OVERALL LENGTH (INCHES)
AA(B)43LA-AL	Up to 200	Aluminum	13
AA(B)43HA-AL	200-800	Aluminum	

(B) = BSPT

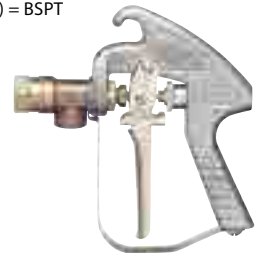

Types 43LC-1/2 and 43HC-1/2 have ½" NPT (F) outlet connections. Inlet connections are ½" NPT or BSPT (F).

## 43LC-1/2 & 43HC-1/2

MODEL NUMBER	OPERATING PRESSURE RANGE (PSI)	MATERIAL	OVERALL LENGTH (INCHES)
AA(B)43LC-1/2	Up to 200	Brass	8
AA(B)43HC-1/2	200-800	Brass	

(B) = BSPT

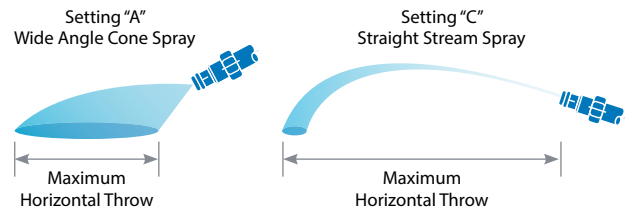

As trigger is drawn back, valve moves from shutoff position to initial wide angle spray, to continuously narrower cone sprays, to final straight stream. Knurled ring behind trigger is adjustable to stop trigger at any desired position.

## HOW TO ORDER

AA(B)43L-AL4 (Aluminum)

Specify complete GunJet spray gun number and material.

GUNJET NUMBER	ORIFICE DISC NUMBER	PERFORMANCE	LIQUID PRESSURE IN PSI									
			40 PSI		100 PSI		200 PSI		400 PSI		800 PSI	
			A	C	A	C	A	C	A	C	A	C
AA(B)43L-AL2 AA(B)43H-AL2	D2	Capacity (GPM)	.29	.30	.45	.47	.64	.66	.90	.94	1.3	1.3
		Max. Vert. Throw (ft)	—	22	—	22	—	23	—	24	—	26
		Max. Horiz. Throw (ft)	10	32	10	33	10	34	10.5	35	11	35
AA(B)43L-AL4 AA(B)43H-AL4	D4	Capacity (GPM)	.60	.61	.92	.94	1.3	1.3	1.8	1.9	2.6	2.7
		Max. Vert. Throw (ft)	—	26	—	27	—	28	—	30	—	32
		Max. Horiz. Throw (ft)	10	36	10	36	10.5	37	11	39	11	40
AA(B)43L-AL6 AA(B)43H-AL6	D6	Capacity (GPM)	1.2	1.3	1.9	2.0	2.7	2.9	3.8	4.1	5.3	5.8
		Max. Vert. Throw (ft)	—	31.5	—	33	—	34.5	—	36.5	—	38
		Max. Horiz. Throw (ft)	10	44	10	45	10.5	46	11	48	11	50
AA(B)43L-AL8 AA(B)43H-AL8	D8	Capacity (GPM)	2.0	2.5	3.1	3.4	4.4	4.8	6.2	6.8	8.8	9.6
		Max. Vert. Throw (ft)	—	33	—	35.5	—	38	—	40.5	—	42
		Max. Horiz. Throw (ft)	10	45	10	46	10.5	47	11	49	11	51
AA(B)43L-AL10 AA(B)43H-AL10	D10	Capacity (GPM)	2.6	3.2	4.1	5.0	5.8	7.1	8.2	10	10.2	14.1
		Max. Vert. Throw (ft)	—	35	—	37.5	—	40	—	42.5	—	44.5
		Max. Horiz. Throw (ft)	10	46	10.5	49	11	50	11.5	52	12	54

(B) = BSPT

## 25660

- Interchangeable nozzle tips are color-coded for easy identification of nozzle tip size.
- Nozzle tips provide a 45° full cone "showerhead" spray pattern.
- Convenient trigger lock for continuous spraying.
- Options available: hose shank swivel for inlet connection and extension wand and adapters for low-volume and spot spraying.
- Maximum operating pressure of 200 PSI.
- Made of Nylon with FKM O-rings and stainless steel springs.



MODEL NUMBER	NOZZLE TIP NUMBER	CAPACITY (GPM) AT VARIOUS PRESSURE*						
		2 PSI	4 PSI	6 PSI	8 PSI	10 PSI	15 PSI	20 PSI
25660-1.5	CP25670-1.5-NY	1.4	1.9	2.3	2.6	2.9	3.4	4.0
25660-3.0	CP25670-3.0-NYB	2.0	2.7	3.2	3.6	4.1	4.9	5.6
25660-4.0	CP25670-4.0-NY	2.3	3.1	3.7	4.3	4.7	5.6	6.4

\*Pressure measured at spray nozzle. For gun without spray tip, order 25660-0.

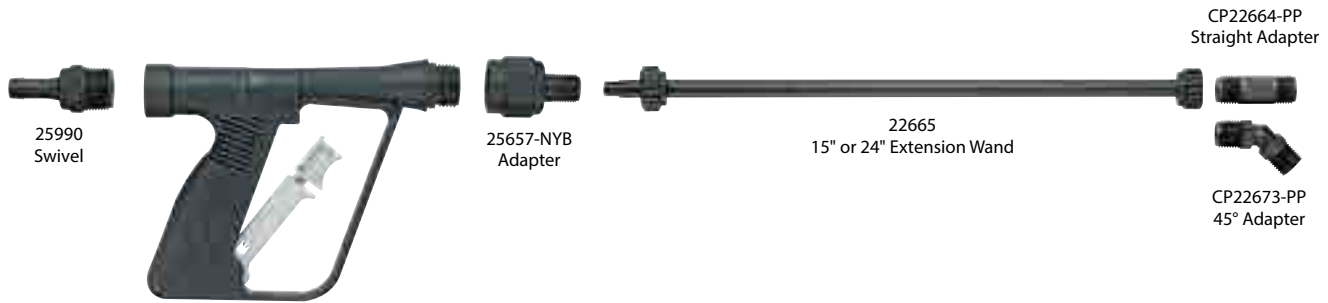

## 25990 SWIVEL

Allows operator to concentrate on application without hose interference. 3/4" (M) NPT connection with 1/2" hose shank. Maximum pressure 150 PSI.

## 25657-NYB ADAPTER

Replaces shower nozzle to allow extension wand or standard TeeJet tip to be attached directly to lawn spray gun. 3/4" (F) GHT inlet with 1/16"-16 TeeJet thread outlet. Maximum pressure 150 PSI. See page 177 for adjustable ConeJet® nozzles.

## 22665 EXTENSION WAND

For low volume and spot spraying applications. Available in both 15" and 24" lengths, the extension fits on 25657-NYB adapter. Maximum pressure 150 PSI.

## CP22673-PP & CP22664-PP ADAPTERS

Used for attaching standard TeeJet tips or adjustable ConeJet nozzles. See page 177 for adjustable ConeJet nozzles.

## PW4000A

The model PW4000A GunJet is a durable high-pressure spray gun that offers comfort and control. Trigger locks into an off position to prevent accidental discharge. The PW4000A operates at up to 4,000 PSI and provides flow rates up to 10 GPM. Liquid temperatures up to 300°F. Available with 1/4" or 3/8" NPT or BSPT inlet and outlet connections.



## AA30A

Maximum pressure rating of 1,500 PSI with 5 GPM up to 200°F and 1/4" (F) NPT or BSPT inlet thread. Materials including Nylon handles and trigger guards, forged brass valve bodies, Buna-N or FKM stem seals, PTFE valve seats and stainless steel working parts mean long, productive equipment life.

### HOW TO ORDER

AA(B)30A - 1 / 4

(B)=BSPT

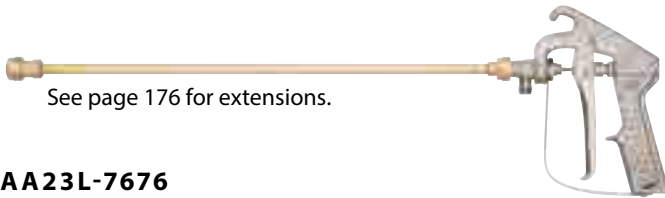

See page 176 for extensions.

## AA23L-7676

The AA23L-7676 GunJet spray gun (shown above) is also available without extension as GunJet spray gun AA23L. Flow rates up to 5 GPM. Maximum operating pressure of 250 PSI. Inlet 1/4" NPS (M) thread. Strong aluminum alloy body. When used with extension, the valve stem extends through the entire extension length for drip-free shutoff immediately behind the spray tip. Accommodates all interchangeable TeeJet spray tips.

GUNJET NUMBER	EXTENSION LENGTH (IN)
AA23L	Without Extension
AA23L-7676-8	8
AA23L-7676-18	18
AA23L-7676-24	24
AA23L-7676-36	36
AA23L-7676-48	48

### HOW TO ORDER

AA23L



### HOW TO ORDER

(B)PW4000A

3/8" inlet and 1/4" outlet

(B)PW4000A - 1 / 4 x 1 / 4

1/4" inlet and outlet

(B)PW4000A - 3 / 8 x 3 / 8

3/8" inlet and outlet

(B)=BSPT

## AA30L-PP

This version of the standard AA30L GunJet spray gun is constructed of polypropylene for excellent corrosion resistance. The maximum pressure rating is 150 PSI with flow rates up to 5 GPM. Liquid inlet connection available in 1/4" (F) NPT or BSPT. Wetted parts are polypropylene, stainless steel and FKM.



### HOW TO ORDER

AA(B)30L - P P

(B)=BSPT



## AA30L-22425

The AA30L-22425 GunJet spray gun (shown above) is also available without extension as GunJet spray gun AA30L. Flow rates up to 5 GPM. Maximum operating pressure of 250 PSI. Outlet connection is 1/16"-16 TeeJet thread. Body and trigger molded of tough Nylon. When used with extension, the valve stem extends through the entire extension length for drip-free shutoff immediately behind the spray tip. Accommodates all interchangeable TeeJet spray tips.

GUNJET NUMBER	EXTENSION LENGTH (IN)
AA(B)30L-1/4	Without Extension
AA(B)30L-22425-8	8
AA(B)30L-22425-18	18
AA(B)30L-22425-24	24
AA(B)30L-22425-36	36
AA(B)30L-22425-48	48

### HOW TO ORDER

AA(B)30L - 1 / 4



(B)=BSPT



## 50800

The 50800 TriggerJet spray gun is a lightweight spray gun designed for use with backpack, canister or other low-pressure sprayers. The TriggerJet is made of molded polypropylene for excellent chemical resistance and durability.

- Available with 15" polypropylene or 21" aluminum extension wand.
- Available with 38720-PPB-X18 or X26 adjustable ConeJet® tips with a 30° offset.
- Trigger lock permits locking gun in an open position for continuous flow.
- Maximum operating pressure of 100 PSI.
- ¼" or ⅜" hose shank connection.
- Approximate max. hose O.D. – ½".
- Polypropylene strainer located inside handle to prevent tip clogging.

MODEL NUMBER	DESCRIPTION	INLET CONNECTION	TIP NUMBER
50800-15-PP-300	15" Polypropylene Extension	¼" Hose Barb Inlet	 38720-PPB-X18
50800-15-PP-406		⅜" Hose Barb Inlet	
50800-21-AL-300	21" Aluminum Extension	¼" Hose Barb Inlet	38720-PPB-X26
50800-21-AL-406		⅜" Hose Barb Inlet	
50800-15-PP-300-X26	15" Polypropylene Extension	¼" Hose Barb Inlet	 38720-PPB-X26
50800-15-PP-406-X26		⅜" Hose Barb Inlet	
50800-21-AL-300-X26	21" Aluminum Extension	¼" Hose Barb Inlet	38720-PPB-X26
50800-21-AL-406-X26		⅜" Hose Barb Inlet	
CP50786-PP-300	Replacement Inlet Fitting	¼" Hose Barb Inlet	38720-PPB-X26
CP50786-PP-406		⅜" Hose Barb Inlet	



## 50800 TRIGGERJET LESS EXTENSION & TIP

- Can be fitted with any standard TeeJet tip.

MODEL NUMBER	DESCRIPTION	INLET CONNECTION
50800-PP-300	TriggerJet, Less Extension	¼" Hose Barb Inlet
50800-PP-406	TriggerJet, Less Extension	⅜" Hose Barb Inlet



## 22670

The 22670 TriggerJet spray gun kit combines the 22650 TriggerJet spray gun with an extension wand, adapter, and adjustable ConeJet spray tip. Maximum pressure rating is 150 PSI.

- 22650 TriggerJet spray gun with choice of 1/4" or 3/8" hose shank and a 1/4" NPT or BSPT (F) thread inlet connection.

- Trigger lock permits locking gun in an open position for continuous flow (optional).
- 22665 extension wand with choice of 15" or 24" lengths.

- 38720-PPB-X8 adjustable ConeJet® spray tip with Viton® O-ring.
- Accepts all standard TeeJet spray tips and tip strainers.

### HOW TO ORDER

(B) 22670-PP-15-1/4

Reference page 177 for additional spray tip information.

MODEL NUMBER	EXTENSION LENGTH	INLET CONNECTION	TIP NUMBER
(B)22670-PP-15-1/4	15"	1/4" (F)	 <b>38720-PPB-X8</b> (Standard tip shipped with TriggerJet)
22670-PP-15-300	15"	1/4" Hose Shank	
22670-PP-15-406	15"	3/8" Hose Shank	
(B)22670-PP-24-1/4	24"	1/4" (F)	
22670-PP-24-300	24"	1/4" Hose Shank	
22670-PP-24-406	24"	3/8" Hose Shank	

(B)=BSPT

## 22650

The 22650 TriggerJet spray gun is a lightweight spray gun designed for use with backpack, canister or other low-pressure sprayers. The TriggerJet is made of molded polypropylene for excellent chemical resistance and durability.

- Choice of 1/4" or 3/8" hose shank and 1/4" NPT or BSPT (F) thread inlet connection.

- Replaceable diaphragm made of FKM.
- Trigger lock permits locking gun in an open position for continuous flow (optional).
- Maximum operating pressure of 150 PSI.
- Accepts all standard TeeJet spray tips and tip strainers.



### HOW TO ORDER

(B) 22650-PP-1/4

Reference page 177 for additional spray tip information.

MODEL NUMBER	EXTENSION LENGTH	INLET CONNECTION	TIP NUMBER
(B)22650-PP-1/4	None	1/4" (F)	None
22650-PP-300		1/4" Hose Shank	
22650-PP-406		3/8" Hose Shank	

(B)=BSPT



# ConeJet® ADJUSTABLE SPRAY TIPS

## 38720-PP

- Provides adjustable spray from solid stream to a hollow cone pattern.
- Made of polypropylene material for excellent chemical resistance.
- Fits any 1/16"–16 TeeJet® male thread bodies.
- 30° offset from horizontal incorporated into main tip body.



ADJUSTABLE CONEJET TIP NUMBER	PERFORMANCE	LIQUID PRESSURE IN PSI									
		20 PSI		30 PSI		40 PSI		60 PSI		100 PSI	
		SETTING		SETTING		SETTING		SETTING		SETTING	
		A	B	A	B	A	B	A	B	A	B
38720-PPB-X8	Capacity (GPM)	0.097	0.33	0.12	0.40	0.13	0.47	0.16	0.57	0.21	0.74
	Spray Angle	66°	—	71°	—	74°	—	77°	—	80°	—
	Max. Throw (ft)	3	34	3	37	3	38	3	38	4	38
38720-PPB-X12	Capacity (GPM)	0.15	0.49	0.18	0.60	0.20	0.69	0.24	0.84	0.31	1.1
	Spray Angle	71°	—	75°	—	77°	—	78°	—	80°	—
	Max. Throw (ft)	3.5	36	4	39	4	40	4	41	4	41
38720-PPB-X18	Capacity (GPM)	0.20	0.68	0.24	0.81	0.28	0.92	0.34	1.1	0.42	1.4
	Spray Angle	61°	—	68°	—	80°	—	80°	—	80°	—
	Max. Throw (ft)	4	38	4	41	4	42	4	42	6	42
38720-PPB-X26	Capacity (GPM)	0.31	0.89	0.38	1.1	0.43	1.2	0.53	1.5	0.68	1.9
	Spray Angle	77°	—	82°	—	84°	—	86°	—	86°	—
	Max. Throw (ft)	4	34	4.5	37	5	38	5.5	39	6	40

## 5500

Knurled body of tip rotates through a half turn to provide spray selection from wide angle, finely atomized cone spray to a straight stream spray. Tip settings "A" and "B" represent two extreme points of rotation in tip adjustment. Other sizes available.



## 5500-PP

The 5500 adjustable ConeJet® tip is also available in a polypropylene version. The polypropylene tip has the same performance characteristics as the brass tip and provides excellent chemical resistance. This tip's light weight makes it well-suited for use on handheld and backpack type sprayers.

O-Ring: EPDM is standard, FKM is optional.

Tip Setting "A"  
Cone Spray Pattern

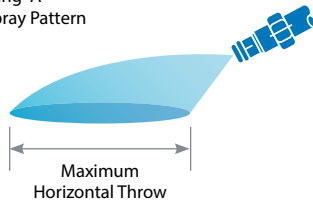

Tip Setting "B"  
Straight Stream Spray Pattern

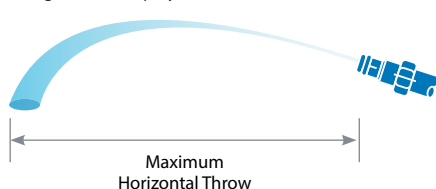

ADJUSTABLE CONEJET TIP NUMBER	PERFORMANCE	LIQUID PRESSURE IN PSI											
		20 PSI		30 PSI		40 PSI		60 PSI		100 PSI		150 PSI	
		SETTING		SETTING		SETTING		SETTING		SETTING		SETTING	
		A	B	A	B	A	B	A	B	A	B	A	B
5500-X1	Capacity (GPM)	—	.049	.015	.061	.017	.07	.02	.086	.025	.11	.028	.14
	Spray Angle	—	—	38°	—	54°	—	71°	—	80°	—	83°	—
	Max. Throw (ft)	—	19	1	22	1.5	24	1.5	26	1.5	26	1.5	26
5500-X2	Capacity (GPM)	.025	.091	.03	.11	.033	.13	.04	.16	.05	.20	.058	.25
	Spray Angle	40°	—	60°	—	68°	—	75°	—	80°	—	83°	—
	Max. Throw (ft)	1.5	23	1.5	26	2	27	2	28	2	28	2	28
5500-X3	Capacity (GPM)	.037	.13	.045	.17	.05	.19	.058	.23	.073	.30	.088	.37
	Spray Angle	57°	—	68°	—	72°	—	76°	—	80°	—	82°	—
	Max. Throw (ft)	2	27	2	30	2	31	2	31	3	31	3	31
5500-X4	Capacity (GPM)	.05	.18	.058	.22	.067	.25	.08	.31	.10	.40	.12	.49
	Spray Angle	61°	—	70°	—	73°	—	77°	—	80°	—	81°	—
	Max. Throw (ft)	2.5	30	2.5	33	3	34	3	34	3	34	3	34
5500-X5	Capacity (GPM)	.061	.21	.076	.26	.082	.30	.10	.37	.13	.48	.15	.58
	Spray Angle	61°	—	70°	—	74°	—	77°	—	80°	—	81°	—
	Max. Throw (ft)	2.5	31	2.5	34	3	35	3	35	3	35	3	35
5500-X6	Capacity (GPM)	.073	.26	.087	.32	.10	.37	.12	.45	.15	.58	.19	.71
	Spray Angle	65°	—	71°	—	74°	—	77°	—	80°	—	80°	—
	Max. Throw (ft)	2.5	32	3	35	3	36	3.5	36	3.5	36	3.4	36
5500-X8	Capacity (GPM)	.097	.33	.12	.40	.13	.47	.16	.57	.21	.74	.25	.90
	Spray Angle	66°	—	71°	—	74°	—	77°	—	80°	—	80°	—
	Max. Throw (ft)	3	34	3	37	3	38	3	38	4	38	4	38
5500-X10	Capacity (GPM)	.12	.42	.15	.52	.17	.60	.21	.73	.26	.94	.31	1.2
	Spray Angle	68°	—	72°	—	75°	—	78°	—	80°	—	80°	—
	Max. Throw (ft)	3	35	3.5	38	3.5	39	4	40	4	40	4	40
5500-X12	Capacity (GPM)	.15	.49	.18	.60	.20	.69	.24	.84	.31	1.1	.38	1.3
	Spray Angle	69°	—	73°	—	76°	—	78°	—	80°	—	80°	—
	Max. Throw (ft)	3.5	36	4	39	4	40	4	41	4	41	4	41
5500-X14	Capacity (GPM)	.17	.55	.20	.67	.23	.78	.29	.95	.37	1.2	.45	1.5
	Spray Angle	70°	—	74°	—	76°	—	78°	—	80°	—	80°	—
	Max. Throw (ft)	3.5	37	4	40	4	41	4	41	4.5	41	4.5	41
5500-X18	Capacity (GPM)	.21	.69	.26	.84	.30	.97	.37	1.2	.47	1.5	.58	1.9
	Spray Angle	71°	—	75°	—	77°	—	78°	—	80°	—	79°	—
	Max. Throw (ft)	4	38	4	41	4	42	4	42	5	42	5	42
5500-X22	Capacity (GPM)	.26	.83	.32	1.0	.37	1.2	.45	1.4	.58	1.9	.70	2.3
	Spray Angle	71°	—	75°	—	78°	—	79°	—	80°	—	78°	—
	Max. Throw (ft)	4	39	4.5	41	5	42	5	42	5	42	5	42
5500-X26	Capacity (GPM)	.31	.98	.37	1.2	.43	1.4	.53	1.7	.68	2.2	.83	2.7
	Spray Angle	72°	—	76°	—	78°	—	79°	—	80°	—	78°	—
	Max. Throw (ft)	4.5	40	5	42	5	43	5.5	43	5.5	43	5.5	43

Above data is based on spraying water from a height of about 2.5' with tip tilted about as shown at left for each setting.

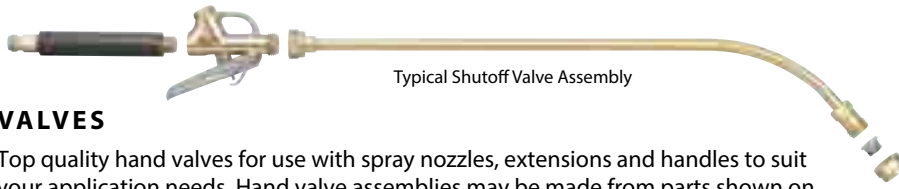

Typical Shutoff Valve Assembly

## VALVES

Top quality hand valves for use with spray nozzles, extensions and handles to suit your application needs. Hand valve assemblies may be made from parts shown on this page. The "typical assembly" shown above includes 4727 handle, 4688 valve, 6671-18 curved extension with swivel body, TeeJet cap and flat spray tip.

### AA31

For pressures up to 500 PSI. Comfortable palm fitting gun. For use with any TeeJet spray tip. 1/4" NPS (M) inlet connection.



Forged brass body and nickel-plated steel trigger. PTFE valve seat and packing, stainless steel valve stem. Also supplied as 31-1/4F with 1/4" NPT (F) inlet connection.

### AA36 TRIGGER VALVE WITH TRIGGER LOCK

Choice of 1/4" NPT (F) inlet and outlet, or 3/8" NPT (F) inlet and outlet. Max pressure of 150 PSI. Brass or stainless steel material.



### 6104 TRIGGER VALVE WITH TRIGGER LOCK

Same as 4688 except with 1/4" NPT (F) inlet and outlet connections. Brass material.



### 6466 TRIGGER VALVE

Same as 4688, less trigger lock, with extra long trigger. Brass material.



### 4688 TRIGGER VALVE WITH TRIGGER LOCK

Max flow rate 2 GPM, max pressure of 250 PSI. 1/4" NPT (F) inlet connection, 1/4"-16 (M) outlet connection. Brass material.



### 6590 TRIGGER VALVE

Same as 6104, less trigger lock, with extra long trigger. Brass material.



### 13212 ADAPTER

3/8" NPT (M) outlet, 3/4" garden hose thread inlet for use with 3/8" 36 valve. Brass material.



## VALVE HANDLES

(Choice of valve handles for above valves.)

Outlet connections are 1/4" NPT (M) to fit 1/4" NPT (F) inlets of all valves shown.



### (B)4727 SURE GRIP HANDLE

Brass, rubber-covered, 1/4" NPS (M) inlet connection.



### 4754 SURE GRIP HANDLE

Brass, rubber-covered, 3/4" garden hose thread (F) inlet connection.

## EXTENSIONS

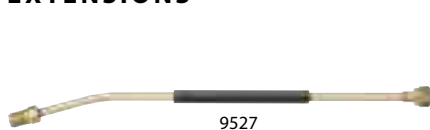

9527



4673

7715

### HIGH-PRESSURE CURVED EXTENSIONS

9527 for pressures to 1,000 PSI. Fits models 23H and 31 GunJet spray guns.

### STRAIGHT & CURVED EXTENSIONS

4673 and 6671 are for pressures to 125 PSI. 7715 is for pressures to 250 PSI. Fits models 23L and 31 GunJet spray guns and trigger valves. CP4743-TEF inlet gasket for use with 4673, 6671, and 7715 extensions.

### TRIGGERJET® EXTENSION

22665-PP is for use with 22650-PP TriggerJet spray gun. Maximum pressure rating of 150 PSI. Available in 15" and 24" lengths.

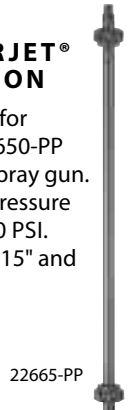

22665-PP

EXTENSION TYPE & NUMBER	EXTENSION LENGTH (IN.)
9527-8	8
9527-18	18
9527-24	24
9527-36	36
9527-48	48

STRAIGHT WITH FIXED BODY	CURVED WITH SWIVEL BODY	CURVED WITH FIXED BODY	EXTENSION LENGTH (IN.)
7715-8	4673-8	6671-8	8
7715-18	4673-18	6671-18	18
7715-24	4673-24	6671-24	24
7715-30	4673-30	6671-30	30
7715-36	4673-36	6671-36	36
7715-48	4673-48	6671-48	48



# UNIVERSAL APPLICATION RATE CHART FOR 10" TIP SPACING

TIP CAPACITY	LIQUID PRESSURE IN PSI	CAPACITY ONE TIP IN GPM	CAPACITY ONE TIP IN OZ/MIN	GALLONS PER ACRE – 10" SPRAY TIP SPACING											
				4 MPH	5 MPH	6 MPH	7 MPH	8 MPH	10 MPH	12 MPH	14 MPH	16 MPH	18 MPH	20 MPH	22 MPH
01	15	0.061	7.8	9.1	7.2	6.0	5.2	4.5	3.6	3.0	2.6	2.3	2.0	1.8	1.6
	20	0.071	9.1	10.5	8.4	7.0	6.0	5.3	4.2	3.5	3.0	2.6	2.3	2.1	1.9
	30	0.087	11	12.9	10.3	8.6	7.4	6.5	5.2	4.3	3.7	3.2	2.9	2.6	2.3
	40	0.10	13	14.9	11.9	9.9	8.5	7.4	5.9	5.0	4.2	3.7	3.3	3.0	2.7
	50	0.11	14	16.3	13.1	10.9	9.3	8.2	6.5	5.4	4.7	4.1	3.6	3.3	3.0
	60	0.12	15	17.8	14.3	11.9	10.2	8.9	7.1	5.9	5.1	4.4	4.0	3.6	3.2
	75	0.14	18	21	16.6	13.9	11.9	10.4	8.3	6.9	5.9	5.2	4.6	4.2	3.8
90	0.15	19	22	17.8	14.9	12.7	11.1	8.9	7.4	6.4	5.6	5.0	4.5	4.1	
015	15	0.092	12	13.7	10.9	9.1	7.8	6.8	5.5	4.6	3.9	3.4	3.0	2.7	2.5
	20	0.11	14	16.3	13.1	10.9	9.3	8.2	6.5	5.4	4.7	4.1	3.6	3.3	3.0
	30	0.13	17	19.3	15.4	12.9	11.0	9.7	7.7	6.4	5.5	4.8	4.3	3.9	3.5
	40	0.15	19	22	17.8	14.9	12.7	11.1	8.9	7.4	6.4	5.6	5.0	4.5	4.1
	50	0.17	22	25	20	16.8	14.4	12.6	10.1	8.4	7.2	6.3	5.6	5.0	4.6
	60	0.18	23	27	21	17.8	15.3	13.4	10.7	8.9	7.6	6.7	5.9	5.3	4.9
	75	0.21	27	31	25	21	17.8	15.6	12.5	10.4	8.9	7.8	6.9	6.2	5.7
90	0.23	29	34	27	23	19.5	17.1	13.7	11.4	9.8	8.5	7.6	6.8	6.2	
02	15	0.12	15	17.8	14.3	11.9	10.2	8.9	7.1	5.9	5.1	4.5	4.0	3.6	3.2
	20	0.14	18	21	16.6	13.9	11.9	10.4	8.3	6.9	5.9	5.2	4.6	4.2	3.8
	30	0.17	22	25	20	16.8	14.4	12.6	10.1	8.4	7.2	6.3	5.6	5.0	4.6
	40	0.20	26	30	24	19.8	17.0	14.9	11.9	9.9	8.5	7.4	6.6	5.9	5.4
	50	0.22	28	33	26	22	18.7	16.3	13.1	10.9	9.3	8.2	7.3	6.5	5.9
	60	0.24	31	36	29	24	20	17.8	14.3	11.9	10.2	8.9	7.9	7.1	6.5
	75	0.27	35	40	33	27	23	20	16.0	13.4	11.5	10.0	8.9	8.0	7.3
90	0.30	38	45	36	30	25	22	17.8	14.9	12.7	11.1	9.9	8.9	8.1	
025	15	0.15	19	22	17.8	14.9	12.7	11.1	8.9	7.4	6.4	5.6	5.0	4.5	4.1
	20	0.18	23	27	21	17.8	15.3	13.4	10.7	8.9	7.6	6.7	5.9	5.3	4.9
	30	0.22	28	33	26	22	18.7	16.3	13.1	10.9	9.3	8.2	7.3	6.5	5.9
	40	0.25	32	37	30	25	21	18.6	14.9	12.4	10.6	9.3	8.3	7.4	6.8
	50	0.28	36	42	33	28	24	21	16.6	13.9	11.9	10.4	9.2	8.3	7.6
	60	0.31	40	46	37	31	26	23	18.4	15.3	13.2	11.5	10.2	9.2	8.4
	75	0.34	44	50	40	34	29	25	20	16.8	14.4	12.6	11.2	10.1	9.2
90	0.38	49	56	45	38	32	28	23	18.8	16.1	14.1	12.5	11.3	10.3	
03	15	0.18	23	27	21	17.8	15.3	13.4	10.7	8.9	7.6	6.7	5.9	5.3	4.9
	20	0.21	27	31	25	21	17.8	15.6	12.5	10.4	8.9	7.8	6.9	6.2	5.7
	30	0.26	33	39	31	26	22	19.3	15.4	12.9	11.0	9.7	8.6	7.7	7.0
	40	0.30	38	45	36	30	25	22	17.8	14.9	12.7	11.1	9.9	8.9	8.1
	50	0.34	44	50	40	34	29	25	20	16.8	14.4	12.6	11.2	10.1	9.2
	60	0.37	47	55	44	37	31	27	22	18.3	15.7	13.7	12.2	11.0	10.0
	75	0.41	52	61	49	41	35	30	24	20	17.4	15.2	13.5	12.2	11.1
90	0.45	58	67	53	45	38	33	27	22	19.1	16.7	14.9	13.4	12.2	
035	15	0.21	27	31	25	21	17.8	15.6	12.5	10.4	8.9	7.8	6.9	6.2	5.7
	20	0.25	32	37	30	25	21	18.6	14.9	12.4	10.6	9.3	8.3	7.4	6.8
	30	0.30	38	45	36	30	25	22	17.8	14.9	12.7	11.1	9.9	8.9	8.1
	40	0.35	45	52	42	35	30	26	21	17.3	14.9	13.0	11.6	10.4	9.5
	50	0.39	50	58	46	39	33	29	23	19.3	16.5	14.5	12.9	11.6	10.5
	60	0.43	55	64	51	43	36	32	26	21	18.2	16.0	14.2	12.8	11.6
	75	0.48	61	71	57	48	41	36	29	24	20	17.8	15.8	14.3	13.0
90	0.53	68	79	63	52	45	39	31	26	22	19.7	17.5	15.7	14.3	
04	15	0.24	31	36	29	24	20	17.8	14.3	11.9	10.2	8.9	7.9	7.1	6.5
	20	0.28	36	42	33	28	24	21	16.6	13.9	11.9	10.4	9.2	8.3	7.6
	30	0.35	45	52	42	35	30	26	21	17.3	14.9	13.0	11.6	10.4	9.5
	40	0.40	51	59	48	40	34	30	24	19.8	17.0	14.9	13.2	11.9	10.8
	50	0.45	58	67	53	45	38	33	27	22	19.1	16.7	14.9	13.4	12.2
	60	0.49	63	73	58	49	42	36	29	24	21	18.2	16.2	14.6	13.2
	75	0.55	70	82	65	54	47	41	33	27	23	20	18.2	16.3	14.9
90	0.60	77	89	71	59	51	45	36	30	25	22	19.8	17.8	16.2	
05	15	0.31	40	46	37	31	26	23	18.4	15.3	13.2	11.5	10.2	9.2	8.4
	20	0.35	45	52	42	35	30	26	21	17.3	14.9	13.0	11.6	10.4	9.5
	30	0.43	55	64	51	43	36	32	26	21	18.2	16.0	14.2	12.8	11.6
	40	0.50	64	74	59	50	42	37	30	25	21	18.6	16.5	14.9	13.5
	50	0.56	72	83	67	55	48	42	33	28	24	21	18.5	16.6	15.1
	60	0.61	78	91	72	60	52	45	36	30	26	23	20	18.1	16.5
	75	0.68	87	101	81	67	58	50	40	34	29	25	22	20	18.4
90	0.75	96	111	89	74	64	56	45	37	32	28	25	22	20	
06	15	0.37	47	55	44	37	31	27	22	18.3	15.7	13.7	12.2	11.0	10.0
	20	0.42	54	62	50	42	36	31	25	21	17.8	15.6	13.9	12.5	11.3
	30	0.52	67	77	62	51	44	39	31	26	22	19.3	17.2	15.4	14.0
	40	0.60	77	89	71	59	51	45	36	30	25	22	19.8	17.8	16.2
	50	0.67	86	99	80	66	57	50	40	33	28	25	22	19.9	18.1
	60	0.73	93	108	87	72	62	54	43	36	31	27	24	22	19.7
	75	0.82	105	122	97	81	70	61	49	41	35	30	27	24	22
90	0.90	115	134	107	89	76	67	53	45	38	33	30	27	24	
08	15	0.49	63	73	58	49	42	36	29	24	21	18.2	16.2	14.6	13.2
	20	0.57	73	85	68	56	48	42	34	28	24	21	18.8	16.9	15.4
	30	0.69	88	102	82	68	59	51	41	34	29	26	23	20	18.6
	40	0.80	102	119	95	79	68	59	48	40	34	30	26	24	22
	50	0.89	114	132	106	88	76	66	53	44	38	33	29	26	24
	60	0.98	125	146	116	97	83	73	58	49	42	36	32	29	26
	75	1.10	141	163	131	109	93	82	65	54	47	41	36	33	30
90	1.20	154	178	143	119	102	89	71	59	51	45	40	36	32	
10	15	0.61	78	91	72	60	52	45	36	30	26	23	20	18.1	16.5
	20	0.71	91	105	84	70	60	53	42	35	30	26	23	21	19.2
	30	0.87	111	129	103	86	74	65	52	43	37	32	29	26	23
	40	1.00	128	149	119	99	85	74	59	50	42	37	33	30	27
	50	1.12	143	166	133	111	95	83	67	55	48	42	37	33	30
	60	1.22	156	181	145	121	104	91	72	60	52	45	40	36	33
	75	1.37	175	203	163	136	116	102	81	68	58	51	45	41	37
90	1.50	192	223	178	149	127	111	89	74	64	56	50	45	41	
12	15	0.73	93	108	87	72	62	54	43	36	31	27	24	22	19.7
	20	0.85	109	126	101	84	72	63	50	42	36	32	28	25	23
	30	1.04	133	154	124	103	88	77	62	51	44	39	34	31	28
	40	1.20	154	178	143	119	102	89	71	59	51	45	40	36	32
	50	1.34	172	199	159	133	114	99	80	66	57	50	44	40	36
	60	1.47	188	218	175	146	125	109	87	73	62	55	49	44	40
	75	1.64	210	244	195	162	139	122	97	81	70	61	54	49	44
90	1.80	230	267	214	178	153	134	107	89	76	67	59	53	49	
15	15	0.92	118	137	109	91	78	68	55	46	39	34	30	27	25
	20	1.06	136	157	126	105	90	79	63	52	45	39	35	31	29
	30	1.30													



# UNIVERSAL APPLICATION RATE CHART FOR 15" TIP SPACING

TIP CAPACITY	LIQUID PRESSURE IN PSI	CAPACITY ONE TIP IN GPM	CAPACITY ONE TIP IN OZ/MIN	GALLONS PER ACRE – 15" SPRAY TIP SPACING											
				4 MPH	5 MPH	6 MPH	7 MPH	8 MPH	10 MPH	12 MPH	14 MPH	16 MPH	18 MPH	20 MPH	22 MPH
01	15	0.061	7.8	6.0	4.8	4.0	3.5	3.0	2.4	2.0	1.7	1.5	1.3	1.2	1.1
	20	0.071	9.1	7.0	5.6	4.7	4.0	3.5	2.8	2.3	2.0	1.8	1.6	1.4	1.3
	30	0.087	11	8.6	6.9	5.7	4.9	4.3	3.4	2.9	2.5	2.2	1.9	1.7	1.6
	40	0.10	13	10.9	7.9	6.6	5.7	5.0	4.0	3.3	2.8	2.5	2.2	2.0	1.8
	50	0.11	14	11.9	8.7	7.3	6.2	5.4	4.4	3.6	3.1	2.7	2.4	2.2	2.0
	60	0.12	15	12.9	9.5	7.9	6.8	5.9	4.8	4.0	3.4	3.0	2.6	2.4	2.2
75	0.14	18	15.9	11.1	9.2	7.9	6.9	5.5	4.6	4.0	3.5	3.1	2.8	2.5	
90	0.15	19	16.9	11.9	9.9	8.5	7.4	5.9	5.0	4.2	3.7	3.3	3.0	2.7	
015	15	0.092	12	9.1	7.3	6.1	5.2	4.6	3.6	3.0	2.6	2.3	2.0	1.8	1.7
	20	0.11	14	10.9	8.7	7.3	6.2	5.4	4.4	3.6	3.1	2.7	2.4	2.2	2.0
	30	0.13	17	12.9	10.3	8.6	7.4	6.4	5.1	4.3	3.7	3.2	2.9	2.6	2.3
	40	0.15	19	14.9	11.9	9.9	8.5	7.4	5.9	5.0	4.2	3.7	3.3	3.0	2.7
	50	0.17	22	16.8	13.5	11.2	9.6	8.4	6.7	5.6	4.8	4.2	3.7	3.4	3.1
	60	0.18	23	17.8	14.3	11.9	10.2	8.9	7.1	5.9	5.1	4.5	4.0	3.6	3.2
75	0.21	27	21	16.6	13.9	11.9	10.4	8.3	6.9	5.9	5.2	4.6	4.2	3.8	
90	0.23	29	23	18.2	15.2	13.0	11.4	9.1	7.6	6.5	5.7	5.1	4.6	4.1	
02	15	0.12	15	11.9	9.5	7.9	6.8	5.9	4.8	4.0	3.4	3.0	2.6	2.4	2.2
	20	0.14	18	13.9	11.1	9.2	7.9	6.9	5.5	4.6	4.0	3.5	3.1	2.8	2.5
	30	0.17	22	16.8	13.5	11.2	9.6	8.4	6.7	5.6	4.8	4.2	3.7	3.4	3.1
	40	0.19	26	19.8	15.8	13.2	11.3	9.9	7.9	6.6	5.7	5.0	4.4	4.0	3.6
	50	0.22	28	22	17.4	14.5	12.4	10.9	8.7	7.3	6.2	5.4	4.8	4.4	4.0
	60	0.24	31	24	19.0	15.8	13.6	11.9	9.5	7.9	6.8	5.9	5.3	4.8	4.3
75	0.27	35	27	21	17.8	15.3	13.4	10.7	8.9	7.6	6.7	5.9	5.3	4.9	
90	0.30	38	30	24	19.8	17.0	14.9	11.9	9.9	8.5	7.4	6.6	5.9	5.4	
025	15	0.15	19	14.9	11.9	9.9	8.5	7.4	5.9	5.0	4.2	3.7	3.3	3.0	2.7
	20	0.18	23	17.8	14.3	11.9	10.2	8.9	7.1	5.9	5.1	4.5	4.0	3.6	3.2
	30	0.22	28	22	17.4	14.5	12.4	10.9	8.7	7.3	6.2	5.4	4.8	4.4	4.0
	40	0.25	32	25	19.8	16.5	14.1	12.4	9.9	8.3	7.1	6.2	5.5	5.0	4.5
	50	0.28	36	28	22	18.5	15.8	13.9	11.1	9.2	7.9	6.9	6.2	5.5	5.0
	60	0.31	40	31	25	20	17.5	15.3	12.3	10.2	8.8	7.7	6.8	6.1	5.6
75	0.34	44	34	27	22	19.2	16.8	13.5	11.2	9.6	8.4	7.5	6.7	6.1	
90	0.38	49	38	30	25	21	18.8	15.0	12.5	10.7	9.4	8.4	7.5	6.8	
03	15	0.18	23	17.8	14.3	11.9	10.2	8.9	7.1	5.9	5.1	4.5	4.0	3.6	3.2
	20	0.21	27	21	16.6	13.9	11.9	10.4	8.3	6.9	5.9	5.2	4.6	4.2	3.8
	30	0.26	33	26	21	17.2	14.7	12.9	10.3	8.6	7.4	6.4	5.7	5.1	4.7
	40	0.30	38	30	24	19.8	17.0	14.9	11.9	9.9	8.5	7.4	6.5	5.9	5.4
	50	0.34	44	34	27	22	19.2	16.8	13.5	11.2	9.6	8.4	7.5	6.7	6.1
	60	0.37	47	37	29	24	21	18.3	14.7	12.2	10.5	9.2	8.1	7.3	6.7
75	0.41	52	41	32	27	23	20	16.2	13.5	11.6	10.1	9.0	8.1	7.4	
90	0.45	58	45	36	30	25	22	17.8	14.9	12.7	11.1	9.9	8.9	8.1	
035	15	0.21	27	21	16.6	13.9	11.9	10.4	8.3	6.9	5.9	5.2	4.6	4.2	3.8
	20	0.25	32	25	19.8	16.5	14.1	12.4	9.9	8.3	7.1	6.2	5.5	5.0	4.5
	30	0.30	38	30	24	19.8	17.0	14.9	11.9	9.9	8.5	7.4	6.6	5.9	5.4
	40	0.35	45	35	28	23	19.8	17.3	13.9	11.6	9.9	8.7	7.7	6.9	6.3
	50	0.39	50	39	31	26	22	19.3	15.4	12.9	11.0	9.7	8.6	7.7	7.0
	60	0.43	55	43	34	28	24	21	17.0	14.2	12.2	10.6	9.5	8.5	7.7
75	0.48	61	48	38	32	27	24	19.0	15.8	13.6	11.9	10.6	9.5	8.6	
90	0.53	68	52	42	35	30	26	21	17.5	15.0	13.1	11.7	10.5	9.5	
04	15	0.24	31	24	19.0	15.8	13.6	11.9	9.5	7.9	6.8	5.9	5.3	4.8	4.3
	20	0.28	36	28	22	18.5	15.8	13.9	11.1	9.2	7.9	6.9	6.2	5.5	5.0
	30	0.35	45	35	28	23	19.8	17.3	13.9	11.6	9.9	8.7	7.7	6.9	6.3
	40	0.40	51	40	32	26	23	19.8	15.8	13.2	11.3	9.9	8.8	7.9	7.2
	50	0.45	58	45	36	30	25	22	17.8	14.9	12.7	11.1	9.9	8.9	8.1
	60	0.49	63	49	39	32	28	24	19.4	16.2	13.9	12.1	10.8	9.7	8.8
75	0.55	70	54	44	36	31	27	22	18.2	15.6	13.6	12.1	10.9	9.9	
90	0.60	77	59	48	40	34	30	24	19.8	17.0	14.9	13.2	11.9	10.8	
05	15	0.31	40	31	25	20	17.5	15.3	12.3	10.2	8.8	7.7	6.8	6.1	5.6
	20	0.35	45	35	28	23	19.8	17.3	13.9	11.6	9.9	8.7	7.7	6.9	6.3
	30	0.43	55	43	34	28	24	21	17.0	14.2	12.2	10.6	9.5	8.5	7.7
	40	0.50	64	50	40	33	28	25	19.8	16.5	14.1	12.4	11.0	9.9	9.0
	50	0.56	72	55	44	37	32	28	22	18.5	15.8	13.9	12.3	11.1	10.1
	60	0.61	78	60	48	40	35	30	24	20	17.3	15.1	13.4	12.1	11.0
75	0.68	87	67	54	45	38	34	27	22	19.2	16.8	15.0	13.5	12.2	
90	0.75	96	74	59	50	42	37	30	25	21	18.6	16.5	14.9	13.5	
06	15	0.37	47	37	29	24	21	18.3	14.7	12.2	10.5	9.2	8.1	7.3	6.7
	20	0.42	54	42	33	28	24	21	16.6	13.9	11.9	10.4	9.2	8.1	7.3
	30	0.52	67	51	41	34	29	26	21	17.2	14.7	12.9	11.4	10.3	9.4
	40	0.60	77	59	48	40	34	30	24	19.8	17.0	14.9	13.2	11.9	10.8
	50	0.67	86	66	53	44	38	33	27	22	19.0	16.6	14.7	13.3	12.1
	60	0.73	93	72	58	48	41	36	29	24	21	18.1	16.1	14.5	13.1
75	0.82	105	81	65	54	46	41	32	27	23	20	18.0	16.2	14.8	
90	0.90	115	89	71	59	51	45	36	30	25	22	19.8	17.8	16.2	
08	15	0.49	63	49	39	32	28	24	19.4	16.2	13.9	12.1	10.8	9.7	8.8
	20	0.57	73	56	45	38	32	28	23	18.8	16.1	14.1	12.5	11.3	10.3
	30	0.69	88	68	55	46	39	34	27	23	19.5	17.1	15.2	13.7	12.4
	40	0.80	102	78	63	53	45	40	32	26	23	19.8	17.6	15.8	14.4
	50	0.89	114	88	70	59	50	44	35	29	25	22	19.6	17.6	16.0
	60	0.98	125	97	78	65	55	49	39	32	28	24	22	19.4	17.6
75	1.10	141	109	87	73	62	54	44	36	31	27	24	22	19.8	
90	1.20	154	119	95	79	68	59	48	40	34	30	26	24	22	
10	15	0.61	78	60	48	40	35	30	24	20	17.3	15.1	13.4	12.1	11.0
	20	0.71	91	70	56	47	40	35	28	23	20	17.6	15.6	14.1	12.8
	30	0.87	111	86	69	57	49	43	34	29	25	22	19.1	17.2	15.7
	40	1.00	128	99	79	66	57	50	40	33	28	25	22	19.8	18.0
	50	1.12	143	111	89	74	63	55	44	37	32	28	25	22	20
	60	1.22	156	121	97	81	69	60	48	40	35	30	27	24	22
75	1.37	175	136	109	90	78	68	54	45	39	34	30	27	25	
90	1.50	192	149	119	99	85	74	59	50	42	37	33	30	27	
12	15	0.73	93	72	58	48	41	36	29	24	21	18.1	16.1	14.5	13.1
	20	0.85	109	84	67	56	48	42	34	28	24	21	18.7	16.8	15.3
	30	1.04	133	103	82	69	59	51	41	34	29	26	23	21	18.7
	40	1.20	154	119	95	79	68	59	48	40	34	30	26	24	22
	50	1.34	172	133	106	88	76	66	53	44	38	33	29	27	24
	60	1.47	188	146	116	97	83	73	58	49	42	36	32	29	26
75	1.64	210	162	130	108	93	81	65	54	46	41	36	32	30	
90	1.80	230	178	143	119	102	89	71	59	51	45	40	36	32	
15	15	0.92	118	91	73	61	52	46	36	30	26	23			



# UNIVERSAL APPLICATION RATE CHART FOR 20" TIP SPACING

TIP CAPACITY	LIQUID PRESSURE IN PSI	CAPACITY ONE TIP IN GPM	CAPACITY ONE TIP IN OZ/MIN	GALLONS PER ACRE – 20" SPRAY TIP SPACING											
				4 MPH	5 MPH	6 MPH	7 MPH	8 MPH	10 MPH	12 MPH	14 MPH	16 MPH	18 MPH	20 MPH	22 MPH
01	15	0.061	7.8	4.5	3.6	3.0	2.6	2.3	1.8	1.5	1.3	1.1	1.0	0.91	0.82
	20	0.071	9.1	5.3	4.2	3.5	3.0	2.6	2.1	1.8	1.5	1.3	1.2	1.1	0.96
	30	0.087	11	6.5	5.2	4.3	3.7	3.2	2.6	2.2	1.8	1.6	1.4	1.3	1.2
	40	0.10	13	7.4	5.9	5.0	4.2	3.7	3.0	2.5	2.1	1.9	1.7	1.5	1.4
	50	0.12	15	8.2	6.5	5.4	4.7	4.1	3.3	2.7	2.3	2.0	1.8	1.6	1.5
	60	0.14	17	8.9	7.1	5.9	5.1	4.5	3.6	3.0	2.5	2.2	2.0	1.8	1.6
75	0.18	18	10.4	8.3	6.9	5.9	5.2	4.2	3.5	3.0	2.6	2.3	2.1	1.9	
90	0.15	19	11.1	8.9	7.4	6.4	5.6	4.5	3.7	3.2	2.8	2.5	2.2	2.0	
015	15	0.092	12	6.8	5.5	4.6	3.9	3.4	2.7	2.3	2.0	1.7	1.5	1.4	1.2
	20	0.11	14	8.2	6.5	5.4	4.7	4.1	3.3	2.7	2.3	2.0	1.8	1.6	1.5
	30	0.13	17	9.7	7.7	6.4	5.5	4.8	3.9	3.2	2.8	2.4	2.1	1.9	1.8
	40	0.15	19	11.1	8.9	7.4	6.4	5.6	4.5	3.7	3.2	2.8	2.5	2.2	2.0
	50	0.17	22	12.6	10.1	8.4	7.2	6.3	5.0	4.2	3.6	3.2	2.8	2.5	2.3
	60	0.18	23	13.4	10.7	8.9	7.6	6.7	5.3	4.5	3.8	3.3	3.0	2.7	2.4
75	0.21	27	15.6	12.5	10.4	8.9	7.8	6.2	5.2	4.5	3.9	3.5	3.1	2.8	
90	0.23	29	17.1	13.7	11.4	9.8	8.5	6.8	5.7	4.9	4.3	3.8	3.4	3.1	
02	15	0.12	15	8.9	7.1	5.9	5.1	4.5	3.6	3.0	2.5	2.2	2.0	1.8	1.6
	20	0.14	18	10.4	8.3	6.9	5.9	5.2	4.2	3.5	3.0	2.6	2.3	2.1	1.9
	30	0.17	22	12.6	10.1	8.4	7.2	6.3	5.0	4.2	3.6	3.2	2.8	2.5	2.3
	40	0.20	26	14.9	11.9	9.9	8.5	7.4	5.9	5.0	4.2	3.7	3.3	3.0	2.7
	50	0.22	28	16.3	13.1	10.9	9.3	8.2	6.5	5.4	4.7	4.1	3.6	3.3	3.0
	60	0.24	31	17.8	14.3	11.9	10.2	8.9	7.1	5.9	5.1	4.5	4.0	3.6	3.2
75	0.27	35	20	16.0	13.4	11.5	10.0	8.0	6.7	5.7	5.0	4.5	4.0	3.6	
90	0.30	38	22	17.8	14.9	12.7	11.1	8.9	7.4	6.4	5.6	5.0	4.5	4.1	
025	15	0.15	19	11.1	8.9	7.4	6.4	5.6	4.5	3.7	3.2	2.8	2.5	2.2	2.0
	20	0.18	23	13.4	10.7	8.9	7.6	6.7	5.3	4.5	3.8	3.3	3.0	2.7	2.4
	30	0.22	28	16.3	13.1	10.9	9.3	8.2	6.5	5.4	4.7	4.1	3.6	3.3	3.0
	40	0.25	32	18.6	14.9	12.4	10.6	9.3	7.4	6.2	5.3	4.6	4.1	3.7	3.4
	50	0.28	36	21	16.6	13.9	11.9	10.4	8.3	6.9	5.9	5.2	4.6	4.2	3.8
	60	0.31	40	23	18.4	15.3	13.2	11.5	9.2	7.7	6.6	5.8	5.1	4.6	4.2
75	0.34	44	25	20	16.8	14.4	12.6	10.1	8.4	7.2	6.3	5.6	5.0	4.6	
90	0.38	49	28	23	18.8	16.1	14.1	11.3	9.4	8.1	7.1	6.3	5.6	5.1	
03	15	0.18	23	13.4	10.7	8.9	7.6	6.7	5.3	4.5	3.8	3.3	3.0	2.7	2.4
	20	0.21	27	15.6	12.5	10.4	8.9	7.8	6.2	5.2	4.5	3.9	3.5	3.1	2.8
	30	0.26	33	19.3	15.4	12.9	11.0	9.7	7.7	6.4	5.5	4.8	4.3	3.9	3.5
	40	0.30	38	22	17.8	14.9	12.7	11.1	8.9	7.4	6.4	5.6	5.0	4.5	4.1
	50	0.34	44	25	20	16.8	14.4	12.6	10.1	8.4	7.2	6.3	5.6	5.0	4.6
	60	0.37	47	27	22	18.3	15.7	13.7	11.0	9.2	7.8	6.9	6.1	5.5	5.0
75	0.41	52	30	24	20	17.4	15.2	12.2	10.1	8.7	7.6	6.8	6.1	5.5	
90	0.45	58	33	27	22	19.1	16.7	13.4	11.1	9.5	8.4	7.4	6.7	6.1	
035	15	0.21	27	15.6	12.5	10.4	8.9	7.8	6.2	5.2	4.5	3.9	3.5	3.1	2.8
	20	0.25	32	18.6	14.9	12.4	10.6	9.3	7.4	6.2	5.3	4.6	4.1	3.7	3.4
	30	0.30	38	22	17.8	14.9	12.7	11.1	8.9	7.4	6.4	5.6	5.0	4.5	4.1
	40	0.35	45	26	21	17.3	14.9	13.0	10.4	8.7	7.4	6.5	5.8	5.2	4.7
	50	0.39	50	29	23	19.3	16.5	14.5	11.6	9.7	8.3	7.2	6.4	5.8	5.3
	60	0.43	55	32	26	21	18.2	16.0	12.8	10.6	9.1	8.0	7.1	6.4	5.8
75	0.48	61	36	29	24	20	17.8	14.3	11.9	10.2	8.9	7.9	7.1	6.5	
90	0.53	68	39	31	26	22	19.7	15.7	13.1	11.2	9.8	8.7	7.9	7.2	
04	15	0.24	31	17.8	14.3	11.9	10.2	8.9	7.1	5.9	5.1	4.5	4.0	3.6	3.2
	20	0.28	36	21	16.6	13.9	11.9	10.4	8.3	6.9	5.9	5.2	4.6	4.2	3.8
	30	0.35	45	26	21	17.3	14.9	13.0	10.4	8.7	7.4	6.5	5.8	5.2	4.7
	40	0.40	51	30	24	19.8	17.0	14.9	11.9	9.9	8.5	7.4	6.6	5.9	5.4
	50	0.45	58	33	27	22	19.1	16.7	13.4	11.1	9.5	8.4	7.4	6.7	6.1
	60	0.49	63	36	29	24	21	18.2	14.6	12.1	10.4	9.1	8.1	7.3	6.6
75	0.55	70	41	33	27	23	20	16.3	13.6	11.7	10.2	9.1	8.2	7.4	
90	0.60	77	45	36	30	25	22	17.8	14.9	12.7	11.1	9.9	8.9	8.1	
05	15	0.31	40	23	18.4	15.3	13.2	11.5	9.2	7.7	6.6	5.8	5.1	4.6	4.2
	20	0.35	45	26	21	17.3	14.9	13.0	10.4	8.7	7.4	6.5	5.8	5.2	4.7
	30	0.43	55	32	26	21	18.2	16.0	12.8	10.6	9.1	8.0	7.1	6.4	5.8
	40	0.50	64	37	30	25	21	18.6	14.9	12.4	10.6	9.3	8.3	7.4	6.8
	50	0.56	72	42	33	28	24	21	16.6	13.9	11.9	10.4	9.2	8.3	7.6
	60	0.61	78	45	36	30	26	23	18.1	15.1	12.9	11.3	10.1	9.1	8.2
75	0.68	87	50	40	34	29	25	20	16.8	14.4	12.6	11.2	10.1	9.2	
90	0.75	96	56	45	37	32	28	22	18.6	15.9	13.9	12.4	11.1	10.1	
06	15	0.37	47	27	22	18.3	15.7	13.7	11.0	9.2	7.8	6.9	6.1	5.5	5.0
	20	0.42	54	31	25	21	17.8	15.6	12.5	10.4	8.9	7.8	6.9	6.1	5.5
	30	0.52	67	39	31	26	22	19.3	15.4	12.9	11.0	9.7	8.6	7.7	7.0
	40	0.60	77	45	36	30	25	22	17.8	14.9	12.7	11.1	9.9	8.9	8.1
	50	0.67	86	50	40	33	28	25	19.9	16.6	14.2	12.4	11.1	9.9	9.0
	60	0.73	93	54	43	36	31	27	22	18.1	15.5	13.6	12.0	10.8	9.9
75	0.82	105	61	49	41	35	30	24	20	17.4	15.2	13.5	12.2	11.1	
90	0.90	115	67	53	45	38	33	27	22	19.1	16.7	14.9	13.4	12.2	
08	15	0.49	63	36	29	24	21	18.2	14.6	12.1	10.4	9.1	8.1	7.3	6.6
	20	0.57	73	42	34	28	24	21	16.9	14.1	12.1	10.6	9.4	8.5	7.7
	30	0.69	88	51	41	34	29	26	20	17.1	14.6	12.8	11.4	10.2	9.3
	40	0.80	102	59	48	40	34	30	24	19.8	17.0	14.9	13.2	11.9	10.8
	50	0.98	114	66	53	44	38	33	26	22	18.9	16.5	14.7	13.2	12.0
	60	0.98	125	73	58	49	42	36	29	24	21	18.2	16.2	14.6	13.2
75	1.10	141	82	65	54	47	41	33	27	23	20	18.2	16.3	14.9	
90	1.20	154	89	71	59	51	45	36	30	25	22	19.8	17.8	16.2	
10	15	0.61	78	45	36	30	26	23	18.1	15.1	12.9	11.3	10.1	9.1	8.2
	20	0.71	91	53	42	35	30	26	21	17.6	15.1	13.2	11.7	10.5	9.6
	30	0.87	111	65	52	43	37	32	26	22	18.5	16.1	14.4	12.9	11.7
	40	1.00	128	74	59	50	42	37	30	25	21	18.6	16.5	14.9	13.5
	50	1.12	143	83	67	55	48	42	33	28	24	21	18.5	16.6	15.1
	60	1.22	156	91	72	60	52	45	36	30	26	23	20	18.1	16.5
75	1.37	175	102	81	68	58	51	41	34	29	25	23	20	18.5	
90	1.50	192	111	89	74	64	56	45	37	32	28	25	22	20	
12	15	0.73	93	54	43	36	31	27	22	18.1	15.5	13.6	12.0	10.8	9.9
	20	0.85	109	63	50	42	36	32	25	21	18.0	15.8	14.0	12.6	11.5
	30	1.04	133	77	62	51	44	39	31	26	22	19.3	17.2	15.4	14.0
	40	1.20	154	89	71	59	51	45	36	30	25	22	19.8	17.8	16.2
	50	1.34	172	99	80	66	57	50	40	33	28	25	22	19.9	18.1
	60	1.47	188	109	87	73	62	54	44	36	31	27	24	22	19.8
75	1.64	210	122	97	81	70	61	49	41	35	30	27	24	22	
90	1.80	230	134	107	89	76	67	53	45	38	33	30	27	24	





# UNIVERSAL APPLICATION RATE CHART FOR 30" TIP SPACING

TIP CAPACITY	LIQUID PRESSURE IN PSI	CAPACITY ONE TIP IN GPM	CAPACITY ONE TIP IN OZ/MIN	GALLONS PER ACRE – 30" SPRAY TIP SPACING											
				4 MPH	5 MPH	6 MPH	7 MPH	8 MPH	10 MPH	12 MPH	14 MPH	16 MPH	18 MPH	20 MPH	22 MPH
01	15	0.061	7.8	3.0	2.4	2.0	1.7	1.5	1.2	1.0	0.86	0.75	0.67	0.60	0.55
	20	0.071	9.1	3.5	2.8	2.3	2.0	1.8	1.4	1.2	1.0	0.88	0.78	0.70	0.64
	30	0.087	11	4.3	3.4	2.9	2.5	2.2	1.7	1.4	1.2	1.1	0.96	0.86	0.78
	40	0.10	13	5.0	4.0	3.3	2.8	2.5	2.0	1.7	1.4	1.2	1.1	0.99	0.90
	50	0.11	14	5.4	4.4	3.6	3.1	2.7	2.2	1.8	1.6	1.4	1.2	1.1	1.1
	60	0.12	15	5.9	4.8	4.0	3.4	3.0	2.4	2.0	1.7	1.5	1.3	1.2	1.1
	75	0.14	18	6.9	5.5	4.6	4.0	3.5	2.8	2.3	2.0	1.7	1.5	1.4	1.3
90	0.15	19	7.4	5.9	5.0	4.2	3.7	3.0	2.5	2.1	1.9	1.7	1.5	1.4	
015	15	0.092	12	4.6	3.6	3.0	2.6	2.3	1.8	1.5	1.3	1.1	1.0	0.9	0.8
	20	0.11	14	5.4	4.4	3.6	3.1	2.7	2.2	1.8	1.6	1.4	1.2	1.1	1.0
	30	0.13	17	6.4	5.1	4.3	3.7	3.2	2.6	2.1	1.8	1.6	1.4	1.3	1.2
	40	0.15	19	7.4	5.9	5.0	4.2	3.7	3.0	2.5	2.1	1.9	1.7	1.5	1.4
	50	0.17	22	8.4	6.7	5.6	4.8	4.2	3.4	2.8	2.4	2.1	1.9	1.7	1.5
	60	0.18	23	8.9	7.1	5.9	5.1	4.5	3.6	3.0	2.5	2.2	2.0	1.8	1.6
	75	0.21	27	10.4	8.3	6.9	5.9	5.2	4.2	3.5	3.0	2.6	2.3	2.1	1.9
90	0.23	29	11.4	9.1	7.6	6.5	5.7	4.6	3.8	3.3	2.8	2.5	2.3	2.1	
02	15	0.12	15	5.9	4.8	4.0	3.4	3.0	2.4	2.0	1.7	1.5	1.3	1.2	1.1
	20	0.14	18	6.9	5.5	4.6	4.0	3.5	2.8	2.3	2.0	1.7	1.5	1.4	1.3
	30	0.17	22	8.4	6.7	5.6	4.8	4.2	3.4	2.8	2.4	2.1	1.9	1.7	1.5
	40	0.20	26	9.9	7.9	6.6	5.7	5.0	4.0	3.3	2.8	2.5	2.2	2.0	1.8
	50	0.22	28	10.9	8.7	7.3	6.2	5.4	4.4	3.6	3.1	2.7	2.4	2.2	2.0
	60	0.24	31	11.9	9.5	7.9	6.8	5.9	4.8	4.0	3.4	3.0	2.6	2.4	2.2
	75	0.27	35	13.4	10.7	8.9	7.6	6.7	5.3	4.5	3.8	3.3	3.0	2.7	2.4
90	0.30	38	14.9	11.9	9.9	8.5	7.4	5.9	5.0	4.2	3.7	3.3	3.0	2.7	
025	15	0.15	19	7.4	5.9	5.0	4.2	3.7	3.0	2.5	2.1	1.9	1.7	1.5	1.4
	20	0.18	23	8.9	7.1	5.9	5.1	4.5	3.6	3.0	2.5	2.2	2.0	1.8	1.6
	30	0.22	28	10.9	8.7	7.3	6.2	5.4	4.4	3.6	3.1	2.7	2.4	2.2	2.0
	40	0.25	32	12.4	9.9	8.3	7.1	6.2	5.0	4.1	3.5	3.1	2.8	2.5	2.3
	50	0.28	36	13.9	11.1	9.2	7.9	6.9	5.5	4.6	4.0	3.5	3.1	2.8	2.5
	60	0.31	40	15.3	12.3	10.2	8.8	7.7	6.1	5.1	4.4	3.8	3.4	3.1	2.8
	75	0.34	44	16.8	13.5	11.2	9.6	8.4	6.7	5.6	4.8	4.2	3.7	3.4	3.1
90	0.38	49	18.8	15.0	12.5	10.7	9.4	7.5	6.3	5.4	4.7	4.2	3.8	3.4	
03	15	0.18	23	8.9	7.1	5.9	5.1	4.5	3.6	3.0	2.5	2.2	2.0	1.8	1.6
	20	0.21	27	10.4	8.3	6.9	5.9	5.2	4.2	3.5	3.0	2.6	2.3	2.1	1.9
	30	0.26	33	12.9	10.3	8.6	7.4	6.4	5.1	4.3	3.7	3.2	2.9	2.6	2.3
	40	0.30	38	14.9	11.9	9.9	8.5	7.4	5.9	5.0	4.2	3.7	3.3	3.0	2.7
	50	0.44	44	16.8	13.5	11.2	9.6	8.4	6.7	5.6	4.8	4.2	3.7	3.4	3.1
	60	0.37	47	18.3	14.7	12.2	10.5	9.2	7.4	6.1	5.2	4.6	4.1	3.7	3.3
	75	0.41	52	20	16.2	13.5	11.6	10.1	8.1	6.8	5.8	5.1	4.5	4.1	3.7
90	0.45	58	22	17.8	14.9	12.7	11.1	8.9	7.4	6.4	5.6	5.0	4.5	4.1	
035	15	0.21	27	10.4	8.3	6.9	5.9	5.2	4.2	3.5	3.0	2.6	2.3	2.1	1.9
	20	0.25	32	12.4	9.9	8.3	7.1	6.2	5.0	4.1	3.5	3.1	2.8	2.5	2.3
	30	0.30	38	14.9	11.9	9.9	8.5	7.4	5.9	5.0	4.2	3.7	3.3	3.0	2.7
	40	0.35	45	17.3	13.9	11.6	9.9	8.7	6.9	5.8	5.0	4.3	3.9	3.5	3.2
	50	0.39	50	19.3	15.4	12.9	11.0	9.7	7.7	6.4	5.5	4.8	4.3	3.9	3.5
	60	0.43	55	21	17.0	14.2	12.2	10.6	8.5	7.1	6.1	5.3	4.7	4.3	3.9
	75	0.48	61	24	19.0	15.8	13.6	11.9	9.5	7.9	6.8	5.9	5.3	4.8	4.3
90	0.53	68	26	21	17.5	15.0	13.1	10.5	8.7	7.5	6.6	5.8	5.2	4.8	
04	15	0.24	31	11.9	9.5	7.9	6.8	5.9	4.8	4.0	3.4	3.0	2.6	2.4	2.2
	20	0.28	36	13.9	11.1	9.2	7.9	6.9	5.5	4.6	4.0	3.5	3.1	2.8	2.5
	30	0.35	45	17.3	13.9	11.6	9.9	8.7	6.9	5.8	5.0	4.3	3.9	3.5	3.2
	40	0.40	51	19.8	15.8	13.2	11.3	9.9	7.9	6.6	5.7	5.0	4.4	4.0	3.6
	50	0.45	58	22	17.8	14.9	12.7	11.1	8.9	7.4	6.4	5.6	5.0	4.5	4.1
	60	0.49	63	24	19.4	16.2	13.9	12.1	9.7	8.1	6.9	6.1	5.4	4.9	4.4
	75	0.55	70	27	22	18.2	15.6	13.6	10.9	9.1	7.8	6.8	6.1	5.4	5.0
90	0.60	77	30	24	19.8	17.0	14.9	11.9	9.9	8.5	7.4	6.6	5.9	5.4	
05	15	0.31	40	15.3	12.3	10.2	8.8	7.7	6.1	5.1	4.4	3.8	3.4	3.1	2.8
	20	0.35	45	17.3	13.9	11.6	9.9	8.7	6.9	5.8	5.0	4.3	3.9	3.5	3.2
	30	0.43	55	21	17.0	14.2	12.2	10.6	8.5	7.1	6.1	5.3	4.7	4.3	3.9
	40	0.50	64	25	19.8	16.5	14.1	12.4	9.9	8.3	7.1	6.2	5.5	5.0	4.5
	50	0.56	72	28	22	18.5	15.8	13.9	11.1	9.2	7.9	6.9	6.2	5.5	5.0
	60	0.61	78	30	24	20	17.3	15.1	12.1	10.1	8.6	7.5	6.7	6.0	5.5
	75	0.68	87	34	27	22	19.2	16.8	13.5	11.2	9.6	8.4	7.5	6.7	6.1
90	0.75	96	37	30	25	21	18.6	14.9	12.4	10.6	9.3	8.3	7.4	6.8	
06	15	0.37	47	18.3	14.7	12.2	10.5	9.2	7.3	6.1	5.2	4.6	4.1	3.7	3.3
	20	0.42	54	21	16.6	13.9	11.9	10.4	8.3	6.9	5.9	5.2	4.6	4.2	3.8
	30	0.52	67	26	21	17.2	14.7	12.9	10.3	8.6	7.4	6.4	5.7	5.1	4.7
	40	0.60	77	30	24	19.8	17.0	14.9	11.9	9.9	8.5	7.4	6.6	5.9	5.4
	50	0.67	86	33	27	22	19.0	16.5	13.3	11.1	9.5	8.3	7.4	6.6	6.0
	60	0.73	93	36	29	24	21	18.1	14.5	12.0	10.3	9.0	8.0	7.2	6.6
	75	0.82	105	41	32	27	23	20	16.2	13.5	11.6	10.1	9.0	8.1	7.4
90	0.90	115	45	36	30	25	22	17.8	14.9	12.7	11.1	9.9	8.9	8.1	
08	15	0.49	63	24	19.4	16.2	13.9	12.1	9.7	8.1	6.9	6.1	5.4	4.9	4.4
	20	0.57	73	28	23	18.8	16.1	14.1	11.3	9.4	8.1	7.1	6.3	5.6	5.1
	30	0.69	88	34	27	23	19.5	17.1	13.7	11.4	9.8	8.5	7.6	6.8	6.2
	40	0.80	102	40	32	26	23	19.8	15.8	13.2	11.3	9.9	8.8	7.9	7.2
	50	0.89	114	44	35	29	25	22	17.6	14.7	12.6	11.0	9.8	8.8	8.0
	60	0.98	125	49	39	32	28	24	19.4	16.2	13.9	12.1	10.8	9.7	8.8
	75	1.10	141	54	44	36	31	27	22	18.2	15.6	13.6	12.1	10.9	9.9
90	1.20	154	59	48	40	34	30	24	19.8	17.0	14.9	13.2	11.9	10.8	
10	15	0.61	78	30	24	20	17.3	15.1	12.1	10.1	8.6	7.5	6.7	6.0	5.5
	20	0.71	91	35	28	23	20	17.6	14.1	11.7	10.0	8.8	7.8	7.0	6.4
	30	0.87	111	43	34	29	25	22	17.2	14.4	12.3	10.8	9.6	8.6	7.8
	40	1.00	128	50	40	33	28	25	19.8	16.5	14.1	12.4	11.0	9.9	9.0
	50	1.12	143	55	44	37	32	28	22	18.5	15.8	13.9	12.3	11.1	10.1
	60	1.22	156	60	48	40	35	30	24	20	17.3	15.1	13.4	12.1	11.0
	75	1.37	175	68	54	45	39	34	27	23	19.4	17.0	15.1	13.6	12.3
90	1.50	192	74	59	50	42	37	30	25	21	18.6	16.5	14.9	13.5	
12	15	0.73	93	36	29	24	21	18.1	14.5	12.0	10.3	9.0	8.0	7.2	6.6
	20	0.85	109	42	34	28	24	21	16.8	14.0	12.0	10.5	9.4	8.4	7.7
	30	1.04	133	51	41	34	29	26	21	17.2	14.7	12.9	11.4	10.3	9.4
	40	1.20	154	59	48	40	34	30	24	19.8	17.0	14.9	13.2	11.9	10.8
	50	1.34	172	66	53	44	38	33	27	22	19.0	16.6	14.7	13.3	12.1
	60	1.47	188	73	58	49	42	36	29	24	21	18.2	16.2	14.6	13.2
	75	1.64	210	81	65	54	46	41	32	27	23	20	18.0	16.2	14.8
90															



**WATER SENSITIVE PAPER**

These specially coated papers are used for evaluating spray distributions, swath widths, droplet densities and penetration of spray. Water sensitive paper is yellow and is stained blue by exposure to aqueous spray droplets. For more information on water sensitive paper see Data Sheet 20301.

Water sensitive paper sold by TeeJet Technologies is manufactured by Syngenta Crop Protection AG.

PART NUMBER	PAPER SIZE (IN)	QTY/PKG
20301-1N	3 x 1	50 Cards
20301-2N	3 x 2	50 Cards
20301-3N	20 x 1	25 Strips

**HOW TO ORDER**

2 0 3 0 1 - 1 N



**TEEJET TIP CLEANING BRUSH**

**HOW TO ORDER**

C P 2 0 0 1 6 - N Y



**TEEJET CALIBRATION CONTAINER**

The TeeJet Calibration Container features a 68 oz capacity and a raised dual scale in both U.S. and metric graduations. The container is molded of polypropylene for excellent chemical resistance and durability.

**HOW TO ORDER**

C P 2 4 0 3 4 A - P P



## USEFUL FORMULAS

$$\text{GPM (per nozzle)} = \frac{\text{GPA} \times \text{MPH} \times \text{W}}{5,940}$$

$$\text{GPM (per nozzle)} = \frac{\text{GAL}/1000 \text{ ft}^2 \times \text{MPH} \times \text{W}}{136}$$

$$\text{GPA} = \frac{5,940 \times \text{GPM (per nozzle)}}{\text{MPH} \times \text{W}}$$

$$\text{GAL}/1000 \text{ ft}^2 = \frac{136 \times \text{GPM (per nozzle)}}{\text{MPH} \times \text{W}}$$

GPM – Gallons per minute

GPA – Gallons per acre

GAL/1000 ft<sup>2</sup> – Gallons per 1000 square feet

MPH – Miles per hour

W – Nozzle spacing (in inches) for broadcast spraying

– Spray width (in inches) for single nozzle, band spraying or boomless spraying

– Row spacing (in inches) divided by the number of nozzles per row for directed spraying



## USEFUL FORMULAS FOR ROADWAY APPLICATIONS

$$\text{GPLM} = \frac{60 \times \text{GPM}}{\text{MPH}} \quad \text{GPM} = \frac{\text{GPLM} \times \text{MPH}}{60}$$

GPLM = Gallons per lane mile

**Note:** GPLM is not a normal volume per unit area measurement. It is a volume per distance measurement. Increases or decreases in lane width (swath width) are not accommodated by these formulas.

## MEASURING TRAVEL SPEED

Measure a test course in the area to be sprayed or in an area with similar surface conditions. Minimum lengths of 100 and 200 feet are recommended for measuring speeds up to 5 and 10 MPH, respectively. Determine the time required to travel the test course. To help ensure accuracy, conduct the speed check with a partially loaded (about half full) sprayer and select the engine throttle setting and gear that will be used when spraying. Repeat the above process and average the times that were measured. Use the following equation or the table at right to determine ground speed.

$$\text{Speed (MPH)} = \frac{\text{Distance (FT)} \times 60}{\text{Time (seconds)} \times 88}$$

## SPEEDS

SPEED IN MPH	TIME REQUIRED IN SECONDS TO TRAVEL A DISTANCE OF:		
	100 FT	200 FT	300 FT
1.0	68	136	205
1.5	45	91	136
2.0	34	68	102
2.5	27	55	82
3.0	23	45	68
3.5	19	39	58
4.0	17	34	51
4.5	15	30	45
5.0	14	27	41
5.5	—	25	37
6.0	—	23	34
6.5	—	21	31
7.0	—	19	29
7.5	—	18	27
8.0	—	17	26
8.5	—	16	24
9.0	—	15	23

## NOZZLE SPACING

If the nozzle spacing on your boom is different than those tabulated, multiply the tabulated GPA coverages by one of the following factors. Different application rate charts for different spacing can be found on pages 179–182.

20" SPACING	
OTHER SPACING (IN)	CONVERSION FACTOR
8	2.5
10	2
12	1.67
14	1.43
16	1.25
18	1.11
22	0.83
24	0.71
30	0.66

30" SPACING	
OTHER SPACING (IN)	CONVERSION FACTOR
26	1.15
28	1.07
32	0.94
34	0.88
36	0.83
38	0.79
40	0.75
42	0.71
44	0.68

40" SPACING	
OTHER SPACING (IN)	CONVERSION FACTOR
28	1.43
30	1.33
32	1.25
34	1.18
36	1.11
38	1.05
42	0.95
44	0.91
48	0.83

## MISCELLANEOUS CONVERSION FACTORS

1 Acre	= 43,560 square feet
	= 43.56 1000 ft <sup>2</sup> Blocks
	= 0.405 Hectare
1 Hectare	= 2.471 Acres
1 GPA	= 2.9 fl oz per 1000 ft <sup>2</sup>
	= 9.35 L/ha
1 GAL per 1000 ft <sup>2</sup>	= 43.56 GPA
1 Mile	= 5,280 ft; 1,610 m
	= 1.61 Kilometers
1 Gallon	= 128 fl oz; 8 Pints
	= 4 Quarts; 3.79 Liters
	= 0.83 Imperial Gallon
1 PSI	= 0.069 bar
	= 6.896 kilopascals
1 MPH	= 1.609 KPH

## SUGGESTED MINIMUM SPRAY HEIGHTS

The nozzle height suggestions in the table below are based on the minimum overlap required to obtain uniform distribution. However, in many cases, typical height adjustments are based on a 1:1 nozzle spacing to height ratio. For example, 110° flat spray tips spaced 20" apart are commonly set 20" above the target.

TIP MODEL	ANGLE	HEIGHT (INCHES)		
		20" SPACING	30" SPACING	40" SPACING
TP, TJ	65°	22–24	33–35	NR*
TP, XR, TX, DG, TJ, AI, XRC	80°	17–19	26–28	NR*
TP, XR, DG, TT, TTI, TJ, DGTJ, AI, AIXR, AIC, XRC, TTJ, AITTJ, TT160, APTJ	110°	16–18	20–22	NR*
FullJet®	120°	10–18**	14–18**	14–18**
FloodJet® TK, TF, K, QCK, QCTF, 1/4TTJ	120°	14–16***	15–17***	18–20***

\* Not recommended.

\*\* Nozzle height based on 30°–45° angle of orientation.

\*\*\* Wide angle spray tip height is influenced by nozzle orientation. The critical factor is to achieve a double spray pattern overlap.

## SPRAYING LIQUIDS WITH A DENSITY OTHER THAN WATER

Since all the tabulations in this catalog are based on spraying water, which weighs 8.34 lbs per USA gallon, conversion factors must be used when spraying liquids that are heavier or lighter than water. To determine the proper size nozzle for the liquid to be sprayed, first multiply the desired GPM or GPA of liquid by the water rate conversion factor. Then use the new converted GPM or GPA rate to select the proper size nozzle.



### Example:

Desired application rate is 20 GPA of 28% N. Determine the correct nozzle size as follows:

$$\text{GPA (liquid other than water)} \times \text{Conversion factor} = \text{GPA (from table in catalog)}$$

$$20 \text{ GPA (28\%)} \times 1.13 = 22.6 \text{ GPA (Water)}$$

The applicator should choose a nozzle size that will supply 22.6 GPA of water at the desired pressure.

WEIGHT OF SOLUTION	SPECIFIC GRAVITY	CONVERSION FACTOR
7.0 lbs/gal	0.84	0.92
8.0 lbs/gal	0.96	0.98
8.34 lbs/gal	1.00-Water	1.00
9.0 lbs/gal	1.08	1.04
10.0 lbs/gal	1.20	1.10
10.65 lbs/gal	1.28-28% Nitrogen	1.13
11.0 lbs/gal	1.32	1.15
12.0 lbs/gal	1.44	1.20
14.0 lbs/gal	1.68	1.30

## SPRAY COVERAGE INFORMATION

This table lists the theoretical coverage of spray patterns as calculated from the included spray angle of the spray and the distance from the nozzle orifice. These values are based on the assumption that the spray angle remains the same throughout the entire spray distance. In actual practice, the tabulated spray angle does not hold for long spray distances.

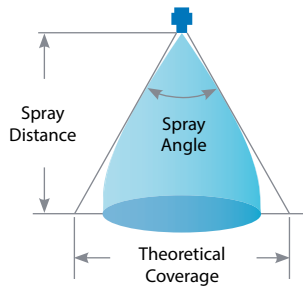

INCLUDED SPRAY ANGLE	THEORETICAL COVERAGE AT VARIOUS SPRAY HEIGHTS							
	8"	10"	12"	15"	18"	24"	30"	36"
15°	2.1	2.6	3.2	3.9	4.7	6.3	7.9	9.5
20°	2.8	3.5	4.2	5.3	6.4	8.5	10.6	12.7
25°	3.5	4.4	5.3	6.6	8.0	10.6	13.3	15.9
30°	4.3	5.4	6.4	8.1	9.7	12.8	16.1	19.3
35°	5.0	6.3	7.6	9.5	11.3	15.5	18.9	22.7
40°	5.8	7.3	8.7	10.9	13.1	17.5	21.8	26.2
45°	6.6	8.3	9.9	12.4	14.9	19.9	24.8	29.8
50°	7.5	9.3	11.2	14.0	16.8	22.4	28.0	33.6
55°	8.3	10.3	12.5	15.6	18.7	25.0	31.2	37.5
60°	9.2	11.5	13.8	17.3	20.6	27.7	34.6	41.6
65°	10.2	12.7	15.3	19.2	22.9	30.5	38.2	45.8
73°	11.8	14.8	17.8	22.0	27.0	36.0	44.0	53.0
80°	13.4	16.8	20.2	25.2	30.3	40.3	50.4	60.4
85°	14.7	18.3	22.0	27.5	33.0	44.0	55.4	66.4
90°	16.0	20.0	24.0	30.0	36.0	48.0	60.0	72.0
95°	17.5	21.8	26.2	32.8	40.3	52.4	65.5	78.6
100°	19.1	23.8	28.6	35.8	43.0	57.2	71.6	85.9
110°	22.8	28.5	34.3	42.8	51.4	68.5	85.6	103
120°	27.7	34.6	41.6	52.0	62.4	83.2	104	
130°	34.3	42.9	51.5	64.4	77.3	103		
140°	43.8	54.8	65.7	82.2	98.6			
150°	59.6	74.5	89.5					

## NOZZLE NOMENCLATURE

There are many types of nozzles available, with each providing different flow rates, spray angles, droplet sizes and patterns. Some of these spray tip characteristics are indicated by the tip number.

**Remember, when replacing tips, be sure to purchase the same tip type, angle, and capacity, thereby ensuring your sprayer remains properly calibrated.**

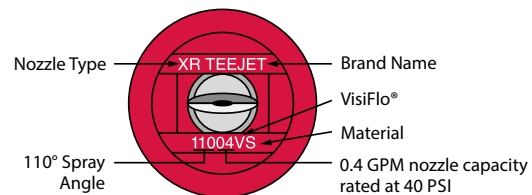

## FLOW RATE

Nozzle flow rate varies with spraying pressure. In general, the relationship between GPM and pressure is as follows:

$$\frac{GPM_1}{GPM_2} = \frac{\sqrt{PSI_1}}{\sqrt{PSI_2}}$$

This equation is explained by the illustration to the right. Simply stated, in order to double the flow through a nozzle, the pressure must be increased four times.

Higher pressure not only increases the flow rate through a nozzle, but it also influences the droplet size, spray angle, and the rate of orifice wear. As pressure is increased, the droplet size decreases and the rate of orifice wear increases.

The values given in the tabulation sections of this catalog indicate the most commonly used pressure ranges for the associated spray tips. When information on the performance of spray tips outside of the pressure range given in this catalog is required, contact TeeJet Technologies or your local rep.

## SPRAY ANGLE & COVERAGE

Depending on the nozzle type and size, the operating pressure can have a significant effect on spray angle and quality of spray distribution. As shown here for an 11002 flat spray tip, lowering the pressure results in a smaller spray angle and a significant reduction in spray coverage.

Tabulations for spray tips in this catalog are based on spraying water. Generally, liquids more viscous than water produce relatively smaller spray angles, while liquids with surface tensions lower than water will produce wider spray angles. In situations where the uniformity of spray distribution is important, be careful to operate your spray tips within the proper pressure range.

**Note:** Suggested minimum spray heights for broadcast spraying are based upon nozzles spraying water at the rated spray angle.

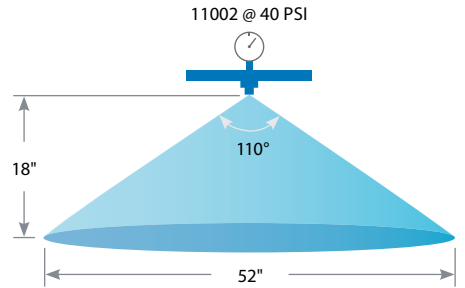
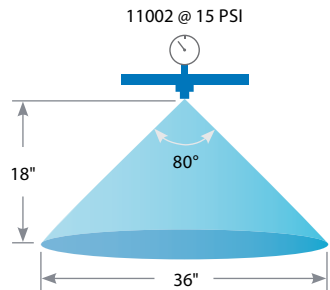
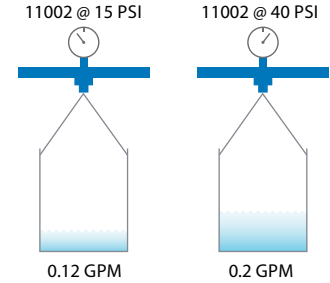

## PRESSURE DROP THROUGH VARIOUS HOSE SIZES

FLOW IN GPM	PRESSURE DROP IN PSI (10' LENGTH WITHOUT COUPLINGS)				
	¼" I.D.	3/8" I.D.	½" I.D.	¾" I.D.	1" I.D.
0.5	1.4	.2			
1.0		.7			
1.5		1.4	.4		
2.0		2.4	.6		
2.5		3.4	.9		
3.0			1.2		
4.0			2.0		
5.0			2.9	.4	
6.0			4.0	.6	
8.0				.9	.3
10.0				1.4	.4

## HELPFUL REMINDERS FOR BAND SPRAYING

Wider angle spray tips allow the spray height to be lowered to minimize drift.

The spray angle of the nozzle and the resulting band width are directly influenced by the spraying pressure.

**Example:** Even Flat Spray

**Example:** 8002E Even Flat Spray

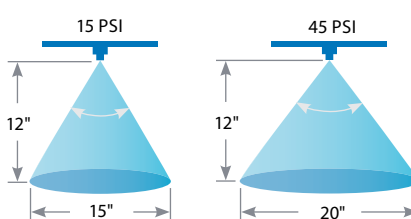
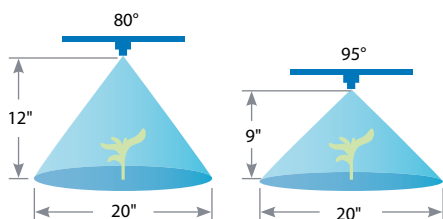

**Use Care When Calculating:**  
Field Acres/Hectares vs.  
Treated Acres/Hectares

$$\frac{\text{Field Acres/Hectares}}{\text{Hectares}} = \frac{\text{Total Acres/Hectares of Planted Cropland}}{\text{Hectares}}$$

$$\frac{\text{Treated Acres/Hectares}}{\text{Hectares}} = \frac{\text{Field Acres/Hectares}}{\text{Hectares}} \times \frac{\text{Band Width}}{\text{Row Spacing}}$$

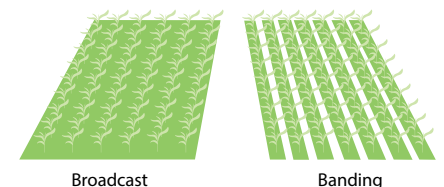



# PRESSURE DROP THROUGH SPRAYER COMPONENTS

COMPONENT NUMBER	TYPICAL PRESSURE DROP (PSI) AT VARIOUS FLOW RATES (GPM)																						
	0.5 GPM	1.0 GPM	2.0 GPM	3.0 GPM	4.0 GPM	5.0 GPM	6.0 GPM	7.0 GPM	8.0 GPM	9.0 GPM	10 GPM	15 GPM	18 GPM	24 GPM	32 GPM	48 GPM	64 GPM	75 GPM	100 GPM	125 GPM	150 GPM	200 GPM	
AA2 GunJet		0.2	0.9	2.0	3.4	5.3	7.3	10.0	13.0	16.0													
AA18 GunJet		0.6	2.2	5.0	8.3	13.0	18.4	25.0	33.0	40.0													
AA30L GunJet		0.6	2.2	5.0	9.0	14.0	20.2	27.5															
AA43 GunJet				0.4	0.6	1.0	1.5	2.0	2.6	3.3	4.1	9.2	13.2										
AA143 GunJet				0.3	0.6	0.9	1.3	1.7	2.2	2.8	3.5	7.9	11.3										
AA6B Valve				0.3	0.6	0.9	1.3	1.7	2.2	2.8	3.5	7.8	11.3	20.0									
AA17 Valve			0.2	0.5	0.8	1.3	1.8	2.5	3.2	4.1	5.0	11.3	16.2	28.8									
AA144A/144P Valve			0.2	0.5	0.8	1.3	1.8	2.5	3.2	4.1	5.0	11.3	16.2	28.8									
AA144A-1-3/AA144P-1-3 Valve			0.3	0.7	1.3	2.0	2.8	3.8	5.0	6.3	7.8	17.6	25.3										
AA145H Valve				0.2	0.4	0.6	0.8	1.1	1.4	1.8	2.2	5.0	7.2	12.8	22.8								
344 2-way Valve								0.2	0.3	0.4	0.5	1.1	1.6	2.8	5.0	11.3	20.0	27.5					
344 3-way Valve						0.2	0.3	0.4	0.6	0.7	0.9	2.0	2.8	5.0	8.9	20.0	35.6						
346 2-way Valve												0.1	0.2	0.3	0.5	1.2	2.0	2.8	5.0	7.8	11.3	20.0	
346 3-way Valve												0.3	0.4	0.7	1.3	2.8	5.0	6.9	12.2	19.1	27.5		
356 Valve												0.1	0.2	0.3	0.5	1.2	2.0	2.8	5.0	7.8	11.3	20.0	
430 2-way* Manifold			0.1	0.3	0.6	0.9	1.3	1.8	2.3	3.0	3.7	8.2	11.8	21.0									
430 3-way* Manifold			0.1	0.3	0.6	0.9	1.3	1.8	2.3	3.0	3.7	8.2	11.8	21.0									
430 FB* Manifold			0.2	0.5	0.9	1.5	2.1	2.9	3.8	4.8	5.9	13.3	19.1										
440* Manifold						0.2	0.3	0.4	0.5	0.6	0.7	1.7	2.4	4.3	7.6	17.0	30.3						
450* Manifold						0.1	0.2	0.2	0.3	0.4	0.5	1.1	1.6	2.8	5.0	11.3	20.0	27.5					
450 FB* Manifold						0.1	0.2	0.2	0.3	0.4	0.5	1.1	1.6	2.8	5.0	11.3	20.0	27.5					
460 2-way* Manifold						0.2	0.3	0.4	0.5	0.6	0.8	1.8	2.6	4.6	8.2	18.4	32.8						
460 3-way* Manifold						0.2	0.3	0.4	0.5	0.6	0.8	1.8	2.6	4.6	8.2	18.4	32.8						
460 FB* Manifold						0.2	0.3	0.4	0.6	0.7	0.9	2.0	2.8	5.0	8.9	20.0	35.6						
490* Manifold												0.1	0.2	0.3	0.5	1.2	2.0	2.8	5.0	7.8	11.3	20.0	
530A 2-Way Manual & Electric Manifold*			0.2	0.3	0.6	0.9	1.4	1.9	2.4	3.1	3.8	8.5	12.2	21.8	38.7								
530A 3-Way Manual & Electric Manifold*			0.3	0.7	1.3	2.0	2.8	3.8	5.0	6.3	7.8	17.6	25.3										
530A FB Electric Manifold*			0.4	0.9	1.6	2.6	3.7	5.0	6.5	8.3	10.2	23.0	33.1										
540* Manifold						0.2	0.2	0.3	0.4	0.6	0.7	1.5	2.2	4.0	7.0	15.8	28.1						
QJ300 Nozzle Body	0.1	0.4	1.6	3.7	6.5	10.2	14.7	20.0															
QJ360C Nozzle Body	0.2	1.0	4.0	8.9	15.8	24.7																	
QJ360E Nozzle Body	0.6	2.2	8.9	20.0	35.6																		
QJ360F Nozzle Body	0.1	0.4	1.7	3.9	6.9	10.8	15.6	21.2	27.7	35.0													
QJ373	0.2	0.7	3.0	6.7	11.8	18.5	26.6	36.2															
QJ375	0.2	0.9	3.5	7.8	13.9	21.7	31.3																
QJ380 Nozzle Body	0.1	0.6	2.2	5.0	8.9	13.9	20.0	27.2	35.6														
QJ380F Nozzle Body	0.1	0.2	1.0	2.2	4.0	6.2	8.9	12.1	15.8	20.0	24.7												
24230A/24216A Nozzle Body	0.5	2.0	7.8	17.6	31.3																		
QJ17560A Nozzle Body	0.2	1.0	4.0	8.9	15.8	24.7																	
AA122-1/2 Line Strainer				0.3	0.6	0.9	1.3	1.7	2.2	2.8	3.5	7.8	11.3	20.0									
AA122-3/4 Line Strainer				0.2	0.3	0.5	0.7	1.0	1.3	1.6	2.0	4.4	6.3	11.3	20.0								
AA122-QC Line Strainer				0.1	0.2	0.4	0.6	0.8	1.0	1.3	1.5	3.5	5.0	8.9	15.8	35.6							
AA126-3 Line Strainer						0.2	0.3	0.5	0.6	0.8	0.9	2.1	3.1	5.4	9.7	21.8							
AA126-4/F50/M50 Line Strainer								0.2	0.3	0.3	0.4	0.9	1.3	2.4	4.2	9.4	16.7	23.0					
AA126-5 Line Strainer												0.3	0.5	0.8	1.5	3.3	5.9	8.1	14.4	22.4			
AA126-6/F75 Line Strainer												0.2	0.3	0.5	0.9	1.9	3.5	4.7	8.4	13.2	19.0		

\*Manifold pressure drop data based on a single valve. Quantity of valves, inlet fitting size and inlet feed setup may affect pressure drop rating. Please contact your local TeeJet sale representative for additional information.

It is essential to know the amount of area that you intend to cover when applying a pesticide or fertilizer. Turf areas such as home lawns and golf course greens, tees and fairways should be measured in square feet or acres, depending upon the units needed.

## RECTANGULAR AREAS

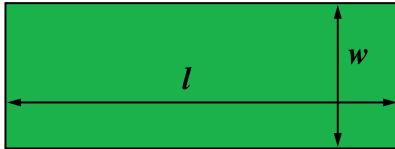

$$\text{Area} = \text{Length } (l) \times \text{Width } (w)$$



### EXAMPLE

What is the area of a lawn that is 300 feet long and 150 feet wide?

$$\text{Area} = 300 \text{ feet} \times 150 \text{ feet} = 45,000 \text{ square feet}$$

By using the following equation, it is possible to determine the area in acres.

$$\text{Area in acres} = \frac{\text{Area in square feet}}{43,560 \text{ sq ft per acre}}$$

(There are 43,560 square feet in an acre.)



### EXAMPLE

$$\begin{aligned} \text{Area in acres} &= \frac{45,000 \text{ sq ft}}{43,560 \text{ sq ft per acre}} \\ &= 1.03 \text{ acres} \end{aligned}$$

## TRIANGULAR AREAS

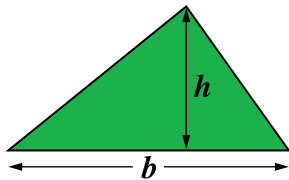

$$\text{Area} = \frac{\text{Base } (b) \times \text{Height } (h)}{2}$$



### EXAMPLE

The base of a corner lot is 250 feet while the height is 50 feet. What is the area of the lot?

$$\begin{aligned} \text{Area} &= \frac{250 \text{ feet} \times 50 \text{ feet}}{2} \\ &= 6,250 \text{ square feet} \end{aligned}$$

$$\begin{aligned} \text{Area in acres} &= \frac{6,250 \text{ square feet}}{43,560 \text{ sq ft per acre}} \\ &= 0.14 \text{ acre} \end{aligned}$$

## CIRCULAR AREAS

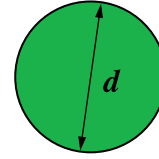

$$\begin{aligned} \text{Area} &= \frac{\pi \times \text{Diameter}^2 (d)}{4} \\ \pi &= 3.14159 \end{aligned}$$



### EXAMPLE

What is the area of a green that has a diameter of 45 feet?

$$\begin{aligned} \text{Area} &= \frac{\pi \times (45 \text{ feet})^2}{4} = \frac{3.14 \times 2025}{4} \\ &= 1,590 \text{ square feet} \end{aligned}$$

$$\begin{aligned} \text{Area in acres} &= \frac{1,590 \text{ square feet}}{43,560 \text{ sq ft per acre}} \\ &= 0.04 \text{ acre} \end{aligned}$$

## IRREGULAR AREAS

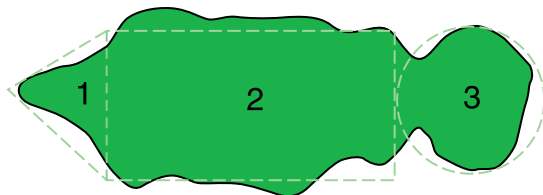

Any irregularly shaped turf area can usually be reduced to one or more geometric figures. The area of each figure is calculated and the areas are then added together to obtain the total area.



### EXAMPLE

What is the total area of the Par-3 hole illustrated above?

The area can be broken into a triangle (area 1), a rectangle (area 2) and a circle (area 3). Then use the previously mentioned equations for determining areas to find the total area.

$$\text{Area 1} = \frac{25 \text{ feet} \times 30 \text{ feet}}{2} = 375 \text{ square feet}$$

$$\text{Area 2} = 25 \text{ feet} \times 475 \text{ feet} = 11,875 \text{ square feet}$$

$$\text{Area 3} = \frac{3.14 \times (45 \text{ feet})^2}{4} = 1,590 \text{ square feet}$$

$$\text{Total Area} = 375 + 11,875 + 1,590 = 13,840 \text{ square feet}$$

$$\begin{aligned} &= \frac{13,840 \text{ square feet}}{43,560 \text{ sq ft per acre}} = 0.32 \text{ acre} \end{aligned}$$



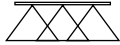

## BROADCAST APPLICATION

Sprayer calibration (1) readies your sprayer for operation and (2) diagnoses tip wear. This will give you optimum performance of your TeeJet tips.

### Equipment Needed:

- TeeJet Calibration Container
- Calculator
- TeeJet Cleaning Brush
- One new TeeJet Spray Tip matched to the tips on your sprayer
- Stopwatch or wristwatch with second hand

## STEP NUMBER 1



### Check Your Tractor/Sprayer Speed!

Knowing your real sprayer speed is an essential part of accurate spraying. Speedometer readings and some electronic measurement devices can be inaccurate because of wheel slippage. Check the time required to move over a 100- or 200-foot strip on your field. Fence posts can serve as permanent markers. The starting post should be far enough away to permit your tractor/sprayer to reach desired spraying speed. Hold that speed as you travel between the “start” and “end” markers. Most accurate measurement will be obtained with the spray tank half full. Refer to the table on page 184 to calculate your real speed. When the correct throttle and gear settings are identified, mark your tachometer or speedometer to help you control this vital part of accurate chemical application.

## STEP NUMBER 2

$$A = \frac{B+C}{D} \quad \text{The Inputs}$$

<b>Before spraying, record the following:</b>	<b>EXAMPLE:</b>
Spray tip type on your sprayer.....	TT11004 Flat Spray Tip (All tips must be identical)
Recommended application volume.....	20 GPA (From manufacturer's label)
Measured sprayer speed .....	6 MPH
Tip spacing .....	20 inches



## STEP NUMBER 3

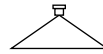

### Calculating Required Nozzle Output



Determine GPM tip output from formula.

$$\text{FORMULA: } \text{GPM} = \frac{\text{GPA} \times \text{MPH} \times \text{W}}{5,940 \text{ (constant)}}$$

$$\text{EXAMPLE: } \text{GPM} = \frac{20 \times 6 \times 20}{5,940} = \frac{2,400}{5,940}$$

**ANSWER:** 0.404 GPM

## STEP NUMBER 4



### Setting the Correct Pressure

Turn on your sprayer and check for leaks or blockage. Inspect and clean, if necessary, all tips and strainers with TeeJet brush. Replace one tip and strainer with an identical new tip and strainer on sprayer boom.

Check appropriate tip selection table and determine the pressure required to deliver the tip output calculated from the formula in Step 3 for your new tip. Since all of the tabulations are based on spraying water, conversion factors must be used when spraying solutions that are heavier or lighter than water (see page 185).

**EXAMPLE:** (Using above inputs) refer to TeeJet table on page 17 for TT11004 flat spray tip. The table shows that this spray tip delivers 0.40 GPM at 40 PSI.

Turn on your sprayer and adjust pressure. Collect and measure the volume of the spray from the new tip for one minute in the collection jar. Fine tune the pressure until you collect 0.40 GPM.

You have now adjusted your sprayer to the proper pressure. It will properly deliver the application rate specified by the chemical manufacturer at your measured sprayer speed.

## STEP NUMBER 5



### Checking Your System

**PROBLEM DIAGNOSIS:** Now, check the flow rate of a few tips on each boom section. If the flow rate of any tip is 10% greater or less than that of the newly installed spray tip, recheck the output of that tip. If only one tip is faulty, replace with new tip and strainer and your system is ready for spraying. However, if a second tip is defective, replace all tips on the entire boom. This may sound unrealistic, but two worn tips on a boom are ample indication of tip wear problems. Replacing only a couple of worn tips invites potentially serious application problems.



### Banding and Directed Applications

The only difference between the above procedure and calibrating for banding or directed applications is the input value used for “W” in the formula in Step 3.

For single tip banding or boomless applications:

$$W = \text{Sprayed band width or swath width (in inches).}$$

For multiple nozzle directed applications:

$$W = \text{Row spacing (in inches) divided by the number of tips per row.}$$

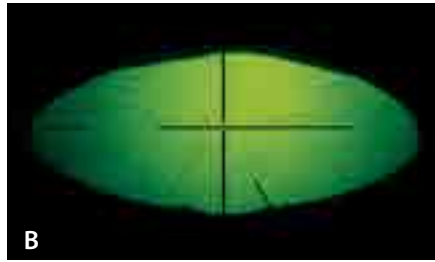
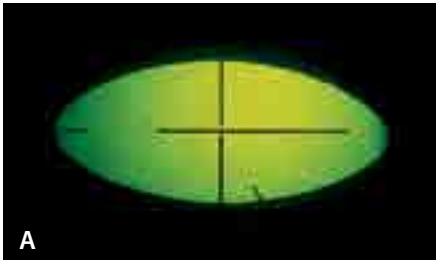

**TIPS DON'T LAST FOREVER!**

There is sufficient evidence that spray tips may be the most neglected component in today's farming. Even in countries with obligatory sprayer testing, spray tips are the most significant failure. On the other hand, they are among the most critical of items in proper application of valuable agricultural chemicals.

Using slightly worn tips is very costly. Water, pesticides, and labor are wasted and pesticide application quality can be compromised.

**AN INSIDE LOOK AT NOZZLE ORIFICE WEAR AND DAMAGE**

While wear may not be detected when visually inspecting a tip, it can be seen when viewed through an optical comparator. The edges of the worn tip (B) appear more rounded than the edges of the new tip (A). Damage to tip (C) was caused by improper cleaning. The spraying results from these tips can be seen in the illustrations below.

**DETERMINING TIP WEAR**

The best way to determine if a spray tip is excessively worn is to compare the flow rate from the used tip to the flow rate of a new tip of the same size and type. Charts in this catalog indicate the flow rates for new tips. Check the flow of each tip by using an accurate graduated collection container, a timing device and an accurate pressure gauge mounted at the nozzle body tip. Compare the flow rate of the old tip to that of the new one. Spray tips are considered excessively worn and should be replaced when their flow exceeds the flow of a new tip by 10%. Reference page 189 for more information.

**SPRAY TIP CARE IS THE FIRST STEP TO SUCCESSFUL APPLICATION**

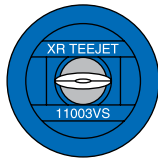

The successful performance of a crop protection product is highly dependent on its proper application as recommended by the product manufacturer. Proper selection and operation of spray nozzles are very important steps in accurate product application. The volume of spray passing through each nozzle plus the droplet size and spray distribution on the target can influence pest control.

Critical in controlling these three factors is the spray nozzle orifice. Careful craftsmanship goes into the precision

manufacturing of each nozzle orifice. ISO standards and European standards require very small flow tolerances of new nozzles (+/-5%) of nominal flow. Many TeeJet spray tip types and sizes are already JKI-approved, which confirms the high quality standard designed into TeeJet nozzles. To maintain the quality in practical spraying as long as possible, the operator's job is the proper maintenance of those spray tips.

The illustration below compares the spraying results obtained from well-maintained vs. poorly-maintained spray tips. Poor spray distribution can be prevented. Selection of longer wearing tip materials or frequent replacement of tips from softer materials can eliminate misapplication due to worn spray tips.

Careful cleaning of a clogged spray tip can mean the difference between a clean field and one with weed streaks. Flat spray tips have finely crafted thin edges around the orifice to control the spray. Even the slightest damage from improper cleaning can cause both an increased flow rate and poor spray distribution. Be sure to use adequate strainers in your spray system to minimize clogging. If a tip does clog, only use a soft bristled brush to clean it—never use a metal object. Use extreme care with soft tip materials such as plastic. Experience has shown that even a wooden toothpick can distort the orifice.

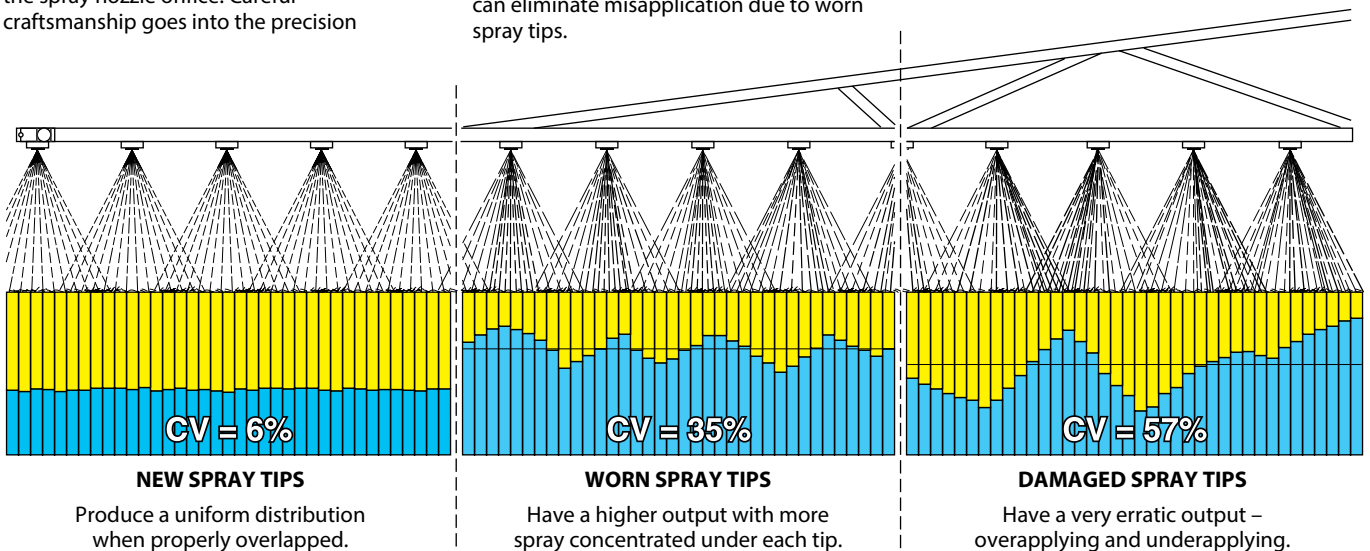

TECHNICAL INFORMATION

One of the most overlooked factors that can dramatically influence the effectiveness of a given crop production product is spray distribution. The uniformity of the spray distribution across the boom or within the spray swath is an essential component of achieving maximum product effectiveness with minimal cost and minimal non-target contamination. It is critical that carrier and product rates are applied at the recommended minimum rate. There are many other factors influencing a crop production product's effectiveness, such as weather, application timing, active ingredient rates, pest infestation, etc. However, an operator must become aware of spray distribution quality if maximum efficiency is expected.

## MEASUREMENT TECHNIQUES

Spray distribution can be measured in different ways. TeeJet Technologies and some sprayer manufacturers, as well as other research and testing stations, have patternators (spray tables) that collect the spray from tips on a standardized or real boom. These patternators have several channels aligned perpendicular to the spray tip, according to the standard ISO 5682-1.

The channels carry the spray liquid into vessels for measuring and analysis (see photo with TeeJet patternator). Under controlled conditions, very accurate distribution measurements can be made for tip evaluation and development. Distribution measurements can also take place on an actual farm sprayer. For static measurements along with the sprayer boom, a patternator equal or very similar to the one described earlier is placed under

the boom in a stationary position or as a small patternator unit scanning the whole boom up to a width of 164'. Any system of patternator measures electronically the quantity of water in each channel and calculates the values. A distribution quality test gives the applicator important information about the state of the tips on the boom. When much more detailed information about spray quality and coverage is required, a dynamic system—spraying a tracer (dye)—can be used. The same is true if the distribution within the swath on a boom must be measured.

Most of the distribution measuring devices result in data points representing the sprayer's boom swath uniformity. These data points can be very revealing just through visual observation. However, for comparison reasons, a statistical method is widely accepted. This method is Coefficient of Variation (CV). The CV compiles all the patternator data points and summarizes them into a simple percentage, indicating the amount of variation within a given distribution. For extremely uniform distributions under accurate conditions, the calculated CV shall not exceed 10%, according to the ISO 16122-2. As some European countries have stricter CV (e.a. JKI requires a CV lower than 7%) and may require the sprayer's distribution to be tested for uniformity after a certain time. These types of stipulations emphasize the great importance of distribution quality and its effect on crop protection products effectiveness.

TeeJet precisely produces spray tips that match up with the most restrictive requirements in these European countries.

## FACTORS AFFECTING DISTRIBUTION

There are a number of factors contributing to the distribution quality of a spray boom or resulting CV percentage. During a static measurement, the following factors can significantly affect the distribution.

- Spray Tips
  - type
  - pressure
  - spacing
  - spray angle
  - offset angle
  - spray pattern quality
  - flow rate
  - overlap
- Boom Height
- Worn Tips
- Pressure Losses
- Plugged Strainers
- Plugged Tips
- Plumbing Factors Influencing Liquid Turbulence at the Tip

Additionally, in the field during the spraying application or during a dynamic distribution test, the following can influence the distribution quality:

- Boom Stability
  - vertical movement (pitch)
  - horizontal movement (yaw)
- Environmental Conditions
  - wind velocity
  - wind direction
- Pressure Losses (sprayer plumbing)
- Sprayer Speed and Resulting Turbulence

The effect of distribution uniformity on the efficiency of a crop protection product can vary under different circumstances. The crop protection product itself can have a dramatic influence over its efficiency.

Consult the manufacturer's product label or recommendation before spraying.



A spray tip pattern is made up of numerous spray droplets of varying sizes. Droplet size refers to the diameter of an individual spray droplet. Droplet sizes are usually measured in microns (micrometers -  $\mu\text{m}$ ). One micron equals 0.00003937 inches; there are 25,400 microns in one inch. The micron is a useful unit of measurement because it is small enough that whole numbers can be used in droplet size measurement.

Since most tips provide a range of droplet sizes (otherwise known as droplet size distribution), it is useful to summarize this with statistical analysis. Advanced droplet size measuring devices are automated, using computers and high-speed illumination sources such as lasers to analyze thousands of droplets in a few seconds. TeeJet Technologies uses the most innovative laser measuring instrumentation to characterize sprays, obtaining droplet size and other important information, such as  $DV_{0.1}$ ,  $DV_{0.5}$  (or VMD),  $DV_{0.9}$ , percentage of driftable fines, and relative span which are used to classify droplet size and the quality of droplets produced by a given spray tip.

Since the smaller droplets have a greater tendency to move off-target, it makes sense to determine what the percentage of small droplets is for a particular spray tip to minimize it when drift is a concern. Droplets below 150 microns are considered potential drift contributors.

The table to the right shows several tips and their percentage of driftable fines.



## DRIFTABLE FINES

NOZZLE TYPE (0.5 GPM CAPACITY)	APPROXIMATE PERCENTAGE OF SPRAY VOLUME LESS THAN 150 MICRONS	
	20 PSI	40 PSI
XR – Extended Range TeeJet® (110°)	18%	29%
TTJ60 – Turbo TwinJet® (110°)	8%	14%
TT – Turbo TeeJet® (110°)	7%	16%
TF – Turbo FloodJet®	5%	9%
AIXR – Air Induction XR TeeJet® (110°)	4%	9%
AITTJ60 – Air Induction Turbo TwinJet® (110°)	2%	3%
AI – Air Induction TeeJet® (110°)	5% (@ 30 PSI)	7%
TTI60 – Turbo TeeJet® Induction TwinJet® (110°)	2%	4%
TTI – Turbo TeeJet® Induction (110°)	<1%	2%
APTJ – AccuPulse® TwinJet® (110°)	<1%	1%

Data obtained from Oxford VisiSizer system, spraying water at 70°F under laboratory conditions.

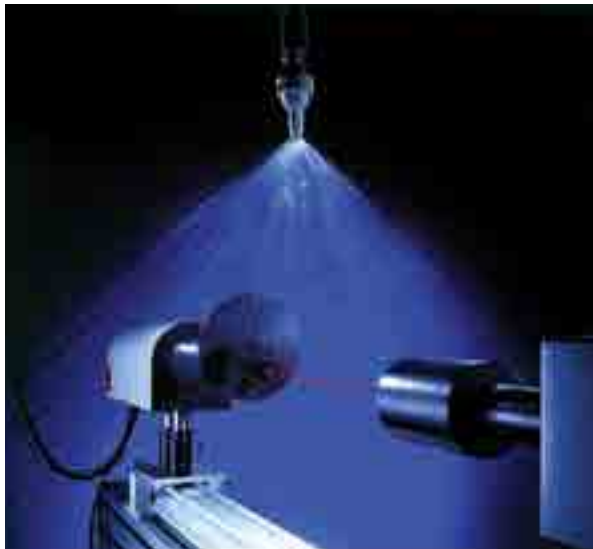





Figure 1. This is not what crop protection should look like!

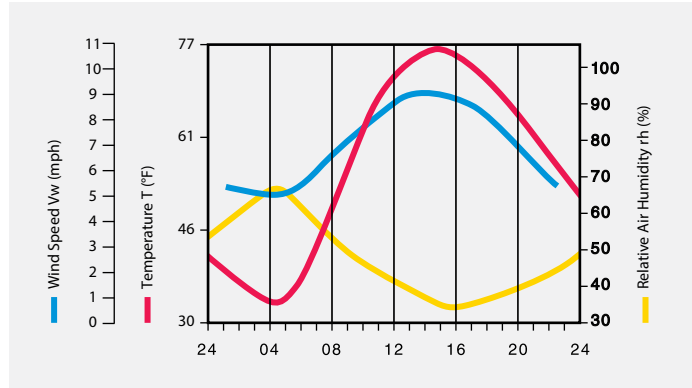

Figure 2. Development of wind speed, air temperature and relative air humidity (example). From: Malberg

When applying crop protection products, spray drift is defined as the movement and deposition of spray particles through the air to non-target locations. The two forms of spray drift are particle drift and vapor drift. Particle drift can occur during or after a crop protection product application, which results from droplets physically moving to non-target locations via air currents. It is more related to the application technology choices, such as spray tip selection and sprayer calibration. Vapor drift of the active ingredient occurs right after the crop protection product application and the crop protection product vapor reaches non-target locations. It is dependent on the crop protection product physicochemical characteristics when it has a greater trend to volatilize. Weather conditions, such as low relative humidity and high temperatures directly impact vapor drift.

The smaller the droplet, the greater the drift potential. Droplets most prone to drift are those with a diameter that is less than 150 µm and easily move off the target area by wind or other climatic conditions. Drift can cause crop protection products to be deposited in undesirable areas with serious consequences, such as:

- Damage to sensitive adjoining crops.
- Surface water contamination.
- Health risks for animals and people.
- Possible contamination to the target area and adjacent areas or possible overapplication within the target area.

## CAUSES OF SPRAY DRIFT

Several variables contribute to spray drift; these are predominantly due to the spray equipment system and meteorological factors.

### • DROPLET SIZE

Within the spray equipment system, droplet size is the most influential factor related to drift.

When a liquid solution is sprayed under pressure it is atomized into droplets of varying sizes: **The smaller the spray tip size and the greater the spray pressure, the smaller the droplets and therefore the greater the proportion of driftable droplets.**

### • SPRAY HEIGHT

As the distance between the spray tip and the target area increases, the greater impact wind speed can have on drift. The influence of wind can increase the proportion of smaller droplets being carried off target and considered drift.

Do not spray at greater heights than those recommended by the spray tip manufacturer, while taking care not to spray below the minimum recommended heights.

### • OPERATING SPEED

Increased operating speeds can cause the spray to be diverted back into upward wind currents and vortexes behind the sprayer, which traps small droplets and can contribute to drift.

**Apply crop protection products according to good, professional practices at maximum operating speeds of 6 to 10 MPH (up to 10 MPH). As wind velocities increase, reduce operating speed.\***

\* Liquid fertilizer applications using the TeeJet® tips with very coarse droplets can be performed at higher operating speeds.

### • WIND SPEED

Among the meteorological factors affecting drift, wind speed has the greatest impact. Increased wind speeds cause increased spray drift. It is common knowledge that in most parts of the world the wind speed is variable throughout the day (see Figure 2). Therefore, it is important for spraying to take place during the relatively calm hours of the day. The early

morning and early evening are usually the calmest. However, wind speed below 3 MPH can be an indicator of air instability, such as temperature inversion, resulting in drift. Ideally, winds should be in the range of 3 to 9 MPH, and crop protection products should not be sprayed when winds exceed 10 MPH. Check the product label for more information.

Wind measurements should be taken throughout the spraying operation with a wind meter or anemometer. As the risk of spray drift increases, selecting tips designed to produce coarser droplets that are less prone to drift is extremely important, such as spray tips with air induction AIXR, AITTJ60, AI, TT160, and TT1.

### • AIR TEMPERATURE AND RELATIVE HUMIDITY

Air temperature and relative humidity directly influence droplet evaporation. Finer droplets are also more vulnerable to high temperatures and low relative humidity conditions, and when compared to coarser droplets, they are less likely to reach the target.

**High temperature during the spraying application may necessitate system changes, such as tips that produce a coarser droplet or suspending spraying.**

### • CROP PROTECTION PRODUCTS AND CARRIER VOLUME

Before applying crop protection products, the applicator should read and follow all instructions provided by the manufacturer.

Since extremely low carrier volume usually necessitates the use of small tip sizes, the drift potential is increased. As high a carrier volume as practical is recommended.

## SPRAY TIPS FOR DRIFT REDUCTION

Drift potential can be minimized even when it is necessary to use small tip capacities by selecting tip types that produce larger droplets (bigger Volume Median Diameter (VMD) and a lower percentage of small droplets).

Figure 3 is an example showing VMD's produced by tips of identical flow rates (0.5 capacity) at the optimum pressure ranges for the individual tips. Within the presented tips, XR produces the smaller droplets followed by TTJ60/TT, AIXR, AITTJ60, AI, TTI60/TTI, and APTJ. TTI, TTI60, and APTJ tips produce the coarsest droplet size spectrum of this group and provide the maximum drift control, producing less than 2% of driftable fines.

Looking at individual spray tips, the greater the operational pressure, the smaller the formed droplet, and the greater the drift potential. Understanding this concept, it is possible to affirm that for all tips is possible to reduce drift at lower pressure and achieve better coverage at higher pressures. However, if just by reducing the operating pressure the droplet size and the percentage of driftable fines are still above the limit for a safe application, the user must select a spray tip that produces coarser droplets.

For example, a self-propelled sprayer operating with a ground speed of 10 MPH, tip spacing of 20", and an application rate of 15 GPA would need a tip with a capacity of 0.5 GPM, which all tips presented on Figure

3 would be able to apply at 40 PSI. However, the VMD increases significantly from the XR to the TTI/TTI60/APTJ, from fine to ultra coarse droplet size. For a contact fungicide application, a TTJ60 would be a good fit while an AIXR or AITTJ60 would be a better fit for an herbicide application. Therefore, for applicators to select the correct spray tip size it is necessary to consider the droplet size and spray pressure at which a crop protection product is most effective according to the label.

With this, they simply must reduce pressure and ground speed to reduce spray drift or even comply with statutory buffer zone requirements.

While the classic XR TeeJet orifice provides two functions; metering the volume flow rate and distributing and creating the droplets, all other spray tip types discussed above use a pre-orifice for metering while droplet creation and distribution take place at the exit orifice (Figure 4). Both functions and devices relate to each other with respect to geometry and spacing and interact with respect to the droplet size produced. The TT, TTJ60, AITTJ60, TTI60, and TTI tips force the liquid to change direction after it has passed the pre-orifice, forcing it into a horizontal chamber and to change direction again into the nearly vertical passage in the orifice itself. The AIXR, AI, AITTJ60, TTI60, and TTI air induction tips operate on the Venturi principle, where the pre-orifice generates a higher-velocity stream, aspirating air through the side holes. This specific air/liquid mix creates more coarse

droplets that are filled with air, depending on the crop protection product used.

APTJ is a non-air induction tip, that produced highly drift-resistant droplet due do its patent-pending recirculating design.

## SUMMARY

Successful drift management centers on sound knowledge about drift contributing factors and the use of drift control TeeJet spray tips. To strike a sound balance between successful crop protection products application and environmental protection, applicators should use approved broadcast TeeJet spray tips that are classified as drift control and operate these within the pressure ranges that ensure product effectiveness (i.e., set spray tips to 50% drift control or less).

The following list shows all the relevant factors that need to be considered, optimized, or applied to achieve effective drift control:

- Low-Drift TeeJet spray tips
- Spraying pressure and droplet size
- Application rate and tip size
- Spraying height
- Forward speed
- Wind speed
- Ambient temperature and relative humidity
- Buffer zones (or apply options that allow reducing the width of buffer strips)
- Compliance with manufacturer instructions

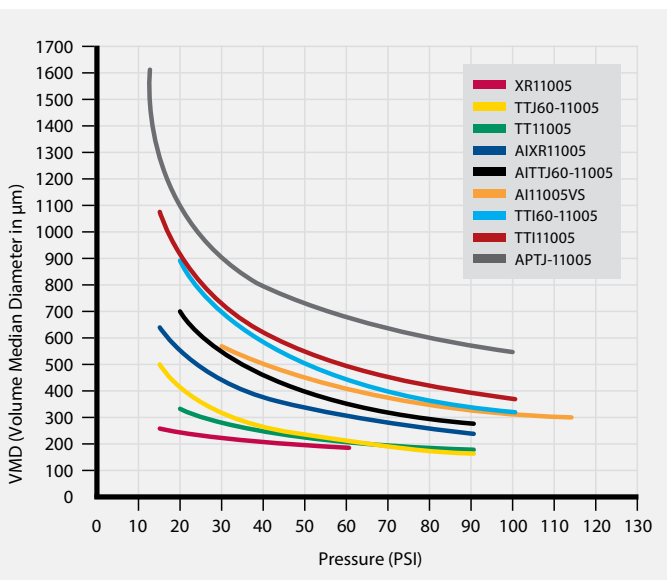

**Figure 3.** Volumetric droplet diameters of XR, TT, TTJ60, AIXR, AI, AITTJ60, TTI60, TTI, and APTJ spray tips relative to pressure.

### Measurement Conditions:

- Continuous Oxford Laser measurement across the full width of the flat spray
- Water temperature 70°F under laboratory conditions

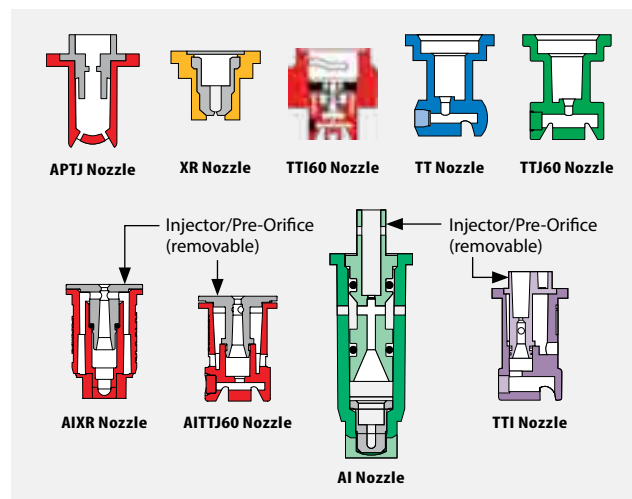

**Figure 4.** APTJ, XR, TT, TTJ60, AIXR, AITTJ60, AI, TTI60, and TTI spray tips cross-section view.



## ASSESSMENT OF NOZZLE DRIFT CONTROL IN EUROPE

In times of hard discussions regarding environmental protection, the drift control of the spray tips and spray systems became a very important topic in most of the European countries and mandatory in the Nord, West, and Middle Europe. Ones with the implementation of the European Green Deal, it's expected that the South and East parts of Europe will align at the same standards.

Drift reduction is not a new topic. Preliminary assessment criteria for drift control during by crop protection products applications were first defined in the 1980's and 1990's. With the XR TeeJet® spray tips and the first generation of drift control spray tips (DG TeeJet®), TeeJet achieved significant advances in crop protection technology at that time. However, stricter rules for buffer zones to protect sensitive areas have led to the development of a program that assesses spray tip drift reduction, as well as innovative spray tip designs (AI TeeJet) producing larger droplet sizes by maintaining perfect coverage.

The testing institutes from Germany, the United Kingdom, France, and the Netherlands have different standardized assessments for measuring drift reduction. The Julius Kühn Institute-Federal Research Institute (JKI) standards and results are accepted by most of the European countries in the national approval process.

The countries mentioned above have compiled corresponding percentage drift control categories, which vary from one to another in some areas. While in Germany and Netherlands drift control is categorized as 50% / 75% / 90% / 95%, in the United Kingdom they are categorized as 2 star\*\*, 3 star\*\*\*, and 4 star\*\*\*\*, and 66% in France. Furthermore, the same spray tip type and size operated at the same pressure can have a different category of drift reduction in different countries that use different assessments to evaluate drift control.

Drift reduction ratings are currently mandatory in some countries like Germany, Netherlands, France, Belgium, Denmark, and the United Kingdom, while in other countries the drift reduction is only a recommendation to assist farmers in selecting a tip that is more suitable for their applications.

As TeeJet Technologies is present in all European countries, all new spray tips are tested and have them assessed in each of these countries to verify the effectiveness of the technical advances so farmers can use our company products without fearing conflict with the government.

### THE SYSTEM IN GERMANY

In Germany, the Julius Kühn Institute-Federal Research Institute for Cultivated Plants (JKI), is responsible for testing nozzles for agricultural use. Drift measurements are taken for standard spray tips (110–120°, symmetric pattern, 50 cm spacing) in the wind tunnel, using vertical collectors and the "DIX model" (Drift Potential Index), which gives values that express the percentage of drift reduction categories. For narrow-angle spray tips, asymmetric or 25 cm spacing, the measurements take place in the field under standardized conditions for temperature, wind direction, wind speed, and forward speed.

### THE SYSTEM IN THE UNITED KINGDOM (UK)

The UK agency for the equipment certification is the Local Environmental Risk Assessments for Pesticides (LERAP). Spray application systems that have been tested regarding drift reduction in the SILSOE wind tunnel will get a "LERAP-Low Drift Star Rating" which are: 2 star\*\*, 3 star\*\*\*, and 4 star\*\*\*\*, which roughly corresponds to 50%, 75%, and 90% of drift reduction respectively.

In contrast to the JKI, the UK wind tunnel methodology records the droplets landed on horizontal collectors.

### THE SYSTEM IN THE NETHERLANDS

The local authority in NL for the spray equipment approvals is the Technical Assessment Committee (TCT), and the results of spray tips that reduce drift by 50%, 75%, 90%, and 95% are published on the DRD list. Instead of using wind tunnel systems as used at JKI and LERAP, the Wageningen University (WUR) uses a Phase Doppler Particle Analyzer (PDPA laser) to investigate droplet velocity and some parameters such as  $DV_{0,1}$ , VMD,  $DV_{0,9}$ , and volume fraction  $<100\mu\text{m}$ . The data collected is then fed into the IDEFICS model.

### THE SYSTEM IN FRANCE

In France, the tested spray tips and spray equipment are published on the official list of the Ministry of Agriculture and Food, after consulting the National Research Institute for Agriculture, Food and the Environment (INRAE). Up to now, the drift reduction requirement is 66% for applications that take place close to sensitive areas.

### BENEFITS & OPTIONS FOR USERS

The use of low drift spray tips brings significant benefits to users around the world. Depending on the location of the fields from environmentally sensitive areas such as surface water and field boundaries, applicators can reduce the width of buffer zones, as stipulated by the relevant restrictions in association with the approval of the pesticide (e.g. 20-meter no-spray buffer zone) and the national legislation. In general, for successful crop protection, it is only necessary to select spray tips with a high percentage classification for drift control in those situations where statutory buffer zone requirements apply. Otherwise, it is preferable to use nozzles at a spray pressure achieving a 50% drift control or less, depending on the application.

For further information about the low-drift categories of TeeJet spray tips, contact your TeeJet representative or go to [www.teejet.com](http://www.teejet.com).

The droplet size classification follows a strict and concise parameter, which was first created in 1985 in England by the British Crop Protection Council (BCPC). This classification system established a series of droplet size classes.

In 1999, the American Society of Agricultural and Biological Engineers (ASABE) developed a new standard for droplet size classification—ASABE S572, in which the droplet size boundaries were set by a series of defined TeeJet reference spray tips and operating pressures (ASABE, 2009). The ASABE S572 original standard established six droplet size classes (VF, F, M, C, VC, and XC), with 5 reference nozzles establishing the boundaries between them. Two additional droplet size classes were added in the same year on the review of the standard—ASABE S572.1, totaling eight classes (XF, VF, F, M, C, VC, XC, and UC).

The International Organization for Standardization (ISO) worked on the development of an international droplet size classification standard and, in 2018, the ISO 25358 standard was published (ISO, 2018), which carried out the update of some droplets size classification ranges to better distribute the classification boundaries. Only the C/VC, VC/XC, and XC/UC boundaries have changed. The new droplet size data in catalog 52 are based on this new classification standard. The ASABE has updated the standard to match with the ISO 25358 as ASABE S572.3.

Spray tip type selection is often based upon droplet size. The droplet size from a tip becomes very important when the efficacy of a particular crop protection product is dependent on coverage, or the prevention of spray drift is a priority. Most of the spray tips used in agriculture produce droplet sizes in the range of very fine to ultra coarse droplets.

Spray tips that produce droplets in the fine to the medium range are usually recommended for post-emergence contact applications,









such as fungicides and insecticides, which require excellent coverage on the intended target area. Spray tips producing medium to very coarse droplets, in general, are more recommended for systemic insecticides and contact herbicides. Spray tips producing droplets from the medium to the ultra coarse provide significantly improved drift control while offering less thorough target coverage. These spray tips are commonly used for soil applied and systemic herbicides.

It is important to remember that a given spray tip produces different droplet sizes when operating at different pressures. For example, an AIXR 11003 produces a very coarse droplet size at 30 PSI and a medium droplet size at 60 PSI.

Care must be taken when comparing the droplet size of different tips, as different droplet size standards can bias the comparison and measuring techniques.

For the latest accurate information about spray tips and their droplet size, please contact your nearest TeeJet representative.

Droplet size classes are shown in the following tables to assist in choosing an appropriate spray tip.

CATEGORY	COLOR CODE	
Extremely Fine		XF
Very Fine		VF
Fine		F
Medium		M
Coarse		C
Very Coarse		VC
Extremely Coarse		XC
Ultra Coarse		UC

Droplet size classifications are in accordance with ISO Standard 25358 at the date of printing, and its standard classification is subject to change.

## AI TEEJET® (AI EVEN)

TIP PART NO.	PSI								
	30	40	50	60	70	80	90	100	115
A195015E	XC	XC	VC	VC	VC	C	C	C	
A16502E	UC	XC	XC	VC	VC	VC	VC	C	C
A19502E	XC	XC	VC	VC	VC	C	C	C	
A165025E	UC	XC	XC	VC	VC	VC	VC	VC	C
A195025E	XC	XC	VC	VC	VC	C	C	C	
A16503E	UC	XC	XC	VC	VC	VC	VC	VC	C
A19503E	XC	XC	VC	VC	VC	C	C	C	
A16504E	UC	XC	XC	VC	VC	VC	C	C	C
A19504E	XC	XC	VC	VC	VC	C	C	C	
A16505E	UC	XC	XC	XC	VC	VC	VC	VC	VC
A19505E	XC	XC	VC	VC	VC	C	C	C	
A16506E	UC	XC	XC	XC	VC	VC	VC	VC	VC
A19506E	UC	XC	XC	VC	VC	VC	VC	C	
A19508E	UC	XC	XC	VC	VC	VC	VC	C	

## AI3070 TEEJET® (AI3070)

TIP PART NO.	PSI									
	20	25	30	35	40	50	60	70	80	90
A13070-015	XC	VC	VC	VC	VC	C	C	M	M	M
A13070-02	XC	VC	VC	VC	VC	C	C	M	M	M
A13070-025	XC	VC	VC	VC	VC	C	C	C	M	M
A13070-03	XC	XC	VC	VC	VC	VC	C	C	C	M
A13070-04	XC	XC	XC	VC	VC	VC	C	C	C	C
A13070-05	UC	XC	XC	XC	VC	VC	VC	C	C	C

## AI TEEJET® (AI)

TIP PART NO.	PSI								
	30	40	50	60	70	80	90	100	
A180015	XC	XC	VC	VC	VC	C	C	C	
A110015	XC	XC	VC	VC	C	C	C	C	
A18002	XC	XC	VC	VC	VC	VC	C	C	
A111002	XC	XC	VC	VC	C	C	C	C	
A180025	XC	XC	VC	VC	VC	VC	C	C	
A111002	XC	XC	VC	VC	C	C	C	C	
A18003	XC	XC	VC	VC	VC	VC	C	C	
A111003	XC	XC	VC	VC	C	C	C	C	
A18004	XC	XC	VC	VC	VC	VC	C	C	
A111004	XC	XC	VC	VC	C	C	C	C	
A18005	XC	XC	VC	VC	VC	VC	C	C	
A111005	XC	XC	VC	VC	VC	VC	C	C	
A18006	XC	XC	XC	VC	VC	VC	VC	VC	VC
A111006	XC	XC	VC	VC	VC	VC	C	C	
A111008	XC	XC	VC	VC	VC	VC	VC	C	

## AIC TEEJET® (AIC)

TIP PART NO.	PSI							
	30	40	50	60	70	80	90	100
AIC110015-VS	XC	XC	VC	VC	VC	C	C	C
AIC11002-VS	XC	XC	VC	VC	VC	C	C	C
AIC110025-VS	XC	XC	VC	VC	VC	C	C	C
AIC11003-VS	XC	XC	VC	VC	VC	C	C	C
AIC11004-VS	XC	XC	VC	VC	VC	C	C	C
AIC11005-VS	XC	XC	VC	VC	VC	VC	C	C
AIC11006-VS	XC	XC	VC	VC	VC	VC	C	C
AIC11008-VS	XC	XC	XC	VC	VC	VC	VC	VC
AIC11010-VS	UC	XC	XC	XC	VC	VC	VC	VC
AIC11015-VS	UC	XC	XC	XC	VC	VC	VC	VC

## ACCUPULSE® TWINJET® (APTJ)

TIP PART NO.	PSI										
	20	25	30	35	40	50	60	70	80	90	100
APTJ-110015	UC	UC	UC	UC	UC	UC	XC	XC	XC	XC	XC
APTJ-11002	UC	UC	UC	UC	UC	UC	XC	XC	XC	XC	XC
APTJ-110025	UC	UC	UC	UC	UC	UC	XC	XC	XC	XC	XC
APTJ-11003	UC	UC	UC	UC	UC	UC	XC	XC	XC	XC	XC
APTJ-11004	UC	UC	UC	UC	UC	UC	XC	XC	XC	XC	XC
APTJ-11005	UC	UC	UC	UC	UC	UC	XC	XC	XC	XC	XC
APTJ-11006	UC	UC	UC	UC	UC	UC	XC	XC	XC	XC	XC
APTJ-11008	UC	UC	UC	UC	UC	UC	XC	XC	XC	XC	XC
APTJ-11010	UC	UC	UC	UC	UC	UC	XC	XC	XC	XC	XC
APTJ-11012	UC	UC	UC	UC	UC	XC	XC	XC	XC	XC	XC

## AIR INDUCTION TURBO TWINJET® (AITTJ60)

TIP PART NO.	PSI							
	20	30	40	50	60	70	80	90
AITTJ60-11002	XC	VC	VC	C	C	C	C	M
AITTJ60-110025	XC	VC	VC	VC	C	C	C	C
AITTJ60-11003	XC	XC	VC	VC	C	C	C	C
AITTJ60-11004	XC	XC	VC	VC	C	C	C	C
AITTJ60-11005	UC	XC	VC	VC	VC	C	C	C
AITTJ60-11006	UC	XC	VC	VC	VC	C	C	C
AITTJ60-11008	UC	XC	XC	XC	VC	VC	VC	VC
AITTJ60-11010	UC	XC	XC	XC	VC	VC	VC	VC
AITTJ60-11015	UC	XC	XC	XC	VC	VC	VC	VC

## AITX CONEJET® (AITXA & AITXB)

TIP PART NO.	PSI														
	60	70	80	90	100	120	140	160	180	200	220	240	260	280	300
AITX01	XC	VC	VC	VC	VC	C	C	M	M	M	F	F	F	F	F
AITX015	XC	VC	VC	VC	VC	C	C	M	M	M	F	F	F	F	F
AITX02	XC	VC	VC	VC	VC	C	C	C	C	M	M	M	M	F	F
AITX025	XC	XC	XC	XC	VC	VC	VC	VC	C	M	M	M	M	F	F
AITX03	XC	XC	XC	XC	VC	VC	VC	VC	C	M	M	M	M	F	F
AITX04	UC	UC	XC	XC	VC	VC	VC	VC	C	C	M	M	M	M	M

## AIUB TEEJET® (AIUB)

TIP PART NO.	PSI								
	30	35	40	50	60	70	80	90	100
AIUB8502	UC	XC	XC	XC	VC	VC	VC	C	C
AIUB85025	XC	XC	XC	VC	VC	VC	C	C	C
AIUB8503	XC	XC	XC	VC	VC	VC	C	C	C
AIUB8504	XC	XC	XC	VC	VC	VC	C	C	C

## AIXR TEEJET® (AIXR)

TIP PART NO.	PSI										
	15	20	25	30	35	40	50	60	70	80	90
AIXR110015	VC	VC	C	C	C	C	M	M	M	M	M
AIXR11002	XC	VC	VC	VC	C	C	M	M	M	M	M
AIXR110025	XC	VC	VC	VC	C	C	M	M	M	M	M
AIXR11003	XC	VC	VC	VC	C	C	C	M	M	M	M
AIXR11004	XC	VC	VC	VC	VC	C	C	C	M	M	M
AIXR11005	XC	XC	VC	VC	VC	VC	C	C	C	M	M
AIXR11006	XC	XC	XC	VC	VC	VC	VC	C	C	C	C
AIXR11008	UC	XC	XC	XC	VC	VC	VC	VC	C	C	C
AIXR11010	UC	UC	XC	XC	XC	VC	VC	VC	VC	C	C

## DG TEEJET® (DG)

TIP PART NO.	PSI				
	30	35	40	50	60
DG80015	M	M	F	F	F
DG110015	M	M	M	M	F
DG8002	C	M	M	M	M
DG11002	C	C	M	M	M
DG8003	C	M	M	M	M
DG11003	C	C	M	M	M
DG8004	C	M	M	M	M
DG11004	C	C	M	M	M
DG8005	C	C	C	M	M
DG11005	C	C	C	M	M

## DROPLET SIZE CLASSIFICATION

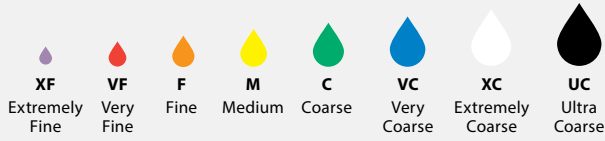

### DG TEEJET® (DG E)

TIP PART NO.	PSI				
	30	35	40	50	60
DG95015E	M	M	M	F	F
DG9502E	M	M	M	M	M
DG9503E	M	M	M	M	M
DG9504E	C	M	M	M	M
DG9505E	C	C	C	M	M

### DG TWINJET® (DGTJ60)

TIP PART NO.	PSI				
	30	35	40	50	60
DGTJ60-110015	M	M	F	F	F
DGTJ60-11002	M	M	M	M	M
DGTJ60-11003	M	M	M	M	M
DGTJ60-11004	C	C	C	M	M
DGTJ60-11006	C	C	C	M	M
DGTJ60-11008	C	C	C	M	M

### TEEJET® (TP)

TIP PART NO.	PSI				
	30	35	40	50	60
TP80005	F	F	F	VF	VF
TP110005	VF	VF	VF	VF	VF
TP800067	F	F	F	VF	VF
TP1100067	F	VF	VF	VF	VF
TP8001	F	F	F	F	VF
TP11001	F	F	F	VF	VF
TP8002	M	F	F	F	F
TP11002	F	F	F	F	F
TP8003	M	M	M	F	F
TP11003	M	F	F	F	F
TP8004	M	M	M	M	F
TP11004	M	M	F	F	F
TP8005	M	M	M	M	M
TP11005	M	M	M	M	M
TP8006	C	C	M	M	M
TP11006	M	M	M	M	M
TP8008	C	C	C	M	M
TP11008	M	M	M	M	M
TP8010	C	C	C	M	M
TP11010	M	M	M	M	M
TP8015	VC	C	C	C	C
TP11015	C	C	C	M	M
TP8020	VC	C	C	C	C
TP11020	VC	VC	C	C	C

### TEEJET (TP E)

TIP PART NO.	PSI				
	30	35	40	50	60
TP8001E	F	F	F	F	VF
TP80015E	F	F	F	F	F
TP8002E	F	F	F	F	F
TP8003E	M	M	F	F	F
TP8004E	M	M	M	M	F
TP8005E	M	M	M	M	M
TP8006E	C	M	M	M	M
TP8008E	C	C	C	M	M
TP8010E	C	C	C	M	M
TP8015E	VC	C	C	C	C
TP8020E	VC	VC	VC	C	C

### TK FLOODJET® (TK)

TIP PART NO.	PSI						
	10	15	20	25	30	35	40
TK-1	M	M	M	M	M	F	F
TK-1.5	M	M	M	M	M	M	F
TK-2	C	M	M	M	M	M	M
TK-2.5	C	M	M	M	M	M	M
TK-3	C	M	M	M	M	M	M
TK-4	C	C	C	M	M	M	M
TK-5	C	C	C	C	M	M	M
TK-7.5	VC	VC	C	C	C	C	M
TK-10	VC	VC	VC	C	C	C	C

### TURBO TEEJET® (TT)

TIP PART NO.	PSI										
	15	20	25	30	35	40	50	60	70	80	90
TT11001	VC	C	C	M	M	M	M	M	F	F	F
TT110015	VC	VC	C	C	C	M	M	M	M	F	F
TT11002	VC	VC	C	C	C	M	M	M	M	F	F
TT110025	VC	VC	C	C	C	M	M	M	M	F	F
TT11003	XC	VC	VC	C	C	M	M	M	M	F	F
TT11004	XC	VC	VC	C	C	M	M	M	M	F	F
TT11005	XC	VC	VC	C	C	M	M	M	M	F	F
TT11006	XC	VC	VC	C	C	M	M	M	M	F	F
TT11008	XC	VC	VC	VC	C	M	M	M	M	M	F
TT11010	UC	XC	XC	VC	VC	VC	C	C	C	M	M
TT11012	UC	XC	XC	XC	VC	VC	VC	VC	C	C	C

## TURBO TEEJET® INDUCTION (TTI)

TIP PART NO.	PSI									
	15	20	30	40	50	60	70	80	90	100
TTI11001	UC	UC	UC	XC	XC	VC	VC	VC	VC	C
TTI110015	UC	UC	UC	XC	XC	XC	VC	VC	VC	VC
TTI11002	UC	UC	UC	XC	XC	XC	VC	VC	VC	VC
TTI110025	UC	UC	UC	XC	XC	XC	VC	VC	VC	VC
TTI11003	UC	UC	UC	XC	XC	XC	VC	VC	VC	VC
TTI11004	UC	UC	UC	XC	XC	XC	VC	VC	VC	VC
TTI11005	UC	UC	UC	XC	XC	XC	VC	VC	VC	VC
TTI11006	UC	UC	UC	XC	XC	VC	VC	VC	VC	C
TTI11008	UC	UC	UC	XC	XC	VC	VC	VC	VC	C
TTI11010	UC	UC	UC	XC	XC	VC	VC	VC	VC	C

## TURBO FLOODJET® (TF-VP)

TIP PART NO.	PSI						
	10	15	20	25	30	35	40
TF-VP2	UC	XC	XC	VC	VC	VC	C
TF-VP2.5	UC	XC	XC	VC	VC	VC	C
TF-VP3	UC	XC	XC	XC	VC	VC	VC
TF-VP4	UC	UC	UC	XC	XC	VC	VC
TF-VP5	UC	UC	UC	XC	XC	VC	VC
TF-VP7.5	UC	UC	UC	XC	XC	VC	VC
TF-VP10	UC	UC	UC	XC	XC	VC	VC

## TURBO FLOODJET (TF-VS)

TIP PART NO.	PSI						
	10	15	20	25	30	35	40
TF-VS2	UC	UC	XC	XC	VC	VC	VC
TF-VS2.5	UC	UC	XC	XC	VC	VC	VC
TF-VS3	UC	UC	XC	XC	XC	XC	VC
TF-VS4	UC	UC	UC	XC	XC	XC	VC
TF-VS5	UC	UC	UC	XC	XC	XC	VC
TF-VS7.5	UC	UC	UC	XC	XC	XC	VC
TF-VS10	UC	UC	UC	XC	XC	XC	VC

## TTI TWINJET® (TTI60)

TIP PART NO.	PSI										
	20	25	30	35	40	50	60	70	80	90	100
TTI60-11002	UC	XC	XC	XC	XC	VC	VC	VC	C	C	C
TTI60-110025	UC	XC	XC	XC	XC	VC	VC	VC	C	C	C
TTI60-11003	UC	UC	XC	XC	XC	XC	XC	VC	VC	VC	VC
TTI60-11004	UC	UC	UC	XC	XC	XC	XC	VC	VC	VC	VC
TTI60-11005	UC	UC	UC	XC	XC	XC	XC	VC	VC	VC	VC
TTI60-11006	UC	UC	UC	UC	XC	XC	XC	VC	VC	VC	VC
TTI60-11008	UC	UC	UC	UC	XC	XC	XC	VC	VC	VC	VC

## TX CONEJET® (TX)

TIP PART NO.	PSI									
	30	40	50	60	70	80	90	100	120	
TX-1	VF	VF	VF	VF	VF	VF	VF	VF	VF	
TX-2	VF	VF	VF	VF	VF	VF	VF	VF	VF	
TX-3	VF	VF	VF	VF	VF	VF	VF	VF	VF	
TX-4	VF	VF	VF	VF	VF	VF	VF	VF	VF	
TX-6	VF	VF	VF	VF	VF	VF	VF	VF	VF	
TX-8	VF	VF	VF	VF	VF	VF	VF	VF	VF	
TX-10	F	VF	VF	VF	VF	VF	VF	VF	VF	
TX-12	F	F	VF	VF	VF	VF	VF	VF	VF	
TX-18	F	F	F	VF	VF	VF	VF	VF	VF	
TX-26	F	F	F	F	VF	VF	VF	VF	VF	

## TURFJET (TTJ)

TIP PART NO.	PSI							
	25	30	35	40	50	60	70	75
1/4TTJ02	UC	XC	XC	XC	VC	VC	VC	VC
1/4TTJ04	UC	UC	UC	UC	UC	UC	UC	UC
1/4TTJ05	UC	UC	UC	UC	UC	UC	UC	UC
1/4TTJ06	UC	UC	UC	UC	UC	UC	UC	UC
1/4TTJ08	UC	UC	UC	UC	UC	UC	UC	UC
1/4TTJ10	UC	UC	UC	UC	UC	UC	UC	UC
1/4TTJ15	UC	UC	UC	UC	UC	UC	UC	UC

## TURBO TWINJET® (TTJ60)

TIP PART NO.	PSI									
	20	30	40	50	60	70	80	90	80	90
TTJ60-11002	C	C	M	M	M	M	M	M	M	M
TTJ60-110025	VC	C	M	M	M	M	M	M	M	M
TTJ60-11003	VC	C	C	M	M	M	M	M	M	M
TTJ60-11004	VC	C	C	M	M	M	M	M	M	M
TTJ60-11005	VC	C	C	M	M	M	M	M	M	M
TTJ60-11006	VC	C	C	M	M	M	M	M	M	M
TTJ60-11008	VC	C	C	M	M	M	M	M	M	M
TTJ60-110010	VC	C	C	C	M	M	M	M	M	M

## TX CONEJET® (TXA & TXB)

TIP PART NO.	PSI									
	30	40	50	60	70	80	90	100		
TX*800050	VF	VF	VF	VF	VF	VF	VF	VF		
TX*800067	VF	VF	VF	VF	VF	VF	VF	VF		
TX*8001	F	VF	VF	VF	VF	VF	VF	VF		
TX*80015	F	VF	VF	VF	VF	VF	VF	VF		
TX*80020	F	F	VF	VF	VF	VF	VF	VF		
TX*80030	F	F	F	VF	VF	VF	VF	VF		
TX*8004	F	F	F	VF	VF	VF	VF	VF		

\*- Specify A or B



## DROPLET SIZE CLASSIFICATION

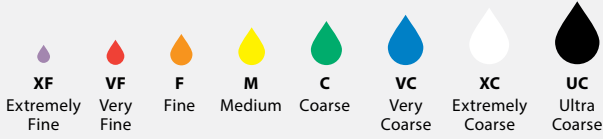

### TXR CONEJET® (TXR)

TIP PART NO.	PSI							
	30	40	50	60	70	80	90	100
TXR8000553	VF	VF	VF	VF	VF	VF	VF	VF
TXR800071	VF	VF	VF	VF	VF	VF	VF	VF
TXR80001	VF	VF	VF	VF	VF	VF	VF	VF
TXR80013	VF	VF	VF	VF	VF	VF	VF	VF
TXR80015	F	VF	VF	VF	VF	VF	VF	VF
TXR80017	F	VF	VF	VF	VF	VF	VF	VF
TXR80020	F	F	VF	VF	VF	VF	VF	VF
TXR80028	F	F	F	VF	VF	VF	VF	VF
TXR80030	F	F	F	VF	VF	VF	VF	VF
TXR80036	F	F	F	VF	VF	VF	VF	VF
TXR8004	F	F	F	VF	VF	VF	VF	VF
TXR80049	F	F	F	F	F	F	VF	VF

### TWINJET® (TJ60)

TIP PART NO.	PSI				
	30	35	40	50	60
TJ60-8001	F	F	F	VF	VF
TJ60-8002	F	F	F	F	F
TJ60-11002	F	F	F	F	F
TJ60-8003	F	F	F	F	F
TJ60-11003	F	F	F	F	F
TJ60-8004	F	F	F	F	F
TJ60-11004	F	F	F	F	F
TJ60-8005	M	M	M	M	F
TJ60-11005	M	M	M	M	F
TJ60-8006	M	M	M	M	M
TJ60-11006	M	M	M	M	M
TJ60-8008	M	M	M	M	M
TJ60-11008	M	M	M	M	M
TJ60-8010	M	M	M	M	M
TJ60-11010	M	M	M	M	M

### XR TEEJET® (XR)

TIP PART NO.	PSI					
	15	20	30	40	50	60
XR8001	F	F	F	F	F	F
XR11001	F	F	F	F	F	VF
XR80015	M	F	F	F	F	F
XR110015	M	F	F	F	F	F
XR8002	M	M	F	F	F	F
XR11002	M	M	F	F	F	F
XR80025	M	M	M	F	F	F
XR110025	M	M	M	F	F	F
XR8003	M	M	M	F	F	F
XR11003	M	M	M	F	F	F
XR80035	M	M	M	M	F	F
XR8004	M	M	M	M	F	F
XR11004	M	M	M	M	F	F
XR8005	C	M	M	M	F	F
XR11005	M	M	M	M	M	F
XR8006	C	C	M	M	M	M
XR11006	C	M	M	M	M	M
XR8008	VC	C	C	M	M	M
XR11008	C	M	M	M	M	M
XR8010	VC	C	C	M	M	M
XR11010	C	C	C	M	M	M
XR8015	XC	VC	VC	C	C	M
XR11015	VC	VC	C	C	C	M
XR11020	XC	VC	VC	C	C	C

### TWINJET® (TJ60 E)

TIP PART NO.	PSI				
	30	35	40	50	60
TJ60-8002E	F	F	F	F	F
TJ60-8003E	F	F	F	F	F
TJ60-8004E	F	F	F	F	F
TJ60-8006E	M	M	M	F	F

### XRC TEEJET® (XRC)

TIP PART NO.	PSI					
	15	20	30	40	50	60
XRC8001	F	F	F	F	F	F
XRC11001	F	F	F	F	F	VF
XRC80015	M	F	F	F	F	F
XRC110015	M	F	F	F	F	F
XRC8002	M	M	F	F	F	F
XRC11002	M	M	F	F	F	F
XRC80025	M	M	M	F	F	F
XRC110025	M	M	M	F	F	F
XRC8003	M	M	M	F	F	F
XRC11003	M	M	M	F	F	F
XRC80035	M	M	M	M	F	F
XRC8004	M	M	M	M	F	F
XRC11004	M	M	M	M	F	F
XRC8005	C	M	M	M	F	F
XRC11005	M	M	M	M	M	F
XRC8006	C	C	M	M	M	M
XRC11006	C	M	M	M	M	M
XRC8008	VC	C	C	M	M	M
XRC11008	C	M	M	M	M	M
XRC8010	VC	C	C	M	M	M
XRC11010	C	C	C	M	M	M
XRC8015	XC	VC	VC	C	C	M
XRC11015	VC	VC	C	C	C	M
XRC11020	XC	VC	VC	C	C	C

### XE TEEJET® (XE)

TIP PART NO.	PSI						
	10	15	20	30	40	50	60
XE15002	UC	UC	XC	XC	VC	VC	VC
XE15004	UC	UC	XC	XC	VC	VC	VC
XE15006	UC	UC	UC	XC	VC	VC	C
XE15008	UC	UC	UC	XC	VC	C	C

### XP BOOMJET® (XP)

TIP PART NO.	PSI				
	20	30	40	50	60
1/4XP10*	UC	UC	XC	XC	XC
1/4XP20*	UC	UC	UC	XC	XC
1/4XP25*	UC	UC	UC	XC	XC
1/2XP40*	UC	UC	UC	UC	UC
1/2XP80*	UC	UC	UC	UC	UC

\*Specify L or R

TECHNICAL INFORMATION

The following diagrams have been developed to serve as a guideline for plumbing agricultural sprayers. Similar manual valves may be substituted for electric valves. However, the sequence in which these valves occur should remain the same. Note that one of the most common causes of premature valve failure is improper installation.

**POSITIVE DISPLACEMENT PUMP**

Piston, roller and diaphragm pumps are all types of positive displacement pumps. This means that pump output is proportional to speed and virtually independent of pressure. A key component in a positive displacement system is the pressure relief valve. Proper placement and sizing of the pressure relief valve is essential for safe and accurate operation of a positive displacement pump.

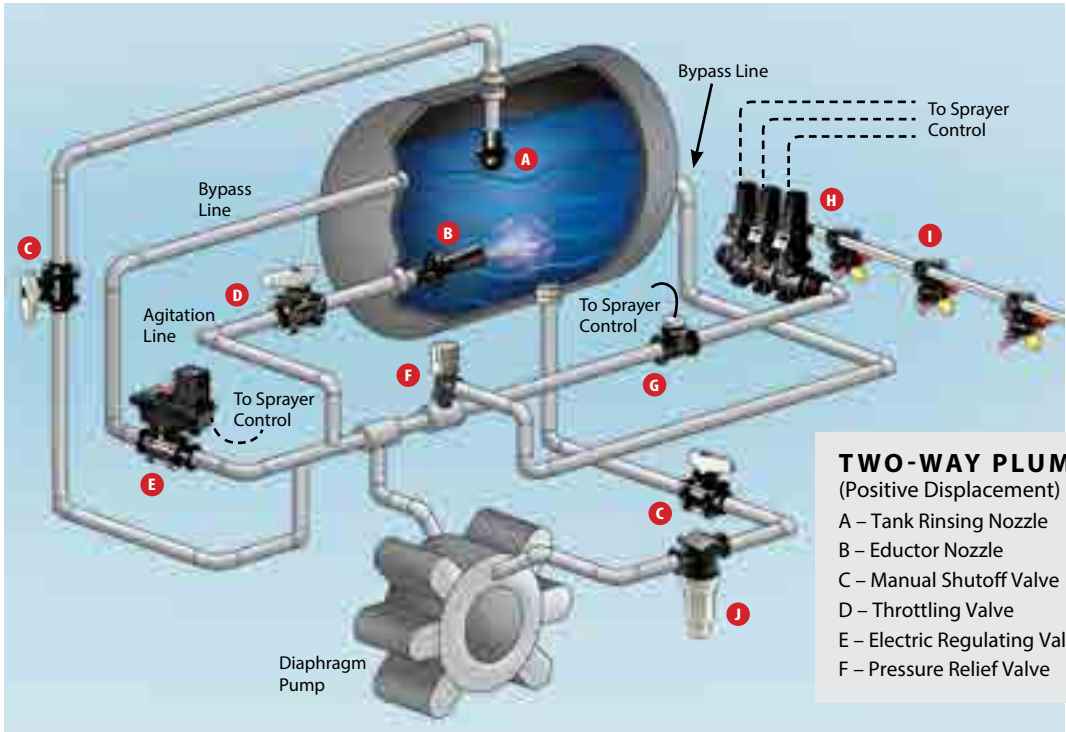

**TWO-WAY PLUMBING DIAGRAM**

(Positive Displacement)

- A – Tank Rinsing Nozzle
- B – Eductor Nozzle
- C – Manual Shutoff Valve
- D – Throttling Valve
- E – Electric Regulating Valve
- F – Pressure Relief Valve
- G – Flowmeter
- H – 2-Way Boom Control Manifold
- I – Nozzle Bodies & Spray Tips
- J – Line Strainer

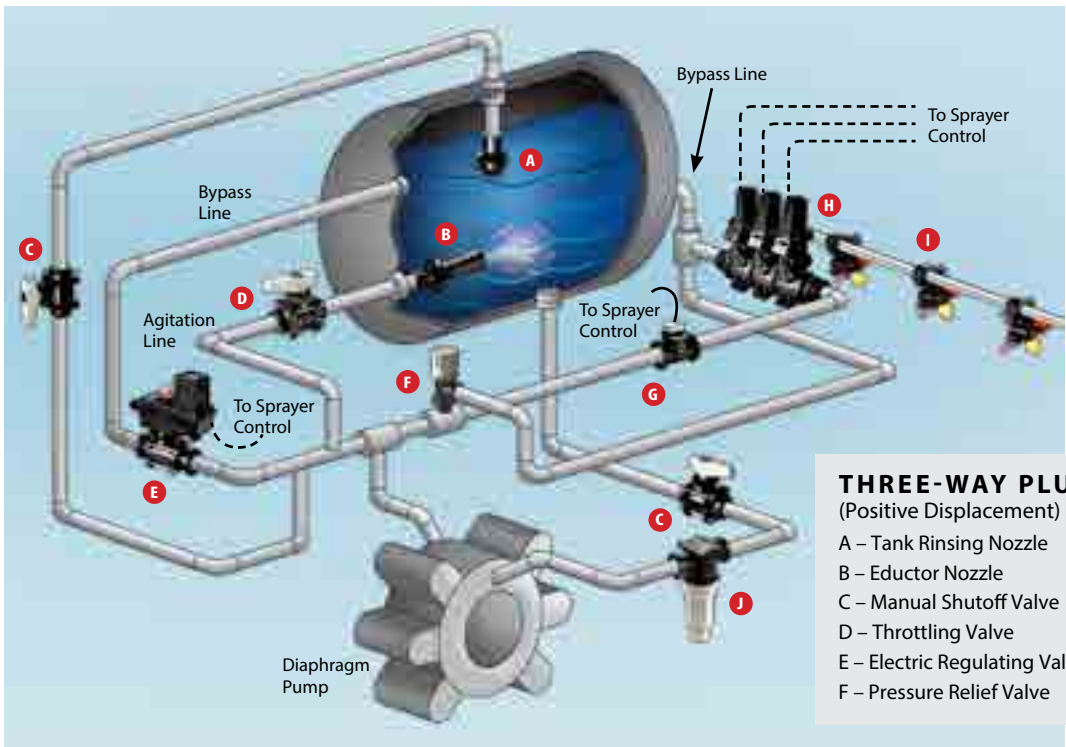

**THREE-WAY PLUMBING DIAGRAM**

(Positive Displacement)

- A – Tank Rinsing Nozzle
- B – Eductor Nozzle
- C – Manual Shutoff Valve
- D – Throttling Valve
- E – Electric Regulating Valve
- F – Pressure Relief Valve
- G – Flowmeter
- H – 3-Way Boom Control Manifold
- I – Nozzle Bodies & Spray Tips
- J – Line Strainer

**NON-POSITIVE DISPLACEMENT PUMP**

The centrifugal pump is the most common non-positive displacement pump. The output from this type of pump is influenced by pressure. This pump is ideal for delivering large volumes of liquid

at low pressures. A key component of the centrifugal pump is the throttling valve. A manual throttling valve on the main output line is essential for the accurate operation of the centrifugal pump.

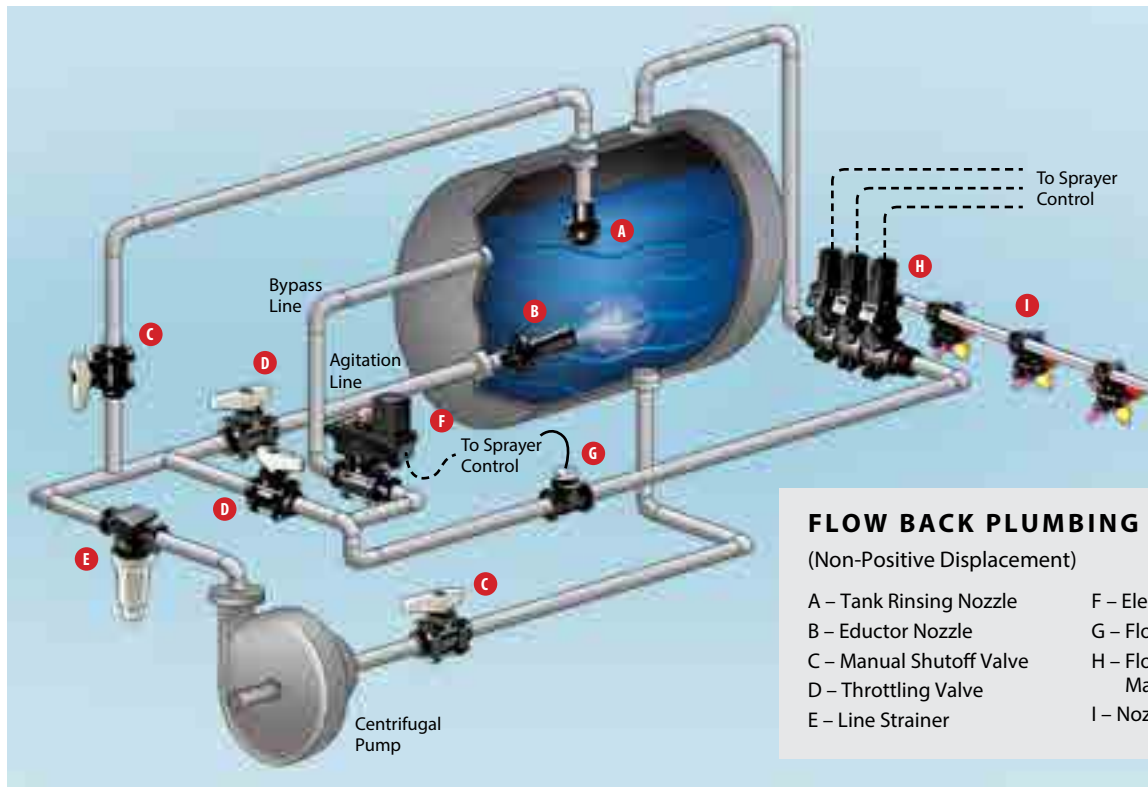
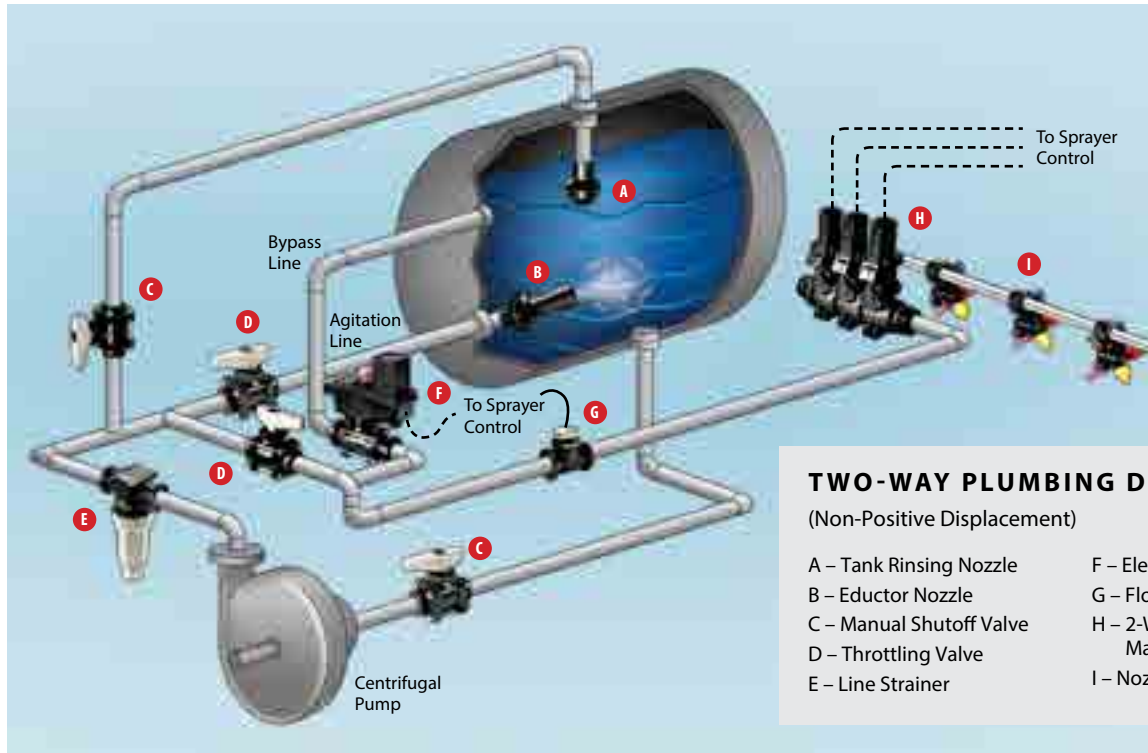

TECHNICAL INFORMATION



A small percentage of the items shown in this catalog may not be produced under an ISO registered system. For further information contact your sales representative.

## (1) MODIFICATION OF TERMS

Seller's acceptance of any order is expressly subject to Buyer's assent to each and all of the terms and conditions set forth below and Buyer's assent to these terms and conditions shall be conclusively presumed from Buyer's receipt of this document without prompt written objection thereto or from Buyer's acceptance of all or any part of goods ordered. No addition to or modification of said terms and conditions shall be binding upon Seller unless specifically agreed to by Seller in writing. If Buyer's purchase order or other correspondence contains terms or conditions contrary to or in addition to the terms and conditions set forth below, acceptance of any order by Seller shall not be construed as assent to such contrary or additional terms and conditions or constitute a waiver by Seller of any of the terms and conditions.

## (2) PRICE

Unless otherwise specified: (a) all prices, quotations, shipments and deliveries by Seller are (i) EXW (Incoterms® 2010) if shipped to the Buyer within the United States, and (2) in all other circumstances DAP Buyer's location (Incoterms® 2010); (b) all base prices together with related extras and deductions, are subject to Seller's price in effect at the time of shipment; and (c) notwithstanding the use of the shipping term DAP and without any effect on the point at which the risk of loss shifts from Seller to Buyer, all transportation, import costs and other related charges are for the account of Buyer, including all increases or decreases in such charges prior to shipment. Payment of said price shall be due at the remittance address shown on the Seller's invoice upon receipt of Seller's invoice unless otherwise specified. Interest will be charged at a rate of 1 to 11/2% per month on all balances outstanding more than 30 days after the date of the invoice. Price includes Seller's standard packaging. Special packaging requirements shall be quoted at an additional price.

## (3) UNIFORM COMMERCIAL CODE

THIS IS A CONTRACT FOR THE SALE OF GOODS. SELLER AND BUYER EXPRESSLY AGREE THAT ANY SERVICES PROVIDED PURSUANT TO THIS CONTRACT ARE MERELY INCIDENTAL TO THE SALE OF GOODS, AND AS SUCH, SHALL BE DEEMED GOODS UNDER ARTICLE 2 OF THE UNIFORM COMMERCIAL CODE. SELLER AND BUYER FURTHER AGREE THAT ANY DISPUTES ARISING FROM THIS CONTRACT SHALL BE GOVERNED BY ARTICLE 2 OF THE UNIFORM COMMERCIAL CODE.

## (4) MINIMUM BILLING

Contact your regional office representative for any minimum order requirements.

## (5) WARRANTIES

Seller warrants that its products will substantially conform to and perform in accordance with the products' specifications. Seller warrants that the products do not infringe upon any copyright, patent, or trademark. THE FOREGOING WARRANTIES ARE IN LIEU OF ALL OTHER WARRANTIES, EXPRESSED OR IMPLIED, INCLUDING, BUT NOT LIMITED TO, THOSE CONCERNING MERCHANTABILITY AND FITNESS FOR A PARTICULAR PURPOSE.

## (6) LIMITATION OF REMEDIES

Buyer's remedies under this warranty shall be limited to the replacement, repair, or refund of the purchase price for any defective product at the Seller's option. Products claimed to be defective and for which repair or replacement is desired shall be, if requested by the Seller, returned transportation prepaid to Seller's plant for inspection. Results of ordinary wear and tear, improper operation, or maintenance or use of

corrosive or abrasive materials shall not be considered a defect in material or workmanship. Any component part manufactured by another is not covered by Seller's warranty, but only by such warranty as its manufacturer gives. Because of the difficulty of asserting and measuring damages hereunder, it is agreed that, except for claims for bodily injury, Seller's liability to the Buyer or any third party, for any losses or damages, whether direct or otherwise, arising out of the purchase of product from Seller by Buyer shall not exceed the total amount billed and billable to the Buyer for the product hereunder. IN NO EVENT WILL SELLER BE LIABLE FOR ANY LOSS OF PROFITS OR OTHER SPECIAL OR CONSEQUENTIAL DAMAGES, EVEN IF SELLER HAS BEEN ADVISED OF THE POSSIBILITY OF SUCH DAMAGES.

## (7) QUALITY ASSURANCE

Seller shall have no obligation to ensure that any goods purchased from Seller meet any special Buyer quality assurance specifications and/or other special Buyer requirements unless such specifications and/or other requirements are specifically set forth in Buyer's purchase order and expressly accepted by Seller. In the event that any such goods supplied by Seller in connection therewith, are applied to an end use without the appropriate specification and/or other requirement therefore having been set forth in Buyer's purchase order and expressly accepted by Seller, Buyer shall indemnify and hold Seller harmless against any and all damages or claims for damages made by any person for any injury, fatal or nonfatal, to any person or for any damage to the property of any person incident to or arising out of such application.

## (8) CLAIMS

Claims respecting the condition of goods, compliance with specifications or any other matter affecting goods shipped to Buyer must be made promptly and, unless otherwise agreed to in writing by Seller, in no event later than one (1) year after receipt of the goods by Buyer. In no event shall any goods be returned, reworked or scrapped by Buyer without the express written authorization of Seller.

## (9) DEFAULT IN PAYMENT

If Buyer fails to make payments on any contract between Buyer and Seller in accordance with Seller's terms, Seller, in addition to any other remedies available to it, may at its option, (i) defer further shipments until such payments are made and satisfactory credit arrangements are reestablished or (ii) cancel the unshipped balance of any order.

## (10) TECHNICAL ASSISTANCE

Unless otherwise expressly stated by Seller, (a) any technical advice provided by Seller with respect to the use of goods furnished to Buyer shall be without charge; (b) Buyer shall have sole responsibility for selection and specification of the goods appropriate for the end use of such goods.

## (11) SAFETY PRECAUTIONS

Buyer shall require its employees to use all safety devices, and proper safe operation procedures as set forth in manuals and instruction sheets furnished by Seller. Buyer shall not remove or modify any such device or warning sign. It is the Buyer's responsibility to provide all means that may be necessary to effectively protect all employees from serious bodily injury which otherwise may result from the method of particular use, operation, set up or service of the goods. The operator's or machine manual, ANSI safety standards, OSHA regulations and other sources should be consulted. If Buyer fails to comply with provisions of this paragraph or the applicable standards and regulations aforementioned, and a person is injured as a result thereof, Buyer agrees to indemnify and save Seller harmless from any liability or obligation incurred by Seller.

## (12) CANCELLATION

Orders for goods specifically manufactured for Buyer cannot be canceled or modified by Buyer, and releases cannot be held up by Buyer, after such goods are in process except with the express written consent of Seller and subject to conditions then to be agreed upon which shall include, without limitation, protection of Seller against all loss.

## (13) PATENTS

The Seller shall not be liable for any costs or damages incurred by the Buyer as a result of any suit or proceeding brought against Buyer so far as based on claims (a) that use of any product, or any part thereof furnished hereunder, in combination with products not supplied by the Seller or (b) that a manufacturing or other process utilizing any product, or any part thereof furnished hereunder, constitute knowing and willful infringement of patents or trademarks arising from compliance with Buyer's designs or specifications or instructions.

## (14) COMPLETE AGREEMENT

THIS CONTRACT SETS FORTH THE ENTIRE AGREEMENT AND UNDERSTANDING OF THE PARTIES RELATING TO THE SUBJECT MATTER HEREOF, AND SUPERSEDES ALL PRIOR AGREEMENTS, DISCUSSIONS AND UNDERSTANDINGS BETWEEN THEM WHETHER ORAL OR WRITTEN, RELATING TO THE SUBJECT MATTER HEREOF.

## (15) GOVERNING LAW

All orders are accepted by Seller at its mailing address in Wheaton, Illinois, and shall be governed by and interpreted in accordance with the laws of the State of Illinois. The United Nations Convention on Contracts for the International Sale of Goods of April 11, 1980 shall be excluded.

## (16) FORCE MAJEURE

Neither party shall be in default of its obligations to the other party for any period of Force Majeure. "Force Majeure" shall mean any delay or failure of a party to perform its obligations to the other party due to causes beyond its control and without its fault or negligence. This shall include, without limitation, Acts of God, strike, civil commotion, acts of government, and any other comparable, non-foreseeable, and a serious event.

## (17) CONFIDENTIAL INFORMATION

Buyer shall maintain Confidential Information in confidence using the same care as used for its own Confidential Information. Buyer shall not disclose or divulge any Confidential Information received by it from Seller in connection with any products or services supplied by Seller to Buyer or to a third party without prior written consent of Seller, and Buyer may not use any Confidential Information for any purpose other than for the manufacture, sale and maintenance of Buyer's products. For the purposes hereof, "Confidential Information" includes any and all information and data, including, but not limited to, any business, commercial, intellectual property, technical information and data disclosed by Seller to Buyer in connection with the sale of Seller's products to Buyer, or relating to Seller's business relationship or the definition, development, marketing, selling, manufacture or distribution of Seller's products, whether disclosed orally, in writing or electronically, and irrespective of the medium in which such information or data is embedded, whether in tangible form or contained in an intangible storage medium. Confidential Information shall include any copies or abstracts made thereof, as well as any product, apparatus, modules, samples, prototypes or parts thereof.





**WHEATON FACILITY**

P.O. BOX 7900  
WHEATON, ILLINOIS  
60187-7901 USA

**SPRINGFIELD FACILITY**

1801 BUSINESS PARK DRIVE  
SPRINGFIELD, ILLINOIS  
62703 USA

**AABYBRO FACILITY**

MØLHAVEVEJ 2  
DK 9440 AABYBRO  
DENMARK



**TEEJET.COM**



All rights reserved. Full Protection of law claimed under Universal Copyright and Berne Conventions and other applicable national and international laws.

Printed in U.S.A. © Copyright 2023 TeeJet Technologies

LI52-R1