



U S E R G U I D E

TeeJet[®]

RX410p

Copyrights

© 2007 TeeJet Technologies Inc. All rights reserved. No part of this document or the computer programs described in it may be reproduced, copied, photocopied, translated, or reduced in any form or by any means, electronic or machine readable, recording or otherwise, without prior written consent from TeeJet Technologies, Inc.

Trademarks

Unless otherwise noted, all other brand or product names are trademarks or registered trademarks of their respective companies or organizations.

Limitation of Liability

TEEJET TECHNOLOGIES, INC. PROVIDES THIS MATERIAL "AS IS" WITHOUT WARRANTY OF ANY KIND, EITHER EXPRESSED OR IMPLIED. NO COPYRIGHT LIABILITY OR PATENT IS ASSUMED. IN NO EVENT SHALL TEEJET TECHNOLOGIES, INC. BE LIABLE FOR ANY LOSS OF BUSINESS, LOSS OF PROFIT, LOSS OF USE OR DATA, INTERRUPTION OF BUSINESS, OR FOR INDIRECT, SPECIAL, INCIDENTAL, OR CONSEQUENTIAL DAMAGES OF ANY KIND, EVEN IF TEEJET TECHNOLOGIES HAS BEEN ADVISED OF SUCH DAMAGES ARISING FROM TEEJET SOFTWARE.

CHAPTER 1 - INTRODUCTION	1
FEATURES	1
Receiver	1
Antenna	1
INSTALLATION	2
Receiver	3
Antenna	4
CABLE INTERFACE	5
EXTERNAL DEVICE CONNECTIONS	5
Serial Ports	8
CHAPTER 2 - OPERATION	9
LEDS	9
MAIN MENU	10
DIFFERENTIAL MENUS	15
CHAPTER 3 - GPS OVERVIEW	19
AUTOMATIC TRACKING	19
RECEIVER PERFORMANCE	19
DIFFERENTIAL OPERATION	19
AUTOMATIC SBAS (WAAS, EGNOS, MSAS, ETC.) TRACKING	19
E-DIF	20
L-DIF	20
OMNISTAR VBS	20
APPENDIX A - TROUBLESHOOTING	21
APPENDIX B - RX410P SPECIFICATIONS	23

CHAPTER 1 - INTRODUCTION

The RX410p is a GPS receiver and antenna system that tracks GPS and SBAS. The high accuracy, multipurpose receiver is capable of receiving GPS and SBAS signals as well as optional radio beacon. This system is upgradeable to output messages up to 20Hz. The menu system provides easy system configuration and the status LEDs provide quick updates on the receiver condition. The Smart Antenna offers an affordable, portable solution with professional level accuracy for agricultural, marine, GIS mapping, and other applications. It provides fast start-up and reacquisition times, 23.6 inch / 60 cm accuracy, and an easy-to-see status indicator for power, GPS, and DGPS. The durable enclosure houses both antenna and receiver. It can be powered through various sources, making the Smart Antenna ideal for a variety of applications. Dual-serial, CAN, and pulse output options make this DGPS receiver compatible with almost any interface.

FEATURES

Receiver

- Feature-packed sub-23.6 inch / 60cm DGPS positioning
- Differential options including SBAS (WAAS, EGNOS, etc.), Radio Beacon, OmniSTAR
- Exclusive e-Dif[®] option where other differential correction signals are not practical
- COAST[™] technology maintains accurate solutions for 40 minutes or more after loss of differential signal
- Fast output rates of up to 20 times per second provide the best guidance and machine control
- Compatible with L-Dif[™] technology for applications requiring accuracy under 7.9 inches / 20cm
- The status lights and menu system make the receiver easy to monitor and configure

Antenna

- Affordable solution for unparalleled sub-meter performance - 23.6 in / 60cm accuracy, 95% of the time
- COAST[™] stability during temporary differential signal outage
- Exclusive e-Dif[®] option where other differential signals are not practical
- Compatible with L-Dif[™] technology for applications requiring accuracy under 7.9 in / 20cm
- Fast output rates of up to 20 times per second provide the best visual guidance and automated steering signals for all types of applications
- Compact, low-profile design with fixed or magnetic mounting options - ideal for portable and dynamic applications
- Radar-simulated pulse output provides accurate ground speed

Figure 1-1: Receiver and Antenna



INSTALLATION

Open the shipping box and examine the contents for signs of damage. Please notify the shipper and TeeJet Customer Support of any damage to the shipping box or its contents immediately. Make sure all items have been received. Contents may vary depending upon the system ordered. The following table lists standard components that should arrive with an RX410p system. Please retain the original invoice and shipping box. These are required if the system needs to be shipped or returned.

Table 1-1: RX410p Components

RX410p System Components	Part Number	Quantity
RX410p Receiver Kit	78-50159	1
Base, Antenna, Magnetic Mount	78-50070	1
Receiver, RX410p	78-50161	1
Antenna, RX410p	78-50162	1
Bracket, RX410p	65-05174	1
Cable, Power, 10ft/3m	45-05132	1
Cable, Antenna, 16.4 ft/5m TNC-TNC	45-05134	1
Cable, Computer Interface	117-0500	1
Manual	98-05099	1

Receiver

It is not necessary to mount the RX410p receiver. However, if mounting is desired, several thumb screws, nuts, and brackets are provided in the kit. When choosing a mounting location, please ensure the menu screen, LEDs, and buttons are visible and accessible. Access to the back panel must be available for switching out cables and accessing the POWER button. There is an option within the menu system to switch the direction of the display, so if it is easier to mount the unit upside down, it may be mounted in that position and can still be easily operated.

NOTE: When mounting the receiver, mount the unit inside and away from the elements and in a location that minimizes vibration, shock, extreme temperatures, and moisture.

Figure 1-2: RX410p Illustration

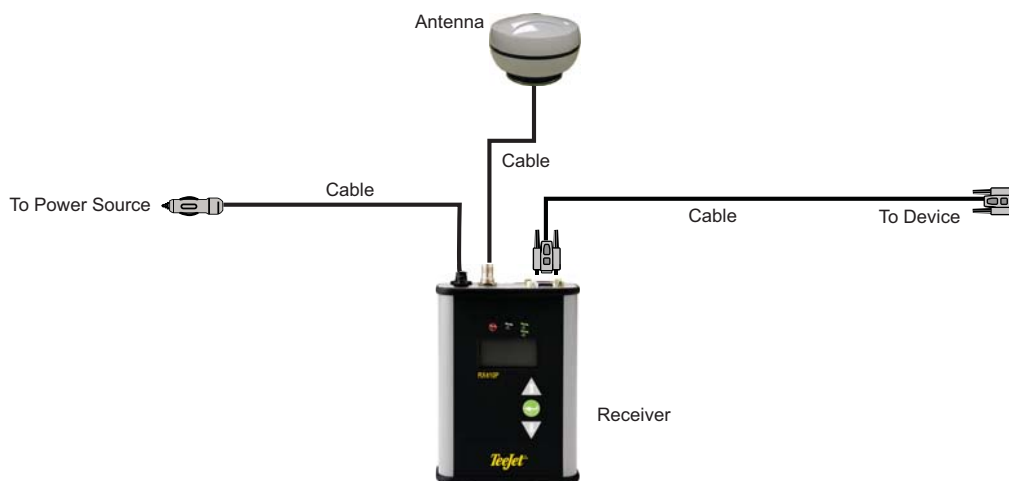

To install the brackets for mounting:

1. Slide the nuts through the openings along the sides of the receiver.
2. Place the bracket along the receiver and insert the thumbscrews so they screw into the nuts.
3. Secure the brackets in the location of choice.

Antenna

Placement of the antenna is crucial to the system's operation. The GPS engine inside the antenna computes a position based upon measurements from each satellite to the phase center of the antenna. Mount the antenna at the desired location of reference. When choosing a mounting location, make certain that there is a clear view of the sky. This will ensure that GPS satellites are not masked by obstructions, potentially reducing system performance.

Mount the antenna on, or as close to, the center point of measurement of the vehicle. The antenna can be mounted magnetically, on the vehicle's surface, or on a pole.

Magnetic Mount

The magnetic mount can be secured by screwing it into the bottom of the antenna and mounting it to any metal surface. A metal disc and foam adhesive is included with each magnetic mount. Use the foam adhesive to bond the metal disc to the desired mounting location if there is no metal surface available. To use the metal disc and foam adhesive:

1. Clean and dry the mounting surface on the vehicle.
2. Remove the backing from one side of the foam adhesive and press the metal plate onto the mounting surface on the vehicle.
3. Remove the backing from the other side of the foam adhesive.
4. Press the metal plate onto the mounting surface of the vehicle.
5. Apply firm pressure to ensure good adhesion.
6. Place the antenna on top of the metal disc.

Surface Mount

As an alternative to the magnetic mount, the antenna is easily attached to the surface with four machine screws (not included). To surface mount the antenna:

1. Photocopy the bottom of the antenna and use it as a template to plan the mounting hole locations.

WARNING! *Make sure the photocopy is scaled ONE TO ONE with the mounting holes on the bottom of the antenna!*

2. Mark the mounting hole centers as necessary on the mounting surface.
3. Place the antenna over the marks to ensure that the planned hole centers agree with the true hole centers. Adjust as necessary.
4. Use a center punch on the hole centers in order to guide the drill bit.
5. Drill the mounting holes with a 3/16-inch /4.7625 mm bit appropriate for the surface mount.

6. Place the antenna over the mounting holes and insert the mounting screws through the bottom of the mounting surface and into the antenna.

WARNING! *Install the antenna only hand-tight. Damage resulting from overtightening the antenna is not covered by warranty.*

Pole Mount

The center thread of the antenna is 5/8 inches / 15.875 mm for compatibility with a survey pole (not included).

CABLE INTERFACE

The power cable must reach an appropriate power source. The data cable may connect to a data storage device, computer, or other device that accepts GPS data.

When choosing a route for all of the cables:

- Avoid running cables in areas of excessive heat
- Keep cables away from corrosive chemicals
- Do not run the extension cable through door or window jams
- Keep the cable away from rotating machinery
- Do not bend excessively or crimp the cables
- Avoid placing tension on the cables
- Remove unwanted slack from the extension cable at the receiver end
- Secure along the cable route using plastic wrap

WARNING! *Cables improperly installed near machinery can be dangerous.*

When connecting the various cables to different devices:

1. Connect the power cable to the appropriate power source.
2. Connect the antenna cable from the receiver to the antenna.
3. Connect the data port(s) to any required device.

EXTERNAL DEVICE CONNECTIONS

The serial ports of the RX410p operate at the RS-232C interface level to communicate with external data loggers, navigation systems, and other devices. The two serial ports are accessible via the back panel. The serial ports are accessible by two DB9 female connectors. Either serial port can be used for firmware updates. Figure 1-3 illustrates the numbering for the DB9 connectors (female).

Figure 1-3: DB9 Socket Numbering

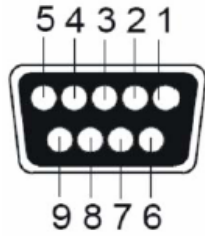

Note: For successful communication, the baud rate of the RX410p serial ports must be set to match that of the devices to which they are connected. Tables 1-2 and 1-3 provide the pin configuration for the serial ports.

Table 1-2: Port A Pin-Out

Pin Number	Function
1	Not connected
2	Transmit data Port A
3	Receive data Port A
4	Not connected
5	Signal ground
6	Event marker
7	Not connected
8	Not connected
9	1 PPS

Table 1-3: Port B Pin-Out

Pin Number	Function
1	Not connected
2	Transmit data Port B
3	Receive data Port B
4	Not connected
5	Signal ground
6	Not connected
7	Not connected
8	Not connected
9	Not connected

Table 1-4: DGPS Options

DGPS Options
SBAS (WAAS, EGNOS, MSAS, etc.)
e-Dif [®]
External RTCM
L-Dif [®]

Table 1-5: Serial Port Settings

Serial Port	Baud Rate	Data Bits	Parity	Stop Bits	Interface Level
Serial Port A and B	4800	8	None	1	R2-232C
	9600				
	19200				
	38400				
	57600				

Table 1-6: GPS Message Output Options

GPS Message	Update Rate	Max DGPS Age	Elevation Mask
GPS Binary	From 1 Hz to 20 Hz	259,200 seconds	5°
NMEA 0183 GGA	From 1 Hz to 20 Hz	259,200 seconds	5°
NMEA 0183 GLL	From 1 Hz to 20 Hz	259,200 seconds	5°
NMEA 0183 GSA	1 Hz	259,200 seconds	5°
NMEA 0183 GST	1 Hz	259,200 seconds	5°
NMEA 0183 GSV	1 Hz	259,200 seconds	5°
NMEA 0183 RMC	1 Hz	259,200 seconds	5°
NMEA 0183 RRE	1 Hz	259,200 seconds	5°
NMEA 0183 VTG	From 1 Hz to 20 Hz	259,200 seconds	5°
NMEA 0183 ZDA	1 Hz	259,200 seconds	5°

Serial Ports

The RX410p features two serial ports. The ports handle communications to and from the receiver and antenna. The ports may be configured for a mixture of NMEA 0183, binary data, and RTCM SC-104 data.

Custom Configuration of the RX410p

All aspects of the RX410p may be configured through the serial port with the use of GPS commands. Many aspects of the receiver may also be configured.

Environmental Considerations

The RX410p receiver is designed to be placed indoors. It is, however, splash proof in case of accidental exposure. The antenna is designed to be used outdoors.

NOTE: The changes made to the RX410p via the serial port will not be saved to memory for subsequent power-up unless a save command is issued (\$JSAVE). If changes are made via the menu system, they are saved automatically.

NOTE: Contact your local TeeJet Technologies dealer for additional information regarding the use of GPS commands and customized configuration.

CHAPTER 2 - OPERATION

To power up the RX410p:

1. Connect the ends of the RX410p power cable to a clean power source providing between 8 and 36 VDC. The supplied power should be continuous and clean for best performance.
2. Turn on the system by pressing the ON/OFF switch on the back panel.

NOTE: *A weather-tight connection and connector is suggested for use if the cable will be located outside.*

WARNING! *Be careful not to provide a voltage higher than the input range (36 VDC). This will damage the receiver and will void the warranty.*

WARNING! *Do not attempt to operate the RX410p with the fuse bypassed. Such a modification will void the product warranty.*

The RX410p features reverse polarity protection to prevent damage if the power leads are accidentally reversed. With the application of power, the RX410p will proceed through an internal start-up sequence. However, it will immediately be ready for communication.

NOTE: *The initial start-up can take from 5 to 15 minutes depending upon location. Subsequent start-ups will output a valid position within 1 to 5 minutes depending on location and the amount of time since the last start-up.*

NOTE: *The RX410p can take up to 5 minutes for a full ionospheric map to be received from SBAS. Optimum accuracy will be obtained once the RX410p is processing corrected positions using complete ionospheric information.*

LEDS

The RX410p uses three LEDs. The LED functions are defined as:

- Power Indicator LED (red). This LED illuminates when the RX410p is powered.
- GPS Lock Indicator LED (yellow). This LED remains illuminated with the RX410p achieves a solid GPS lock.
- DGPS Position Indicator LED (solid green). This LED remains illuminated in solid green when the receiver has achieved a differential position and a pseudo range residual of better than 32.8 feet / 10.0 meters. If the residual value is worse than the current threshold, the green LED will blink, indicating that differential mode has been attained but that the residual has not met the threshold.

MAIN MENU

The menu system of the RX410p is designed for easy setup and configuration in the field or in the office. Most configuration can be completed entirely through the menu system without having to connect to a computer or PDA. The menu software supports many different languages so individuals with varied backgrounds can easily understand the configuration of the receiver. If at any time the menu system needs to be reverted to system default, simply hold down the *Enter* button and power on until the splash screen disappears.

The *Up* and *Down Arrow* buttons are used to navigate through the menu items. The *Enter* button is used to enter into a sub-menu item or select the desired menu option.

Figure 2-1: Main Menu A

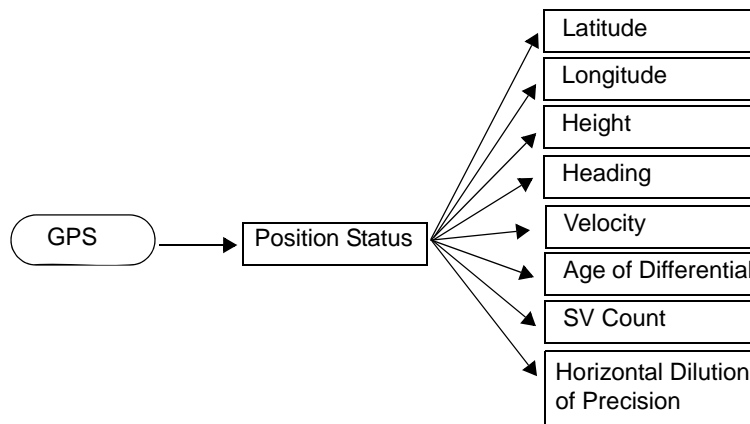

Figure 2-2: Main Menu B

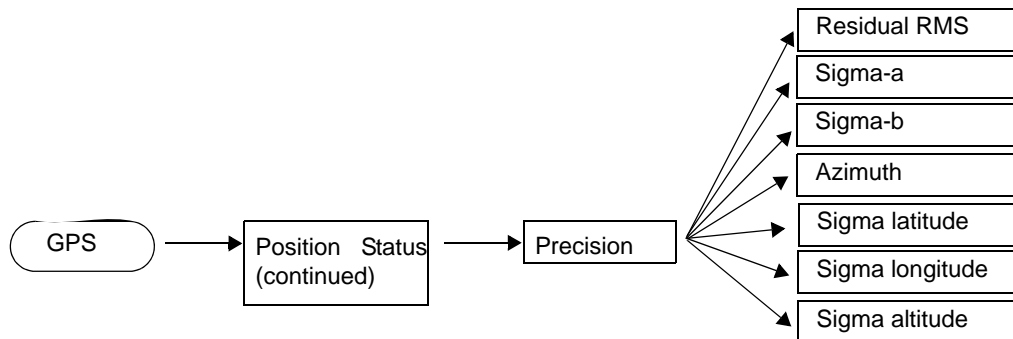

Figure 2-3: Main Menu C

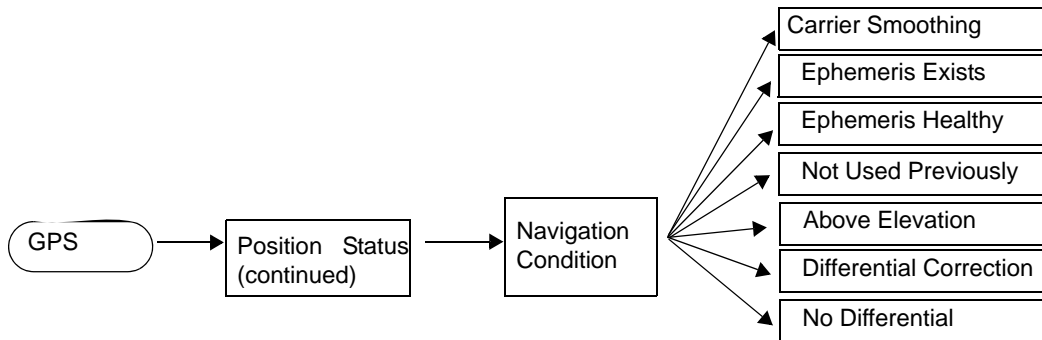

Figure 2-4: Main Menu D

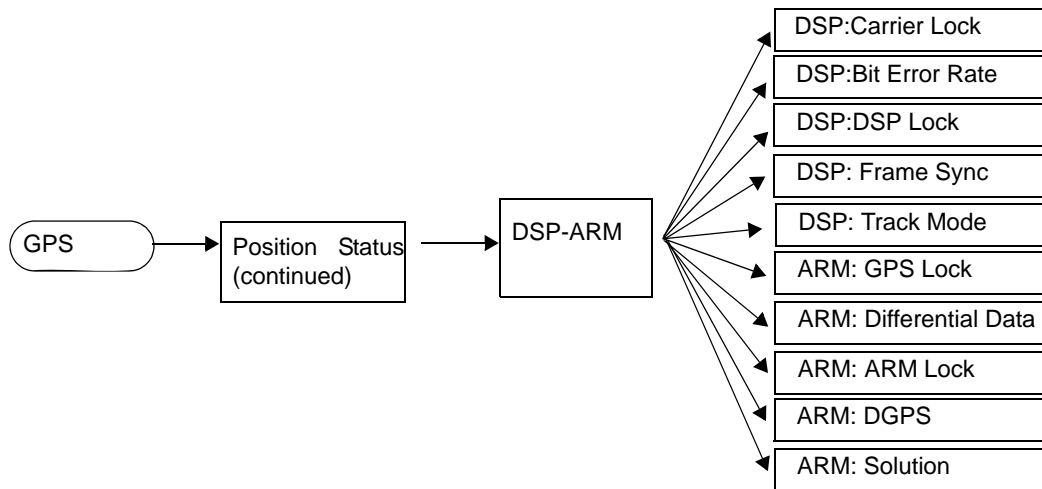

Figure 2-5: Main Menu E

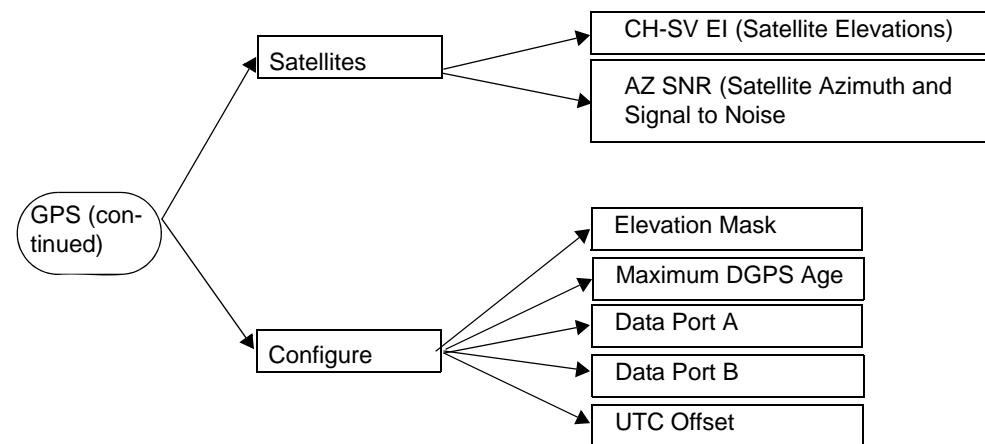

Figure 2-6: Main Menu F

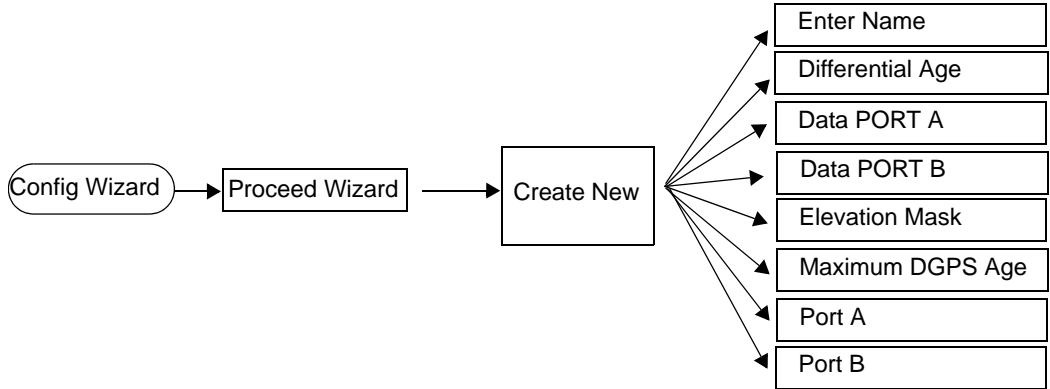

Figure 2-7: Main Menu G

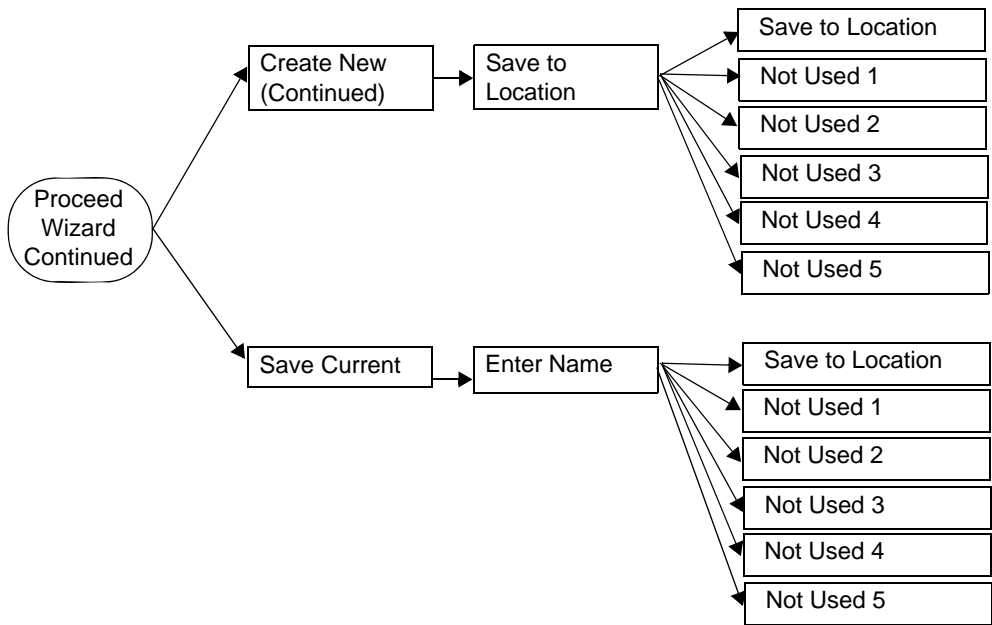

Figure 2-8: Main Menu H

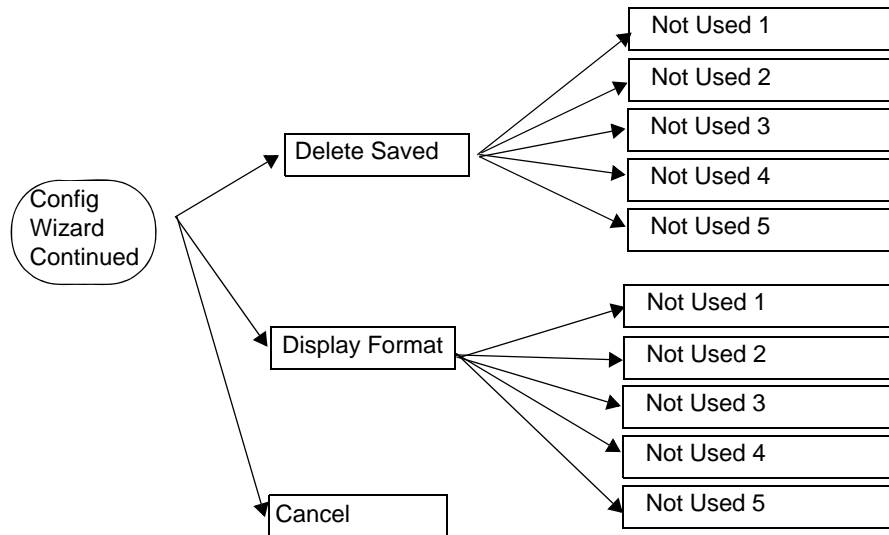

Figure 2-9: Main Menu I

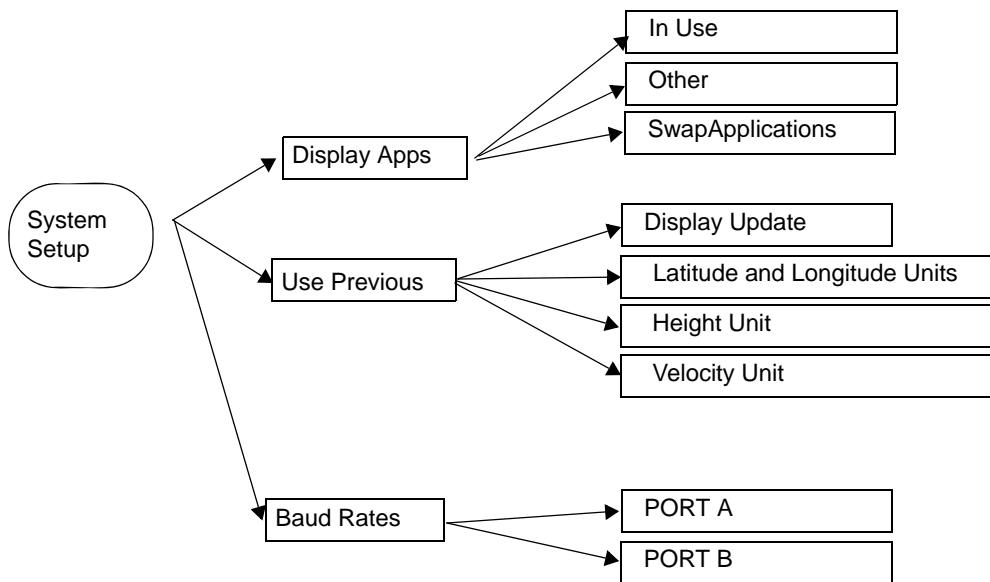

Figure 2-10: Main Menu J

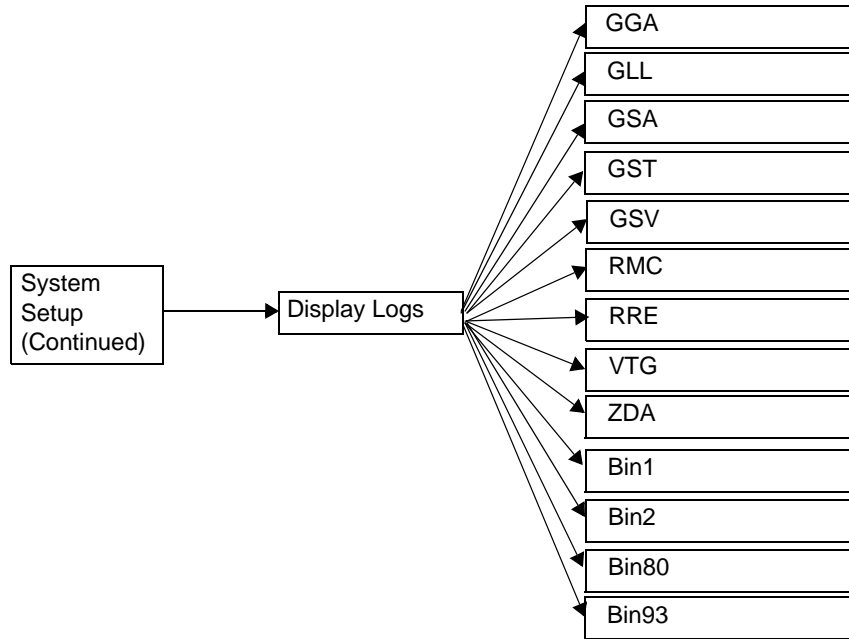
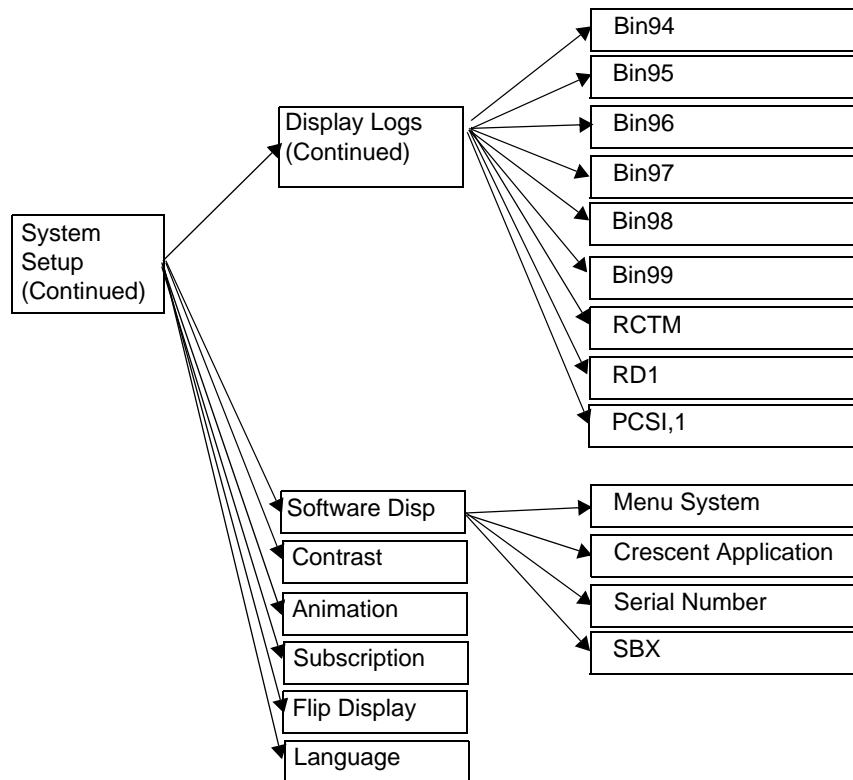

Figure 2-11: Main Menu K



DIFFERENTIAL MENUS

The following figures provide the flowcharts for the differential menus.

Figure 2-12: Differential Menu A

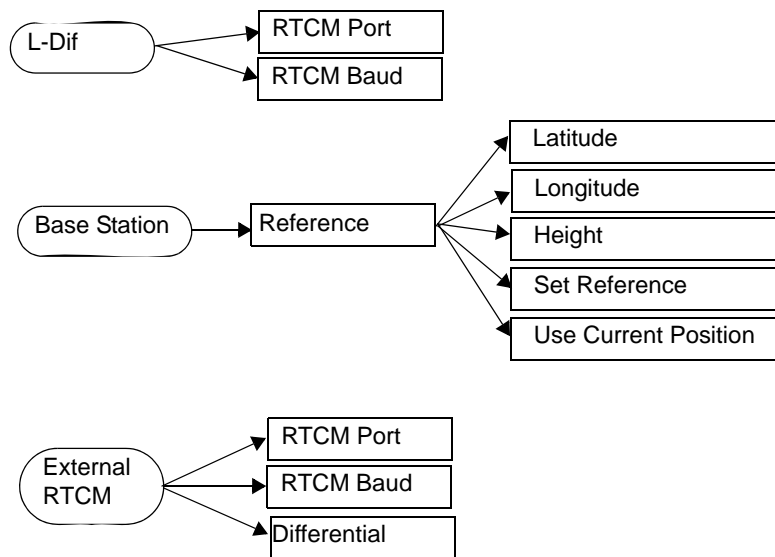

Figure 2-13: Differential Menu B

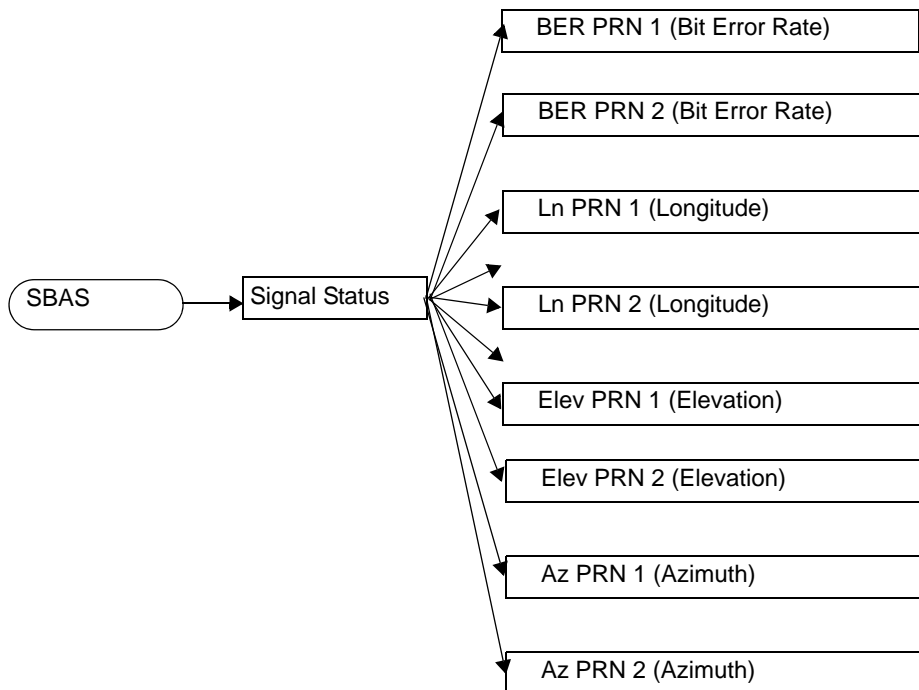

Figure 2-14: Differential Menu C -1

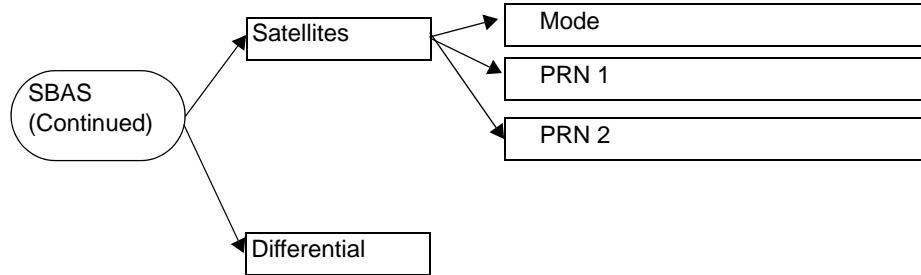

Figure 2-15: Differential Menu C-2

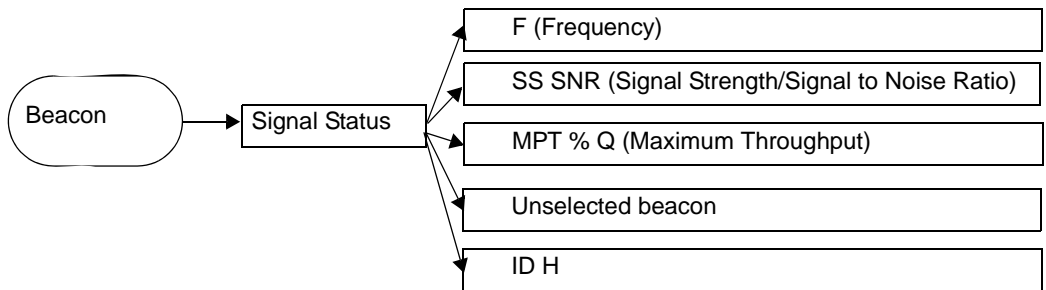

Figure 2-16: Differential Menu D

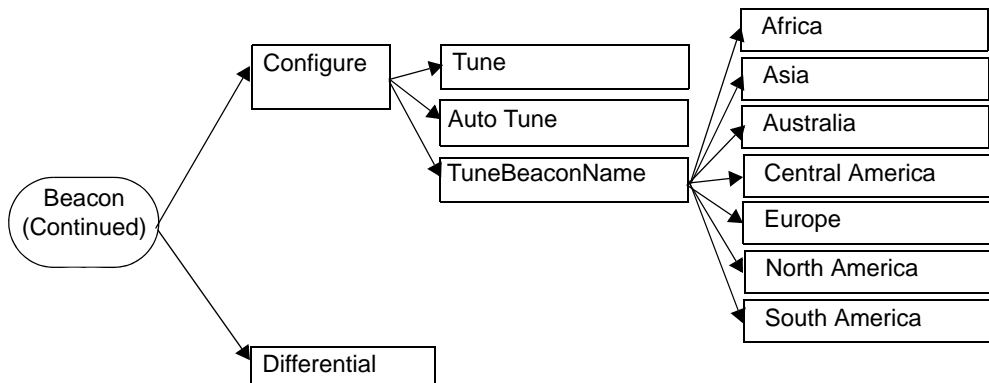

Figure 2-17: Differential Menu E

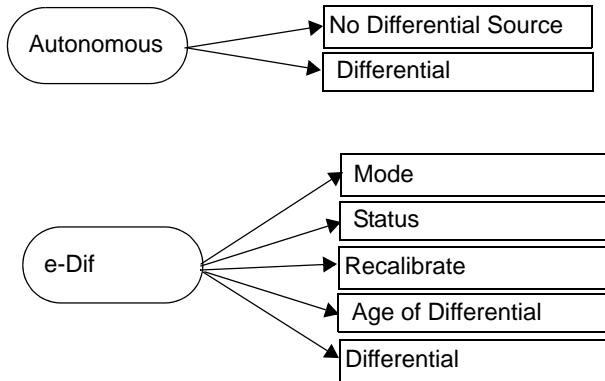

Figure 2-18: Differential Menu F

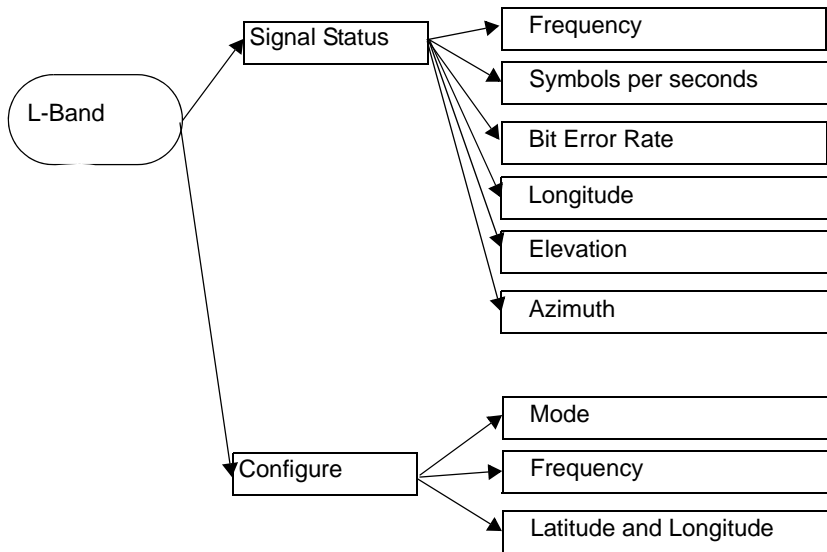
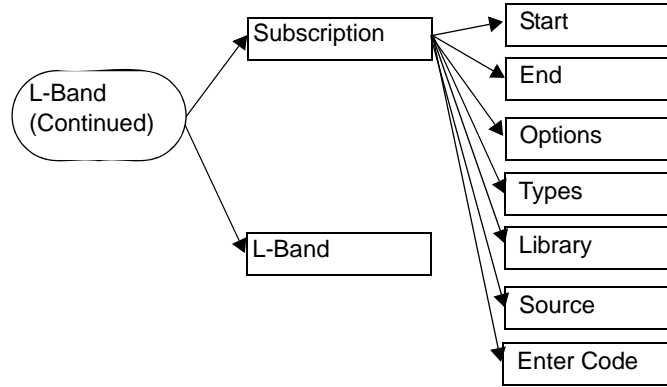

Figure 2-19: Differential Menu G



CHAPTER 3 - GPS OVERVIEW

When powered, the GPS engine is always operating, regardless of the DGPS mode of operation. The following sections describe the general operation of the RX410p's internal GPS engine.

AUTOMATIC TRACKING

The GPS engine within the RX410p automatically searches for GPS satellites, acquires the signals, and manages the navigation information required for positioning and tracking. This is a hands-free mode of operation.

RECEIVER PERFORMANCE

The RX410p works by locating four or more GPS satellites in the visible sky and uses the information those satellites provide to compute an appropriate position (within 16.4 feet / 5 meters). Since some error is possible in GPS data calculation, the RX410p also tracks a differential source. The RX410p uses these corrections to improve its position to less than 3.3 feet / 1 meter.

There are two main aspects of GPS receiver performance:

- Positioning
- Satellite acquisition quality

The satellites transmit coded information to the antenna on a specific frequency that allows the receiver to calculate a range to each satellite. GPS is essentially a timing system. The ranges are calculated by timing how long it takes for the GPS signal to reach the GPS antenna. To calculate the geographic location, the GPS receiver uses a complex algorithm incorporating satellite locations and ranges to each satellite. Reception of any four or more of these signals allows a GPS receiver to compute 3-dimensional coordinates.

DIFFERENTIAL OPERATION

The purpose of differential GPS (DGPS) is to remove the effects of atmospheric errors, timing errors, and satellite orbit errors while enhancing system integrity. Autonomous positioning capabilities of the RX410p will result in positioning accuracies of 8.2 feet / 2.5 meters (95%). In order to improve positioning quality to sub-meter levels, the RX410p is able to use differential corrections received through the internal SBAS demodulator or through software upgrades and subscription code may also use e-Dif and L-Dif applications.

AUTOMATIC SBAS (WAAS, EGNOS, MSAS, ETC.) TRACKING

The RX410p will automatically scan and track SBAS signals without the need to tune the receiver. The RX410p features two-channel SBAS tracking that provides an enhanced ability to maintain a lock on an SBAS satellite when more than one satellite is in view. This redundant tracking approach results in more consistent tracking of an SBAS signal when in an area where signal blockage of a satellite is possible.

E-DIF

Extended differential (e-Dif) is an optional mode in which the receiver can perform with differential-like accuracy for extended periods of time without the expense or uncertainty of an external differential service. It models the effects of ionosphere, troposphere, and timing errors for extended periods by computing its own set of pseudo-corrections. e-Dif may be used anywhere geographically and is especially useful where SBAS networks have not yet been installed, such as South America, Africa, Australia, and Asia.

The positioning performance of the receiver unit is dependent upon the rate at which the environmental modeling of e-Dif and the environmental errors diverge. The more that e-Dif is able to model the errors correctly, the longer that e-Dif will provide reliable, accurate positioning. The accuracy of positioning will have a very slow rate of drift. It depends on how tolerable the application is to drift and absolute positioning as e-Dif can be recalibrated regularly or just once at the beginning of its use. Testing has shown that accuracy will often be better than 3.28 feet / 1.0 meter virtually 95% of the time for up to 30 minutes of e-Dif operation.

L-DIF

Local differential (L-Dif) is a proprietary GPS method where a specialized set of messages are relayed between two receivers. Because the messages transmitted are in proprietary format, two receivers are necessary for local differential operation. A base receiver is established on a site of known or unknown coordinates, which then broadcasts corrections to a rover unit. Performance testing has resulted in positioning accuracy of less than 7.87 inches / 20 cm.

OMNISTAR VBS

OmniSTAR VBS is a satellite based differential signal. The end user must pay a subscription fee for access to this signal. The receiver features an automatic mode that allows the receiver to locate the best spot beam if more than one is available in a particular region. This function frees the user from having to adjust the frequency of the OmniSTAR DGPS receiver. The OmniSTAR VBS receiver also features a manual tune mode for flexibility.

APPENDIX A - TROUBLESHOOTING

Table A provides a checklist to troubleshoot common problems and their solutions for the RX410p.

Problem	Possible Solution
Receiver fails to power	<ul style="list-style-type: none"> • Verify polarity of power leads • Check integrity of power cable connections • Check power input voltage (8-36 VDC) • Check current restrictions imposed by power source (maximum is 250 mA @ 12VDC) • Press the POWER button
No data from RX410p	<ul style="list-style-type: none"> • Check receiver power status (red LED) • Check integrity and connectivity of power and data cable connections • The volume of data requested to be output by the RX410p could be higher than what the current baud rate supports. Try using 19,200 or higher as the baud rate for all devices.
No GPS lock	<ul style="list-style-type: none"> • Check integrity of cable connections • Verify antenna's clear view of the sky
No SBAS lock	<ul style="list-style-type: none"> • Check integrity of cable connections • Verify antenna's clear view of the sky • Check SBAS visibility map
No beacon lock	<ul style="list-style-type: none"> • Check beacon listings to ensure proximity to a beacon station • Ensure there are no sources of interference nearby • Check antenna connections • Verify MSK rate is set correctly • Verify frequency of transmitting beacon • Select alternate antenna position
No OmniSTAR VBS lock	<ul style="list-style-type: none"> • Subscription activated and not expired? • Check antenna connections • Verify antenna's clear view of the sky

APPENDIX B - RX410P SPECIFICATIONS

Tables B-1 to B-5 provide the power, mechanical, communications, environmental, and DGPS specifications for the RX410p.

Table B-1: Power Specifications

Item	Power Specifications
Input Voltage	8-36 VDC
Power Consumption	< 3 W @ 12 VDC (typical)
Current Consumption	250 mA @ 12 VDC (typical)

Table B-2: Receiver Mechanical Specifications

Item	Power Specifications
Height	1.77 inch / 45 mm
Width	4.49 inch / 114 mm
Length	6.30 inch / 160 mm
Weight	1.19 pound / 0.54 kg

Table B-3: Communication Specifications

Item	Description
Serial Port	2 full duplex RS232
Pulse output	1 PPS (HCMOS, active high, rising edge sync)
Baud rates	4800 - 57600
Differential Correction I/O protocol	RTCM SC-104
Data I/O protocol	NMEA 0183 and Hemisphere GPS binary and RTCM
Event mark output	HCMOS, active low, falling edge sync, 10 k-ohm, 10pF load

Table B-4: Environmental Specifications

Item	Specifications
Operating temperature	-25.6° F to + 165.2° F / -32° C to + 74° C
Storage temperature	-40° F to + 185° F / - 40° C to + 85° C
Humidity	95%, non condensing

Table B-5: GPS Sensor Specifications

Item	Specifications
Receiver type	L1, C/A code with carrier phase smoothing (Patented COAST technology during differential signal outage)
Channels	12-channel, parallel tracking or 10-channel, GPS, 2-channel, SBAS
Update rate	1-20 Hz
Horizontal accuracy	< 2 feet / 0.6 m 95% confidence (DGPS)* <8.2 feet / 2.5 m 95% confidence (autonomous) **
Differential Options	SBAS, e-Dif, L-Dif, Radio Beacon, L-Band, Autonomous, External RTCM
SBAS Tracking	2-channel, parallel tracking
Start up time	~ 60 seconds (no almanac and RTC)
Satellite Reacquisition	< 1 second

* depends on multipath environment, number of satellites in view, satellite geometry, baseline length (for local services) and ionospheric activity

** depends on multipath environment, number of satellites in view, satellite geometry and ionospheric activity.