



TeeJet[®]

TECHNOLOGIES

Catalog 51A

Leaders in precision application components, control system technology, and application data management.



www.teejet.com

A Subsidiary of  **Spraying Systems Co.**[®]

VISIT WWW.TEEJET.COM

COMPANY NEWS • PRODUCT INFORMATION
IMAGE LIBRARY • TECHNICAL SUPPORT

TABLE OF CONTENTS

Selection Guide

TeeJet® Broadcast Nozzle Selection Guide	4
TeeJet Specialty Application Nozzle Selection Guide	5
TeeJet Liquid Fertilizer Nozzle Selection Guide.....	6

Broadcast Nozzles

Turbo TeeJet® Wide Angle Flat Spray Tips	7
AIXR TeeJet Air Induction Flat Spray Tips.....	8
AI TeeJet Air Induction Flat Spray Tips	9
AIC TeeJet Air Induction Flat Spray Tips.....	10
Turbo TeeJet Induction Flat Spray Tips	11
XR TeeJet® Extended Range Flat Spray Tips	12
XRC TeeJet Extended Range Flat Spray Tips.....	13
TeeJet VisiFlo® Flat Spray Tips	14
DG TeeJet® Drift Guard Flat Spray Tips.....	15
Turbo TwinJet® Twin Flat Spray Tips	16
Air Induction Turbo TwinJet Twin Flat Spray Tips.....	17
AI3070® Air Induction Dual Pattern Flat Spray Tips	18
Turbo TeeJet Duo Dual Polymer Flat Fan Spray Tips ..	19
TXR ConeJet® Hollow Cone Spray Tips	20
TwinJet® Twin Flat Spray Tips.....	21
DG TwinJet® Drift Guard Twin Flat Spray Tips.....	22
Turbo FloodJet® Wide Angle Flat Spray Tips	23
Quick Turbo FloodJet Wide Angle Flat Spray Tips.....	24
FloodJet® Wide Angle Flat Spray Tips	25
TurfJet Wide Angle Flat Fan Spray Nozzles.....	26
TeeJet Double Outlet Flat Spray Tips.....	27
TeeJet Off-Center Flat Spray Tips – Smaller Capacities.....	27
FullJet® Wide Angle Full Cone Spray Tips	28

Boomless Nozzles

XP BoomJet® Boomless Flat Spray Nozzles	29
BoomJet® Boomless Nozzles with Extra Wide Flat Spray Projection	30
TeeJet Swivel Spray Nozzles with Off-Center Flat Spray Tips—Larger Capacities.....	30
FieldJet® Boomless Nozzles with Extra Wide Flat Spray Projection.....	31

Banding Nozzles

ConeJet® VisiFlo Hollow Cone Spray Tips	32
AI TeeJet Air Induction Even Flat Spray Tips	33
DG TeeJet Drift Guard Even Flat Spray Tips	34
TeeJet Even Flat Spray Tips	35
TwinJet Even Flat Spray Tips	36
AIUB TeeJet Banding and Directed Spray Nozzles	37
TeeJet Full Cone Spray Tips	38
TeeJet UB—Underleaf Banding Spray Tips.....	38
ConeJet Ceramic VisiFlo Spray Tips	39

Air Blast Nozzles

ConeJet VisiFlo Hollow Cone Spray Tips	40
ConeJet VisiFlo Hollow Cone Spray Tips	41
TXR ConeJet Hollow Cone Spray Tips	42
AITX ConeJet Air Induction Hollow Cone Spray Tip ...	43
ConeJet VisiFlo Hollow Cone Spray Tips	44
TeeJet VisiFlo Flat Spray Tips.....	44
TeeJet Disc-Core Type Hollow Cone Spray Tips.....	45
TeeJet Disc-Core Type Full Cone Spray Tips	46

Fertilizer Nozzles

StreamJet SJ3 Fertilizer Nozzles.....	47
StreamJet SJ7 Fertilizer Nozzles.....	48
TeeJet Flow Regulators	49
StreamJet Solid Stream Spray Nozzles	50

Rinsing & Mixing Nozzles

TeeJet Tank Rinsing Nozzles	51
TeeJet Container Rinsing Nozzles.....	51
TeeJet Eductor Nozzles	52
TeeJet Jet Agitators.....	52

Boom Components

Quick TeeJet® Multiple Nozzle Body Assemblies for Dry Booms	53
Quick TeeJet Multiple Nozzle Body Assemblies with Fertilizer Outlets for Dry Booms	54
Quick TeeJet Single Nozzle Bodies for Dry Booms.....	55
TeeJet Vari-Spacing Clamps for Use on Dry Boom Quick TeeJet Bodies.....	56
Quick TeeJet Multiple Nozzle Body Assemblies	56
Quick TeeJet Multiple Nozzle Bodies for Wet Booms	56–57
Quick TeeJet Triple Nozzle Bodies for Wet Booms	58
Quick TeeJet Multiple Nozzle Body Assemblies with Fertilizer Outlets for Wet Booms.....	58
Quick TeeJet Multiple Nozzle Bodies for Wet Booms	59
Quick TeeJet QJS Series Stackable Nozzle Bodies.....	60–61
Quick TeeJet Single Nozzle Bodies for Wet Booms ...	62



Quick TeeJet Push-to-Connect Caps and Bodies 63
 Quick TeeJet Caps 64–65
 Quick TeeJet Caps for Hardi® Nozzle Bodies 65
 Quick TeeJet Rapid Stop Nozzle Body Adapter 65
 Quick TeeJet Adapters and Accessories 66
 TeeJet ChemSaver® Diaphragm Check Valves 67
 TeeJet Nozzle Body ChemSaver Check Valves 68
 TeeJet Row Application Kit 68
 TeeJet Nozzle Body ChemSaver® Check Valves 69
 TeeJet Specialty Fittings 70
 TeeJet Swivel Nozzle Bodies 71
 TeeJet Hose Drops 71
 TeeJet Hose Shank Nozzle Bodies 72
 TeeJet Split Eyelet Nozzle Bodies 72
 TeeJet Nozzle Parts 73–74

Mobile Electronics

TeeJet 800 Series Flow Meters 75
 TeeJet D Series Flow Meters 75
 TeeJet Automatic Sprayer Controls 76
 TeeJet Manual Sprayer Controls 76
 TeeJet Automatic Sprayer Controls 77
 TeeJet Field Computers 77

Valves & Manifolds

DirectoValve® B Style Electric Motors and Valves 78
 DirectoValve B Style Motors 79
 DirectoValve Electric Regulating Valves 80
 DirectoValve Flow Back Manifolds 81
 DirectoValve Electric Regulating Ball Valves 82–83
 DirectoValve 344 Series Electric Shutoff Valves 84–85

DirectoValve 346 Series Shutoff Valves 86–87
 DirectoValve 356 Series Flanged Shutoff Valves 88–89
 DirectoValve Normally-Open (Bypass) Valves 90–91
 DirectoValve 430 Series 2-Way Manifold 92
 DirectoValve 430 Series 3-Way Manifold 93
 DirectoValve 430 Series Flow Back Manifold 94–95
 DirectoValve Control Unit for TeeJet Controllers 96–97
 Individual 430 Manifold Accessories 97
 DirectoValve 440 Series Manifold Shutoff Valves 98–99
 DirectoValve 450 Series Shutoff Manifold 100–101
 DirectoValve 450 Series Flow Back Manifold 102–103
 DirectoValve 460 Series 2-Way Manifold 104–105
 DirectoValve 460 Series 3-Way Manifold 106–107
 DirectoValve 460 Series Flow Back Manifold 108–109
 DirectoValve 490 Series Shutoff Manifold 110–111
 DirectoValve 540 Series Shutoff Manifold 112–113
 DirectoValve Flange Fittings 114–115
 DirectoValve Quick Connect Fittings 116
 DirectoValve Electrical Connectors 117
 DirectoValve 2-Way Electrically Operated Solenoid Valves 118
 DirectoValve 3-Way Electrically Operated Solenoid Valves 119
 DirectoValve 340 Series 2-Way Manual Shutoff Ball Valves 120
 DirectoValve 340 Series 3-Way Manual Bypass Ball Valves 121
 DirectoValve Manual Pressure Relief/Regulating Valves 122
 DirectoValve Manual Control Valves 123
 TeeValve® Control Valves 123
 TeeJet Throttling Valves 123

Strainers

TeeJet Tip Strainers 124
 TeeJet Line Strainers 124–127

Spray Guns

GunJet® Spray Guns 128–129, 131
 TeeJet Lawn Spray Guns 130
 TriggerJet® Spray Guns 132–133
 ConeJet Adjustable Spray Tips 134
 TeeJet Shutoff Valves and Spray Guns 135

Technical Information

Universal Application Rate Chart 136–138
 Calibration/Adjustment Accessories 139
 Formulas and Factors 140–141
 Spray Coverage Information 141
 Nozzle Nomenclature 141
 Information About Spray Pressure 142
 Pressure Drop Through Sprayer Components 143
 Area Measurement 144
 Sprayer Calibration 145
 Spray Tip Wear 146
 Spray Distribution Quality 147
 Droplet Size and Drift Information 148
 Assessment of Nozzle Drift Control in Europe 149
 Drift Causes and Control 150–151
 Drop Size Classification 152–155
 Plumbing Diagrams 156–157
 Notes 158–159
 Terms and Conditions 160

What's New from



AITTJ60 High-Capacity Air Induction Turbo TwinJet® Tips

See Page 17



AI3070 Air Induction Dual Pattern Flat Spray Tips

See Page 18



XR Extended Range Flat Spray Tips

See Page 12



XR80025



XR80035

TXR ConeJet® Hollow Cone Spray Tips

See Pages 20 & 42



QJ380 & QJ380F High-Capacity Nozzle Bodies

See Page 59



QJS Stackable Nozzle Body

See Pages 60-61





Quick TeeJet® Push to Connect Fittings

See Page 63



AA122QC Quick Connect Line Strainer

See Pages 97 & 124



55295 e-ChemSaver®

See Page 69



Rapid Stop Nozzle Body Adapter

See Page 65



55300 Air ChemSaver®

See Page 69



TeeJet SpraySelect Mobile App

Scan QR to Download







Apple®



Android™

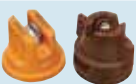

TeeJet® Broadcast Nozzle Selection Guide

	HERBICIDES			FUNGICIDES		INSECTICIDES		DRIFT MANAGEMENT	PWM NOZZLE CONTROL
	SOIL APPLIED	POST-EMERGENCE		CONTACT	SYSTEMIC	CONTACT	SYSTEMIC		
		CONTACT	SYSTEMIC						
 Turbo TeeJet™ Reference page 7		VERY GOOD	VERY GOOD	VERY GOOD	VERY GOOD	VERY GOOD	VERY GOOD	VERY GOOD	EXCELLENT
 Turbo TeeJet™ at pressures below 30 PSI (2.0 bar) Reference page 7	GOOD	GOOD	EXCELLENT	GOOD	EXCELLENT	GOOD	EXCELLENT	VERY GOOD	EXCELLENT
 Turbo TwinJet™ Reference page 16	GOOD	EXCELLENT	EXCELLENT	EXCELLENT	EXCELLENT	EXCELLENT	EXCELLENT	VERY GOOD	EXCELLENT
 Turbo TwinJet™ at pressures below 30 PSI (2.0 bar) Reference page 16	VERY GOOD	VERY GOOD	EXCELLENT	VERY GOOD	EXCELLENT	VERY GOOD	EXCELLENT	EXCELLENT	EXCELLENT
 Turbo TeeJet Induction™ Reference page 11	EXCELLENT		EXCELLENT		EXCELLENT		EXCELLENT	EXCELLENT	
 Air Induction Turbo TwinJet™ Reference page 17	VERY GOOD	GOOD	EXCELLENT	GOOD	EXCELLENT	GOOD	EXCELLENT	EXCELLENT	
 AI3070™ Reference page 18		VERY GOOD	VERY GOOD	EXCELLENT	VERY GOOD	EXCELLENT	VERY GOOD	EXCELLENT	
 XR, XRC TeeJet™ Reference pages 12–13		EXCELLENT	GOOD	EXCELLENT	GOOD	EXCELLENT	GOOD	GOOD	EXCELLENT
 XR, XRC TeeJet™ at pressures below 30 PSI (2.0 bar) Reference pages 12–13	GOOD	GOOD	VERY GOOD	GOOD	VERY GOOD	GOOD	VERY GOOD	VERY GOOD	EXCELLENT
 AIXR TeeJet™ Reference page 8	VERY GOOD	GOOD	EXCELLENT	GOOD	EXCELLENT	GOOD	EXCELLENT	EXCELLENT	
 AI, AIC TeeJet™ Reference pages 9–10	VERY GOOD	GOOD	EXCELLENT	GOOD	EXCELLENT	GOOD	EXCELLENT	EXCELLENT	
 TwinJet™ Reference page 21		EXCELLENT		EXCELLENT		EXCELLENT			GOOD
 DG TwinJet™ Reference page 22	VERY GOOD	VERY GOOD	EXCELLENT	VERY GOOD	EXCELLENT	VERY GOOD	EXCELLENT	VERY GOOD	GOOD
 Turbo FloodJet™ Reference page 23	EXCELLENT		VERY GOOD		VERY GOOD		VERY GOOD	EXCELLENT	
 TurfJet™ Reference page 26	EXCELLENT		EXCELLENT		EXCELLENT		EXCELLENT	EXCELLENT	
 QCTF Turbo FloodJet™ Reference page 24	EXCELLENT							EXCELLENT	

Note: Consult the chemical manufacturer's product label for specific rate and application recommendations.

TeeJet® Specialty Application Nozzle Selection Guide



		HERBICIDES			FUNGICIDES		INSECTICIDES	
		PRE-EMERGENCE	POST-EMERGENCE		CONTACT	SYSTEMIC	CONTACT	SYSTEMIC
			CONTACT	SYSTEMIC				
BANDING	 AI TeeJet^{EVEN} Reference page 33	EXCELLENT	GOOD	EXCELLENT	GOOD	EXCELLENT	GOOD	EXCELLENT
	 TeeJet^{EVEN} Reference page 35	GOOD	VERY GOOD	GOOD	VERY GOOD	GOOD	VERY GOOD	GOOD
	 TwinJet^{EVEN} Reference page 36		EXCELLENT		EXCELLENT		EXCELLENT	
DIRECTED SPRAYING	 AI TeeJet^{EVEN} Reference page 33	VERY GOOD	GOOD	EXCELLENT	GOOD	EXCELLENT	GOOD	EXCELLENT
	 TeeJet^{EVEN} Reference page 35	GOOD	GOOD	GOOD	GOOD	GOOD	GOOD	GOOD
	 TwinJet^{EVEN} Reference page 36		VERY GOOD		VERY GOOD		VERY GOOD	
	 AIUB TeeJet Reference page 37		GOOD	EXCELLENT	GOOD	EXCELLENT	GOOD	EXCELLENT
	 AITX ConeJet Reference page 43		GOOD	EXCELLENT	GOOD	EXCELLENT	GOOD	EXCELLENT
	 ConeJet Reference pages 32 & 39		EXCELLENT		EXCELLENT		EXCELLENT	
AIR BLAST	 ConeJet Reference pages 40–43		EXCELLENT	GOOD	EXCELLENT	GOOD	EXCELLENT	GOOD
	 Disc-Core Reference pages 45–46		EXCELLENT	GOOD	EXCELLENT	GOOD	EXCELLENT	GOOD

Note: Consult the chemical manufacturer's product label for specific rate and application recommendations.



	BROADCAST	DIRECTED
 StreamJet (7-ORIFICE) <i>Reference page 48</i>	EXCELLENT	VERY GOOD
 StreamJet (3-ORIFICE) <i>Reference page 47</i>	VERY GOOD	EXCELLENT
 StreamJet (SINGLE-ORIFICE) <i>Reference page 50</i>		EXCELLENT
 CP4916 (ORIFICE PLATE) <i>Reference page 49</i>		EXCELLENT
 TP TeeJet (LARGE CAPACITY) <i>Reference page 14</i>	VERY GOOD	
 AI TeeJet AIC TeeJet (LOW VOLUME) <i>Reference pages 9–10</i>	VERY GOOD	
 AIUB TeeJet (LOW VOLUME) <i>Reference page 37</i>		VERY GOOD
 Turbo TeeJet Induction <i>Reference page 11</i>	EXCELLENT	
 Turbo FloodJet <i>Reference page 23</i>	EXCELLENT	
 QCTF Turbo FloodJet <i>Reference page 24</i>	EXCELLENT	

LIQUID FERTILIZER APPLICATION

Just as in applying crop protection products, the proper application of liquid fertilizer is important. Delivering nutrients to the crop in a timely and effective manner while minimizing crop damage is essential. TeeJet Technologies offers an extensive selection of nozzles specifically designed to maximize the performance of your liquid fertilizer application.

Solid stream nozzles, offered in both single- and multiple-stream versions, are designed to deliver fertilizer to the soil surface where it can be effectively utilized by the crop. By creating solid liquid streams, these nozzles greatly reduce foliar coverage in standing crop in order to minimize leaf burn. TeeJet Technologies StreamJet nozzles provide the ideal blend of compact, reliable design, ease of installation and affordable pricing.

In some cases, the use of a broadcast nozzle for fertilizer application may be desirable. This could include combined fertilizer/pesticide applications, foliar feeding or broadcast liquid fertilization of bare ground. For these applications TeeJet Technologies offers a wide variety of low drift, flat spray nozzles.

Liquid Density Conversion

When selecting a specific capacity tip for liquid fertilizer application, always correct for liquid density. Application charts shown in this catalog are based on spraying water. Many fertilizer solutions are denser than water, which will affect the application rate. Please see page 125 for a list of density conversion factors.

Example:

Desired application rate is 20 GPA of 28% Nitrogen. Determine the correct nozzle size as follows:

GPA (liquid other than water) x Conversion Factor = GPA (from table in catalog)

$$20 \text{ GPA (28\%)} \times 1.13 = 22.6 \text{ GPA (water)}$$

The applicator should choose a nozzle size that will supply 22.6 GPA of water at the desired pressure.



Note: Consult the chemical manufacturer's product label for specific rate and application recommendations.

Turbo TeeJet® Wide Angle Flat Spray Tips



Typical Applications:

See selection guide on page 4 for recommended typical applications for Turbo TeeJet tips.

Features:

- Tapered edge wide angle flat spray pattern for uniform coverage in broadcast spraying.
- Large, rounded internal passage to minimize clogging.
- Excellent resistance to corrosive solutions.
- Superior wear characteristics.
- Larger droplets for less drift—15–90 PSI (1–6 bar).
- Automatic spray alignment with 25612-^{*}-NYR Quick TeeJet® cap and gasket. Reference page 64 for more information.
- Unique internal configuration means substantially longer wear life.



TIPOLOGY	PSI	DROP SIZE	CAPACITY ONE NOZZLE IN GPM	CAPACITY ONE NOZZLE IN OZ./MIN.	20°															
					GPA								GALLONS PER 1000 SQ. FT.							
					4 MPH	5 MPH	6 MPH	8 MPH	10 MPH	12 MPH	15 MPH	20 MPH	2 MPH	3 MPH	4 MPH	5 MPH				
TT11001 (100)	15	C	0.061	7.8	4.5	3.6	3.0	2.3	1.8	1.5	1.2	0.91	0.21	0.14	0.10	0.08	0.21	0.14	0.10	0.08
	20	C	0.071	9.1	5.3	4.2	3.5	2.6	2.1	1.8	1.4	1.1	0.24	0.16	0.12	0.10	0.24	0.16	0.12	0.10
	30	M	0.087	11	6.5	5.2	4.3	3.2	2.6	2.2	1.7	1.3	0.30	0.20	0.15	0.12	0.30	0.20	0.15	0.12
	40	M	0.10	13	7.4	5.9	5.0	3.7	3.0	2.5	2.0	1.5	0.34	0.23	0.17	0.14	0.34	0.23	0.17	0.14
	50	M	0.11	14	8.2	6.5	5.4	4.1	3.3	2.7	2.2	1.6	0.37	0.25	0.19	0.15	0.37	0.25	0.19	0.15
	60	F	0.12	15	8.9	7.1	5.9	4.5	3.6	3.0	2.4	1.8	0.41	0.27	0.20	0.16	0.41	0.27	0.20	0.16
TT110015 (100)	75	F	0.14	18	10.4	8.3	6.9	5.2	4.2	3.5	2.8	2.1	0.48	0.32	0.24	0.19	0.48	0.32	0.24	0.19
	90	F	0.15	19	11.1	8.9	7.4	5.6	4.5	3.7	3.0	2.2	0.51	0.34	0.26	0.20	0.51	0.34	0.26	0.20
	15	VC	0.092	12	6.8	5.5	4.6	3.4	2.7	2.3	1.8	1.4	0.31	0.21	0.16	0.13	0.31	0.21	0.16	0.13
	20	C	0.11	14	8.2	6.5	5.4	4.1	3.3	2.7	2.2	1.6	0.37	0.25	0.19	0.15	0.37	0.25	0.19	0.15
	30	M	0.13	17	9.7	7.7	6.4	4.8	3.9	3.2	2.6	1.9	0.44	0.29	0.22	0.18	0.44	0.29	0.22	0.18
	40	M	0.15	19	11.1	8.9	7.4	5.6	4.5	3.7	3.0	2.2	0.51	0.34	0.26	0.20	0.51	0.34	0.26	0.20
TT11002 (50)	50	M	0.17	22	12.6	10.1	8.4	6.3	5.0	4.2	3.4	2.5	0.58	0.39	0.29	0.23	0.58	0.39	0.29	0.23
	60	F	0.18	23	13.4	10.7	8.9	6.7	5.3	4.5	3.6	2.7	0.61	0.41	0.31	0.24	0.61	0.41	0.31	0.24
	75	F	0.21	27	15.6	12.5	10.4	7.8	6.2	5.2	4.2	3.1	0.71	0.48	0.36	0.29	0.71	0.48	0.36	0.29
	90	F	0.23	29	17.1	13.7	11.4	8.5	6.8	5.7	4.6	3.4	0.78	0.52	0.39	0.31	0.78	0.52	0.39	0.31
	15	VC	0.12	15	8.9	7.1	5.9	4.5	3.6	3.0	2.4	1.8	0.41	0.27	0.20	0.16	0.41	0.27	0.20	0.16
	20	VC	0.14	18	10.4	8.3	6.9	5.2	4.2	3.5	2.8	2.1	0.48	0.32	0.24	0.19	0.48	0.32	0.24	0.19
TT110025 (50)	30	C	0.17	22	12.6	10.1	8.4	6.3	5.0	4.2	3.4	2.5	0.58	0.39	0.29	0.23	0.58	0.39	0.29	0.23
	40	M	0.20	26	14.9	11.9	9.9	7.4	5.9	5.0	4.0	3.0	0.68	0.45	0.34	0.27	0.68	0.45	0.34	0.27
	50	M	0.22	28	16.3	13.1	10.9	8.2	6.5	5.4	4.4	3.3	0.75	0.50	0.37	0.30	0.75	0.50	0.37	0.30
	60	M	0.24	31	17.8	14.3	11.9	8.9	7.1	5.9	4.8	3.6	0.82	0.54	0.41	0.33	0.82	0.54	0.41	0.33
	75	F	0.27	35	20	16.0	13.4	10.0	8.0	6.7	5.3	4.0	0.92	0.61	0.46	0.37	0.92	0.61	0.46	0.37
	90	F	0.30	38	22	17.8	14.9	11.1	8.9	7.4	5.9	4.5	1.0	0.68	0.51	0.41	1.0	0.68	0.51	0.41
TT11003 (50)	15	VC	0.15	19	11.1	8.9	7.4	5.6	4.5	3.7	3.0	2.2	0.51	0.34	0.26	0.20	0.51	0.34	0.26	0.20
	20	VC	0.18	23	13.4	10.7	8.9	6.7	5.3	4.5	3.6	2.7	0.61	0.41	0.31	0.24	0.61	0.41	0.31	0.24
	30	C	0.22	28	16.3	13.1	10.9	8.2	6.5	5.4	4.4	3.3	0.75	0.50	0.37	0.30	0.75	0.50	0.37	0.30
	40	M	0.25	32	18.6	14.9	12.4	9.3	7.4	6.2	5.0	3.7	0.85	0.57	0.43	0.34	0.85	0.57	0.43	0.34
	50	M	0.28	36	21	16.6	13.9	10.4	8.3	6.9	5.5	4.2	0.95	0.63	0.48	0.38	0.95	0.63	0.48	0.38
	60	M	0.31	40	23	18.4	15.3	11.5	9.2	7.7	6.1	4.6	1.1	0.70	0.53	0.42	1.1	0.70	0.53	0.42
TT11004 (50)	75	F	0.34	44	25	20	16.8	12.6	10.1	8.4	6.7	5.0	1.2	0.77	0.58	0.46	1.2	0.77	0.58	0.46
	90	F	0.38	49	28	23	18.8	14.1	11.3	9.4	7.5	5.6	1.3	0.86	0.65	0.52	1.3	0.86	0.65	0.52
	15	VC	0.18	23	13.4	10.7	8.9	6.7	5.3	4.5	3.6	2.7	0.61	0.41	0.31	0.24	0.61	0.41	0.31	0.24
	20	VC	0.21	27	15.6	12.5	10.4	7.8	6.2	5.2	4.2	3.1	0.71	0.48	0.36	0.29	0.71	0.48	0.36	0.29
	30	C	0.26	33	19.3	15.4	12.9	9.7	7.7	6.4	5.1	3.9	0.88	0.59	0.44	0.35	0.88	0.59	0.44	0.35
	40	C	0.30	38	22	17.8	14.9	11.1	8.9	7.4	5.9	4.5	1.0	0.68	0.51	0.41	1.0	0.68	0.51	0.41
TT11005 (50)	50	M	0.34	44	25	20	16.8	12.6	10.1	8.4	6.7	5.0	1.2	0.77	0.58	0.46	1.2	0.77	0.58	0.46
	60	M	0.37	47	27	22	18.3	13.7	11.0	9.2	7.3	5.5	1.3	0.84	0.63	0.50	1.3	0.84	0.63	0.50
	75	M	0.41	52	30	24	20	15.2	12.2	10.1	8.1	6.1	1.4	0.93	0.70	0.56	1.4	0.93	0.70	0.56
	90	F	0.45	58	33	27	22	16.7	13.4	11.1	8.9	6.7	1.5	1.0	0.77	0.61	1.5	1.0	0.77	0.61
	15	XC	0.24	31	17.8	14.3	11.9	8.9	7.1	5.9	4.8	3.6	0.82	0.54	0.41	0.33	0.82	0.54	0.41	0.33
	20	VC	0.28	36	21	16.6	13.9	10.4	8.3	6.9	5.5	4.2	0.95	0.63	0.48	0.38	0.95	0.63	0.48	0.38
TT11006 (50)	30	C	0.35	45	26	21	17.3	13.0	10.4	8.7	6.9	5.2	1.2	0.79	0.60	0.48	1.2	0.79	0.60	0.48
	40	C	0.40	51	30	24	19.8	14.9	11.9	9.9	7.9	5.9	1.4	0.91	0.68	0.54	1.4	0.91	0.68	0.54
	50	M	0.45	58	33	27	22	16.7	13.4	11.1	8.9	6.7	1.5	1.0	0.77	0.61	1.5	1.0	0.77	0.61
	60	M	0.49	63	36	29	24	18.2	14.6	12.1	9.7	7.3	1.7	1.1	0.83	0.67	1.7	1.1	0.83	0.67
	75	M	0.55	70	41	33	27	20	16.3	13.6	10.9	8.2	1.9	1.2	0.94	0.75	1.9	1.2	0.94	0.75
	90	M	0.60	77	45	36	30	22	17.8	14.9	11.9	8.9	2.0	1.4	1.0	0.82	2.0	1.4	1.0	0.82
TT11008 (50)	15	XC	0.31	40	23	18.4	15.3	11.5	9.2	7.7	6.1	4.6	1.1	0.70	0.53	0.42	1.1	0.70	0.53	0.42
	20	VC	0.35	45	26	21	17.3	13.0	10.4	8.7	6.9	5.2	1.2	0.79	0.60	0.48	1.2	0.79	0.60	0.48
	30	C	0.43	55	32	26	21	16.0	12.8	10.6	8.5	6.4	1.5	0.97	0.73	0.58	1.5	0.97	0.73	0.58
	40	C	0.50	64	37	30	25	18.6	14.9	12.4	9.9	7.4	1.7	1.1	0.85	0.68	1.7	1.1	0.85	0.68
	50	C	0.56	72	42	33	28	21	16.6	13.9	11.1	8.3	1.9	1.3	0.95	0.76	1.9	1.3	0.95	0.76
	60	M	0.61	78	45	36	30	23	18.1	15.1	12.1	9.1	2.1	1.4	1.0	0.83	2.1	1.4	1.0	0.83
TT11008 (50)	75	M	0.68	87	50	40	34	25	20	16.8	13.5	10.1	2.3	1.5	1.2	0.92	2.3	1.5	1.2	0.92
	90	M	0.75	96	56	45	37	28	22	18.6	14.9	11.1	2.6	1.7	1.3	1.0	2.6	1.7	1.3	1.0
	15	XC	0.37	47	27	22	18.3	13.7	11.0	9.2	7.3	5.5	1.3	0.84	0.63	0.50	1.3	0.84	0.63	0.50
	20	VC	0.42	54	31	25	21	15.6	12.5	10.4	8.3	6.2	1.4	0.95	0.71	0.57	1.4	0.95	0.71	0.57
	30	VC	0.52	67	39	31	26	19.3	15.4	12.9	10.3	7.7	1.8	1.2	0.88	0.71	1.8	1.2	0.88	0.71
	40	VC	0.60	77	45	36	30	22	17.8	14.9	11.9	8.9	2.0	1.4	1.0	0.82	2.0	1.4	1.0	0.82
TT11008 (50)	50	C	0.67	86	50	40	33	25	19.9	16.6	13.3	9.9	2.3	1.5	1.1	0.91	2.3	1.5	1.1	0.91
	60	C	0.73	93	54	43	36	27	22	18.1	14.5	10.8	2.5	1.7	1.2	0.99	2.5	1.7	1.2	0.99
	75	C	0.82	105	61	49	41	30	24	20	16.2	12.2	2.8	1.9	1.4	1.1	2.8	1.9	1.4	1.1
	90	M	0.90	115	67	53	45	33	27	22	17.8	13.4	3.1	2.0	1.5	1.2	3.1	2.0	1.5	1.2
	15	XC	0.49	63	36	29	24	18.2	14.6	12.1	9.7	7.3	1.7	1.1	0.83	0.67	1.7	1.1	0.83	0.67
	20	VC	0.57	73	42	34	28	21	16.9	14.1	11.3	8.5	1.9	1.3	0.97	0.78	1.9	1.3	0.97	0.78
TT11008 (50)	30																			



AIXR TeeJet® Air Induction XR Flat Spray Tips

Typical Applications:

See selection guide on page 4 for recommended typical applications for AIXR TeeJet tips.

Features:

- 110° wide, tapered flat spray angle with air induction technology offers better drift management.
- Made of a two-piece UHMWPE polymer construction with VisiFlo® color-coding. UHMWPE provides excellent chemical resistance, including acids, as well as exceptional wear life.

- Compact size to prevent tip damage.
- Depending on the chemical, produces large air-filled drops through a Venturi air aspirator.
- Removable pre-orifice.
- Available in seven tip capacities with a wide operating pressure range: 15–90 PSI (1–6 bar).
- Automatic alignment when used with 25612-*.NYR Quick TeeJet® cap and gasket. Reference page 64 for more information.



PSI	DROPSIZE	CAPACITY ONE NOZZLE IN GPM	CAPACITY ONE NOZZLE IN OZ./MIN.	20°										GALLONS PER 1000 SQ. FT.				
				GPA														
				4 MPH	5 MPH	6 MPH	8 MPH	10 MPH	12 MPH	15 MPH	20 MPH	2 MPH	3 MPH	4 MPH	5 MPH			
AIXR110015 (100)	15	XC	0.092	12	6.8	5.5	4.6	3.4	2.7	2.3	1.8	1.4	0.31	0.21	0.16	0.13		
	20	XC	0.11	14	8.2	6.5	5.4	4.1	3.3	2.7	2.2	1.6	0.37	0.25	0.19	0.15		
	30	C	0.13	17	9.7	7.7	6.4	4.8	3.9	3.2	2.6	1.9	0.44	0.29	0.22	0.18		
	40	C	0.15	19	11.1	8.9	7.4	5.6	4.5	3.7	3.0	2.2	0.51	0.34	0.26	0.20		
	50	C	0.17	22	12.6	10.1	8.4	6.3	5.0	4.2	3.4	2.5	0.58	0.39	0.29	0.23		
	60	M	0.18	23	13.4	10.7	8.9	6.7	5.3	4.5	3.6	2.7	0.61	0.41	0.31	0.24		
AIXR11002 (50)	75	M	0.21	27	15.6	12.5	10.4	7.8	6.2	5.2	4.2	3.1	0.71	0.48	0.36	0.29		
	90	M	0.23	29	17.1	13.7	11.4	8.5	6.8	5.7	4.6	3.4	0.78	0.52	0.39	0.31		
	15	XC	0.12	15	8.9	7.1	5.9	4.5	3.6	3.0	2.4	1.8	0.41	0.27	0.20	0.16		
	20	XC	0.14	18	10.4	8.3	6.9	5.2	4.2	3.5	2.8	2.1	0.48	0.32	0.24	0.19		
	30	VC	0.17	22	12.6	10.1	8.4	6.3	5.0	4.2	3.4	2.5	0.58	0.39	0.29	0.23		
	40	C	0.20	26	14.9	11.9	9.9	7.4	5.9	5.0	4.0	3.0	0.68	0.45	0.34	0.27		
AIXR110025 (50)	50	C	0.22	28	16.3	13.1	10.9	8.2	6.5	5.4	4.4	3.3	0.75	0.50	0.37	0.30		
	60	C	0.24	31	17.8	14.3	11.9	8.9	7.1	5.9	4.8	3.6	0.82	0.54	0.41	0.33		
	75	M	0.27	35	20	16.0	13.4	10.0	8.0	6.7	5.3	4.0	0.92	0.61	0.46	0.37		
	90	M	0.30	38	22	17.8	14.9	11.1	8.9	7.4	5.9	4.5	1.0	0.68	0.51	0.41		
	15	XC	0.15	19	11.1	8.9	7.4	5.6	4.5	3.7	3.0	2.2	0.51	0.34	0.26	0.20		
	20	XC	0.18	23	13.4	10.7	8.9	6.7	5.3	4.5	3.6	2.7	0.61	0.41	0.31	0.24		
AIXR11003 (50)	30	XC	0.22	28	16.3	13.1	10.9	8.2	6.5	5.4	4.4	3.3	0.75	0.50	0.37	0.30		
	40	VC	0.25	32	18.6	14.9	12.4	9.3	7.4	6.2	5.0	3.7	0.85	0.57	0.43	0.34		
	50	C	0.28	36	21	16.6	13.9	10.4	8.3	6.9	5.5	4.2	0.95	0.63	0.48	0.38		
	60	C	0.31	40	23	18.4	15.3	11.5	9.2	7.7	6.1	4.6	1.1	0.70	0.53	0.42		
	75	C	0.34	44	25	20	16.8	12.6	10.1	8.4	6.7	5.0	1.2	0.77	0.58	0.46		
	90	C	0.38	49	28	23	18.8	14.1	11.3	9.4	7.5	5.6	1.3	0.86	0.65	0.52		
AIXR11004 (50)	15	XC	0.18	23	13.4	10.7	8.9	6.7	5.3	4.5	3.6	2.7	0.61	0.41	0.31	0.24		
	20	XC	0.21	27	15.6	12.5	10.4	7.8	6.2	5.2	4.2	3.1	0.71	0.48	0.36	0.29		
	30	XC	0.26	33	19.3	15.4	12.9	9.7	7.7	6.4	5.1	3.9	0.88	0.59	0.44	0.35		
	40	VC	0.30	38	22	17.8	14.9	11.1	8.9	7.4	5.9	4.5	1.0	0.68	0.51	0.41		
	50	C	0.34	44	25	20	16.8	12.6	10.1	8.4	6.7	5.0	1.2	0.77	0.58	0.46		
	60	C	0.37	47	27	22	18.3	13.7	11.0	9.2	7.3	5.5	1.3	0.84	0.63	0.50		
AIXR11005 (50)	75	C	0.41	52	30	24	20	15.2	12.2	10.1	8.1	6.1	1.4	0.93	0.70	0.56		
	90	C	0.45	58	33	27	22	16.7	13.4	11.1	8.9	6.7	1.5	1.0	0.77	0.61		
	15	UC	0.24	31	17.8	14.3	11.9	8.9	7.1	5.9	4.8	3.6	0.82	0.54	0.41	0.33		
	20	XC	0.28	36	21	16.6	13.9	10.4	8.3	6.9	5.5	4.2	0.95	0.63	0.48	0.38		
	30	XC	0.35	45	26	21	17.3	13.0	10.4	8.7	6.9	5.2	1.2	0.79	0.60	0.48		
	40	XC	0.40	51	30	24	19.8	14.9	11.9	9.9	7.9	5.9	1.4	0.91	0.68	0.54		
AIXR11006 (50)	50	VC	0.45	58	33	27	22	16.7	13.4	11.1	8.9	6.7	1.5	1.0	0.77	0.61		
	60	VC	0.49	63	36	29	24	18.2	14.6	12.1	9.7	7.3	1.7	1.1	0.83	0.67		
	75	C	0.55	70	41	33	27	20	16.3	13.6	10.9	8.2	1.9	1.2	0.94	0.75		
	90	C	0.60	77	45	36	30	22	17.8	14.9	11.9	8.9	2.0	1.4	1.0	0.82		
	15	UC	0.31	40	23	18.4	15.3	11.5	9.2	7.7	6.1	4.6	1.1	0.70	0.53	0.42		
	20	XC	0.35	45	26	21	17.3	13.0	10.4	8.7	6.9	5.2	1.2	0.79	0.60	0.48		
AIXR11005 (50)	30	XC	0.43	55	32	26	21	16.0	12.8	10.6	8.5	6.4	1.5	0.97	0.73	0.58		
	40	XC	0.50	64	37	30	25	18.6	14.9	12.4	9.9	7.4	1.7	1.1	0.85	0.68		
	50	VC	0.56	72	42	33	28	21	16.6	13.9	11.1	8.3	1.9	1.3	0.95	0.76		
	60	VC	0.61	78	45	36	30	23	18.1	15.1	12.1	9.1	2.1	1.4	1.0	0.83		
	75	C	0.68	87	50	40	34	25	20	16.8	13.5	10.1	2.3	1.5	1.2	0.92		
	90	C	0.75	96	56	45	37	28	22	18.6	14.9	11.1	2.6	1.7	1.3	1.0		
AIXR11006 (50)	15	UC	0.37	47	27	22	18.3	13.7	11.0	9.2	7.3	5.5	1.3	0.84	0.63	0.50		
	20	XC	0.42	54	31	25	21	15.6	12.5	10.4	8.3	6.2	1.4	0.95	0.71	0.57		
	30	XC	0.52	67	39	31	26	19.3	15.4	12.9	10.3	7.7	1.8	1.2	0.88	0.71		
	40	XC	0.60	77	45	36	30	22	17.8	14.9	11.9	8.9	2.0	1.4	1.0	0.82		
	50	VC	0.67	86	50	40	33	25	19.9	16.6	13.3	9.9	2.3	1.5	1.1	0.91		
	60	VC	0.73	93	54	43	36	27	22	18.1	14.5	10.8	2.5	1.7	1.2	0.99		
AIXR11006 (50)	75	C	0.82	105	61	49	41	30	24	20	16.2	12.2	2.8	1.9	1.4	1.1		
	90	C	0.90	115	67	53	45	33	27	22	17.8	13.4	3.1	2.0	1.5	1.2		

Note: Always double check your application rates. Tabulations are based on spraying water at 70°F (21°C). See pages 136–157 for drop size classification, useful formulas and other information.

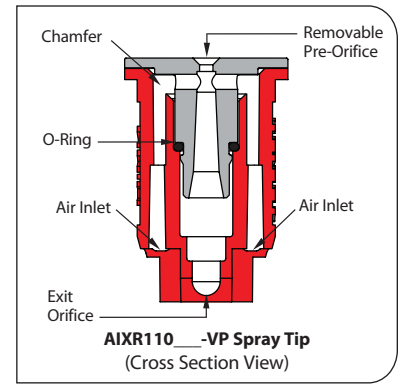

CONTACT PRODUCT	SYSTEMIC PRODUCT	DRIFT MANAGEMENT
GOOD	EXCELLENT	EXCELLENT

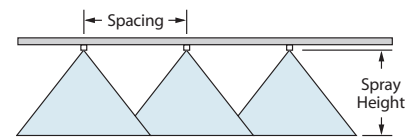

Optimum Spray Height

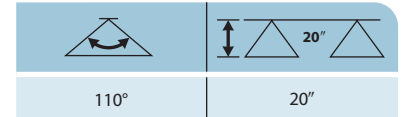

How to order:

Specify tip number.

Example:

- AIXR11004VP – Polymer with VisiFlo color-coding
- AIXR11003VP-C – Polymer with VisiFlo color-coding, Includes Quick TeeJet cap and gasket

AI TeeJet® Air Induction Flat Spray Tips



Typical Applications:

See selection guide on page 4 for recommended typical applications for AI TeeJet tips.

■ Depending on the chemical, produces large air-filled drops through the use of a Venturi air aspirator.

■ Automatic spray alignment with 25598*-NYR Quick TeeJet® cap and gasket. Reference page 64 for more information.

Features:

- Stainless steel insert produces a tapered edge flat spray pattern for uniform coverage in broadcast spraying.
- Polymer insert holder and pre-orifice with VisiFlo® color-coding.
- Larger droplets for less drift.
- Available in eight capacities with a recommended pressure rating 30–115 PSI (2–8 bar).



Tip Model	PSI	DROP SIZE		CAPACITY ONE NOZZLE IN GPM	CAPACITY ONE NOZZLE IN OZ./MIN.	GPA								GALLONS PER 1000 SQ. FT.			
		80°	110°			4 MPH	5 MPH	6 MPH	8 MPH	10 MPH	12 MPH	15 MPH	20 MPH	2 MPH	3 MPH	4 MPH	5 MPH
						UC	XC	VC	C	UC	XC	VC	C	UC	XC	VC	C
AI80015 AI110015 (100)	30	UC	UC	0.13	17	9.7	7.7	6.4	4.8	3.9	3.2	2.6	1.9	0.44	0.29	0.22	0.18
	40	XC	XC	0.15	19	11.1	8.9	7.4	5.6	4.5	3.7	3.0	2.2	0.51	0.34	0.26	0.20
	50	XC	XC	0.17	22	12.6	10.1	8.4	6.3	5.0	4.2	3.4	2.5	0.58	0.39	0.29	0.23
	60	XC	VC	0.18	23	13.4	10.7	8.9	6.7	5.3	4.5	3.6	2.7	0.61	0.41	0.31	0.24
	70	VC	VC	0.20	26	14.9	11.9	9.9	7.4	5.9	5.0	4.0	3.0	0.68	0.45	0.34	0.27
AI8002 AI11002 (50)	30	UC	UC	0.17	22	12.6	10.1	8.4	6.3	5.0	4.2	3.4	2.5	0.58	0.39	0.29	0.23
	40	XC	XC	0.20	26	14.9	11.9	9.9	7.4	5.9	5.0	4.0	3.0	0.68	0.45	0.34	0.27
	50	XC	XC	0.22	28	16.3	13.1	10.9	8.2	6.5	5.4	4.4	3.3	0.75	0.50	0.37	0.30
	60	XC	VC	0.24	31	17.8	14.3	11.9	8.9	7.1	5.9	4.8	3.6	0.82	0.54	0.41	0.33
	70	VC	VC	0.26	33	19.3	15.4	12.9	9.7	7.7	6.4	5.1	3.9	0.88	0.59	0.44	0.35
AI80025 AI110025 (50)	30	UC	UC	0.22	28	16.3	13.1	10.9	8.2	6.5	5.4	4.4	3.3	0.75	0.50	0.37	0.30
	40	XC	XC	0.25	32	18.6	14.9	12.4	9.3	7.4	6.2	5.0	3.7	0.85	0.57	0.43	0.34
	50	XC	XC	0.28	36	21	16.6	13.9	10.4	8.3	6.9	5.5	4.2	0.95	0.63	0.48	0.38
	60	XC	VC	0.31	40	23	18.4	15.3	11.5	9.2	7.7	6.1	4.6	1.1	0.70	0.53	0.42
	70	VC	VC	0.33	42	25	19.6	16.3	12.3	9.8	8.2	6.5	4.9	1.1	0.75	0.56	0.45
AI8003 AI11003 (50)	30	UC	UC	0.26	33	19.3	15.4	12.9	9.7	7.7	6.4	5.1	3.9	0.88	0.59	0.44	0.35
	40	XC	XC	0.30	38	22	17.8	14.9	11.1	8.9	7.4	5.9	4.5	1.0	0.68	0.51	0.41
	50	XC	XC	0.34	44	25	20	16.8	12.6	10.1	8.4	6.7	5.0	1.2	0.77	0.58	0.46
	60	XC	VC	0.37	47	27	22	18.3	13.7	11.0	9.2	7.3	5.5	1.3	0.84	0.63	0.50
	70	VC	VC	0.40	51	30	24	19.8	14.9	11.9	9.9	7.9	5.9	1.4	0.91	0.68	0.54
AI8004 AI11004 (50)	30	UC	UC	0.35	45	26	21	17.3	13.0	10.4	8.7	6.9	5.2	1.2	0.79	0.60	0.48
	40	XC	XC	0.40	51	30	24	19.8	14.9	11.9	9.9	7.9	5.9	1.4	0.91	0.68	0.54
	50	XC	XC	0.45	58	33	27	22	16.7	13.4	11.1	8.9	6.7	1.5	1.0	0.77	0.61
	60	XC	VC	0.49	63	36	29	24	18.2	14.6	12.1	9.7	7.3	1.7	1.1	0.83	0.67
	70	VC	VC	0.53	68	39	31	26	19.7	15.7	13.1	10.5	7.9	1.8	1.2	0.90	0.72
AI8005 AI11005 (50)	30	UC	UC	0.43	55	32	26	21	16.0	12.8	10.6	8.5	6.4	1.5	0.97	0.73	0.58
	40	XC	XC	0.50	64	37	30	25	18.6	14.9	12.4	9.9	7.4	1.7	1.1	0.85	0.68
	50	XC	VC	0.56	72	42	33	28	21	16.6	13.9	11.1	8.3	1.9	1.3	0.95	0.76
	60	XC	VC	0.61	78	45	36	30	23	18.1	15.1	12.1	9.1	2.1	1.4	1.0	0.83
	70	VC	VC	0.66	84	49	39	33	25	19.6	16.3	13.1	9.8	2.2	1.5	1.1	0.90
AI8006 AI11006 (50)	30	UC	UC	0.52	67	39	31	26	19.3	15.4	12.9	10.3	7.7	1.8	1.2	0.88	0.71
	40	XC	XC	0.60	77	45	36	30	22	17.8	14.9	11.9	8.9	2.0	1.4	1.0	0.82
	50	XC	VC	0.67	86	50	40	33	25	19.9	16.6	13.3	9.9	2.3	1.5	1.1	0.91
	60	XC	VC	0.73	93	54	43	36	27	22	18.1	14.5	10.8	2.5	1.7	1.2	0.99
	70	VC	VC	0.79	101	59	47	39	29	23	19.6	15.6	11.7	2.7	1.8	1.3	1.1
AI11008 (50)	30	UC	UC	0.69	88	51	41	34	26	20	17.1	13.7	10.2	2.3	1.6	1.2	0.94
	40	XC	XC	0.80	102	59	48	40	30	24	19.8	15.8	11.9	2.7	1.8	1.4	1.1
	50	XC	VC	0.89	114	66	53	44	33	26	22	17.6	13.2	3.0	2.0	1.5	1.2
	60	XC	VC	0.98	125	73	58	49	36	29	24	19.4	14.6	3.3	2.2	1.7	1.3
	70	VC	VC	1.06	136	79	63	52	39	31	26	21	15.7	3.6	2.4	1.8	1.4
80	VC	VC	1.13	145	84	67	56	42	34	28	22	16.8	3.8	2.6	1.9	1.5	
90	VC	VC	1.20	154	89	71	59	45	36	30	24	17.8	4.1	2.7	2.0	1.6	
100	VC	VC	1.26	161	94	75	62	47	37	31	25	18.7	4.3	2.9	2.1	1.7	

Note: Always double check your application rates. Tabulations are based on spraying water at 70°F (21°C). See pages 136–157 for drop size classification, useful formulas and other information.



Note: Due to the pre-orifice design, this tip is not compatible with the 4193A check valve tip strainer.

CONTACT PRODUCT	SYSTEMIC PRODUCT	DRIFT MANAGEMENT
GOOD	EXCELLENT	EXCELLENT

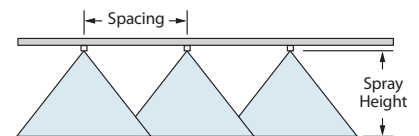

Optimum Spray Height

Tip Angle	Optimum Spray Height
80°	30"
110°	20"

How to order:

Specify tip number.

Example:

AI11004-VS – Stainless Steel with VisiFlo color-coding



AIC TeeJet[®] Air Induction Flat Spray Tips

Typical Applications:

See selection guide on page 4 for recommended typical applications for AIC TeeJet tips.

Features:

■ Produces a 110° tapered edge flat spray pattern for uniform coverage in broadcast spraying applications.

■ Available with a polymer insert holder with stainless steel (015–15 capacities), ceramic (025–05 capacities) or polymer (02–10 capacities) inserts.

■ Larger droplets for less drift.

■ Depending on the chemical, produces large air-filled drops through the use of a Venturi air aspirator.

■ All TeeJet nozzle molded into Quick TeeJet[®] cap provides automatic spray alignment.

■ Includes tightly fitting washer that stays put and assures a good seal.

■ Recommended pressure rating 30–115 PSI (2–8 bar).



Note: Due to the pre-orifice design, this tip is not compatible with the 4193A check valve tip strainer.

PSI	DROPSIZE	CAPACITY ONE NOZZLE IN GPM	CAPACITY ONE NOZZLE IN OZ./MIN.	20°											
				GPA								GALLONS PER 1000 SQ. FT.			
				4 MPH	5 MPH	6 MPH	8 MPH	10 MPH	12 MPH	15 MPH	20 MPH	2 MPH	3 MPH	4 MPH	5 MPH
AIC110015 (100)															
30	UC	0.13	17	9.7	7.7	6.4	4.8	3.9	3.2	2.6	1.9	0.44	0.29	0.22	0.18
40	XC	0.15	19	11.1	8.9	7.4	5.6	4.5	3.7	3.0	2.2	0.51	0.34	0.26	0.20
50	XC	0.17	22	12.6	10.1	8.4	6.3	5.0	4.2	3.4	2.5	0.58	0.39	0.29	0.23
60	VC	0.18	23	13.4	10.7	8.9	6.7	5.3	4.5	3.6	2.7	0.61	0.41	0.31	0.24
70	VC	0.20	26	14.9	11.9	9.9	7.4	5.9	5.0	4.0	3.0	0.68	0.45	0.34	0.27
80	VC	0.21	27	15.6	12.5	10.4	7.8	6.2	5.2	4.2	3.1	0.71	0.48	0.36	0.29
90	C	0.23	29	17.1	13.7	11.4	8.5	6.8	5.7	4.6	3.4	0.78	0.52	0.39	0.31
100	C	0.24	31	17.8	14.3	11.9	8.9	7.1	5.9	4.8	3.6	0.82	0.54	0.41	0.33
AIC11002 (50)															
30	UC	0.17	22	12.6	10.1	8.4	6.3	5.0	4.2	3.4	2.5	0.58	0.39	0.29	0.23
40	XC	0.20	26	14.9	11.9	9.9	7.4	5.9	5.0	4.0	3.0	0.68	0.45	0.34	0.27
50	XC	0.22	28	16.3	13.1	10.9	8.2	6.5	5.4	4.4	3.3	0.75	0.50	0.37	0.30
60	VC	0.24	31	17.8	14.3	11.9	8.9	7.1	5.9	4.8	3.6	0.82	0.54	0.41	0.33
70	VC	0.26	33	19.3	15.4	12.9	9.7	7.7	6.4	5.1	3.9	0.88	0.59	0.44	0.35
80	VC	0.28	36	21	16.6	13.9	10.4	8.3	6.9	5.5	4.2	1.0	0.63	0.48	0.38
90	VC	0.30	38	22	17.8	14.9	11.1	8.9	7.4	5.9	4.5	1.0	0.68	0.51	0.41
100	C	0.32	41	24	19.0	15.8	11.9	9.5	7.9	6.3	4.8	1.1	0.73	0.54	0.44
AIC110025 (50)															
30	UC	0.22	28	16.3	13.1	10.9	8.2	6.5	5.4	4.4	3.3	0.75	0.50	0.37	0.30
40	XC	0.25	32	18.6	14.9	12.4	9.3	7.4	6.2	5.0	3.7	0.85	0.57	0.43	0.34
50	XC	0.28	36	21	16.6	13.9	10.4	8.3	6.9	5.5	4.2	0.95	0.63	0.48	0.38
60	XC	0.31	40	23	18.4	15.3	11.5	9.2	7.7	6.1	4.6	1.1	0.70	0.53	0.42
70	VC	0.33	42	25	19.6	16.3	12.3	9.8	8.2	6.5	4.9	1.1	0.75	0.56	0.45
80	VC	0.35	45	26	21	17.3	13.0	10.4	8.7	6.9	5.2	1.2	0.79	0.60	0.48
90	VC	0.38	49	28	23	18.8	14.1	11.3	9.4	7.5	5.6	1.3	0.86	0.65	0.52
100	C	0.40	51	30	24	19.8	14.9	11.9	9.9	7.9	5.9	1.4	0.91	0.68	0.54
AIC11003 (50)															
30	UC	0.26	33	19.3	15.4	12.9	9.7	7.7	6.4	5.1	3.9	0.88	0.59	0.44	0.35
40	XC	0.30	38	22	17.8	14.9	11.1	8.9	7.4	5.9	4.5	1.0	0.68	0.51	0.41
50	XC	0.34	44	25	20	16.8	12.6	10.1	8.4	6.7	5.0	1.2	0.77	0.58	0.46
60	XC	0.37	47	27	22	18.3	13.7	11.0	9.2	7.3	5.5	1.3	0.84	0.63	0.50
70	VC	0.40	51	30	24	19.8	14.9	11.9	9.9	7.9	5.9	1.4	0.91	0.68	0.54
80	VC	0.42	54	31	25	21	15.6	12.5	10.4	8.3	6.2	1.4	0.95	0.71	0.57
90	VC	0.45	58	33	27	22	16.7	13.4	11.1	8.9	6.7	1.5	1.0	0.77	0.61
100	C	0.47	60	35	28	23	17.4	14.0	11.6	9.3	7.0	1.6	1.1	0.80	0.64
AIC11004 (50)															
30	UC	0.35	45	26	21	17.3	13.0	10.4	8.7	6.9	5.2	1.2	0.79	0.60	0.48
40	XC	0.40	51	30	24	19.8	14.9	11.9	9.9	7.9	5.9	1.4	0.91	0.68	0.54
50	XC	0.45	58	33	27	22	16.7	13.4	11.1	8.9	6.7	1.5	1.0	0.77	0.61
60	XC	0.49	63	36	29	24	18.2	14.6	12.1	9.7	7.3	1.7	1.1	0.83	0.67
70	VC	0.53	68	39	31	26	19.7	15.7	13.1	10.5	7.9	1.8	1.2	0.90	0.72
80	VC	0.57	73	42	34	28	21	16.9	14.1	11.3	8.5	1.9	1.3	0.97	0.78
90	VC	0.60	77	45	36	30	22	17.8	14.9	11.9	8.9	2.0	1.4	1.0	0.82
100	C	0.63	81	47	37	31	23	18.7	15.6	12.5	9.4	2.1	1.4	1.1	0.86
AIC11005 (50)															
30	UC	0.43	55	32	26	21	16.0	12.8	10.6	8.5	6.4	1.5	0.97	0.73	0.58
40	XC	0.50	64	37	30	25	18.6	14.9	12.4	9.9	7.4	1.7	1.1	0.85	0.68
50	XC	0.56	72	42	33	28	21	16.6	13.9	11.1	8.3	1.9	1.3	0.95	0.76
60	XC	0.61	78	45	36	30	23	18.1	15.1	12.1	9.1	2.1	1.4	1.0	0.83
70	VC	0.66	84	49	39	33	25	19.6	16.3	13.1	9.8	2.2	1.5	1.1	0.90
80	VC	0.71	91	53	42	35	26	21	17.6	14.1	10.5	2.4	1.6	1.2	0.97
90	VC	0.75	96	56	45	37	28	22	18.6	14.9	11.1	2.6	1.7	1.3	1.0
100	VC	0.79	101	59	47	39	29	23	19.6	15.6	11.7	2.7	1.8	1.3	1.1
AIC11006 (50)															
30	UC	0.52	67	39	31	26	19.3	15.4	12.9	10.3	7.7	1.8	1.2	0.88	0.71
40	UC	0.60	77	45	36	30	22	17.8	14.9	11.9	8.9	2.0	1.4	1.0	0.82
50	XC	0.67	86	50	40	33	25	19.9	16.6	13.3	9.9	2.3	1.5	1.1	0.91
60	XC	0.73	93	54	43	36	27	22	18.1	14.5	10.8	2.5	1.7	1.2	0.99
70	XC	0.79	101	59	47	39	29	23	19.6	15.6	11.7	2.7	1.8	1.3	1.1
80	VC	0.85	109	63	50	42	32	25	21	16.8	12.6	2.9	1.9	1.4	1.2
90	VC	0.90	115	67	53	45	33	27	22	17.8	13.4	3.1	2.0	1.5	1.2
100	VC	0.95	122	71	56	47	35	28	24	18.8	14.1	3.2	2.2	1.6	1.3
AIC11008 (50)															
30	UC	0.69	88	51	41	34	26	20	17.1	13.7	10.2	2.3	1.6	1.2	0.94
40	UC	0.80	102	59	48	40	30	24	19.8	15.8	11.9	2.7	1.8	1.4	1.1
50	XC	0.89	114	66	53	44	33	26	22	17.6	13.2	3.0	2.0	1.5	1.2
60	XC	0.98	125	73	58	49	36	29	24	19.4	14.6	3.3	2.2	1.7	1.3
70	XC	1.06	136	79	63	52	39	31	26	21	15.7	3.6	2.4	1.8	1.4
80	VC	1.13	145	84	67	56	42	34	28	22	16.8	3.8	2.6	1.9	1.5
90	VC	1.20	154	89	71	59	45	36	30	24	17.8	4.1	2.7	2.0	1.6
100	VC	1.26	161	94	75	62	47	37	31	25	18.7	4.3	2.9	2.1	1.7
AIC11010															
30	UC	0.87	111	65	52	43	32	26	22	17.2	12.9	3.0	2.0	1.5	1.2
40	UC	1.00	128	74	59	50	37	30	25	19.8	14.9	3.4	2.3	1.7	1.4
50	XC	1.12	143	83	67	55	42	33	28	22	16.6	3.8	2.5	1.9	1.5
60	XC	1.22	156	91	72	60	45	36	30	24	18.1	4.1	2.8	2.1	1.7
70	XC	1.32	169	98	78	65	49	39	33	26	19.6	4.5	3.0	2.2	1.8
80	XC	1.41	180	105	84	70	52	42	35	28	21	4.8	3.2	2.4	1.9
90	VC	1.50	192	111	89	74	56	45	37	30	22	5.1	3.4	2.6	2.0
100	VC	1.58	202	117	94	78	59	47	39	31	23	5.4	3.6	2.7	2.1
AIC11015															
30	UC	1.30	166	97	77	64	48	39	32	26	19.3	4.4	2.9	2.2	1.8
40	UC	1.50	192	111	89	74	56	45	37	30	22	5.1	3.4	2.6	2.0
50	XC	1.68	215	125	100	83	62	50	42	33	25	5.7	3.8	2.9	2.3
60	XC	1.84	236	137	109	91	68	55	46	36	27	6.3	4.2	3.1	2.5
70	XC	1.98	253	147	118	98	74	59	49	39	29	6.7	4.5	3.4	2.7
80	XC	2.12	271	157	126	105	79	63	52	42	31	7.2	4.8	3.6	2.9
90	VC	2.25	288	167	134	111	84	67	56	45	33	7.7	5.1	3.8	3.1
100	VC	2.37	303	176	141	117	88	70	59	47	35	8.1	5.4	4.0	3.2



CONTACT PRODUCT	SYSTEMIC PRODUCT	DRIFT MANAGEMENT
GOOD	EXCELLENT	EXCELLENT

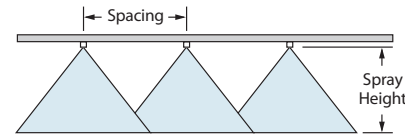

Optimum Spray Height

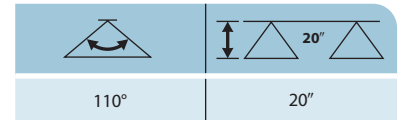

How to order:

Specify tip number.

Examples:

- AIC11004-VS – Stainless Steel with VisiFlo[®] color-coding
- AIC11003-VP – Polymer with VisiFlo color-coding
- AIC11003-VK – Ceramic with VisiFlo color-coding

Note: Always double check your application rates. Tabulations are based on spraying water at 70°F (21°C). See pages 136–157 for drop size

Turbo TeeJet® Induction Flat Spray Tips



Typical Applications:

See selection guide on page 4 for recommended typical applications for Turbo TeeJet Induction tips.

Features:

- 110° wide angle, air induction, tapered flat spray tip pattern based on the patented outlet orifice design of the original Turbo TeeJet® nozzle.
- Patented orifice design provides large, round passages to minimize plugging.
- Depending on the chemical, produces large air-filled drops through a Venturi air aspirator resulting in less drift.
- All polymer construction for excellent chemical and wear resistance.
- Compact size to prevent tip damage.
- Removable pre-orifice.
- Ideal for use with automatic sprayer controllers.

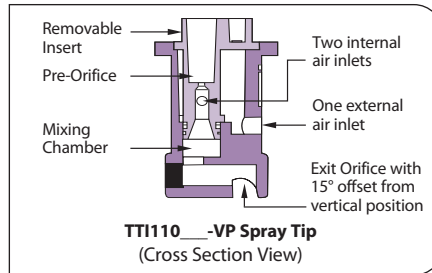

Note: Due to pre-orifice design, this tip is not compatible with the 4193A check valve tip strainer.



- Wide operating pressure range: 15–100 PSI (1–7 bar).
- Automatic alignment when used with 25598-*-NYR Quick TeeJet® cap and gasket. See page 64 for additional information.



TIPO	PSI	DROP SIZE	CAPACITY ONE NOZZLE IN GPM	CAPACITY ONE NOZZLE IN OZ./MIN.	20°															
					GPA								GALLONS PER 1000 SQ. FT.							
					4 MPH	5 MPH	6 MPH	8 MPH	10 MPH	12 MPH	15 MPH	20 MPH	2 MPH	3 MPH	4 MPH	5 MPH				
TTI110015 (100)	15 UC	0.092	12	6.8	5.5	4.6	3.4	2.7	2.3	1.8	1.4	0.31	0.21	0.16	0.13					
	20 UC	0.11	14	8.2	6.5	5.4	4.1	3.3	2.7	2.2	1.6	0.37	0.25	0.19	0.15					
	30 UC	0.13	17	9.7	7.7	6.4	4.8	3.9	3.2	2.6	1.9	0.44	0.29	0.22	0.18					
	40 UC	0.15	19	11.1	8.9	7.4	5.6	4.5	3.7	3.0	2.2	0.51	0.34	0.26	0.20					
	50 UC	0.17	22	12.6	10.1	8.4	6.3	5.0	4.2	3.4	2.5	0.58	0.39	0.29	0.23					
	60 UC	0.18	23	13.4	10.7	8.9	6.7	5.3	4.5	3.6	2.7	0.61	0.41	0.31	0.24					
TTI11002 (50)	20 UC	0.14	18	10.4	8.3	6.9	5.2	4.2	3.5	2.8	2.1	0.48	0.32	0.24	0.19					
	30 UC	0.17	22	12.6	10.1	8.4	6.3	5.0	4.2	3.4	2.5	0.58	0.39	0.29	0.23					
	40 UC	0.20	26	14.9	11.9	9.9	7.4	5.9	5.0	4.0	3.0	0.68	0.45	0.34	0.27					
	50 UC	0.22	28	16.3	13.1	10.9	8.2	6.5	5.4	4.4	3.3	0.75	0.50	0.37	0.30					
	60 UC	0.24	31	17.8	14.3	11.9	8.9	7.1	5.9	4.8	3.6	0.82	0.54	0.41	0.33					
	70 UC	0.26	33	19.3	15.4	12.9	9.7	7.7	6.4	5.1	3.9	0.88	0.59	0.44	0.35					
TTI110025 (50)	20 UC	0.15	19	11.1	8.9	7.4	5.6	4.5	3.7	3.0	2.2	0.51	0.34	0.26	0.20					
	30 UC	0.18	23	13.4	10.7	8.9	6.7	5.3	4.5	3.6	2.7	0.61	0.41	0.31	0.24					
	40 UC	0.22	28	16.3	13.1	10.9	8.2	6.5	5.4	4.4	3.3	0.75	0.50	0.37	0.30					
	50 UC	0.25	32	18.6	14.9	12.4	9.3	7.4	6.2	5.0	3.7	0.85	0.57	0.43	0.34					
	60 UC	0.28	36	21	16.6	13.9	10.4	8.3	6.9	5.5	4.2	0.95	0.63	0.48	0.38					
	70 UC	0.31	40	23	18.4	15.3	11.5	9.2	7.7	6.1	4.6	1.1	0.70	0.53	0.42					
TTI11003 (50)	20 UC	0.18	23	13.4	10.7	8.9	6.7	5.3	4.5	3.6	2.7	0.61	0.41	0.31	0.24					
	30 UC	0.21	27	15.6	12.5	10.4	7.8	6.2	5.2	4.2	3.1	0.71	0.48	0.36	0.29					
	40 UC	0.26	33	19.3	15.4	12.9	9.7	7.7	6.4	5.1	3.9	0.88	0.59	0.44	0.35					
	50 UC	0.34	44	25	20	16.8	12.6	10.1	8.4	6.7	5.0	1.2	0.77	0.58	0.46					
	60 UC	0.37	47	27	22	18.3	13.7	11.0	9.2	7.3	5.5	1.3	0.84	0.63	0.50					
	70 UC	0.40	51	30	24	19.8	14.9	11.9	9.9	7.9	5.9	1.4	0.91	0.68	0.54					
TTI11004 (50)	20 UC	0.21	27	15.6	12.5	10.4	7.8	6.2	5.2	4.2	3.1	0.71	0.48	0.36	0.29					
	30 UC	0.26	33	19.3	15.4	12.9	9.7	7.7	6.4	5.1	3.9	0.88	0.59	0.44	0.35					
	40 UC	0.30	38	22	17.8	14.9	11.1	8.9	7.4	5.9	4.5	1.0	0.68	0.51	0.41					
	50 UC	0.34	44	25	20	16.8	12.6	10.1	8.4	6.7	5.0	1.2	0.77	0.58	0.46					
	60 UC	0.37	47	27	22	18.3	13.7	11.0	9.2	7.3	5.5	1.3	0.84	0.63	0.50					
	70 UC	0.40	51	30	24	19.8	14.9	11.9	9.9	7.9	5.9	1.4	0.91	0.68	0.54					
TTI11005 (50)	20 UC	0.22	28	16.3	13.1	10.9	8.2	6.5	5.4	4.4	3.3	0.75	0.50	0.37	0.30					
	30 UC	0.25	32	18.6	14.9	12.4	9.3	7.4	6.2	5.0	3.7	0.85	0.57	0.43	0.34					
	40 UC	0.28	36	21	16.6	13.9	10.4	8.3	6.9	5.5	4.2	0.95	0.63	0.48	0.38					
	50 UC	0.31	40	23	18.4	15.3	11.5	9.2	7.7	6.1	4.6	1.1	0.70	0.53	0.42					
	60 UC	0.33	42	25	19.6	16.3	12.3	9.8	8.2	6.5	4.9	1.1	0.75	0.56	0.45					
	70 UC	0.35	45	26	21	17.3	13.0	10.4	8.7	6.9	5.2	1.2	0.79	0.60	0.48					
TTI11006 (50)	20 UC	0.18	23	13.4	10.7	8.9	6.7	5.3	4.5	3.6	2.7	0.61	0.41	0.31	0.24					
	30 UC	0.21	27	15.6	12.5	10.4	7.8	6.2	5.2	4.2	3.1	0.71	0.48	0.36	0.29					
	40 UC	0.26	33	19.3	15.4	12.9	9.7	7.7	6.4	5.1	3.9	0.88	0.59	0.44	0.35					
	50 UC	0.34	44	25	20	16.8	12.6	10.1	8.4	6.7	5.0	1.2	0.77	0.58	0.46					
	60 UC	0.37	47	27	22	18.3	13.7	11.0	9.2	7.3	5.5	1.3	0.84	0.63	0.50					
	70 UC	0.40	51	30	24	19.8	14.9	11.9	9.9	7.9	5.9	1.4	0.91	0.68	0.54					

CONTACT PRODUCT	SYSTEMIC PRODUCT	DRIFT MANAGEMENT
—	EXCELLENT	EXCELLENT

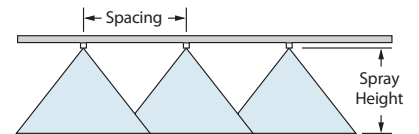

Optimum Spray Height

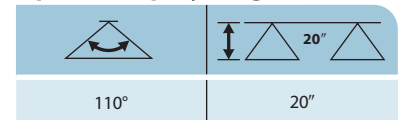

How to order:

Specify tip number.

Example:

TTI11004-VP – Polymer with VisiFlo® color-coding

TTI11003-VP-C – Polymer with VisiFlo color-coding, includes Quick TeeJet cap and gasket

Note: Always double check your application rates. Tabulations are based on spraying water at 70°F (21°C). See pages 136–157 for drop size classification, useful formulas and other information.



XR TeeJet® Extended Range Flat Spray Tips

Typical Applications:

See selection guide on page 4 for recommended typical applications for XR TeeJet tips.

Features:

- Excellent spray distribution over a wide range of pressures — 15–60 PSI (1–4 bar).
- Ideal for rigs equipped with sprayer controllers.
- Reduces drift at lower pressures, better coverage at higher pressures.
- Available in stainless steel, ceramic and polymer in 80° and 110° spray angles with VisiFlo® color-coding.

- Ceramic is available with corrosive-resistant polypropylene VisiFlo color-coded tip holder in 80° capacities 03–08 and 110° capacities 02–08.
- XR110025 only available in VK.
- XR80025 and XR80035 only available in VS.
- Brass available in 110° only.
- Automatic spray alignment with 25612-*NYR Quick TeeJet® cap and gasket. Reference page 64 for more information.
- Automatic spray alignment for sizes 10 and 15 with 25610-*NYR Quick TeeJet cap and gasket. Reference page 64 for more information.

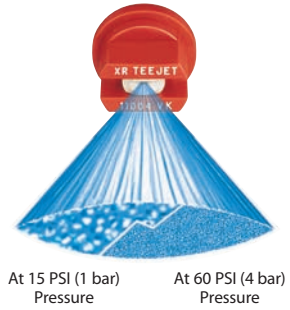

Tip No.	PSI	DROPS PER MIN.	CAPACITY ONE NOZZLE IN GPM	CAPACITY ONE NOZZLE IN OZ./MIN.	20°															
					GPA															
					4 MPH				5 MPH				6 MPH				8 MPH			
XR8001 XR11001 (100)	15	F	F	0.061	7.8	4.5	3.6	3.0	2.3	1.8	1.5	1.2	0.91	0.21	0.14	0.10	0.08			
	20	F	F	0.071	9.1	5.3	4.2	3.5	2.6	2.1	1.8	1.4	1.1	0.24	0.16	0.12	0.10			
	30	F	F	0.087	11	6.5	5.2	4.3	3.2	2.6	2.2	1.7	1.3	0.30	0.20	0.15	0.12			
	40	F	F	0.10	13	7.4	5.9	5.0	3.7	3.0	2.5	2.0	1.5	0.34	0.23	0.17	0.14			
	50	F	F	0.11	14	8.2	6.5	5.4	4.1	3.3	2.7	2.2	1.6	0.37	0.25	0.19	0.15			
XR80015 XR110015 (100)	15	M	F	0.092	12	6.8	5.5	4.6	3.4	2.7	2.3	1.8	1.4	0.31	0.21	0.16	0.13			
	20	F	F	0.11	14	8.2	6.5	5.4	4.1	3.3	2.7	2.2	1.6	0.37	0.25	0.19	0.15			
	30	F	F	0.13	17	9.7	7.7	6.4	4.8	3.9	3.2	2.6	1.9	0.44	0.29	0.22	0.18			
	40	F	F	0.15	19	11.1	8.9	7.4	5.6	4.5	3.7	3.0	2.2	0.51	0.34	0.26	0.20			
	50	F	F	0.17	22	12.6	10.1	8.4	6.3	5.0	4.2	3.4	2.5	0.58	0.39	0.29	0.23			
XR8002 XR11002 (50)	15	M	M	0.12	15	8.9	7.1	5.9	4.5	3.6	3.0	2.4	1.8	0.41	0.27	0.20	0.16			
	20	F	F	0.14	18	10.4	8.3	6.9	5.2	4.2	3.5	2.8	2.1	0.48	0.32	0.24	0.19			
	30	F	F	0.17	22	12.6	10.1	8.4	6.3	5.0	4.2	3.4	2.5	0.58	0.39	0.29	0.23			
	40	F	F	0.20	26	14.9	11.9	9.9	7.4	5.9	5.0	4.0	3.0	0.68	0.45	0.34	0.27			
	50	F	F	0.22	28	16.3	13.1	10.9	8.2	6.5	5.4	4.4	3.3	0.75	0.50	0.37	0.30			
XR80025 XR110025 (50)	15	M	M	0.15	19	11.1	8.9	7.4	5.6	4.5	3.7	3.0	2.2	0.51	0.34	0.26	0.20			
	20	M	M	0.18	23	13.4	10.7	8.9	6.7	5.3	4.5	3.6	2.7	0.61	0.41	0.31	0.24			
	30	F	F	0.22	28	16.3	13.1	10.9	8.2	6.5	5.4	4.4	3.3	0.75	0.50	0.37	0.30			
	40	F	F	0.25	32	18.6	14.9	12.4	9.3	7.4	6.2	5.0	3.7	0.85	0.57	0.43	0.34			
	50	F	F	0.28	36	21	16.6	13.9	10.4	8.3	6.9	5.5	4.2	0.95	0.63	0.48	0.38			
XR8003 XR11003 (50)	15	M	M	0.18	23	13.4	10.7	8.9	6.7	5.3	4.5	3.6	2.7	0.61	0.41	0.31	0.24			
	20	M	M	0.21	27	15.6	12.5	10.4	7.8	6.2	5.2	4.2	3.1	0.71	0.48	0.36	0.29			
	30	F	F	0.26	33	19.3	15.4	12.9	9.7	7.7	6.4	5.1	3.9	0.88	0.59	0.44	0.35			
	40	F	F	0.30	38	22	17.8	14.9	11.1	8.9	7.4	5.9	4.5	1.0	0.68	0.51	0.41			
	50	F	F	0.34	44	25	20	16.8	12.6	10.1	8.4	6.7	5.0	1.2	0.77	0.58	0.46			
XR80035 (50)	15	M	M	0.21	27	15.6	12.5	10.4	7.8	6.2	5.2	4.2	3.1	0.71	0.48	0.36	0.29			
	20	M	M	0.25	32	18.6	14.9	12.4	9.3	7.4	6.2	5.0	3.7	0.85	0.57	0.43	0.34			
	30	M	M	0.30	38	22	17.8	14.9	11.1	8.9	7.4	5.9	4.5	1.0	0.68	0.51	0.41			
	40	M	M	0.35	45	26	21	17.3	13.0	10.4	8.7	6.9	5.2	1.2	0.79	0.60	0.48			
	50	F	F	0.39	50	29	23	19.3	14.5	11.6	9.7	7.7	5.8	1.3	0.88	0.66	0.53			
XR8004 XR11004 (50)	15	C	M	0.24	31	17.8	14.3	11.9	8.9	7.1	5.9	4.8	3.6	0.82	0.54	0.41	0.33			
	20	M	M	0.28	36	21	16.6	13.9	10.4	8.3	6.9	5.5	4.2	1.0	0.63	0.48	0.38			
	30	M	M	0.35	45	26	21	17.3	13.0	10.4	8.7	6.9	5.2	1.2	0.79	0.60	0.48			
	40	M	M	0.40	51	30	24	19.8	14.9	11.9	9.9	7.9	5.9	1.4	0.91	0.68	0.54			
	50	F	F	0.45	58	33	27	22	16.7	13.4	11.1	8.9	6.7	1.5	1.0	0.77	0.61			
XR8005 XR11005 (50)	15	C	M	0.31	40	23	18.4	15.3	11.5	9.2	7.7	6.1	4.6	1.1	0.70	0.53	0.42			
	20	C	M	0.35	45	26	21	17.3	13.0	10.4	8.7	6.9	5.2	1.2	0.79	0.60	0.48			
	30	M	M	0.43	55	32	26	21	16.0	12.8	10.6	8.5	6.4	1.5	0.97	0.73	0.58			
	40	M	M	0.50	64	37	30	25	18.6	14.9	12.4	9.9	7.4	1.7	1.1	0.85	0.68			
	50	M	F	0.56	72	42	33	28	21	16.6	13.9	11.1	8.3	1.9	1.3	0.95	0.76			
XR8006 XR11006 (50)	15	C	C	0.37	47	27	22	18.3	13.7	11.0	9.2	7.3	5.5	1.3	0.84	0.63	0.50			
	20	C	M	0.42	54	31	25	21	15.6	12.5	10.4	8.3	6.2	1.4	1.0	0.71	0.57			
	30	M	M	0.52	67	39	31	26	19.3	15.4	12.9	10.3	7.7	1.8	1.2	0.88	0.71			
	40	M	M	0.60	77	45	36	30	22	17.8	14.9	11.9	8.9	2.0	1.4	1.0	0.82			
	50	M	F	0.67	86	50	40	33	25	19.9	16.6	13.3	9.9	2.3	1.5	1.1	0.91			
XR8008 XR11008 (50)	15	VC	C	0.49	63	36	29	24	18.2	14.6	12.1	9.7	7.3	1.7	1.1	0.83	0.67			
	20	VC	C	0.57	73	42	34	28	21	16.9	14.1	11.3	8.5	1.9	1.3	0.97	0.78			
	30	C	C	0.69	88	51	41	34	26	20	17.1	13.7	10.2	2.3	1.6	1.2	0.94			
	40	M	M	0.80	102	59	48	40	30	24	19.8	15.8	11.9	2.7	1.8	1.4	1.1			
	50	M	M	0.89	114	66	53	44	33	26	22	17.6	13.2	3.0	2.0	1.5	1.2			
XR8010† XR11010†	15	XC	VC	0.61	78	45	36	30	23	18.1	15.1	12.1	9.1	2.1	1.4	1.0	0.83			
	20	XC	VC	0.71	91	53	42	35	26	21	17.6	14.1	10.5	2.4	1.6	1.2	0.97			
	30	C	C	0.87	111	65	52	43	32	26	22	17.2	12.9	3.0	2.0	1.5	1.2			
	40	C	M	1.00	128	74	59	50	37	30	25	19.8	14.9	3.4	2.3	1.7	1.4			
	50	C	M	1.12	143	83	67	55	42	33	28	22	16.6	3.8	2.5	1.9	1.5			
XR8015† XR11015†	15	XC	VC	0.92	118	68	55	46	34	27	23	18.2	13.7	3.1	2.1	1.6	1.3			
	20	XC	VC	1.06	136	79	63	52	39	31	26	21	15.7	3.6	2.4	1.8	1.4			
	30	VC	VC	1.30	166	97	77	64	48	39	32	26	19.3	4.4	2.9	2.2	1.8			
	40	VC	VC	1.50	192	111	89	74	56	45	37	30	22	5.1	3.4	2.6	2.0			
	50	C	C	1.68	215	125	100	83	62	50	42	33	25	5.7	3.8	2.9	2.3			
60	C	C	1.84	236	137	109	91	68	55	46	36	27	6.3	4.2	3.1	2.5				

Note: Always double check your application rates. Tabulations are based on spraying water at 70°F (21°C). See pages 136–157 for drop size classification, useful formulas and other information. †Available in all stainless steel only.

CONTACT PRODUCT	SYSTEMIC PRODUCT	DRIFT MANAGEMENT
EXCELLENT	GOOD	GOOD
GOOD*	VERY GOOD*	VERY GOOD*

*At pressures below 30 PSI (2.0 bar)

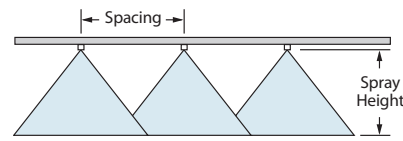

Optimum Spray Height

Tip Angle	Optimum Spray Height
80°	30"
110°	20"

How to order:

Specify tip number.

Examples:

- XR8004VS – Stainless Steel with VisiFlo color-coding
- XR11004-VP – Polymer with VisiFlo color-coding (110° only)
- XR11004-VK – Ceramic with polypropylene VisiFlo color-coding
- XR8010SS – Stainless Steel
- XR11004VB – Brass with VisiFlo color-coding (110° only)

XRC TeeJet® Extended Range Flat Spray Tips



Typical Applications:

See selection guide on page 4 for recommended typical applications for XRC TeeJet tips.

Features:

- Excellent spray distribution over a wide range of pressures—15–60 PSI (1–4 bar).
- Ideal for rigs equipped with sprayer controllers.
- Reduces drift at lower pressures, better coverage at higher pressures.

- 80° available in stainless steel (015, 02, 03–06 capacities) and ceramic (02, 03–08 capacities).
- 110° available in stainless steel (025–05 capacities), ceramic (02–08 capacities) and polymer (025–20 capacities).
- XR TeeJet tip molded into Quick TeeJet® cap provides automatic spray alignment.
- Includes tightly fitting washer that stays put and assures a good seal.



At 15 PSI (1 bar) Pressure At 60 PSI (4 bar) Pressure

Icon	PSI	DROP SIZE		CAPACITY ONE NOZZLE IN GPM	CAPACITY ONE NOZZLE IN OZ./MIN.	20°															
		80°	110°			GPA								GALLONS PER 1000 SQ. FT.							
						4 MPH	5 MPH	6 MPH	8 MPH	10 MPH	12 MPH	15 MPH	20 MPH	2 MPH	3 MPH	4 MPH	5 MPH				
XRC80015 (100)	15	M		0.092	12	6.8	5.5	4.6	3.4	2.7	2.3	1.8	1.4	0.31	0.21	0.16	0.13				
	20	F		0.11	14	8.2	6.5	5.4	4.1	3.3	2.7	2.2	1.6	0.37	0.25	0.19	0.15				
	30	F		0.13	17	9.7	7.7	6.4	4.8	3.9	3.2	2.6	1.9	0.44	0.29	0.22	0.18				
	40	F		0.15	19	11.1	8.9	7.4	5.6	4.5	3.7	3.0	2.2	0.51	0.34	0.26	0.20				
	50	F		0.17	22	12.6	10.1	8.4	6.3	5.0	4.2	3.4	2.5	0.58	0.39	0.29	0.23				
XRC8002 XRC11002 (50)	15	M	M	0.12	15	8.9	7.1	5.9	4.5	3.6	3.0	2.4	1.8	0.41	0.27	0.20	0.16				
	20	M	F	0.14	18	10.4	8.3	6.9	5.2	4.2	3.5	2.8	2.1	0.48	0.32	0.24	0.19				
	30	F	F	0.17	22	12.6	10.1	8.4	6.3	5.0	4.2	3.4	2.5	0.58	0.39	0.29	0.23				
	40	F	F	0.20	26	14.9	11.9	9.9	7.4	5.9	5.0	4.0	3.0	0.68	0.45	0.34	0.27				
	50	F	F	0.22	28	16.3	13.1	10.9	8.2	6.5	5.4	4.4	3.3	0.75	0.50	0.37	0.30				
XRC110025 (50)	15	M		0.15	19	11.1	8.9	7.4	5.6	4.5	3.7	3.0	2.2	0.51	0.34	0.26	0.20				
	20	M		0.18	23	13.4	10.7	8.9	6.7	5.3	4.5	3.6	2.7	0.61	0.41	0.31	0.24				
	30	F		0.22	28	16.3	13.1	10.9	8.2	6.5	5.4	4.4	3.3	0.75	0.50	0.37	0.30				
	40	F		0.25	32	18.6	14.9	12.4	9.3	7.4	6.2	5.0	3.7	0.85	0.57	0.43	0.34				
	50	F		0.28	36	21	16.6	13.9	10.4	8.3	6.9	5.5	4.2	0.95	0.63	0.48	0.38				
XRC8003 XRC11003 (50)	15	M	M	0.18	23	13.4	10.7	8.9	6.7	5.3	4.5	3.6	2.7	0.61	0.41	0.31	0.24				
	20	M	M	0.21	27	15.6	12.5	10.4	7.8	6.2	5.2	4.2	3.1	0.71	0.48	0.36	0.29				
	30	F	F	0.26	33	19.3	15.4	12.9	9.7	7.7	6.4	5.1	3.9	0.88	0.59	0.44	0.35				
	40	F	F	0.30	38	22	17.8	14.9	11.1	8.9	7.4	5.9	4.5	1.0	0.68	0.51	0.41				
	50	F	F	0.34	44	25	20	16.8	12.6	10.1	8.4	6.7	5.0	1.2	0.77	0.58	0.46				
XRC8004 XRC11004 (50)	15	C	M	0.24	31	17.8	14.3	11.9	8.9	7.1	5.9	4.8	3.6	0.82	0.54	0.41	0.33				
	20	M	M	0.28	36	21	16.6	13.9	10.4	8.3	6.9	5.5	4.2	0.95	0.63	0.48	0.38				
	30	M	M	0.35	45	26	21	17.3	13.0	10.4	8.7	6.9	5.2	1.2	0.79	0.60	0.48				
	40	M	M	0.40	51	30	24	19.8	14.9	11.9	9.9	7.9	5.9	1.4	0.91	0.68	0.54				
	50	F	F	0.45	58	33	27	22	16.7	13.4	11.1	8.9	6.7	1.5	1.0	0.77	0.61				
XRC8005 XRC11005 (50)	15	C	M	0.31	40	23	18.4	15.3	11.5	9.2	7.7	6.1	4.6	1.1	0.70	0.53	0.42				
	20	C	M	0.35	45	26	21	17.3	13.0	10.4	8.7	6.9	5.2	1.2	0.79	0.60	0.48				
	30	M	M	0.43	55	32	26	21	16.0	12.8	10.6	8.5	6.4	1.5	0.97	0.73	0.58				
	40	M	M	0.50	64	37	30	25	18.6	14.9	12.4	9.9	7.4	1.7	1.1	0.85	0.68				
	50	M	F	0.56	72	42	33	28	21	16.6	13.9	11.1	8.3	1.9	1.3	0.95	0.76				
XRC8006 XRC11006 (50)	15	C	C	0.37	47	27	22	18.3	13.7	11.0	9.2	7.3	5.5	1.3	0.84	0.63	0.50				
	20	C	M	0.42	54	31	25	21	15.6	12.5	10.4	8.3	6.2	1.4	0.95	0.71	0.57				
	30	M	M	0.52	67	39	31	26	19.3	15.4	12.9	10.3	7.7	1.8	1.2	0.88	0.71				
	40	M	M	0.60	77	45	36	30	22	17.8	14.9	11.9	8.9	2.0	1.4	1.0	0.82				
	50	M	M	0.67	86	50	40	33	25	19.9	16.6	13.3	9.9	2.3	1.5	1.1	0.91				
XRC8008 XRC11008 (50)	15	C	C	0.49	63	36	29	24	18.2	14.6	12.1	9.7	7.3	1.7	1.1	0.83	0.67				
	20	C	C	0.57	73	42	34	28	21	16.9	14.1	11.3	8.5	1.9	1.3	0.97	0.78				
	30	C	C	0.69	88	51	41	34	26	20	17.1	13.7	10.2	2.3	1.6	1.2	0.94				
	40	M	M	0.80	102	59	48	40	30	24	19.8	15.8	11.9	2.7	1.8	1.4	1.1				
	50	M	M	0.89	114	66	53	44	33	26	22	17.6	13.2	3.0	2.0	1.5	1.2				
XRC11010	15	VC	C	0.61	78	45	36	30	23	18.1	15.1	12.1	9.1	2.1	1.4	1.0	0.83				
	20	C	C	0.71	91	53	42	35	26	21	17.6	14.1	10.5	2.4	1.6	1.2	0.97				
	30	C	C	0.87	111	65	52	43	32	26	22	17.2	12.9	3.0	2.0	1.5	1.2				
	40	M	M	1.00	128	74	59	50	37	30	25	19.8	14.9	3.4	2.3	1.7	1.4				
	50	M	M	1.12	143	83	67	55	42	33	28	22	16.6	3.8	2.5	1.9	1.5				
XRC11015	15	VC	C	0.92	118	68	55	46	34	27	23	18.2	13.7	3.1	2.1	1.6	1.3				
	20	VC	C	1.06	136	79	63	52	39	31	26	21	15.7	3.6	2.4	1.8	1.4				
	30	VC	C	1.30	166	97	77	64	48	39	32	26	19.3	4.4	2.9	2.2	1.8				
	40	C	C	1.50	192	111	89	74	56	45	37	30	22	5.1	3.4	2.6	2.0				
	50	C	C	1.68	215	125	100	83	62	50	42	33	25	5.7	3.8	2.9	2.3				
XRC11020	15	VC	C	1.84	236	137	109	91	68	55	46	36	27	6.3	4.2	3.1	2.5				
	20	VC	C	1.22	156	91	72	60	45	36	30	24	18.1	4.1	2.8	2.1	1.7				
	30	VC	C	1.41	180	105	84	70	52	42	35	28	21	4.8	3.2	2.4	1.9				
	40	VC	C	1.73	221	128	103	86	64	51	43	34	26	5.9	3.9	2.9	2.4				
	50	VC	C	2.00	256	149	119	99	74	59	50	40	30	6.8	4.5	3.4	2.7				
60	VC	C	2.24	287	166	133	111	83	67	55	44	33	7.6	5.1	3.8	3.0					
60	VC	C	2.45	314	182	146	121	91	73	61	49	36	8.3	5.6	4.2	3.3					



CONTACT PRODUCT	SYSTEMIC PRODUCT	DRIFT MANAGEMENT
EXCELLENT	GOOD	GOOD
GOOD*	VERY GOOD*	VERY GOOD*

*At pressures below 30 PSI (2.0 bar)

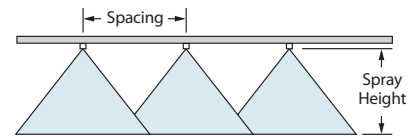

Optimum Spray Height

Tip Angle	Optimum Spray Height
80°	30"
110°	20"

How to order:

Specify tip number.

Examples:

- XRC11004-VS – Stainless Steel with VisiFlo® color-coding
- XRC11004-VP – Polymer with VisiFlo color-coding
- XRC11004-VK – Ceramic with VisiFlo color-coding

Note: Always double check your application rates. Tabulations are based on spraying water at 70°F (21°C). See pages 136–157 for drop size classification, useful formulas and other information.



TeeJet® VisiFlo® Flat Spray Tips

Features:

- Tapered edge flat spray pattern for uniform coverage in broadcast spraying.
- VisiFlo color-coded version available in stainless steel, ceramic and polymer in 80° or 110° spray angles in selected sizes.
- Available in ceramic 80° capacities 01–02 and 110° capacities 01–015. See XR and XRC TeeJet® tips on page 12–13 for larger capacities.

- Standard version (not color-coded) available in 15°, 25°, 40°, 50° and 65° spray angles in brass, stainless steel or hardened stainless steel.
- See page 35 for TeeJet even flat spray tips.
- Automatic spray alignment with 25612*-NYR Quick TeeJet® cap and gasket. Reference page 57 for more information.
- Automatic spray alignment for sizes 10 through 20 with 25610*-NYR Quick TeeJet cap and gasket. Reference page 64 for more information.



TIPO	PSI	DROP SIZE		CAPACITY ONE NOZZLE IN GPM	CAPACITY ONE NOZZLE IN OZ./MIN.	20°														
		80°	110°			GPA										GALLONS PER 1000 SQ. FT.				
						4 MPH	5 MPH	6 MPH	8 MPH	10 MPH	12 MPH	15 MPH	20 MPH	2 MPH	3 MPH	4 MPH	5 MPH			
TP650050†	30			0.043	5.5	3.2	2.6	2.1	1.6	1.3	1.1	0.85	0.64	0.15	0.10	0.07	0.06			
TP800050†	35			0.047	6.0	3.5	2.8	2.3	1.7	1.4	1.2	0.93	0.70	0.16	0.11	0.08	0.06			
TP110050†	40			0.050	6.4	3.7	3.0	2.5	1.9	1.5	1.2	0.99	0.74	0.17	0.11	0.09	0.07			
TP110050†	50			0.056	7.2	4.2	3.3	2.8	2.1	1.7	1.4	1.1	0.83	0.19	0.13	0.10	0.08			
TP110050†	60			0.061	7.8	4.5	3.6	3.0	2.3	1.8	1.5	1.2	0.91	0.21	0.14	0.10	0.08			
TP650067†	30			0.058	7.4	4.3	3.4	2.9	2.2	1.7	1.4	1.1	0.86	0.20	0.13	0.10	0.08			
TP800067†	35			0.063	8.1	4.7	3.7	3.1	2.3	1.9	1.6	1.2	0.94	0.21	0.14	0.11	0.09			
TP110067†	40			0.067	8.6	5.0	4.0	3.3	2.5	2.0	1.7	1.3	0.99	0.23	0.15	0.11	0.09			
TP110067†	50			0.075	9.6	5.6	4.5	3.7	2.8	2.2	1.9	1.5	1.1	0.26	0.17	0.13	0.10			
TP110067†	60			0.082	10	6.1	4.9	4.1	3.0	2.4	2.0	1.6	1.2	0.28	0.19	0.14	0.11			
TP6501†	30	F	F	0.087	11	6.5	5.2	4.3	3.2	2.6	2.2	1.7	1.3	0.30	0.20	0.15	0.12			
TP8001	35	F	F	0.094	12	7.0	5.6	4.7	3.5	2.8	2.3	1.9	1.4	0.32	0.21	0.16	0.13			
TP11001	40	F	F	0.10	13	7.4	5.9	5.0	3.7	3.0	2.5	2.0	1.5	0.34	0.23	0.17	0.14			
TP11001	50	F	F	0.11	14	8.2	6.5	5.4	4.1	3.3	2.7	2.2	1.6	0.37	0.25	0.19	0.15			
TP11001	60	F	VF	0.12	15	8.9	7.1	5.9	4.5	3.6	3.0	2.4	1.8	0.41	0.27	0.20	0.16			
TP65015†	30	F	F	0.13	17	9.7	7.7	6.4	4.8	3.9	3.2	2.6	1.9	0.44	0.29	0.22	0.18			
TP80015	35	F	F	0.14	18	10.4	8.3	6.9	5.2	4.2	3.5	2.8	2.1	0.48	0.32	0.24	0.19			
TP110015	40	F	F	0.15	19	11.1	8.9	7.4	5.6	4.5	3.7	3.0	2.2	0.51	0.34	0.26	0.20			
TP110015	50	F	F	0.17	22	12.6	10.1	8.4	6.3	5.0	4.2	3.4	2.5	0.58	0.39	0.29	0.23			
TP110015	60	F	F	0.18	23	13.4	10.7	8.9	6.7	5.3	4.5	3.6	2.7	0.61	0.41	0.31	0.24			
TP6502†	30	F	F	0.17	22	12.6	10.1	8.4	6.3	5.0	4.2	3.4	2.5	0.58	0.39	0.29	0.23			
TP8002	35	F	F	0.19	24	14.1	11.3	9.4	7.1	5.6	4.7	3.8	2.8	0.65	0.43	0.32	0.26			
TP11002	40	F	F	0.20	26	14.9	11.9	9.9	7.4	5.9	5.0	4.0	3.0	0.68	0.45	0.34	0.27			
TP11002	50	F	F	0.22	28	16.3	13.1	10.9	8.2	6.5	5.4	4.4	3.3	0.75	0.50	0.37	0.30			
TP11002	60	F	F	0.24	31	17.8	14.3	11.9	8.9	7.1	5.9	4.8	3.6	0.82	0.54	0.41	0.33			
TP6503†	30	F	F	0.26	33	19.3	15.4	12.9	9.7	7.7	6.4	5.1	3.9	0.88	0.59	0.44	0.35			
TP8003	35	F	F	0.28	36	21	16.6	13.9	10.4	8.3	6.9	5.5	4.2	0.95	0.63	0.48	0.38			
TP11003	40	F	F	0.30	38	22	17.8	14.9	11.1	8.9	7.4	5.9	4.5	1.0	0.68	0.51	0.41			
TP11003	50	F	F	0.34	44	25	20	16.8	12.6	10.1	8.4	6.7	5.0	1.2	0.77	0.58	0.46			
TP11003	60	F	F	0.37	47	27	22	18.3	13.7	11.0	9.2	7.3	5.5	1.3	0.84	0.63	0.50			
TP6504†	30	M	M	0.35	45	26	21	17.3	13.0	10.4	8.7	6.9	5.2	1.2	0.79	0.60	0.48			
TP8004	35	M	M	0.37	47	27	22	18.3	13.7	11.0	9.2	7.3	5.5	1.3	0.84	0.63	0.50			
TP11004	40	M	M	0.40	51	30	24	19.8	14.9	11.9	9.9	7.9	5.9	1.4	0.91	0.68	0.54			
TP11004	50	F	F	0.45	58	33	27	22	16.7	13.4	11.1	8.9	6.7	1.5	1.0	0.77	0.61			
TP11004	60	F	F	0.49	63	36	29	24	18.2	14.6	12.1	9.7	7.3	1.7	1.1	0.83	0.67			
TP6505†	30	M	M	0.43	55	32	26	21	16.0	12.8	10.6	8.5	6.4	1.5	0.97	0.73	0.58			
TP8005	35	M	M	0.47	60	35	28	23	17.4	14.0	11.6	9.3	7.0	1.6	1.1	0.80	0.64			
TP11005	40	M	M	0.50	64	37	30	25	18.6	14.9	12.4	9.9	7.4	1.7	1.1	0.85	0.68			
TP11005	50	M	F	0.56	72	42	33	28	21	16.6	13.9	11.1	8.3	1.9	1.3	0.95	0.76			
TP11005	60	F	F	0.61	78	45	36	30	23	18.1	15.1	12.1	9.1	2.1	1.4	1.0	0.83			
TP6506†	30	M	M	0.52	67	39	31	26	19.3	15.4	12.9	10.3	7.7	1.8	1.2	0.88	0.71			
TP8006	35	M	M	0.56	72	42	33	28	21	16.6	13.9	11.1	8.3	1.9	1.3	0.95	0.76			
TP11006	40	M	M	0.60	77	45	36	30	22	17.8	14.9	11.9	8.9	2.0	1.4	1.0	0.82			
TP11006	50	M	M	0.67	86	50	40	33	25	19.9	16.6	13.3	9.9	2.3	1.5	1.1	0.91			
TP11006	60	M	F	0.73	93	54	43	36	27	22	18.1	14.5	10.8	2.5	1.7	1.2	0.99			
TP6508†	30	C	C	0.69	88	51	41	34	26	20	17.1	13.7	10.2	2.3	1.6	1.2	0.94			
TP8008	35	C	M	0.75	96	56	45	37	28	22	18.6	14.9	11.1	2.6	1.7	1.3	1.0			
TP11008	40	M	M	0.80	102	59	48	40	30	24	19.8	15.8	11.9	2.7	1.8	1.4	1.1			
TP11008	50	M	M	0.89	114	66	53	44	33	26	22	17.6	13.2	3.0	2.0	1.5	1.2			
TP11008	60	M	M	0.98	125	73	58	49	36	29	24	19.4	14.6	3.3	2.2	1.7	1.3			
TP6510†	30	C	C	0.87	111	65	52	43	32	26	22	17.2	12.9	3.0	2.0	1.5	1.2			
TP8010†	35	C	C	0.94	120	70	56	47	35	28	23	18.6	14.0	3.2	2.1	1.6	1.3			
TP11010†	40	C	M	1.00	128	74	59	50	37	30	25	19.8	14.9	3.4	2.3	1.7	1.4			
TP11010†	50	C	M	1.12	143	83	67	55	42	33	28	22	16.6	3.8	2.5	1.9	1.5			
TP11010†	60	C	M	1.22	156	91	72	60	45	36	30	24	18.1	4.1	2.8	2.1	1.7			
TP6515†	30	VC	VC	1.30	166	97	77	64	48	39	32	26	19.3	4.4	2.9	2.2	1.8			
TP8015†	35	VC	C	1.40	179	104	83	69	52	42	35	28	21	4.8	3.2	2.4	1.9			
TP11015†	40	VC	C	1.50	192	111	89	74	56	45	37	30	22	5.1	3.4	2.6	2.0			
TP11015†	50	C	C	1.68	215	125	100	83	62	50	42	33	25	5.7	3.8	2.9	2.3			
TP11015†	60	C	C	1.84	236	137	109	91	68	55	46	36	27	6.3	4.2	3.1	2.5			
TP6520†	30			1.73	221	128	103	86	64	51	43	34	26	5.9	3.9	2.9	2.4			
TP8020†	35			1.87	239	139	111	93	69	56	46	37	28	6.4	4.2	3.2	2.5			
TP11020†	40			2.00	256	149	119	99	74	59	50	40	30	6.8	4.5	3.4	2.7			
TP11020†	50			2.24	287	166	133	111	83	67	55	44	33	7.6	5.1	3.8	3.0			
TP11020†	60			2.45	314	182	146	121	91	73	61	49	36	8.3	5.6	4.2	3.3			

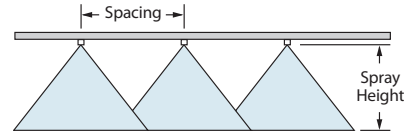

Optimum Spray Height	
65°	35"
80°	30"
110°	20"

- How to order:**
Specify tip number.
- Examples:
- TP8002VS – Stainless Steel with VisiFlo color-coding
 - TP11002VP – Polymer with VisiFlo color-coding
 - TP11002-HSS – Hardened Stainless Steel
 - TP8002-SS – Stainless Steel
 - TP8002 – Brass

Note: Always double check your application rates. Tabulations are based on spraying water at 70°F (21°C). See pages 136–157 for drop size classification, useful formulas and other information.

† Available in brass and/or stainless steel and/or hardened stainless steel.

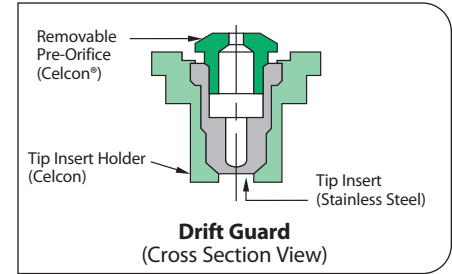

Note: Due to the pre-orifice design, this tip is not compatible with the 4193A check valve tip strainer.

Features:

- Pre-orifice design produces larger droplets and reduces the small drift-prone droplets, minimizing off-target spray contamination.
- Tapered edge flat spray pattern provides uniform coverage when adjacent nozzle patterns are overlapped in broadcast spraying.
- The color-coded pre-orifice is removable for any necessary cleaning operations.
- Available in both 80° and 110° spray angles with a durable stainless steel orifice.
- Automatic spray alignment with 25612-*-NYR Quick TeeJet® cap and gasket. Reference page 64 for more information.



Icon	PSI	DROP SIZE		CAPACITY ONE NOZZLE IN GPM	CAPACITY ONE NOZZLE IN OZ./MIN.	20°										GALLONS PER 1000 SQ. FT.				
		80°	110°			GPA														
		4 MPH	5 MPH			6 MPH	8 MPH	10 MPH	12 MPH	15 MPH	20 MPH	2 MPH	3 MPH	4 MPH	5 MPH					
DG80015† DG110015 (100)	30	M	M	0.13	17	9.7	7.7	6.4	4.8	3.9	3.2	2.6	1.9	0.44	0.29	0.22	0.18			
	35	M	M	0.14	18	10.4	8.3	6.9	5.2	4.2	3.5	2.8	2.1	0.48	0.32	0.24	0.19			
	40	M	F	0.15	19	11.1	8.9	7.4	5.6	4.5	3.7	3.0	2.2	0.51	0.34	0.26	0.20			
	50	M	F	0.17	22	12.6	10.1	8.4	6.3	5.0	4.2	3.4	2.5	0.58	0.39	0.29	0.23			
60	F	F	0.18	23	13.4	10.7	8.9	6.7	5.3	4.5	3.6	2.7	0.61	0.41	0.31	0.24				
DG8002† DG11002 (50)	30	M	M	0.17	22	12.6	10.1	8.4	6.3	5.0	4.2	3.4	2.5	0.58	0.39	0.29	0.23			
	35	M	M	0.19	24	14.1	11.3	9.4	7.1	5.6	4.7	3.8	2.8	0.65	0.43	0.32	0.26			
	40	M	M	0.20	26	14.9	11.9	9.9	7.4	5.9	5.0	4.0	3.0	0.68	0.45	0.34	0.27			
	50	M	M	0.22	28	16.3	13.1	10.9	8.2	6.5	5.4	4.4	3.3	0.75	0.50	0.37	0.30			
60	M	M	0.24	31	17.8	14.3	11.9	8.9	7.1	5.9	4.8	3.6	0.82	0.54	0.41	0.33				
DG8003† DG11003 (50)	30	C	C	0.26	33	19.3	15.4	12.9	9.7	7.7	6.4	5.1	3.9	0.88	0.59	0.44	0.35			
	35	M	M	0.28	36	21	16.6	13.9	10.4	8.3	6.9	5.5	4.2	0.95	0.63	0.48	0.38			
	40	M	M	0.30	38	22	17.8	14.9	11.1	8.9	7.4	5.9	4.5	1.0	0.68	0.51	0.41			
	50	M	M	0.34	44	25	20	16.8	12.6	10.1	8.4	6.7	5.0	1.2	0.77	0.58	0.46			
60	M	M	0.37	47	27	22	18.3	13.7	11.0	9.2	7.3	5.5	1.3	0.84	0.63	0.50				
DG8004† DG11004 (50)	30	C	C	0.35	45	26	21	17.3	13.0	10.4	8.7	6.9	5.2	1.2	0.79	0.60	0.48			
	35	C	C	0.37	47	27	22	18.3	13.7	11.0	9.2	7.3	5.5	1.3	0.84	0.63	0.50			
	40	C	M	0.40	51	30	24	19.8	14.9	11.9	9.9	7.9	5.9	1.4	0.91	0.68	0.54			
	50	M	M	0.45	58	33	27	22	16.7	13.4	11.1	8.9	6.7	1.5	1.0	0.77	0.61			
60	M	M	0.49	63	36	29	24	18.2	14.6	12.1	9.7	7.3	1.7	1.1	0.83	0.67				
DG8005† DG11005 (50)	30	C	C	0.43	55	32	26	21	16.0	12.8	10.6	8.5	6.4	1.5	0.97	0.73	0.58			
	35	C	C	0.47	60	35	28	23	17.4	14.0	11.6	9.3	7.0	1.6	1.1	0.80	0.64			
	40	C	C	0.50	64	37	30	25	18.6	14.9	12.4	9.9	7.4	1.7	1.1	0.85	0.68			
	50	M	M	0.56	72	42	33	28	21	16.6	13.9	11.1	8.3	1.9	1.3	0.95	0.76			
60	M	M	0.61	78	45	36	30	23	18.1	15.1	12.1	9.1	2.1	1.4	1.0	0.83				

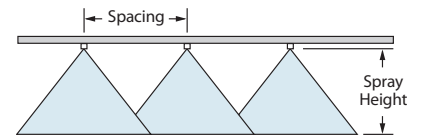

Optimum Spray Height

80°	110°
30"	20"

How to order:

Specify tip number.

Examples:

- DG8002VS – Stainless Steel with VisiFlo® color-coding
- DG11002-VP – Polymer with VisiFlo color-coding

Note: Always double check your application rates. Tabulations are based on spraying water at 70°F (21°C). See pages 136–157 for drop size classification, useful formulas and other information.

† Available in VisiFlo stainless steel only.



Turbo TwinJet® Twin Flat Spray Tips

Typical Applications:

See selection guide on page 4 for recommended typical applications for Turbo TwinJet tips.

Features:

- Dual outlet design produces two 110° flat fan spray patterns using the patented technology from the Turbo TeeJet® nozzle. The angle between each spray pattern is 60° forward and back.
- Best suited for broadcast spraying where superior leaf coverage and canopy penetration is important.
- Droplet size range is slightly larger than for the same capacity Turbo TeeJet nozzle providing drift-reducing properties with increased canopy coverage and penetration.
- Molded polymer for excellent chemical and wear resistance.
- Available in six VisiFlo® color-coded capacities with pressure ranges from 20–90 PSI (1.5–6 bar).
- Ideal for use with automatic sprayer controllers.
- Automatic alignment when used with 25612*-NYR Quick TeeJet® cap and gasket. See page 64 for additional information.

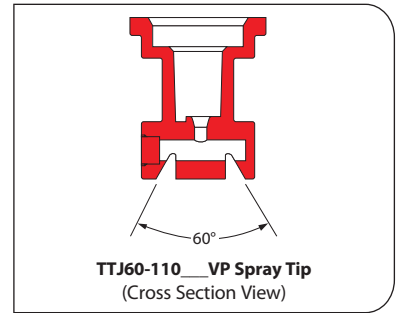
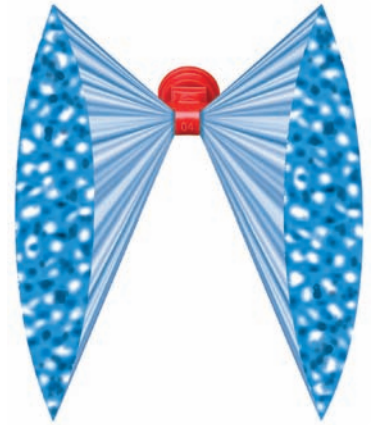

TI	PSI	DROPSIZE	CAPACITY ONE NOZZLE IN GPM	CAPACITY ONE NOZZLE IN OZ./MIN.	20°										GALLONS PER 1000 SQ. FT.				
					GPA														
					4 MPH	5 MPH	6 MPH	8 MPH	10 MPH	12 MPH	15 MPH	20 MPH	2 MPH	3 MPH	4 MPH	5 MPH			
TTJ60-11002 (100)	20	C	0.14	18	10.4	8.3	6.9	5.2	4.2	3.5	2.8	2.1	0.48	0.32	0.24	0.19			
	30	C	0.17	22	12.6	10.1	8.4	6.3	5.0	4.2	3.4	2.5	0.58	0.39	0.29	0.23			
	40	C	0.20	26	14.9	11.9	9.9	7.4	5.9	5.0	4.0	3.0	0.68	0.45	0.34	0.27			
	50	M	0.22	28	16.3	13.1	10.9	8.2	6.5	5.4	4.4	3.3	0.75	0.50	0.37	0.30			
	60	M	0.24	31	17.8	14.3	11.9	8.9	7.1	5.9	4.8	3.6	0.82	0.54	0.41	0.33			
	70	M	0.26	33	19.3	15.4	12.9	9.7	7.7	6.4	5.1	3.9	0.88	0.59	0.44	0.35			
TTJ60-110025 (100)	20	VC	0.18	23	13.4	10.7	8.9	6.7	5.3	4.5	3.6	2.7	0.61	0.41	0.31	0.24			
	30	C	0.22	28	16.3	13.1	10.9	8.2	6.5	5.4	4.4	3.3	0.75	0.50	0.37	0.30			
	40	C	0.25	32	18.6	14.9	12.4	9.3	7.4	6.2	5.0	3.7	0.85	0.57	0.43	0.34			
	50	C	0.28	36	21	16.6	13.9	10.4	8.3	6.9	5.5	4.2	0.95	0.63	0.48	0.38			
	60	C	0.31	40	23	18.4	15.3	11.5	9.2	7.7	6.1	4.6	1.1	0.70	0.53	0.42			
	70	M	0.33	42	25	19.6	16.3	12.3	9.8	8.2	6.5	4.9	1.1	0.75	0.56	0.45			
TTJ60-11003 (100)	20	VC	0.21	27	15.6	12.5	10.4	7.8	6.2	5.2	4.2	3.1	0.71	0.48	0.36	0.29			
	30	C	0.26	33	19.3	15.4	12.9	9.7	7.7	6.4	5.1	3.9	0.88	0.59	0.44	0.35			
	40	C	0.30	38	22	17.8	14.9	11.1	8.9	7.4	5.9	4.5	1.0	0.68	0.51	0.41			
	50	C	0.34	44	25	20	16.8	12.6	10.1	8.4	6.7	5.0	1.2	0.77	0.58	0.46			
	60	C	0.37	47	27	22	18.3	13.7	11.0	9.2	7.3	5.5	1.3	0.84	0.63	0.50			
	70	C	0.40	51	30	24	19.8	14.9	11.9	9.9	7.9	5.9	1.4	0.91	0.68	0.54			
TTJ60-11004 (50)	20	VC	0.28	36	21	16.6	13.9	10.4	8.3	6.9	5.5	4.2	0.95	0.63	0.48	0.38			
	30	C	0.35	45	26	21	17.3	13.0	10.4	8.7	6.9	5.2	1.2	0.79	0.60	0.48			
	40	C	0.40	51	30	24	19.8	14.9	11.9	9.9	7.9	5.9	1.4	0.91	0.68	0.54			
	50	C	0.45	58	33	27	22	16.7	13.4	11.1	8.9	6.7	1.5	1.0	0.77	0.61			
	60	C	0.49	63	36	29	24	18.2	14.6	12.1	9.7	7.3	1.7	1.1	0.83	0.67			
	70	C	0.53	68	39	31	26	19.7	15.7	13.1	10.5	7.9	1.8	1.2	0.90	0.72			
TTJ60-11005 (50)	20	VC	0.35	45	26	21	17.3	13.0	10.4	8.7	6.9	5.2	1.2	0.79	0.60	0.48			
	30	C	0.43	55	32	26	21	16.0	12.8	10.6	8.5	6.4	1.5	0.97	0.73	0.58			
	40	C	0.50	64	37	30	25	18.6	14.9	12.4	9.9	7.4	1.7	1.1	0.85	0.68			
	50	C	0.56	72	42	33	28	21	16.6	13.9	11.1	8.3	1.9	1.3	0.95	0.76			
	60	C	0.61	78	45	36	30	23	18.1	15.1	12.1	9.1	2.1	1.4	1.0	0.83			
	70	C	0.66	84	49	39	33	25	19.6	16.3	13.1	9.8	2.2	1.5	1.1	0.90			
TTJ60-11006 (50)	20	XC	0.42	54	31	25	21	15.6	12.5	10.4	8.3	6.2	1.4	0.95	0.71	0.57			
	30	VC	0.52	67	39	31	26	19.3	15.4	12.9	10.3	7.7	1.8	1.2	0.88	0.71			
	40	C	0.60	77	45	36	30	22	17.8	14.9	11.9	8.9	2.0	1.4	1.0	0.82			
	50	C	0.67	86	50	40	33	25	19.9	16.6	13.3	9.9	2.3	1.5	1.1	0.91			
	60	C	0.73	93	54	43	36	27	22	18.1	14.5	10.8	2.5	1.7	1.2	0.99			
	70	C	0.79	101	59	47	39	29	23	19.6	15.6	11.7	2.7	1.8	1.3	1.1			

Note: Always double check your application rates. Tabulations are based on spraying water at 70°F (21°C). See pages 136–157 for drop size classification, useful formulas and other information.

CONTACT PRODUCT	SYSTEMIC PRODUCT	DRIFT MANAGEMENT
EXCELLENT	EXCELLENT	VERY GOOD
VERY GOOD*	EXCELLENT*	EXCELLENT*

*At pressures below 30 PSI (2.0 bar)

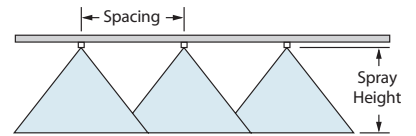

Optimum Spray Height

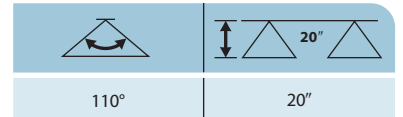

How to order:

Specify tip number.

Example:

TTJ60-11004VP – Polymer with VisiFlo® color-coding

TTJ60-11003VP-C – Polymer with VisiFlo color-coding, includes Quick TeeJet cap and gasket

Air Induction Turbo TwinJet® Twin Flat Spray Tips



Typical Applications:

See selection guide on page 4 for recommended typical applications for Air Induction Turbo TwinJet tips.

Features:

- Air induction with dual 110° flat fan patterns
- 60° between leading and trailing spray patterns
- Good coverage with increased canopy penetration and best drift control

- Best suited for postemergence applications
- Excellent drift control with coarse to very coarse droplets
- Available in nine VisiFlo® color coded capacities (02 through 15)—color represents total flow
- Pressure ranges from 20–90 PSI (1.5–6 bar)
- Automatic spray alignment when used with 25598-*-NYR (02–06) or 98579-1-NYR (08–15) Quick TeeJet® cap and gasket. See page 64 for additional information.

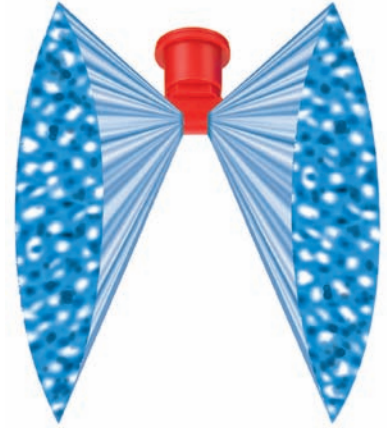

Tip Model	PSI	DROPSIZE	CAPACITY ONE NOZZLE IN GPM	CAPACITY ONE NOZZLE IN OZ./MIN.	20"															
					GPA								GALLONS PER 1000 SQ. FT.							
					4 MPH	5 MPH	6 MPH	8 MPH	10 MPH	12 MPH	15 MPH	20 MPH	2 MPH	3 MPH	4 MPH	5 MPH				
AITTJ60-11002VVP (100)	20	XC	0.14	18	10.4	8.3	6.9	5.2	4.2	3.5	2.8	2.1	0.48	0.32	0.24	0.19				
	30	VC	0.17	22	12.6	10.1	8.4	6.3	5.0	4.2	3.4	2.5	0.58	0.39	0.29	0.23				
	40	VC	0.20	26	14.9	11.9	9.9	7.4	5.9	5.0	4.0	3.0	0.68	0.45	0.34	0.27				
	50	C	0.22	28	16.3	13.1	10.9	8.2	6.5	5.4	4.4	3.2	0.75	0.50	0.37	0.30				
	60	C	0.24	31	17.8	14.3	11.9	8.9	7.1	5.9	4.8	3.6	0.82	0.54	0.41	0.33				
AITTJ60-110025VVP (100)	20	XC	0.18	23	13.4	10.7	8.9	6.7	5.3	4.5	3.6	2.7	0.61	0.41	0.31	0.24				
	30	VC	0.22	28	16.3	13.1	10.9	8.2	6.5	5.4	4.4	3.3	0.75	0.50	0.37	0.30				
	40	VC	0.25	32	18.6	14.9	12.4	9.3	7.4	6.2	5.0	3.7	0.85	0.57	0.43	0.34				
	50	C	0.28	36	21	16.6	13.9	10.4	8.3	6.9	5.5	4.2	0.95	0.63	0.48	0.38				
	60	C	0.31	40	23	18.4	15.3	11.5	9.2	7.7	6.1	4.6	1.1	0.70	0.53	0.42				
AITTJ60-11003VVP (50)	20	UC	0.21	27	15.6	12.5	10.4	7.8	6.2	5.2	4.2	3.1	0.71	0.48	0.36	0.29				
	30	XC	0.26	33	19.3	15.4	12.9	9.7	7.7	6.4	5.1	3.9	0.88	0.59	0.44	0.35				
	40	VC	0.30	38	22	17.8	14.9	11.1	8.9	7.4	5.9	4.5	1.0	0.68	0.51	0.41				
	50	VC	0.34	44	25	20	16.8	12.6	10.1	8.4	6.7	5.0	1.2	0.77	0.58	0.46				
	60	C	0.37	47	27	22	18.3	13.7	11.0	9.2	7.3	5.5	1.3	0.84	0.63	0.50				
AITTJ60-11004VP (50)	20	UC	0.28	36	21	16.6	13.9	10.4	8.3	6.9	5.5	4.2	0.95	0.63	0.48	0.38				
	30	XC	0.35	45	26	21	17.3	13.0	10.4	8.7	6.9	5.2	1.2	0.79	0.60	0.48				
	40	VC	0.40	51	30	24	19.8	14.9	11.9	9.9	7.9	5.9	1.4	0.91	0.68	0.54				
	50	VC	0.45	58	33	27	22	16.7	13.4	11.1	8.9	6.7	1.5	1.0	0.77	0.61				
	60	C	0.49	63	36	29	24	18.2	14.6	12.1	9.7	7.3	1.7	1.1	0.83	0.67				
AITTJ60-11005VVP (50)	20	UC	0.42	54	31	25	21	15.6	12.5	10.4	8.3	6.2	1.4	0.95	0.71	0.57				
	30	XC	0.43	55	32	26	21	16.0	12.8	10.6	8.5	6.4	1.5	0.97	0.73	0.58				
	40	XC	0.50	64	37	30	25	18.6	14.9	12.4	9.9	7.4	1.7	1.1	0.85	0.68				
	50	VC	0.56	72	42	33	28	21	16.6	13.9	11.1	8.3	1.9	1.3	0.95	0.76				
	60	VC	0.61	78	45	36	30	23	18.1	15.1	12.1	9.1	2.1	1.4	1.0	0.83				
AITTJ60-11006VVP (50)	20	UC	0.42	54	31	25	21	15.6	12.5	10.4	8.3	6.2	1.4	0.95	0.71	0.57				
	30	XC	0.52	67	39	31	26	19.3	15.4	12.9	10.3	7.7	1.8	1.2	0.88	0.71				
	40	XC	0.60	77	45	36	30	22	17.8	14.9	11.9	8.9	2.0	1.4	1.0	0.82				
	50	VC	0.67	86	50	40	33	25	19.9	16.6	13.3	9.9	2.3	1.5	1.1	0.91				
	60	VC	0.73	93	54	43	36	27	22	18.1	14.5	10.8	2.5	1.7	1.2	0.99				
AITTJ60-11008VVP (50)	20	UC	0.57	73	42	34	28	21	16.9	14.1	11.3	8.5	1.9	1.3	0.97	0.78				
	30	XC	0.69	88	51	41	34	26	20	17.1	13.7	10.2	2.3	1.6	1.2	0.94				
	40	XC	0.80	102	59	48	40	30	24	19.8	15.8	11.9	2.7	1.8	1.4	1.09				
	50	XC	0.89	114	66	53	44	33	26	22	17.6	13.2	3.0	2.0	1.5	1.2				
	60	VC	0.98	125	73	58	49	36	29	24	19.4	14.6	3.3	2.2	1.7	1.3				
AITTJ60-11010VVP (50)	20	UC	0.71	91	53	42	35	26	21	17.6	14.1	10.5	2.4	1.6	1.2	0.97				
	30	UC	0.87	111	65	52	43	32	26	22	17.2	12.9	3.0	2.0	1.5	1.2				
	40	UC	1.00	128	74	59	50	37	30	25	19.8	14.9	3.4	2.3	1.7	1.4				
	50	XC	1.12	143	83	67	55	42	33	28	22	16.6	3.8	2.5	1.9	1.5				
	60	XC	1.22	156	91	72	60	45	36	30	24	18.1	4.1	2.8	2.1	1.7				
AITTJ60-11015VVP (50)	20	UC	1.06	136	79	63	52	39	31	26	21	15.7	3.6	2.4	1.8	1.4				
	30	UC	1.30	166	97	77	64	48	39	32	26	19.3	4.4	2.9	2.2	1.8				
	40	UC	1.50	192	111	89	74	56	45	37	30	22	5.1	3.4	2.6	2.0				
	50	XC	1.68	215	125	100	83	62	50	42	33	25	5.7	3.8	2.9	2.3				
	60	XC	1.84	236	137	109	91	68	55	46	36	27	6.3	4.2	3.1	2.5				
AITTJ60-11004VP-C	20	UC	1.06	136	79	63	52	39	31	26	21	15.7	3.6	2.4	1.8	1.4				
	30	UC	1.30	166	97	77	64	48	39	32	26	19.3	4.4	2.9	2.2	1.8				
	40	UC	1.50	192	111	89	74	56	45	37	30	22	5.1	3.4	2.6	2.0				

Note: Always double check your application rates. Tabulations are based on spraying water at 70°F (21°C). See pages 136–157 for drop size classification, useful formulas and other information.

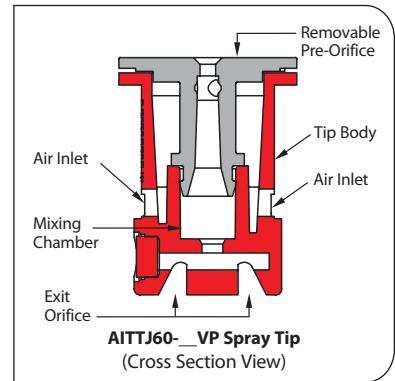

CONTACT PRODUCT	SYSTEMIC PRODUCT	DRIFT MANAGEMENT
GOOD	EXCELLENT	EXCELLENT

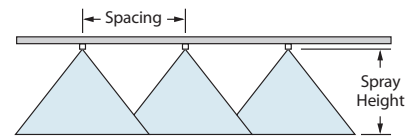

Optimum Spray Height

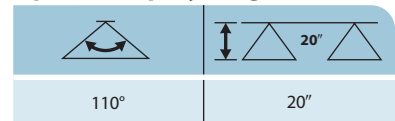

How to order:

Specify tip number.

Example:

- AITTJ60-11004VP – Polymer with VisiFlo® color-coding
- AITTJ60-11004VP-C – Polymer with VisiFlo color-coding, includes Quick TeeJet cap and gasket



AI3070[®] Air Induction Dual Pattern Flat Spray Tips

Typical Applications:

See selection guide on page 4 for recommended typical applications for AI3070 tips.

Features:

- Provides excellent penetration and seed head coverage for fungicide spraying on cereal crops.
- AI3070 produces two wide angle, flat spray patterns for uniform coverage in broadcast applications.

- 30° forward tilted spray penetrates dense crop canopies, while the backward tilted 70° spray maximizes coverage of the crop seed head.
- Drift resistant drops are produced through the use of a venturi air aspirator.
- All acetel construction for excellent chemical and wear resistance.
- Removable pre-orifice for fast and easy cleaning.
- Suggested spray pressure range of 20–90 PSI (1.5–6 bar).
- Automatic alignment with the use of 98579-1-NYR Quick TeeJet[®] cap and gasket. Reference page 64 for more information.

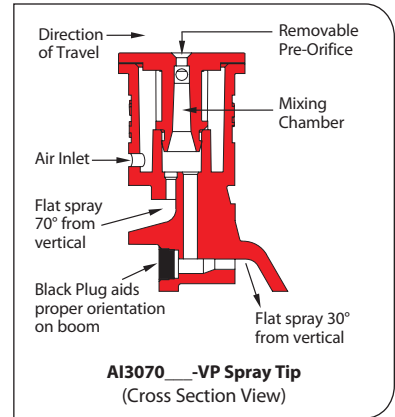
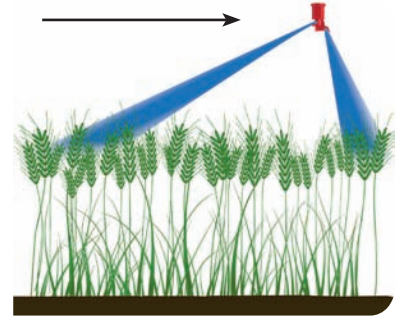

TIPO	PSI	DROP SIZE	CAPACITY ONE NOZZLE IN GPM	CAPACITY ONE NOZZLE IN OZ./MIN.	20"															
					GPA								GALLONS PER 1000 SQ. FT.							
					4 MPH	5 MPH	6 MPH	8 MPH	10 MPH	12 MPH	15 MPH	20 MPH	2 MPH	3 MPH	4 MPH	5 MPH				
AI3070-015VP (100)	20	VC	0.11	14	8.2	6.5	5.4	4.1	3.3	2.7	2.2	1.6	0.37	0.25	0.19	0.15				
	30	C	0.13	17	9.7	7.7	6.4	4.8	3.9	3.2	2.6	1.9	0.44	0.29	0.22	0.18				
	40	C	0.15	19	11.1	8.9	7.4	5.6	4.5	3.7	3.0	2.2	0.51	0.34	0.26	0.20				
	50	M	0.17	22	12.6	10.1	8.4	6.3	5.0	4.2	3.4	2.5	0.58	0.39	0.29	0.23				
	60	M	0.18	23	13.4	10.7	8.9	6.7	5.3	4.5	3.6	2.7	0.61	0.41	0.31	0.24				
	70	M	0.20	26	14.9	11.9	9.9	7.4	5.9	5.0	4.0	3.0	0.68	0.45	0.34	0.27				
AI3070-02VP (100)	80	M	0.21	27	15.6	12.5	10.4	7.8	6.2	5.2	4.2	3.1	0.71	0.48	0.36	0.29				
	90	F	0.23	29	17.1	13.7	11.4	8.5	6.8	5.7	4.6	3.4	0.78	0.52	0.39	0.31				
	20	XC	0.14	18	10.4	8.3	6.9	5.2	4.2	3.5	2.8	2.1	0.48	0.32	0.24	0.19				
	30	VC	0.17	22	12.6	10.1	8.4	6.3	5.0	4.2	3.4	2.5	0.58	0.39	0.29	0.23				
	40	C	0.20	26	14.9	11.9	9.9	7.4	5.9	5.0	4.0	3.0	0.68	0.45	0.34	0.27				
	50	C	0.22	28	16.3	13.1	10.9	8.2	6.5	5.4	4.4	3.3	0.75	0.50	0.37	0.30				
AI3070-025VP (100)	60	C	0.24	31	17.8	14.3	11.9	8.9	7.1	5.9	4.8	3.6	0.82	0.54	0.41	0.33				
	70	M	0.26	33	19.3	15.4	12.9	9.7	7.7	6.4	5.1	3.9	0.88	0.59	0.44	0.35				
	80	M	0.28	36	21	16.6	13.9	10.4	8.3	6.9	5.5	4.2	0.95	0.63	0.48	0.38				
	90	M	0.30	38	22	17.8	14.9	11.1	8.9	7.4	5.9	4.5	1.0	0.68	0.51	0.41				
	20	XC	0.18	23	13.4	10.7	8.9	6.7	5.3	4.5	3.6	2.7	0.61	0.41	0.31	0.24				
	30	VC	0.22	28	16.3	13.1	10.9	8.2	6.5	5.4	4.4	3.3	0.75	0.50	0.37	0.30				
AI3070-03VP (50)	40	C	0.25	32	18.6	14.9	12.4	9.3	7.4	6.2	5.0	3.7	0.85	0.57	0.43	0.34				
	50	C	0.28	36	21	16.6	13.9	10.4	8.3	6.9	5.5	4.2	0.95	0.63	0.48	0.38				
	60	C	0.31	40	23	18.4	15.3	11.5	9.2	7.7	6.1	4.6	1.1	0.70	0.53	0.42				
	70	C	0.33	42	25	19.6	16.3	12.3	9.8	8.2	6.5	4.9	1.1	0.75	0.56	0.45				
	80	C	0.35	45	26	21	17.3	13.0	10.4	8.7	6.9	5.2	1.2	0.79	0.60	0.48				
	90	M	0.38	49	28	23	18.8	14.1	11.3	9.4	7.5	5.6	1.3	0.86	0.65	0.52				
AI3070-04VP (50)	20	XC	0.21	27	15.6	12.5	10.4	7.8	6.2	5.2	4.2	3.1	0.71	0.48	0.36	0.29				
	30	XC	0.26	33	19.3	15.4	12.9	9.7	7.7	6.4	5.1	3.9	0.88	0.59	0.44	0.35				
	40	VC	0.30	38	22	17.8	14.9	11.1	8.9	7.4	5.9	4.5	1.0	0.68	0.51	0.41				
	50	C	0.34	44	25	20	16.8	12.6	10.1	8.4	6.7	5.0	1.2	0.77	0.58	0.46				
	60	C	0.37	47	27	22	18.3	13.7	11.0	9.2	7.3	5.5	1.3	0.84	0.63	0.50				
	70	C	0.40	51	30	24	19.8	14.9	11.9	9.9	7.9	5.9	1.4	0.91	0.68	0.54				
AI3070-05VP (50)	80	C	0.42	54	31	25	21	15.6	12.5	10.4	8.3	6.2	1.4	0.95	0.71	0.57				
	90	C	0.45	58	33	27	22	16.7	13.4	11.1	8.9	6.7	1.5	1.0	0.77	0.61				
	20	UC	0.28	36	21	16.6	13.9	10.4	8.3	6.9	5.5	4.2	0.95	0.63	0.48	0.38				
	30	XC	0.35	45	26	21	17.3	13.0	10.4	8.7	6.9	5.2	1.2	0.79	0.60	0.48				
	40	VC	0.40	51	30	24	19.8	14.9	11.9	9.9	7.9	5.9	1.4	0.91	0.68	0.54				
	50	VC	0.45	58	33	27	22	16.7	13.4	11.1	8.9	6.7	1.5	1.0	0.77	0.61				
AI3070-05VP (50)	60	VC	0.49	63	36	29	24	18.2	14.6	12.1	9.7	7.3	1.7	1.1	0.83	0.67				
	70	C	0.53	68	39	31	26	19.7	15.7	13.1	10.5	7.9	1.8	1.2	0.90	0.72				
	80	C	0.57	73	42	34	28	21	16.9	14.1	11.3	8.5	1.9	1.3	0.97	0.78				
	90	C	0.60	77	45	36	30	22	17.8	14.9	11.9	8.9	2.0	1.4	1.0	0.82				
	20	UC	0.35	45	26	21	17.3	13.0	10.4	8.7	6.9	5.2	1.2	0.79	0.60	0.48				
	30	XC	0.43	55	32	26	21	16.0	12.8	10.6	8.5	6.4	1.5	0.97	0.73	0.58				
AI3070-05VP (50)	40	VC	0.50	64	37	30	25	18.6	14.9	12.4	9.9	7.4	1.7	1.1	0.85	0.68				
	50	VC	0.56	72	42	33	28	21	16.6	13.9	11.1	8.3	1.9	1.3	0.95	0.76				
	60	VC	0.61	78	45	36	30	23	18.1	15.1	12.1	9.1	2.1	1.4	1.0	0.83				
	70	C	0.66	84	49	39	33	25	19.6	16.3	13.1	9.8	2.2	1.5	1.1	0.90				
	80	C	0.71	91	53	42	35	26	21	17.6	14.1	10.5	2.4	1.6	1.2	0.97				
	90	C	0.75	96	56	45	37	28	22	18.6	14.9	11.1	2.6	1.7	1.3	1.0				

Note: Always double check your application rates. Tabulations are based on spraying water at 70°F (21°C). See pages 136–157 for drop size classification, useful formulas and other information.

CONTACT PRODUCT	SYSTEMIC PRODUCT	DRIFT MANAGEMENT
EXCELLENT	VERY GOOD	EXCELLENT

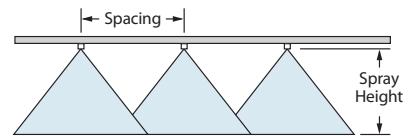

Optimum Spray Height

Spacing	Spray Height
15"	9"
20"	12"
30"	18"

How to order:

Specify tip number.

Example:

- AI3070-04VP – Polymer with VisiFlo[®] color-coding
- AI3070-03VP-C – Polymer with VisiFlo color-coding, includes Quick TeeJet cap and gasket

Turbo TeeJet® Duo Dual Polymer Flat Fan Spray Tips



Features:

- Two Turbo TeeJet tapered edge flat fan spray tips using a QJ90-2-NYR adapter to produce a twin-type pattern spraying forward and back. See page 5 for more information on Turbo TeeJet spray tips.
- Provides more versatility than the standard twin-type spray tip. Depending on the Turbo TeeJet tip orientation, a 60°, 90° or 120° included angle can be achieved.
- Best suited for broadcast spraying where superior leaf coverage and canopy penetration is important.
- QJ90 adapter and Quick TeeJet® caps are made of nylon. Turbo TeeJet tips are made of Acetal for excellent wear life and chemical resistance. See page 66 for additional information about the QJ90-2-NYR adapter.
- Ideal for use with automatic sprayer controls.
- Recommended operating pressure range is 15–90 PSI (1–6 bar).
- Quick TeeJet caps (included) are colored to match the VisiFlo® color-coding of spray tips. See page 64 for additional information.



PSI	DROP SIZE	CAPACITY ONE TT DUO IN GPM	CAPACITY ONE TT DUO IN OZ./MIN.	20°																													
				GPA								GALLONS PER 1000 SQ. FT.																					
				4 MPH	5 MPH	6 MPH	8 MPH	10 MPH	12 MPH	15 MPH	20 MPH	2 MPH	3 MPH	4 MPH	5 MPH																		
QJ90-2XTT11001 (100)	15	C	0.12	15	8.9	7.1	5.9	4.5	3.6	3.0	2.4	1.8	0.41	0.27	0.20	0.16	QJ90-2XTT110015 (100)	15	VC	0.18	23	13.4	10.7	8.9	6.7	5.3	4.5	3.6	2.7	0.61	0.41	0.31	0.24
	20	C	0.14	18	10.4	8.3	6.9	5.2	4.2	3.5	2.8	2.1	0.48	0.32	0.24	0.19		20	C	0.21	27	15.6	12.5	10.4	7.8	6.2	5.2	4.2	3.1	0.71	0.48	0.36	0.29
	30	M	0.17	22	12.6	10.1	8.4	6.3	5.0	4.2	3.4	2.5	0.58	0.39	0.29	0.23		30	M	0.26	33	19.3	15.4	12.9	9.7	7.7	6.4	5.1	3.9	0.88	0.59	0.44	0.35
	40	M	0.20	26	14.9	11.9	9.9	7.4	5.9	5.0	4.0	3.0	0.68	0.45	0.34	0.27		40	M	0.30	38	22	17.8	14.9	11.1	8.9	7.4	5.9	4.5	1.0	0.68	0.51	0.41
	50	M	0.22	28	16.3	13.1	10.9	8.2	6.5	5.4	4.4	3.3	0.75	0.50	0.37	0.30		50	M	0.34	44	25	20	16.8	12.6	10.1	8.4	6.7	5.0	1.2	0.77	0.58	0.46
	60	F	0.24	31	17.8	14.3	11.9	8.9	7.1	5.9	4.8	3.6	0.82	0.54	0.41	0.33		60	F	0.37	47	27	22	18.3	13.7	11.0	9.2	7.3	5.5	1.3	0.84	0.63	0.50
75	F	0.27	35	20	16.0	13.4	10.0	8.0	6.7	5.3	4.0	0.92	0.61	0.46	0.37	75	F	0.41	52	30	24	20	15.2	12.2	10.1	8.1	6.1	1.4	0.93	0.70	0.56		
90	F	0.30	38	22	17.8	14.9	11.1	8.9	7.4	5.9	4.5	1.0	0.68	0.51	0.41	90	F	0.45	58	33	27	22	16.7	13.4	11.1	8.9	6.7	1.5	1.0	0.77	0.61		
QJ90-2XTT11002 (50)	15	VC	0.24	31	17.8	14.3	11.9	8.9	7.1	5.9	4.8	3.6	0.82	0.54	0.41	0.33	QJ90-2XTT110025 (50)	15	VC	0.31	40	23	18.4	15.3	11.5	9.2	7.7	6.1	4.6	1.1	0.70	0.53	0.42
	20	VC	0.28	36	21	16.6	13.9	10.4	8.3	6.9	5.5	4.2	0.95	0.63	0.48	0.38		20	VC	0.35	45	26	21	17.3	13.0	10.4	8.7	6.9	5.2	1.2	0.79	0.60	0.48
	30	C	0.35	45	26	21	17.3	13.0	10.4	8.7	6.9	5.2	1.2	0.79	0.60	0.48		30	C	0.43	55	32	26	21	16.0	12.8	10.6	8.5	6.4	1.5	0.97	0.73	0.58
	40	M	0.40	51	30	24	19.8	14.9	11.9	9.9	7.9	5.9	1.4	0.91	0.68	0.54		40	M	0.50	64	37	30	25	18.6	14.9	12.4	9.9	7.4	1.7	1.1	0.85	0.68
	50	M	0.45	58	33	27	22	16.7	13.4	11.1	8.9	6.7	1.5	1.0	0.77	0.61		50	M	0.56	72	42	33	28	21	16.6	13.9	11.1	8.3	1.9	1.3	0.95	0.76
	60	M	0.49	63	36	29	24	18.2	14.6	12.1	9.7	7.3	1.7	1.1	0.83	0.67		60	M	0.61	78	45	36	30	23	18.1	15.1	12.1	9.1	2.1	1.4	1.0	0.83
75	F	0.55	70	41	33	27	20	16.3	13.6	10.9	8.2	1.9	1.2	0.94	0.75	75	F	0.68	87	50	40	34	25	20	16.8	13.5	10.1	2.3	1.5	1.2	0.92		
90	F	0.60	77	45	36	30	22	17.8	14.9	11.9	8.9	2.0	1.4	1.0	0.82	90	F	0.75	96	56	45	37	28	22	18.6	14.9	11.1	2.6	1.7	1.3	1.0		
QJ90-2XTT11003 (50)	15	VC	0.37	47	27	22	18.3	13.7	11.0	9.2	7.3	5.5	1.3	0.84	0.63	0.50	QJ90-2XTT11004 (50)	15	XC	0.49	63	36	29	24	18.2	14.6	12.1	9.7	7.3	1.7	1.1	0.83	0.67
	20	VC	0.42	54	31	25	21	15.6	12.5	10.4	8.3	6.2	1.4	0.95	0.71	0.57		20	VC	0.57	73	42	34	28	21	16.9	14.1	11.3	8.5	1.9	1.3	0.97	0.78
	30	C	0.52	67	39	31	26	19.3	15.4	12.9	10.3	7.7	1.8	1.2	0.88	0.71		30	C	0.69	88	51	41	34	26	20	17.1	13.7	10.2	2.3	1.6	1.2	0.94
	40	C	0.60	77	45	36	30	22	17.8	14.9	11.9	8.9	2.0	1.4	1.0	0.82		40	C	0.80	102	59	48	40	30	24	19.8	15.8	11.9	2.7	1.8	1.4	1.1
	50	M	0.67	86	50	40	33	25	19.9	16.6	13.3	9.9	2.3	1.5	1.1	0.91		50	M	0.89	114	66	53	44	33	26	22	17.6	13.2	3.0	2.0	1.5	1.2
	60	M	0.73	93	54	43	36	27	22	18.1	14.5	10.8	2.5	1.7	1.2	0.99		60	M	0.98	125	73	58	49	36	29	24	19.4	14.6	3.3	2.2	1.7	1.3
75	M	0.82	105	61	49	41	30	24	20	16.2	12.2	2.8	1.9	1.4	1.1	75	M	1.10	141	82	65	54	41	33	27	22	16.3	3.7	2.5	1.9	1.5		
90	F	0.90	115	67	53	45	33	27	22	17.8	13.4	3.1	2.0	1.5	1.2	90	M	1.20	154	89	71	59	45	36	30	24	17.8	4.1	2.7	2.0	1.6		
QJ90-2XTT11005 (50)	15	XC	0.61	78	45	36	30	23	18.1	15.1	12.1	9.1	2.1	1.4	1.0	0.83	QJ90-2XTT11006 (50)	15	XC	0.73	93	54	43	36	27	22	18.1	14.5	10.8	2.5	1.7	1.2	0.99
	20	VC	0.71	91	53	42	35	26	21	17.6	14.1	10.5	2.4	1.6	1.2	0.97		20	VC	0.85	109	63	50	42	32	25	21	16.8	12.6	2.9	1.9	1.4	1.2
	30	VC	0.87	111	65	52	43	32	26	22	17.2	12.9	3.0	2.0	1.5	1.2		30	VC	1.04	133	77	62	51	39	31	26	21	15.4	3.5	2.4	1.8	1.4
	40	C	1.00	128	74	59	50	37	30	25	19.8	14.9	3.4	2.3	1.7	1.4		40	VC	1.20	154	89	71	59	45	36	30	24	17.8	4.1	2.7	2.0	1.6
	50	C	1.12	143	83	67	55	42	33	28	22	16.6	3.8	2.5	1.9	1.5		50	C	1.34	172	99	80	66	50	40	33	27	19.9	4.6	3.0	2.3	1.8
	60	M	1.22	156	91	72	60	45	36	30	24	18.1	4.1	2.8	2.1	1.7		60	C	1.47	188	109	87	73	55	44	36	29	22	5.0	3.3	2.5	2.0
75	M	1.37	175	102	81	68	51	41	34	27	20	4.7	3.1	2.3	1.9	75	M	1.64	210	122	97	81	61	49	41	32	24	5.6	3.7	2.8	2.2		
90	M	1.50	192	111	89	74	56	45	37	30	22	5.1	3.4	2.6	2.0	90	M	1.80	230	134	107	89	67	53	45	36	27	6.1	4.1	3.1	2.4		
QJ90-2XTT11008 (50)	15	XC	0.98	125	73	58	49	36	29	24	19.4	4.6	3.3	2.2	1.7	1.3	QJ90-2XTT11008 (50)	15	XC	1.13	145	84	67	56	42	34	28	22	16.8	3.8	2.6	1.9	1.5
	20	VC	1.13	145	84	67	56	42	34	28	22	16.8	3.8	2.6	1.9	1.5		20	VC	1.39	178	103	83	69	52	41	34	28	21	4.7	3.2	2.4	1.9
	30	VC	1.39	178	103	83	69	52	41	34	28	21	4.7	3.2	2.4	1.9		30	C	1.60	205	119	95	79	59	48	40	32	24	5.4	3.6	2.7	2.2
	40	C	1.60	205	119	95	79	59	48	40	32	24	5.4	3.6	2.7	2.2		40	C	1.79	229	133	106	89	66	53	44	35	27	6.1	4.1	3.0	2.4
	50	C	1.79	229	133	106	89	66	53	44	35	27	6.1	4.1	3.0	2.4		50	C	1.96	251	146	116	97	73	58	49	39	29	6.7	4.4	3.3	2.7
	60	C	1.96	251	146	116	97	73	58	49	39	29	6.7	4.4	3.3	2.7		60	C	2.19	280	163	130	108	81	65	54	43	33	7.4	5.0	3.7	3.0
75	M	2.19	280	163	130	108	81	65	54	43	33	7.4	5.0	3.7	3.0	75	M	2.40	307	178	143	119	89	71	59	48	36	8.2	5.4	4.1	3.3		
90	M	2.40	307	178	143	119	89	71	59	48	36	8.2	5.4	4.1	3.3	90	M	2.40	307	178	143	119	89	71	59	48	36	8.2	5.4	4.1	3.3		

CONTACT PRODUCT	SYSTEMIC PRODUCT	DRIFT MANAGEMENT
EXCELLENT	EXCELLENT	VERY GOOD
VERY GOOD*	EXCELLENT*	EXCELLENT*

*At pressures below 30 PSI (2.0 bar)

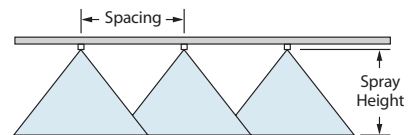

Optimum Spray Height

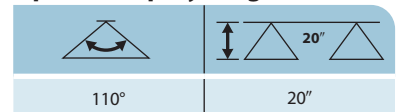

How to order:

Specify tip number.

Example:

QJ90-2XTT11004-VP – Polymer with VisiFlo color-coding

Note: Always double check your application rates. Tabulations are based on spraying water at 70°F (21°C). See pages 136–157 for drop size classification, useful formulas and other information.



TXR ConeJet® Hollow Cone Spray Tips

Typical Applications:

Use for broadcast application of insecticides, fungicides, defoliants and foliar fertilizers at pressures of 40 PSI (3 bar) and above.

Features:

- Produces uniform, 80° hollow cone spray pattern.
- Flow rates are matched to serve as a direct replacement for commonly used non-TeeJet hollow cone spray tips.

- High-quality ceramic orifice provides superior wear life, including high-pressure operation.
- Low profile acetal tip body provides minimal impact with foliage and excellent chemical resistance.
- Color-coded holder based on tip flow rate allows for easy capacity identification.

- Snap-fit backup plate provides positive retention when handled in field, but allows for tool-free removal for easy cleaning.
- Suggested spray pressure range of 30–360 PSI (2–25 bar).
- Uses 114396-1-NYR Quick TeeJet® cap, gasket and O-ring. Reference page 64 for more information.



Icon	PSI	DROP SIZE	CAPACITY ONE NOZZLE IN GPM	CAPACITY ONE NOZZLE IN OZ./MIN.	20°															
					GPA								GALLONS PER 1000 SQ. FT.							
					4 MPH	5 MPH	6 MPH	8 MPH	10 MPH	12 MPH	15 MPH	20 MPH	2 MPH	3 MPH	4 MPH	5 MPH				
TXR800053VK (100)	40	VF	0.053	6.8	3.9	3.1	2.6	2.0	1.6	1.3	1.0	0.79	0.18	0.12	0.09	0.07				
	50	VF	0.059	7.6	4.4	3.5	2.9	2.2	1.8	1.5	1.2	0.88	0.20	0.13	0.10	0.08				
	60	VF	0.064	8.2	4.8	3.8	3.2	2.4	1.9	1.6	1.3	0.95	0.22	0.15	0.11	0.09				
	70	VF	0.069	8.8	5.1	4.1	3.4	2.6	2.0	1.7	1.4	1.0	0.23	0.16	0.12	0.09				
	80	VF	0.073	9.3	5.4	4.3	3.6	2.7	2.2	1.8	1.4	1.1	0.25	0.17	0.12	0.10				
90	VF	0.077	9.9	5.7	4.6	3.8	2.9	2.3	1.9	1.5	1.1	0.26	0.17	0.13	0.10					
TXR800071VK (50)	40	VF	0.071	9.1	5.3	4.2	3.5	2.6	2.1	1.8	1.4	1.1	0.24	0.16	0.12	0.10				
	50	VF	0.079	10	5.9	4.7	3.9	2.9	2.3	2.0	1.6	1.2	0.27	0.18	0.13	0.11				
	60	VF	0.086	11	6.4	5.1	4.3	3.2	2.6	2.1	1.7	1.3	0.29	0.19	0.15	0.12				
	70	VF	0.093	12	6.9	5.5	4.6	3.5	2.8	2.3	1.8	1.4	0.32	0.21	0.16	0.13				
	80	VF	0.099	13	7.4	5.9	4.9	3.7	2.9	2.5	2.0	1.5	0.34	0.22	0.17	0.13				
90	VF	0.11	14	8.2	6.5	5.4	4.1	3.3	2.7	2.2	1.6	0.37	0.25	0.19	0.15					
TXR8001VK (50)	40	F	0.10	13	7.4	5.9	5.0	3.7	3.0	2.5	2.0	1.5	0.34	0.23	0.17	0.14				
	50	VF	0.11	14	8.2	6.5	5.4	4.1	3.3	2.7	2.2	1.6	0.37	0.25	0.19	0.15				
	60	VF	0.12	15	8.9	7.1	5.9	4.5	3.6	3.0	2.4	1.8	0.41	0.27	0.20	0.16				
	70	VF	0.13	17	9.7	7.7	6.4	4.8	3.9	3.2	2.6	1.9	0.44	0.29	0.22	0.18				
	80	VF	0.14	18	10.4	8.3	6.9	5.2	4.2	3.5	2.8	2.1	0.48	0.32	0.24	0.19				
90	VF	0.15	19	11.1	8.9	7.4	5.6	4.5	3.7	3.0	2.2	0.51	0.34	0.26	0.20					
TXR80013VK (50)	40	F	0.13	17	9.7	7.7	6.4	4.8	3.9	3.2	2.6	1.9	0.44	0.29	0.22	0.18				
	50	VF	0.15	19	11.1	8.9	7.4	5.6	4.5	3.7	3.0	2.2	0.51	0.34	0.26	0.20				
	60	VF	0.16	20	11.9	9.5	7.9	5.9	4.8	4.0	3.2	2.4	0.54	0.36	0.27	0.22				
	70	VF	0.17	22	12.6	10.1	8.4	6.3	5.0	4.2	3.4	2.5	0.58	0.39	0.29	0.23				
	80	VF	0.19	24	14.1	11.3	9.4	7.1	5.6	4.7	3.8	2.8	0.65	0.43	0.32	0.26				
90	VF	0.20	26	14.9	11.9	9.9	7.4	5.9	5.0	4.0	3.0	0.68	0.45	0.34	0.27					
TXR80015VK (50)	40	F	0.15	19	11.1	8.9	7.4	5.6	4.5	3.7	3.0	2.2	0.51	0.34	0.26	0.20				
	50	F	0.17	22	12.6	10.1	8.4	6.3	5.0	4.2	3.4	2.5	0.58	0.39	0.29	0.23				
	60	F	0.18	23	13.4	10.7	8.9	6.7	5.3	4.5	3.6	2.7	0.61	0.41	0.31	0.24				
	70	F	0.20	26	14.9	11.9	9.9	7.4	5.9	5.0	4.0	3.0	0.68	0.45	0.34	0.27				
	80	VF	0.21	27	15.6	12.5	10.4	7.8	6.2	5.2	4.2	3.1	0.71	0.48	0.36	0.29				
90	VF	0.22	28	16.3	13.1	10.9	8.2	6.5	5.4	4.4	3.3	0.75	0.50	0.37	0.30					
TXR80017VK (50)	40	F	0.17	22	12.6	10.1	8.4	6.3	5.0	4.2	3.4	2.5	0.58	0.39	0.29	0.23				
	50	F	0.19	24	14.1	11.3	9.4	7.1	5.6	4.7	3.8	2.8	0.65	0.43	0.32	0.26				
	60	F	0.20	26	14.9	11.9	9.9	7.4	5.9	5.0	4.0	3.0	0.68	0.45	0.34	0.27				
	70	VF	0.22	28	16.3	13.1	10.9	8.2	6.5	5.4	4.4	3.3	0.75	0.50	0.37	0.30				
	80	VF	0.23	29	17.1	13.7	11.4	8.5	6.8	5.7	4.6	3.4	0.78	0.52	0.39	0.31				
90	VF	0.25	32	18.6	14.9	12.4	9.3	7.4	6.2	5.0	3.7	0.85	0.57	0.43	0.34					
TXR8002VK (50)	40	F	0.20	26	14.9	11.9	9.9	7.4	5.9	5.0	4.0	3.0	0.68	0.45	0.34	0.27				
	50	F	0.22	28	16.3	13.1	10.9	8.2	6.5	5.4	4.4	3.3	0.75	0.50	0.37	0.30				
	60	F	0.24	31	17.8	14.3	11.9	8.9	7.1	5.9	4.8	3.6	0.82	0.54	0.41	0.33				
	70	VF	0.26	33	19.3	15.4	12.9	9.7	7.7	6.4	5.1	3.9	0.88	0.59	0.44	0.35				
	80	VF	0.28	36	21	16.6	13.9	10.4	8.3	6.9	5.5	4.2	0.95	0.63	0.48	0.38				
90	VF	0.30	38	22	17.8	14.9	11.1	8.9	7.4	5.9	4.5	1.0	0.68	0.51	0.41					
TXR80028VK (50)	40	F	0.28	36	21	16.6	13.9	10.4	8.3	6.9	5.5	4.2	0.95	0.63	0.48	0.38				
	50	F	0.31	40	23	18.4	15.3	11.5	9.2	7.7	6.1	4.6	1.1	0.70	0.53	0.42				
	60	F	0.33	42	25	19.6	16.3	12.3	9.8	8.2	6.5	4.9	1.1	0.75	0.56	0.45				
	70	F	0.36	46	27	21	17.8	13.4	10.7	8.9	7.1	5.3	1.2	0.82	0.61	0.49				
	80	VF	0.38	49	28	23	18.8	14.1	11.3	9.4	7.5	5.6	1.3	0.86	0.65	0.52				
90	VF	0.41	52	30	24	20	15.2	12.2	10.1	8.1	6.1	1.4	0.93	0.70	0.56					
TXR8003VK (50)	40	F	0.30	38	22	17.8	14.9	11.1	8.9	7.4	5.9	4.5	1.0	0.68	0.51	0.41				
	50	F	0.34	44	25	20	16.8	12.6	10.1	8.4	6.7	5.0	1.2	0.77	0.58	0.46				
	60	F	0.37	47	27	22	18.3	13.7	11.0	9.2	7.3	5.5	1.3	0.84	0.63	0.50				
	70	F	0.40	51	30	24	19.8	14.9	11.9	9.9	7.9	5.9	1.4	0.91	0.68	0.54				
	80	F	0.42	54	31	25	21	15.6	12.5	10.4	8.3	6.2	1.4	0.95	0.71	0.57				
90	VF	0.45	58	33	27	22	16.7	13.4	11.1	8.9	6.7	1.5	1.0	0.77	0.61					
TXR80036VK (50)	40	F	0.36	46	27	21	17.8	13.4	10.7	8.9	7.1	5.3	1.2	0.82	0.61	0.49				
	50	F	0.40	51	30	24	19.8	14.9	11.9	9.9	7.9	5.9	1.4	0.91	0.68	0.54				
	60	F	0.44	56	33	26	22	16.3	13.1	10.9	8.7	6.5	1.5	1.0	0.75	0.60				
	70	F	0.47	60	35	28	23	17.4	14.0	11.6	9.3	7.0	1.6	1.1	0.80	0.64				
	80	F	0.50	64	37	30	25	18.6	14.9	12.4	9.9	7.4	1.7	1.1	0.85	0.68				
90	VF	0.53	68	39	31	26	19.7	15.7	13.1	10.5	7.9	1.8	1.2	0.90	0.72					
TXR8004VK (50)	40	F	0.40	51	30	24	19.8	14.9	11.9	9.9	7.9	5.9	1.4	0.91	0.68	0.54				
	50	F	0.45	58	33	27	22	16.7	13.4	11.1	8.9	6.7	1.5	1.0	0.77	0.61				
	60	F	0.49	63	36	29	24	18.2	14.6	12.1	9.7	7.3	1.7	1.1	0.83	0.67				
	70	F	0.53	68	39	31	26	19.7	15.7	13.1	10.5	7.9	1.8	1.2	0.90	0.72				
	80	F	0.56	72	42	33	28	21	16.6	13.9	11.1	8.3	1.9	1.3	0.95	0.76				
90	VF	0.60	77	45	36	30	22	17.8	14.9	11.9	8.9	2.0	1.4	1.0	0.82					
TXR80049VK (50)	40	F	0.49	63	36	29	24	18.2	14.6	12.1	9.7	7.3	1.7	1.1	0.83	0.67				
	50	F	0.55	70	41	33	27	20	16.3	13.6	10.9	8.2	1.9	1.2	0.94	0.75				
	60	F	0.60	77	45	36	30	22	17.8	14.9	11.9	8.9	2.0	1.4	1.0	0.82				
	70	F	0.64	82	48	38	32	24	19.0	15.8	12.7	9.5	2.2	1.5	1.1	0.87				
	80	F	0.69	88	51	41	34	26	20	17.1	13.7	10.2	2.3	1.6	1.2	0.94				
90	F	0.73	93	54	43	36	27	22	18.1	14.5	10.8	2.5	1.7	1.2	0.99					

Note: Always double check your application rates. Tabulations are based on spraying water at 70°F (21°C). See pages 136–157 for drop size classification, useful formulas and other information.

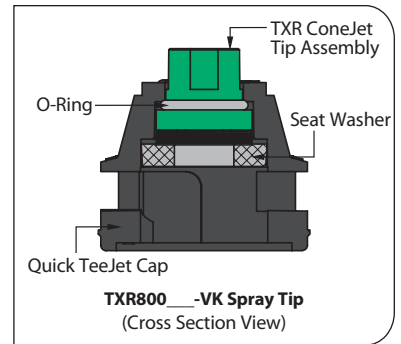

CONTACT PRODUCT	SYSTEMIC PRODUCT	DRIFT MANAGEMENT
EXCELLENT	—	—

*At pressures below 30 PSI (2.0 bar)

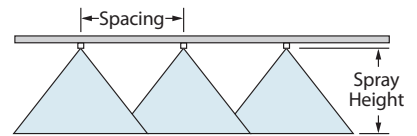

Optimum Spray Height

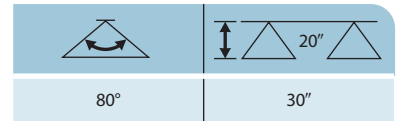

How to order:

Specify tip number.

Examples:

- TXR8003VK – Ceramic with color-coding
- TXR8003VK-100X – Ceramic with color-coding, 100 tips



Typical Applications:

See selection guide on page 4 for recommended typical applications for TwinJet tips.

Features:

- Penetrates crop residue or dense foliage.
- Smaller droplets for thorough coverage.
- Better spray distribution along boom than with hollow cone nozzles.
- Available in stainless steel with VisiFlo® color-coding in 65°, 80° and 110° spray angles.
- Recommended pressure rating 30–60 PSI (2–4 bar).
- See page 36 for TwinJet even flat spray tips.
- Automatic spray alignment with 25598-*-NYR Quick TeeJet® cap and gasket. Reference page 64 for more information.

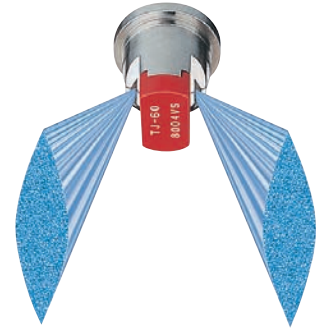

Tip Model	PSI	DROPS PER MIN	CAPACITY ONE NOZZLE IN GPM	CAPACITY ONE NOZZLE IN OZ./MIN.	20°												GALLONS PER 1000 SQ. FT.				
					GPA																
					4 MPH	5 MPH	6 MPH	8 MPH	10 MPH	12 MPH	15 MPH	20 MPH	2 MPH	3 MPH	4 MPH	5 MPH					
TJ60-6501 TJ60-8001 (100)	30	VF	0.087	11	6.5	5.2	4.3	3.2	2.6	2.2	1.7	1.3	0.30	0.20	0.15	0.12					
	35	VF	0.094	12	7.0	5.6	4.7	3.5	2.8	2.3	1.9	1.4	0.32	0.21	0.16	0.13					
	40	VF	0.10	13	7.4	5.9	5.0	3.7	3.0	2.5	2.0	1.5	0.34	0.23	0.17	0.14					
	50	VF	0.11	14	8.2	6.5	5.4	4.1	3.3	2.7	2.2	1.6	0.37	0.25	0.19	0.15					
TJ60-650134 (100)	30		0.12	15	8.9	7.1	5.9	4.5	3.6	3.0	2.4	1.8	0.41	0.27	0.20	0.16					
	35		0.13	17	9.7	7.7	6.4	4.8	3.9	3.2	2.6	1.9	0.44	0.29	0.22	0.18					
	40		0.134	17	9.9	8.0	6.6	5.0	4.0	3.3	2.7	2.0	0.46	0.30	0.23	0.18					
	50		0.15	19	11.1	8.9	7.4	5.6	4.5	3.7	3.0	2.2	0.51	0.34	0.26	0.20					
TJ60-6502 TJ60-8002 TJ60-11002 (100)	30	F	0.17	22	12.6	10.1	8.4	6.3	5.0	4.2	3.4	2.5	0.58	0.39	0.29	0.23					
	35	F	0.19	24	14.1	11.3	9.4	7.1	5.6	4.7	3.8	2.8	0.65	0.43	0.32	0.26					
	40	F	0.20	26	14.9	11.9	9.9	7.4	5.9	5.0	4.0	3.0	0.68	0.45	0.34	0.27					
	50	F	0.22	28	16.3	13.1	10.9	8.2	6.5	5.4	4.4	3.3	0.75	0.50	0.37	0.30					
TJ60-6503 TJ60-8003 TJ60-11003 (100)	30	F	0.26	33	19.3	15.4	12.9	9.7	7.7	6.4	5.1	3.9	0.88	0.59	0.44	0.35					
	35	F	0.28	36	21	16.6	13.9	10.4	8.3	6.9	5.5	4.2	0.95	0.63	0.48	0.38					
	40	F	0.30	38	22	17.8	14.9	11.1	8.9	7.4	5.9	4.5	1.0	0.68	0.51	0.41					
	50	F	0.34	44	25	20	16.8	12.6	10.1	8.4	6.7	5.0	1.2	0.77	0.58	0.46					
TJ60-6504 TJ60-8004 TJ60-11004 (50)	30	M	0.35	45	26	21	17.3	13.0	10.4	8.7	6.9	5.2	1.2	0.79	0.60	0.48					
	35	M	0.37	47	27	22	18.3	13.7	11.0	9.2	7.3	5.5	1.3	0.84	0.63	0.50					
	40	F	0.40	51	30	24	19.8	14.9	11.9	9.9	7.9	5.9	1.4	0.91	0.68	0.54					
	50	F	0.45	58	33	27	22	16.7	13.4	11.1	8.9	6.7	1.5	1.0	0.77	0.61					
TJ60-8005 TJ60-11005 (50)	30	M	0.43	55	32	26	21	16.0	12.8	10.6	8.5	6.4	1.5	0.97	0.73	0.58					
	35	M	0.47	60	35	28	23	17.4	14.0	11.6	9.3	7.0	1.6	1.07	0.80	0.64					
	40	M	0.50	64	37	30	25	18.6	14.9	12.4	9.9	7.4	1.7	1.13	0.85	0.68					
	50	F	0.56	72	42	33	28	21	16.6	13.9	11.1	8.3	1.9	1.3	0.95	0.76					
TJ60-6506 TJ60-8006 TJ60-11006 (50)	30	M	0.61	78	45	36	30	23	18.1	15.1	12.1	9.1	2.1	1.4	1.04	0.83					
	35	M	0.52	67	39	31	26	19.3	15.4	12.9	10.3	7.7	1.8	1.2	0.88	0.71					
	40	M	0.56	72	42	33	28	21	16.6	13.9	11.1	8.3	1.9	1.3	0.95	0.76					
	50	M	0.60	77	45	36	30	22	17.8	14.9	11.9	8.9	2.0	1.4	1.0	0.82					
TJ60-6508 TJ60-8008 TJ60-11008 (50)	30	M	0.67	86	50	40	33	25	19.9	16.6	13.3	9.9	2.3	1.5	1.1	0.91					
	35	M	0.73	93	54	43	36	27	22	18.1	14.5	10.8	2.5	1.7	1.2	0.99					
	40	M	0.69	88	51	41	34	26	20	17.1	13.7	10.2	2.3	1.6	1.2	0.94					
	50	M	0.75	96	56	45	37	28	22	18.6	14.9	11.1	2.6	1.7	1.3	1.0					
TJ60-8010 TJ60-11010 (50)	30	C	0.80	102	59	48	40	30	24	19.8	15.8	11.9	2.7	1.8	1.4	1.1					
	35	C	0.89	114	66	53	44	33	26	22	17.6	13.2	3.0	2.0	1.5	1.2					
	40	M	0.98	125	73	58	49	36	29	24	19.4	14.6	3.3	2.2	1.7	1.3					
	50	M	1.11	141	83	67	55	42	33	28	22	16.6	3.8	2.5	1.9	1.5					
TJ60-8010 TJ60-11010 (50)	30	C	0.87	111	65	52	43	32	26	22	17.2	12.9	3.0	2.0	1.5	1.2					
	35	C	0.94	120	70	56	47	35	28	23	18.6	14.0	3.2	2.1	1.6	1.3					
	40	C	1.00	128	74	59	50	37	30	25	19.8	14.9	3.4	2.3	1.7	1.4					
	50	M	1.12	143	83	67	55	42	33	28	22	16.6	3.8	2.5	1.9	1.5					
TJ60-8010 TJ60-11010 (50)	60	M	1.22	156	91	72	60	45	36	30	24	18.1	4.1	2.8	2.1	1.7					

Note: Always double check your application rates. Tabulations are based on spraying water at 70°F (21°C). See pages 136–157 for drop size classification, useful formulas and other information.

CONTACT PRODUCT	SYSTEMIC PRODUCT	DRIFT MANAGEMENT
EXCELLENT	—	—

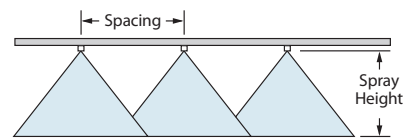

Optimum Spray Height

Spray Angle	Optimum Spray Height
65°	35"
80°	30"
110°	20"

How to order:

Specify tip number.

Example:

TJ60-8002VS – Stainless Steel with VisiFlo color-coding



DG TwinJet® Drift Guard Twin Flat Spray Tips

Typical Applications:

See selection guide on page 4 for recommended typical applications for DG TwinJet tips.

Features:

- Dual 110°, tapered edge, flat fan spray patterns spraying 60° forward to back providing uniform coverage in broadcast spraying applications.
- DG TwinJet offers larger droplets and improved drift control compared to a standard TwinJet spray tip of equal capacity.
- Dual angled spray patterns help to better penetrate crop canopy and provide thorough leaf coverage.
- Made of stainless steel with VisiFlo® color-coding for excellent chemical and wear resistance.
- Removable polymer pre-orifice.
- Available in six capacities with a recommended pressure range of 30–60 PSI (2–4 bar).
- Automatic spray alignment when used with 25598-/-NYR Quick TeeJet® cap and gasket. Reference page 64 for more information.

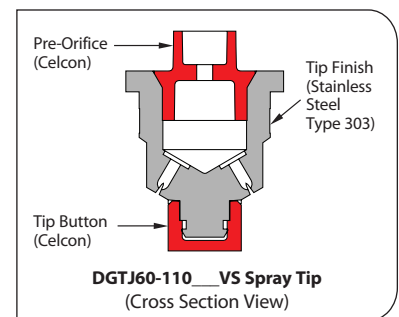
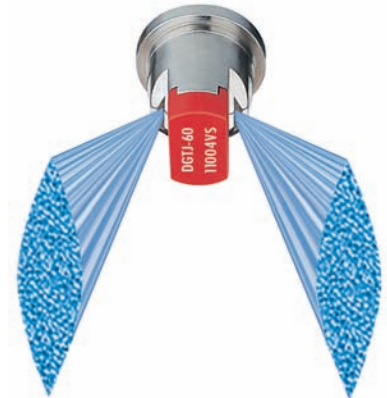

Note: Due to pre-orifice design, this tip is not compatible with the 4193A check valve tip strainer.

Icon	PSI	DROP SIZE	CAPACITY ONE NOZZLE IN GPM	CAPACITY ONE NOZZLE IN OZ./MIN.	20°																					
					GPA								GALLONS PER 1000 SQ. FT.													
					4 MPH	5 MPH	6 MPH	8 MPH	10 MPH	12 MPH	15 MPH	20 MPH	2 MPH	3 MPH	4 MPH	5 MPH										
DGTJ60-110015 (100)	30	F	0.13	17	9.7	7.7	6.4	4.8	3.9	3.2	2.6	1.9	0.44	0.29	0.22	0.18										
	35	F	0.14	18	10.4	8.3	6.9	5.2	4.2	3.5	2.8	2.1	0.48	0.32	0.24	0.19										
	40	F	0.15	19	11.1	8.9	7.4	5.6	4.5	3.7	3.0	2.2	0.51	0.34	0.26	0.20										
	50	F	0.17	22	12.6	10.1	8.4	6.3	5.0	4.2	3.4	2.5	0.58	0.39	0.29	0.23										
DGTJ60-11002 (100)	30	M	0.17	22	12.6	10.1	8.4	6.3	5.0	4.2	3.4	2.5	0.58	0.39	0.29	0.23										
	35	M	0.19	24	14.1	11.3	9.4	7.1	5.6	4.7	3.8	2.8	0.65	0.43	0.32	0.26										
	40	M	0.20	26	14.9	11.9	9.9	7.4	5.9	5.0	4.0	3.0	0.68	0.45	0.34	0.27										
	50	F	0.22	28	16.3	13.1	10.9	8.2	6.5	5.4	4.4	3.3	0.75	0.50	0.37	0.30										
DGTJ60-11003 (100)	30	M	0.26	33	19.3	15.4	12.9	9.7	7.7	6.4	5.1	3.9	0.88	0.59	0.44	0.35										
	35	M	0.28	36	21	16.6	13.9	10.4	8.3	6.9	5.5	4.2	0.95	0.63	0.48	0.38										
	40	M	0.30	38	22	17.8	14.9	11.1	8.9	7.4	5.9	4.5	1.0	0.68	0.51	0.41										
	50	F	0.34	44	25	20	16.8	12.6	10.1	8.4	6.7	5.0	1.2	0.77	0.58	0.46										
DGTJ60-11004 (50)	30	C	0.35	45	26	21	17.3	13.0	10.4	8.7	6.9	5.2	1.2	0.79	0.60	0.48										
	35	C	0.37	47	27	22	18.3	13.7	11.0	9.2	7.3	5.5	1.3	0.84	0.63	0.50										
	40	C	0.40	51	30	24	19.8	14.9	11.9	9.9	7.9	5.9	1.4	0.91	0.68	0.54										
	50	C	0.45	58	33	27	22	16.7	13.4	11.1	8.9	6.7	1.5	1.0	0.77	0.61										
DGTJ60-11006 (50)	30	C	0.49	63	36	29	24	18.2	14.6	12.1	9.7	7.3	1.7	1.1	0.83	0.67										
	30	C	0.52	67	39	31	26	19.3	15.4	12.9	10.3	7.7	1.8	1.2	0.88	0.71										
	35	C	0.56	72	42	33	28	21	16.6	13.9	11.1	8.3	1.9	1.3	0.95	0.76										
	40	C	0.60	77	45	36	30	22	17.8	14.9	11.9	8.9	2.0	1.4	1.0	0.82										
DGTJ60-11008 (50)	50	C	0.67	86	50	40	33	25	19.9	16.6	13.3	9.9	2.3	1.5	1.1	0.91										
	60	C	0.73	93	54	43	36	27	22	18.1	14.5	10.8	2.5	1.7	1.2	0.99										
	30	C	0.69	88	51	41	34	26	20	17.1	13.7	10.2	2.3	1.6	1.2	0.94										
	35	C	0.75	96	56	45	37	28	22	18.6	14.9	11.1	2.6	1.7	1.3	1.0										
DGTJ60-11008 (50)	40	C	0.80	102	59	48	40	30	24	19.8	15.8	11.9	2.7	1.8	1.4	1.1										
	50	C	0.89	114	66	53	44	33	26	22	17.6	13.2	3.0	2.0	1.5	1.2										
	60	C	0.98	125	73	58	49	36	29	24	19.4	14.6	3.3	2.2	1.7	1.3										

Note: Always double check your application rates. Tabulations are based on spraying water at 70°F (21°C). See pages 136–157 for drop size classification, useful formulas and other information.

CONTACT PRODUCT	SYSTEMIC PRODUCT	DRIFT MANAGEMENT
VERY GOOD	EXCELLENT	VERY GOOD

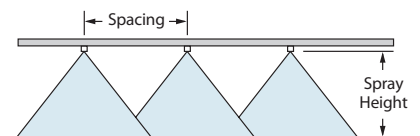

Optimum Spray Height

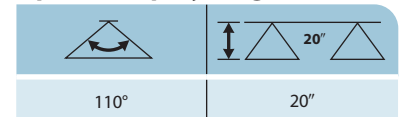

How to order:
Specify tip number.

Example:

DGTJ60-11004VS – Stainless Steel with VisiFlo color-coding

Turbo FloodJet® Wide Angle Flat Spray Tips



Typical Applications:

See selection guide on page 4 for recommended typical applications for Turbo FloodJet tips.

Features:

- Excellent spray distribution for uniform coverage along the boom.
- Nozzle design incorporates a pre-orifice to produce larger droplets for less drift.
- Large, round orifice reduces clogging.
- Stainless steel or polymer with VisiFlo® color-coding band for easy size identification.
- Can be used with CP25600-*-NYR Quick TeeJet® cap and gasket for automatic alignment. Reference page 64 for more information.

QCT Cam Lever Coupling Adapter

- Provides easy changeover from high capacity to lower capacity nozzles.
- Adapter fits standard 3/4" Cam lever coupling.
- Corrosion-resistant stainless steel and polypropylene construction.
- Rated up to 100 PSI (7 bar).
- Use QJT-NYB to retrofit to Quick TeeJet.



CONTACT PRODUCT	SYSTEMIC PRODUCT	DRIFT MANAGEMENT
—	VERY GOOD	EXCELLENT

Tip Size	PSI	DROP SIZE	CAPACITY ONE NOZZLE IN GPM	CAPACITY ONE NOZZLE IN OZ./MIN.	40"										20"									
					GPA																GALLONS PER 1000 SQ. FT.			
					4 MPH	5 MPH	6 MPH	8 MPH	10 MPH	12 MPH	15 MPH	20 MPH	2 MPH	3 MPH	4 MPH	5 MPH								
TF-†2 (50)	10	UC	0.20	26	7.4	5.9	5.0	3.7	3.0	2.5	2.0	1.5	0.68	0.45	0.34	0.27								
	20	XC	0.28	36	10.4	8.3	6.9	5.2	4.2	3.5	2.8	2.1	0.95	0.63	0.48	0.38								
	30	XC	0.35	45	13.0	10.4	8.7	6.5	5.2	4.3	3.5	2.6	1.2	0.79	0.60	0.48								
	40	VC	0.40	51	14.9	11.9	9.9	7.4	5.9	5.0	4.0	3.0	1.4	0.91	0.68	0.54								
TF-†2.5 (50)	10	UC	0.25	32	9.3	7.4	6.2	4.6	3.7	3.1	2.5	1.9	0.85	0.57	0.43	0.34								
	20	XC	0.35	45	13.0	10.4	8.7	6.5	5.2	4.3	3.5	2.6	1.2	0.79	0.60	0.48								
	30	XC	0.43	55	16.0	12.8	10.6	8.0	6.4	5.3	4.3	3.2	1.5	0.97	0.73	0.58								
	40	XC	0.50	64	18.6	14.9	12.4	9.3	7.4	6.2	5.0	3.7	1.7	1.1	0.85	0.68								
TF-†3 (50)	10	UC	0.30	38	11.1	8.9	7.4	5.6	4.5	3.7	3.0	2.2	1.0	0.68	0.51	0.41								
	20	UC	0.42	54	15.6	12.5	10.4	7.8	6.2	5.2	4.2	3.1	1.4	0.95	0.71	0.57								
	30	XC	0.52	67	19.3	15.4	12.9	9.7	7.7	6.4	5.1	3.9	1.8	1.2	0.88	0.71								
	40	XC	0.60	77	22	17.8	14.9	11.1	8.9	7.4	5.9	4.5	2.0	1.4	1.0	0.82								
TF-†4 (50)	10	UC	0.40	51	14.9	11.9	9.9	7.4	5.9	5.0	4.0	3.0	1.4	0.91	0.68	0.54								
	20	UC	0.57	73	21	16.9	14.1	10.6	8.5	7.1	5.6	4.2	1.9	1.3	0.97	0.78								
	30	XC	0.69	88	26	20	17.1	12.8	10.2	8.5	6.8	5.1	2.3	1.6	1.2	0.94								
	40	XC	0.80	102	30	24	19.8	14.9	11.9	9.9	7.9	5.9	2.7	1.8	1.4	1.1								
TF-†5	10	UC	0.50	64	18.6	14.9	12.4	9.3	7.4	6.2	5.0	3.7	1.7	1.1	0.85	0.68								
	20	UC	0.71	91	26	21	17.6	13.2	10.5	8.8	7.0	5.3	2.4	1.6	1.2	0.97								
	30	UC	0.87	111	32	26	22	16.1	12.9	10.8	8.6	6.5	3.0	2.0	1.5	1.2								
	40	XC	1.00	128	37	30	25	18.6	14.9	12.4	9.9	7.4	3.4	2.3	1.7	1.4								
TF-†7.5	10	UC	0.75	96	28	22	18.6	13.9	11.1	9.3	7.4	5.6	2.6	1.7	1.3	1.0								
	20	UC	1.06	136	39	31	26	19.7	15.7	13.1	10.5	7.9	3.6	2.4	1.8	1.4								
	30	UC	1.30	166	48	39	32	24	19.3	16.1	12.9	9.7	4.4	2.9	2.2	1.8								
	40	XC	1.50	192	56	45	37	28	22	18.6	14.9	11.1	5.1	3.4	2.6	2.0								
TF-†10	10	UC	1.00	128	37	30	25	18.6	14.9	12.4	9.9	7.4	3.4	2.3	1.7	1.4								
	20	UC	1.41	180	52	42	35	26	21	17.4	14.0	10.5	4.8	3.2	2.4	1.9								
	30	UC	1.73	221	64	51	43	32	26	21	17.1	12.8	5.9	3.9	2.9	2.4								
	40	XC	2.00	256	74	59	50	37	30	25	19.8	14.9	6.8	4.5	3.4	2.7								

Note: Always double check your application rates. Tabulations are based on spraying water at 70°F (21°C). See pages 136–157 for drop size classification, useful formulas and other information.

†Specify material.

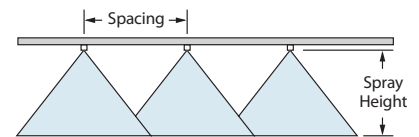

Optimum Spray Height

Spacing	Optimum Spray Height
20"	24"*
30"	30"*
40"	39"*

*Wide angle spray nozzle height is influenced by nozzle orientation. The critical factor is to achieve a minimum 30% overlap.

How to order:

Specify tip number.

Examples:

TF-VS4 – Stainless Steel with VisiFlo color-coding

TF-VP4 – Polymer with VisiFlo color-coding



Quick Turbo FloodJet® Wide Angle Flat Spray Tips

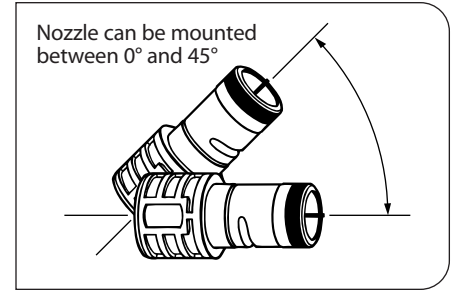

The revolutionary Quick Turbo FloodJet nozzle combines the precision and uniformity of a flat spray nozzle with the clog-resistance and wide angle pattern of flooding nozzles. It uses an exclusive new design to increase droplet size and distribution uniformity.

Features:

- Patented turbulence chamber creates a dramatic improvement in pattern uniformity.
- Pre-orifice design produces larger droplets for reduced drift.
- Large, round orifice reduces clogging.
- 1.26" (32 mm) diameter tip body fits into 3/4" cam lever coupling.

- Grooved side molding for automatic alignment.
- Stainless steel with color-coding for easy size identification.
- Available in standard sizes from 1.5 GPM up to 24.0 GPM (6.84 l/min to 94.73 l/min) at pressures of 10–40 PSI (1–3 bar).

How to order:

Specify tip number.

Example:

QCTF-VS40 – Stainless Steel with VisiFlo® color-coding

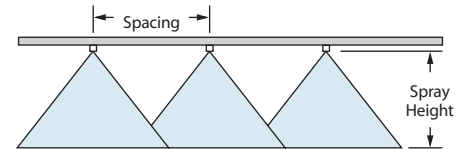

Optimum Spray Height*

40"	40"
60"	60"

*When nozzle is mounted parallel to the ground.

SOIL INCORPORATED	PRE-EMERGENCE	DRIFT MANAGEMENT
EXCELLENT	EXCELLENT	EXCELLENT

NOZZLE	PSI	CAPACITY ONE NOZZLE IN GPM	GPA LARGE CAPACITY QUICK FLOODJET NOZZLES TYPICAL SPACING IS 60 INCHES										
			4 MPH	5 MPH	6 MPH	7 MPH	8 MPH	9 MPH	10 MPH	12 MPH	14 MPH	16 MPH	18 MPH
QCTF-VS15	10	1.50	37	30	25	21	18.6	16.5	14.9	12.4	10.6	9.3	8.3
	20	2.12	52	42	35	30	26	23	21	17.5	15.0	13.1	11.7
	30	2.60	64	51	43	37	32	29	26	21	18.4	16.1	14.3
	40	3.00	74	59	50	42	37	33	30	25	21	18.6	16.5
QCTF-VS20	10	2.00	50	40	33	28	25	22	19.8	16.5	14.1	12.4	11.0
	20	2.83	70	56	47	40	35	31	28	23	20	17.5	15.6
	30	3.46	86	69	57	49	43	38	34	29	24	21	19.0
	40	4.00	99	79	66	57	50	44	40	33	28	25	22
QCTF-VS30	10	3.00	74	59	50	42	37	33	30	25	21	18.6	16.5
	20	4.24	105	84	70	60	52	47	42	35	30	26	23
	30	5.20	129	103	86	74	64	57	51	43	37	32	29
	40	6.00	149	119	99	85	74	66	59	50	42	37	33
QCTF-VS40	10	4.00	99	79	66	57	50	44	40	33	28	25	22
	20	5.66	140	112	93	80	70	62	56	47	40	35	31
	30	6.93	172	137	114	98	86	76	69	57	49	43	38
	40	8.00	198	158	132	113	99	88	79	66	57	50	44
QCTF-VS50	10	5.00	124	99	83	71	62	55	50	41	35	31	28
	20	7.07	175	140	117	100	87	78	70	58	50	44	39
	30	8.66	214	171	143	122	107	95	86	71	61	54	48
	40	10.00	248	198	165	141	124	110	99	83	71	62	55
QCTF-VS60	10	6.00	149	119	99	85	74	66	59	50	42	37	33
	20	8.49	210	168	140	120	105	93	84	70	60	53	47
	30	10.4	257	206	172	147	129	114	103	86	74	64	57
	40	12.0	297	238	198	170	149	132	119	99	85	74	66
QCTF-VS80	10	8.00	198	158	132	113	99	88	79	66	57	50	44
	20	11.3	280	224	186	160	140	124	112	93	80	70	62
	30	13.9	344	275	229	197	172	153	138	115	98	86	76
	40	16.0	396	317	264	226	198	176	158	132	113	99	88
QCTF-VS100	10	10.0	248	198	165	141	124	110	99	83	71	62	55
	20	14.1	349	279	233	199	174	155	140	116	100	87	78
	30	17.3	428	343	285	245	214	190	171	143	122	107	95
	40	20.0	495	396	330	283	248	220	198	165	141	124	110
QCTF-VS120	10	12.0	297	238	198	170	149	132	119	99	85	74	66
	20	17.0	421	337	281	240	210	187	168	140	120	105	94
	30	20.8	515	412	343	294	257	229	206	172	147	129	114
	40	24.0	594	475	396	339	297	264	238	198	170	149	132

Note: Always double check your application rates. Tabulations are based on spraying water at 70°F (21°C). See pages 136–157 for useful formulas and other information.

FloodJet[®] Wide Angle Flat Spray Tips



How to order: Specify tip number.

Examples:

- TK-VS5 – Stainless Steel with VisiFlo[®] color-coding
- TK-VP3 – Polymer with VisiFlo color-coding
- (B)1/4K-5 – Brass
- TK-SS5 – Stainless Steel
- (B)1/8K-SS5 – Stainless Steel
- QCK-SS100 – Stainless Steel with VisiFlo color-coding



Tip	PSI	CAPACITY ONE NOZZLE IN GPM	GPA 40°									
			4 MPH	5 MPH	6 MPH	8 MPH	10 MPH	12 MPH	15 MPH	20 MPH		
1/8K-50 TK-50 (100)	10	0.050	—	—	—	—	—	—	—	—	—	—
	20	0.071	2.6	2.1	1.8	1.3	1.1	0.88	0.70	0.53		
	30	0.087	3.2	2.6	2.2	1.6	1.3	1.1	0.86	0.65		
	40	0.10	3.7	3.0	2.5	1.9	1.5	1.2	0.99	0.74		
1/8K-75 TK-75 (100)	10	0.075	2.8	2.2	1.9	1.4	1.1	0.93	0.74	0.56		
	20	0.11	4.1	3.3	2.7	2.0	1.6	1.4	1.1	0.82		
	30	0.13	4.8	3.9	3.2	2.4	1.9	1.6	1.3	0.97		
	40	0.15	5.6	4.5	3.7	2.8	2.2	1.9	1.5	1.1		
1/8K-1 TK-1 (100)	10	0.10	3.7	3.0	2.5	1.9	1.5	1.2	0.99	0.74		
	20	0.14	5.2	4.2	3.5	2.6	2.1	1.7	1.4	1.0		
	30	0.17	6.3	5.0	4.2	3.2	2.5	2.1	1.7	1.3		
	40	0.20	7.4	5.9	5.0	3.7	3.0	2.5	2.0	1.5		
1/8K-1.5 TK-1.5 (50)	10	0.15	5.6	4.5	3.7	2.8	2.2	1.9	1.5	1.1		
	20	0.21	7.8	6.2	5.2	3.9	3.1	2.6	2.1	1.6		
	30	0.26	9.7	7.7	6.4	4.8	3.9	3.2	2.6	1.9		
	40	0.30	11.1	8.9	7.4	5.6	4.5	3.7	3.0	2.2		
1/8K, 1/4K, TK]-2 TK-2 (50)	10	0.20	7.4	5.9	5.0	3.7	3.0	2.5	2.0	1.5		
	20	0.28	10.4	8.3	6.9	5.2	4.2	3.5	2.8	2.1		
	30	0.35	13.0	10.4	8.7	6.5	5.2	4.3	3.5	2.6		
	40	0.40	14.9	11.9	9.9	7.4	5.9	5.0	4.0	3.0		
1/8K, 1/4K, TK]-2.5 TK-2.5 (50)	10	0.25	9.3	7.4	6.2	4.6	3.7	3.1	2.5	1.9		
	20	0.35	13.0	10.4	8.7	6.5	5.2	4.3	3.5	2.6		
	30	0.43	16.0	12.8	10.6	8.0	6.4	5.3	4.3	3.2		
	40	0.50	18.6	14.9	12.4	9.3	7.4	6.2	5.0	3.7		
1/8K, 1/4K, TK]-3 [TK]-3 (50)	10	0.30	11.1	8.9	7.4	5.6	4.5	3.7	3.0	2.2		
	20	0.42	15.6	12.5	10.4	7.8	6.2	5.2	4.2	3.1		
	30	0.52	19.3	15.4	12.9	9.7	7.7	6.4	5.1	3.9		
	40	0.60	22	17.8	14.9	11.1	8.9	7.4	5.9	4.5		
1/8K, TK]-4 TK-4 (50)	10	0.40	14.9	11.9	9.9	7.4	5.9	5.0	4.0	3.0		
	20	0.57	21	16.9	14.1	10.6	8.5	7.1	5.6	4.2		
	30	0.69	26	20	17.1	12.8	10.2	8.5	6.8	5.1		
	40	0.80	30	24	19.8	14.9	11.9	9.9	7.9	5.9		
1/8K, 1/4K, TK]-5 [TK]-5 (50)	10	0.50	18.6	14.9	12.4	9.3	7.4	6.2	5.0	3.7		
	20	0.71	26	21	17.6	13.2	10.5	8.8	7.0	5.3		
	30	0.87	32	26	22	16.1	12.9	10.8	8.6	6.5		
	40	1.00	37	30	25	18.6	14.9	12.4	9.9	7.4		
1/8K, 1/4K, TK]-7.5 TK-7.5 (50)	10	0.75	28	22	18.6	13.9	11.1	9.3	7.4	5.6		
	20	1.06	39	31	26	19.7	15.7	13.1	10.5	7.9		
	30	1.30	48	39	32	24	19.3	16.1	12.9	9.7		
	40	1.50	56	45	37	28	22	18.6	14.9	11.1		
1/8K, 1/4K, TK]-10 TK-10 (50)	10	1.00	37	30	25	18.6	14.9	12.4	9.9	7.4		
	20	1.41	52	42	35	26	21	17.4	14.0	10.5		
	30	1.73	64	51	43	32	26	21	17.1	12.8		
	40	2.00	74	59	50	37	30	25	19.8	14.9		
1/8K, 1/4K]-12	10	1.20	45	36	30	22	17.8	14.9	11.9	8.9		
	20	1.70	63	50	42	32	25	21	16.8	12.6		
	30	2.08	77	62	51	39	31	26	21	15.4		
	40	2.40	89	71	59	45	36	30	24	17.8		
1/8K, 1/4K]-15 TK-15	10	1.50	56	45	37	28	22	18.6	14.9	11.1		
	20	2.12	79	63	52	39	31	26	21	15.7		
	30	2.60	97	77	64	48	39	32	26	19.3		
	40	3.00	111	89	74	56	45	37	30	22		
1/8K, 1/4K]-18	10	1.80	67	53	45	33	27	22	17.8	13.4		
	20	2.55	95	76	63	47	38	32	25	19		
	30	3.12	116	93	77	58	46	39	31	23		
	40	3.60	134	107	89	67	53	45	36	27		
1/8K, 1/4K]-20 TK-20	10	2.00	74	59	50	37	30	25	19.8	14.9		
	20	2.83	105	84	70	53	42	35	28	21		
	30	3.46	128	103	86	64	51	43	34	26		
	40	4.00	149	119	99	74	59	50	40	30		
QCK-20	10	2.20	82	65	54	41	33	27	22	16.3		
	20	3.11	115	92	77	58	46	38	31	23		
	30	3.81	141	113	94	71	57	47	38	28		
	40	4.40	163	131	109	82	65	54	44	33		
1/4K-22	10	2.40	89	71	59	45	36	30	24	17.8		
	20	3.39	126	101	84	63	50	42	34	25		
	30	4.16	154	124	103	77	62	51	41	31		
	40	4.80	178	143	119	89	71	59	48	36		
1/4K-24	10	2.40	89	71	59	45	36	30	24	17.8		
	20	3.39	126	101	84	63	50	42	34	25		
	30	4.16	154	124	103	77	62	51	41	31		
	40	4.80	178	143	119	89	71	59	48	36		

Tip	PSI	CAPACITY ONE NOZZLE IN GPM	GPA 60°									
			4 MPH	5 MPH	6 MPH	8 MPH	10 MPH	12 MPH	15 MPH	20 MPH		
1/4K-27	10	2.70	67	53	45	33	27	22	17.8	13.4		
	20	3.82	95	76	63	47	38	32	25	18.9		
	30	4.68	116	93	77	58	46	39	31	23		
	40	5.40	134	107	89	67	53	45	36	27		
3/8K-30 TK-30	10	3.00	74	59	50	37	30	25	19.8	14.9		
	20	4.24	105	84	70	52	42	35	28	21		
	30	5.20	129	103	86	64	51	43	34	26		
	40	6.00	149	119	99	74	59	50	40	30		
QCK-30	10	3.50	87	69	58	43	35	29	23	17.3		
	20	4.95	123	98	82	61	49	41	33	25		
	30	6.06	150	120	100	75	60	50	40	30		
	40	7.00	173	139	116	87	69	58	46	35		
3/8K-35	10	4.00	99	79	66	50	40	33	26	19.8		
	20	5.66	140	112	93	70	56	47	37	28		
	30	6.93	172	137	114	86	69	57	46	34		
	40	8.00	198	158	132	99	79	66	53	40		
[3/8K, 1/2K]-40 QCK-40	10	4.50	111	89	74	56	45	37	30	22		
	20	6.36	157	126	105	79	63	52	42	31		
	30	7.79	193	154	129	96	77	64	51	39		
	40	9.00	223	178	149	111	89	74	59	45		
3/8K-45	10	5.00	124	99	83	62	50	41	33	25		
	20	7.07	175	140	117	87	70	58	47	35		
	30	8.66	214	171	143	107	86	71	57	43		
	40	10.0	248	198	165	124	99	83	66	50		
1/2K-50 QCK-50	10	6.00	149	119	99	74	59	50	40	30		
	20	8.49	210	168	140	105	84	70	56	42		
	30	10.4	257	206	171	129	103	86	69	51		
	40	12.0	297	238	198	149	119	99	79	59		
1/2K-60 QCK-60	10	7.00	173	139	116	87	69	58	46	35		
	20	9.90	245	196	163	123	98	82	65	49		
	30	12.1	300	240	200	150	120	100	80	60		
	40	14.0	347	277	231	173	139	116	92	69		
1/2K, 3/4K]-80 QCK-80	10	8.00	198	158	132	99	79	66	53	40		
	20	11.3	280	224	186	140	112	93	75	56		
	30	13.9	344	275	229	172	138	115	92	69		
	40	16.0	396	317	264	198	158	132	106	79		
1/2K, 3/4K]-90 QCK-90	10	9.00	223	178	149	111	89	74	59	45		
	20	12.7	314	251	210	157	126	105	84	63		
	30	15.6	386	309	257	193	154	129	103	77		
	40	18.0	446	356	297	223	178	149	119	89		
3/4K-100 QCK-100	10	10.0	248	198	165	124	99	83	66	50		
	20	14.1	349	279	233	174	140	116	93	70		
	30	17.3	428	343	285	214	171	143	114	86		
	40	20.0	495	396	330	248	198	165	132	99		
3/4K-110 QCK-110	10	11.0	272	218	182	136	109	91	73	54		
	20	15.6	386	309	257	193	154	129	103	77		
	30	19.										



TurfJet Wide Angle Flat Fan Spray Nozzles

Typical Applications:

See selection guide on page 4 for recommended typical applications for Wide Angle Flat Fan Spray Nozzles.

Features:

- Can be used with Quick TeeJet® cap QJ4676*-NYR.
- Very large droplets.

- Direct replacement for plastic hollow-cone, low-drift nozzles.
- More precise flow and distribution pattern.
- Large orifice reduces clogging.
- Nozzle spacing — 20–40" (50–100 cm).
- Spraying pressure — 25–75 PSI (1.5–5 bar).

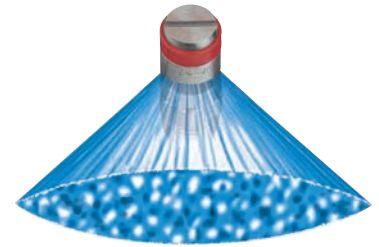

QJ4676-90-1/4-NYR

- 90° fitting attaches to Quick TeeJet bodies—1/4" female threaded outlet.
- Simple installation of TurfJet nozzles on vertical nozzle bodies.
- Nylon construction.



PSI	DROPSIZE	CAPACITY ONE NOZZLE IN GPM	CAPACITY ONE NOZZLE IN OZ./MIN.	40°										20°				
				GPA										GALLONS PER 1000 SQ. FT.				
				4 MPH	5 MPH	6 MPH	8 MPH	10 MPH	12 MPH	15 MPH	20 MPH	2 MPH	3 MPH	4 MPH	5 MPH			
1/4TTJ02 (50)	25 UC	0.16	20	5.9	4.8	4.0	3.0	2.4	2.0	1.6	1.2	0.54	0.36	0.27	0.22			
	30 UC	0.17	22	6.3	5.0	4.2	3.2	2.5	2.1	1.7	1.3	0.58	0.39	0.29	0.23			
	40 UC	0.20	26	7.4	5.9	5.0	3.7	3.0	2.5	2.0	1.5	0.68	0.45	0.34	0.27			
	50 XC	0.22	28	8.2	6.5	5.4	4.1	3.3	2.7	2.2	1.6	0.75	0.50	0.37	0.30			
	60 XC	0.24	31	8.9	7.1	5.9	4.5	3.6	3.0	2.4	1.8	0.82	0.54	0.41	0.33			
75 XC	0.27	35	10.0	8.0	6.7	5.0	4.0	3.3	2.7	2.0	0.92	0.61	0.46	0.37				
1/4TTJ04 (50)	25 UC	0.32	41	11.9	9.5	7.9	5.9	4.8	4.0	3.2	2.4	1.1	0.73	0.54	0.44			
	30 UC	0.35	45	13.0	10.4	8.7	6.5	5.2	4.3	3.5	2.6	1.2	0.79	0.60	0.48			
	40 UC	0.40	51	14.9	11.9	9.9	7.4	5.9	5.0	4.0	3.0	1.4	0.91	0.68	0.54			
	50 UC	0.45	58	16.7	13.4	11.1	8.4	6.7	5.6	4.5	3.3	1.5	1.0	0.77	0.61			
	60 UC	0.49	63	18.2	14.6	12.1	9.1	7.3	6.1	4.9	3.6	1.7	1.1	0.83	0.67			
75 UC	0.55	70	20	16.3	13.6	10.2	8.2	6.8	5.4	4.1	1.9	1.2	0.94	0.75				
1/4TTJ05 (50)	25 UC	0.40	51	14.9	11.9	9.9	7.4	5.9	5.0	4.0	3.0	1.4	0.91	0.68	0.54			
	30 UC	0.43	55	16.0	12.8	10.6	8.0	6.4	5.3	4.3	3.2	1.5	0.97	0.73	0.58			
	40 UC	0.50	64	18.6	14.9	12.4	9.3	7.4	6.2	5.0	3.7	1.7	1.1	0.85	0.68			
	50 UC	0.56	72	21	16.6	13.9	10.4	8.3	6.9	5.5	4.2	1.9	1.3	0.95	0.76			
	60 UC	0.61	78	23	18.1	15.1	11.3	9.1	7.5	6.0	4.5	2.1	1.4	1.0	0.83			
75 UC	0.68	87	25	20	16.8	12.6	10.1	8.4	6.7	5.0	2.3	1.5	1.2	0.92				
1/4TTJ06 (50)	25 UC	0.47	60	17.4	14.0	11.6	8.7	7.0	5.8	4.7	3.5	1.6	1.1	0.80	0.64			
	30 UC	0.52	67	19.3	15.4	12.9	9.7	7.7	6.4	5.1	3.9	1.8	1.2	0.88	0.71			
	40 UC	0.60	77	22	17.8	14.9	11.1	8.9	7.4	5.9	4.5	2.0	1.4	1.0	0.82			
	50 UC	0.67	86	25	19.9	16.6	12.4	9.9	8.3	6.6	5.0	2.3	1.5	1.1	0.91			
	60 UC	0.73	93	27	22	18.1	13.6	10.8	9.0	7.2	5.4	2.5	1.7	1.2	0.99			
75 UC	0.82	105	30	24	20	15.2	12.2	10.1	8.1	6.1	2.8	1.9	1.4	1.1				
1/4TTJ08	25 UC	0.63	81	23	18.7	15.6	11.7	9.4	7.8	6.2	4.7	2.1	1.4	1.1	0.86			
	30 UC	0.69	88	26	20	17.1	12.8	10.2	8.5	6.8	5.1	2.3	1.6	1.2	0.94			
	40 UC	0.80	102	30	24	19.8	14.9	11.9	9.9	7.9	5.9	2.7	1.8	1.4	1.1			
	50 UC	0.89	114	33	26	22	16.5	13.2	11.0	8.8	6.6	3.0	2.0	1.5	1.2			
	60 UC	0.98	125	36	29	24	18.2	14.6	12.1	9.7	7.3	3.3	2.2	1.7	1.3			
75 UC	1.10	141	41	33	27	20	16.3	13.6	10.9	8.2	3.7	2.5	1.9	1.5				
1/4TTJ10	25 UC	0.79	101	29	23	19.6	14.7	11.7	9.8	7.8	5.9	2.7	1.8	1.3	1.1			
	30 UC	0.87	111	32	26	22	16.1	12.9	10.8	8.6	6.5	3.0	2.0	1.5	1.2			
	40 UC	1.00	128	37	30	25	18.6	14.9	12.4	9.9	7.4	3.4	2.3	1.7	1.4			
	50 UC	1.12	143	42	33	28	21	16.6	13.9	11.1	8.3	3.8	2.5	1.9	1.5			
	60 UC	1.22	156	45	36	30	23	18.1	15.1	12.1	9.1	4.1	2.8	2.1	1.7			
75 UC	1.37	175	51	41	34	25	20	17.0	13.6	10.2	4.7	3.1	2.3	1.9				
1/4TTJ15	25 UC	1.19	152	44	35	29	22	17.7	14.7	11.8	8.8	4.0	2.7	2.0	1.6			
	30 UC	1.30	166	48	39	32	24	19.3	16.1	12.9	9.7	4.4	2.9	2.2	1.8			
	40 UC	1.50	192	56	45	37	28	22	18.6	14.9	11.1	5.1	3.4	2.6	2.0			
	50 UC	1.68	215	62	50	42	31	25	21	16.6	12.5	5.7	3.8	2.9	2.3			
	60 UC	1.84	236	68	55	46	34	27	23	18.2	13.7	6.3	4.2	3.1	2.5			
75 UC	2.05	262	76	61	51	38	30	25	20	15.2	7.0	4.6	3.5	2.8				

Note: Always double check your application rates. Tabulations are based on spraying water at 70°F (21°C). See pages 136–157 for drop size classification, useful formulas and other information.

CONTACT PRODUCT	SYSTEMIC PRODUCT	DRIFT MANAGEMENT
—	EXCELLENT	EXCELLENT

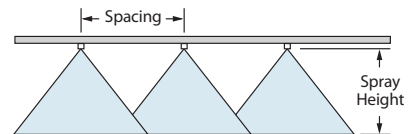

Optimum Spray Height

20"	24"*
30"	30"*
40"	39"*

*Wide angle spray nozzle height is influenced by nozzle orientation. The critical factor is to achieve a minimum 30% overlap.

How to order:

Specify tip number.

Examples:

- 1/4TTJ04-VS – Stainless Steel with VisiFlo® color-coding
- 1/4TTJ06-VP – Polymer with VisiFlo color-coding

TeeJet® Double Outlet Flat Spray Tips



150° Series Stainless Steel and Brass

Suggested for post-directed application with hose drops.

How to order:

Specify tip number and material.
Example: TQ150-03-SS – Stainless Steel



PSI	CAPACITY ONE NOZZLE IN GPM	GPA \triangle 20'											
		4 MPH	5 MPH	6 MPH	7 MPH	8 MPH	9 MPH	10 MPH	12 MPH	14 MPH	16 MPH	18 MPH	
TQ150-01-SS (100)	20	0.071	5.3	4.2	3.5	3.0	2.6	2.3	2.1	1.8	1.5	1.3	1.2
	25	0.079	5.9	4.7	3.9	3.4	2.9	2.6	2.3	2.0	1.7	1.5	1.3
	30	0.087	6.5	5.2	4.3	3.7	3.2	2.9	2.6	2.2	1.8	1.6	1.4
	40	0.10	7.4	5.9	5.0	4.2	3.7	3.3	3.0	2.5	2.1	1.9	1.7
TQ150-015-SS (100)	20	0.11	8.2	6.5	5.4	4.7	4.1	3.6	3.3	2.7	2.3	2.0	1.8
	25	0.12	8.9	7.1	5.9	5.1	4.5	4.0	3.6	3.0	2.5	2.2	2.0
	30	0.13	9.7	7.7	6.4	5.5	4.8	4.3	3.9	3.2	2.8	2.4	2.1
	40	0.15	11.1	8.9	7.4	6.4	5.6	5.0	4.5	3.7	3.2	2.8	2.5
TQ150-02-SS (100)	20	0.14	10.4	8.3	6.9	5.9	5.2	4.6	4.2	3.5	3.0	2.6	2.3
	25	0.16	11.9	9.5	7.9	6.8	5.9	5.3	4.8	4.0	3.4	3.0	2.6
	30	0.17	12.6	10.1	8.4	7.2	6.3	5.6	5.0	4.2	3.6	3.2	2.8
	40	0.20	14.9	11.9	9.9	8.5	7.4	6.6	5.9	5.0	4.2	3.7	3.3
TQ150-03-SS (100)	20	0.21	15.6	12.5	10.4	8.9	7.8	6.9	6.2	5.2	4.5	3.9	3.5
	25	0.24	17.8	14.3	11.9	10.2	8.9	7.9	7.1	5.9	5.1	4.5	4.0
	30	0.26	19.3	15.4	12.9	11.0	9.7	8.6	7.7	6.4	5.5	4.8	4.3
	40	0.30	22	17.8	14.9	12.7	11.1	9.9	8.9	7.4	6.4	5.6	5.0
TQ150-04-SS (50)	20	0.28	21	16.6	13.9	11.9	10.4	9.2	8.3	6.9	5.9	5.2	4.6
	25	0.32	24	19.0	15.8	13.6	11.9	10.6	9.5	7.9	6.8	5.9	5.3
	30	0.35	26	21	17.3	14.9	13.0	11.6	10.4	8.7	7.4	6.5	5.8
	40	0.40	30	24	19.8	17.0	14.9	13.2	11.9	9.9	8.5	7.4	6.6
TQ150-05-SS (50)	20	0.35	26	21	17.3	14.9	13.0	11.6	10.4	8.7	7.4	6.5	5.8
	25	0.40	30	24	19.8	17.0	14.9	13.2	11.9	9.9	8.5	7.4	6.6
	30	0.43	32	26	21	18.2	16.0	14.2	12.8	10.6	9.1	8.0	7.1
	40	0.50	37	30	25	21	18.6	16.5	14.9	12.4	10.6	9.3	8.3
TQ150-06-SS (50)	20	0.42	31	25	21	17.8	15.6	13.9	12.5	10.4	8.9	7.8	6.9
	25	0.47	35	28	23	19.9	17.4	15.5	14.0	11.6	10.0	8.7	7.8
	30	0.52	39	31	26	22	19.3	17.2	15.4	12.9	11.0	9.7	8.6
	40	0.60	45	36	30	25	22	19.8	17.8	14.9	12.7	11.1	9.9
TQ150-08-SS (50)	20	0.57	42	34	28	24	21	18.8	16.9	14.1	12.1	10.6	9.4
	25	0.63	47	37	31	27	23	21	18.7	15.6	13.4	11.7	10.4
	30	0.69	51	41	34	29	26	23	20	17.1	14.6	12.8	11.4
	40	0.80	59	48	40	34	30	26	24	19.8	17.0	14.9	13.2
TQ150-09-SS (50)	20	0.64	48	38	32	27	24	21	19.0	15.8	13.6	11.9	10.6
	25	0.71	53	42	35	30	26	23	21	17.6	15.1	13.2	11.7
	30	0.78	58	46	39	33	29	26	23	19.3	16.5	14.5	12.9
	40	0.90	67	53	45	38	33	30	27	22	19.1	16.7	14.9
50	1.01	75	60	50	43	37	33	30	25	21	18.7	16.7	

Note: Always double check your application rates. Tabulations are based on spraying water at 70°F (21°C). See pages 136–157 for useful formulas and other information.

TeeJet® Off-Center Flat Spray Tips — Smaller Capacities

TeeJet Off-Center spray tips are commonly installed in double and single swivel nozzle bodies. Because these bodies are adjustable for angular position, a wide spray swath is easily obtained.

See page 71 for swivels and hose drops.

How to order:

Specify tip number and material.
Example: OC-02 – Brass
OC-SS06 – Stainless Steel

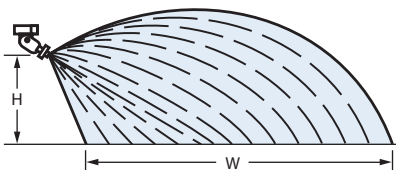

PSI	CAPACITY ONE NOZZLE IN GPM	HEIGHT = 18'						HEIGHT = 24'					
		"W" IN INCHES		GPA				"W" IN INCHES		GPA			
		3 MPH	4 MPH	5 MPH	6 MPH	6 MPH	6 MPH	3 MPH	4 MPH	5 MPH	6 MPH	6 MPH	6 MPH
OC-01 (100)	30	0.087	58	3.0	2.2	1.8	1.5	65	2.7	2.0	1.6	1.3	1.3
	40	0.10	60	3.3	2.5	2.0	1.7	67	3.0	2.2	1.8	1.5	1.5
	60	0.12	62	3.8	2.9	2.3	1.9	69	3.4	2.6	2.1	1.7	1.7
OC-02 (50)	30	0.17	68	5.0	3.7	3.0	2.5	75	4.5	3.4	2.7	2.2	2.2
	40	0.20	70	5.7	4.2	3.4	2.8	77	5.1	3.9	3.1	2.6	2.6
	60	0.24	72	6.6	5.0	4.0	3.3	78	6.1	4.6	3.7	3.0	3.0
OC-03 (50)	30	0.26	77	6.7	5.0	4.0	3.3	80	6.4	4.8	3.9	3.2	3.2
	40	0.30	80	7.4	5.6	4.5	3.7	83	7.2	5.4	4.3	3.6	3.6
	60	0.37	82	8.9	6.7	5.4	4.5	85	8.6	6.5	5.2	4.3	4.3
OC-04 (50)	30	0.35	91	7.6	5.7	4.6	3.8	93	7.5	5.6	4.5	3.7	3.7
	40	0.40	93	8.5	6.4	5.1	4.3	94	8.4	6.3	5.1	4.2	4.2
	60	0.49	94	10.3	7.7	6.2	5.2	95	10.2	7.7	6.1	5.1	5.1
OC-06 (50)	30	0.52	99	10.4	7.8	6.2	5.2	108	9.5	7.2	5.7	4.8	4.8
	40	0.60	101	11.8	8.8	7.1	5.9	110	10.8	8.1	6.5	5.4	5.4
	60	0.73	102	14.2	10.6	8.5	7.1	111	13.0	9.8	7.8	6.5	6.5
OC-08 (50)	30	0.69	100	13.7	10.2	8.2	6.8	110	12.4	9.3	7.5	6.2	6.2
	40	0.80	102	15.5	11.6	9.3	7.8	112	14.1	10.6	8.5	7.1	7.1
	60	0.98	104	18.7	14.0	11.2	9.3	113	17.2	12.9	10.3	8.6	8.6
OC-12	30	1.04	102	20	15.1	12.1	10.1	113	18.2	13.7	10.9	9.1	9.1
	40	1.20	104	23	17.1	13.7	11.4	115	21	15.5	12.4	10.3	10.3
	60	1.47	105	28	21	16.6	13.9	116	25	18.8	15.1	12.5	12.5
OC-16	30	1.39	132	21	15.6	12.5	10.4	142	19.4	14.5	11.6	9.7	9.7
	40	1.60	138	23	17.2	13.8	11.5	146	22	16.3	13.0	10.8	10.8
	60	1.96	143	27	20	16.3	13.6	148	26	19.7	15.7	13.1	13.1

Note: Always double check your application rates. Tabulations are based on spraying water at 70°F (21°C). See pages 136–157 for useful formulas and other information.



FullJet® Wide Angle Full Cone Spray Tips

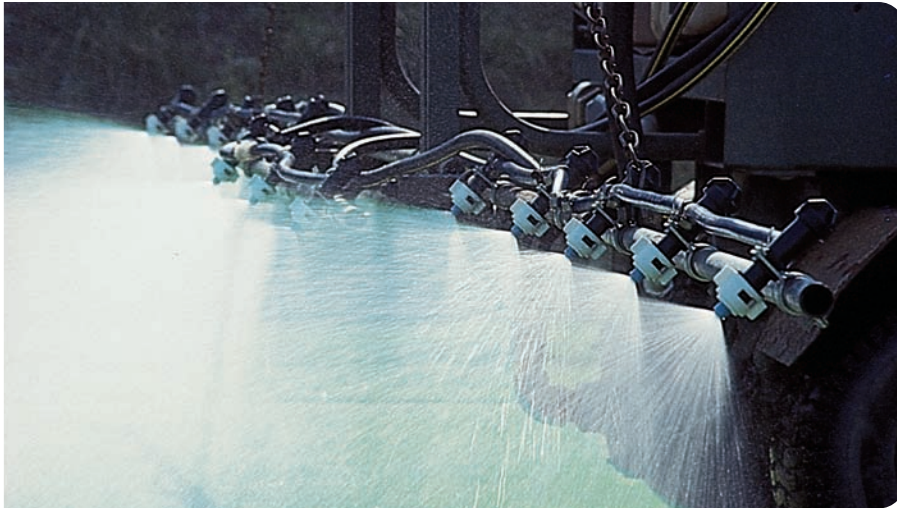

Features:

- Large droplets to reduce drift.
- Excellent spray distribution over a range of pressures 15–40 PSI (1–3 bar).
- Ideal for use on rigs with sprayer controllers.
- Wide spray angle allows use on 40" (100 cm) spacings.
- Available in VisiFlo® color-coding system in all stainless steel or Celcon® with stainless steel vane.
- Can be used with CP25607*-NY for Quick TeeJet® connection. Reference page 64 for more information.

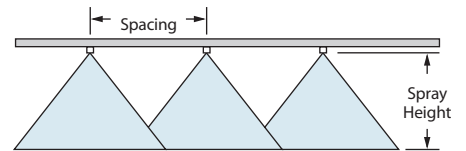

Optimum Spray Height

Tip Spacing	Optimum Spray Height
40"	20"*
30"	30"*
20"	39"*

FullJet nozzles should be angled 30°–45° from vertical for uniform spray distribution.

*Wide angle spray nozzle height is influenced by nozzle orientation. The critical factor is to achieve a minimum 30% overlap.

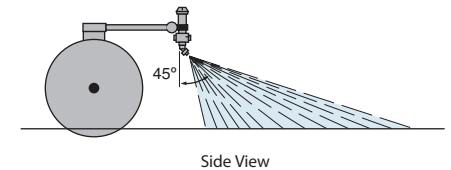

Nozzle	PSI	CAPACITY ONE NOZZLE IN GPM	CAPACITY ONE NOZZLE IN OZ./MIN.	40" Spacing								20" Spacing			
				GPA								GALLONS PER 1000 SQ. FT.			
				3 MPH	4 MPH	5 MPH	6 MPH	7 MPH	8 MPH	10 MPH	2 MPH	3 MPH	4 MPH	5 MPH	
FL-5	15	0.34	44	16.8	12.6	10.1	8.4	7.2	6.3	5.0	1.2	0.77	0.58	0.46	
	20	0.38	49	18.8	14.1	11.3	9.4	8.1	7.1	5.6	1.3	0.86	0.65	0.52	
	30	0.46	59	23	17.1	13.7	11.4	9.8	8.5	6.8	1.6	1.0	0.78	0.63	
	40	0.50	64	25	18.6	14.9	12.4	10.6	9.3	7.4	1.7	1.1	0.85	0.68	
FL-6.5	15	0.42	54	21	15.6	12.5	10.4	8.9	7.8	6.2	1.4	0.95	0.71	0.57	
	20	0.48	61	24	17.8	14.3	11.9	10.2	8.9	7.1	1.6	1.1	0.82	0.65	
	30	0.57	73	28	21	16.9	14.1	12.1	10.6	8.5	1.9	1.3	0.97	0.78	
	40	0.65	83	32	24	19.3	16.1	13.8	12.1	9.7	2.2	1.5	1.1	0.88	
FL-8	15	0.51	65	25	18.9	15.1	12.6	10.8	9.5	7.6	1.7	1.2	0.87	0.69	
	20	0.58	74	29	22	17.2	14.4	12.3	10.8	8.6	2.0	1.3	0.99	0.79	
	30	0.70	90	35	26	21	17.3	14.9	13.0	10.4	2.4	1.6	1.2	0.95	
	40	0.80	102	40	30	24	19.8	17.0	14.9	11.9	2.7	1.8	1.4	1.1	
FL-10	15	0.67	86	33	25	19.9	16.6	14.2	12.4	9.9	2.3	1.5	1.1	0.91	
	20	0.76	97	38	28	23	18.8	16.1	14.1	11.3	2.6	1.7	1.3	1.0	
	30	0.91	116	45	34	27	23	19.3	16.9	13.5	3.1	2.1	1.5	1.2	
	40	1.00	128	50	37	30	25	21	18.6	14.9	3.4	2.3	1.7	1.4	
FL-15	15	0.97	124	48	36	29	24	21	18.0	14.4	3.3	2.2	1.6	1.3	
	20	1.11	142	55	41	33	27	24	21	16	3.8	2.5	1.9	1.5	
	30	1.32	169	65	49	39	33	28	25	20	4.5	3.0	2.2	1.8	
	40	1.50	192	74	56	45	37	32	28	22	5.1	3.4	2.6	2.0	

Note: Always double check your application rates. Tabulations are based on spraying water at 70°F (21°C). See pages 136–157 for useful formulas and other information.

How to order:

Specify tip number.

Examples:

FL-5SVS – Stainless Steel with VisiFlo color-coding

FL-5VC – Celcon with Stainless Steel vane and VisiFlo color-coding

XP BoomJet® Boomless Flat Spray Nozzles



Typical Applications:

- Boomless field spray applications.
- Roadside and right-of-way applications.
- End row spraying.
- Orchard spraying.
- De-icing applications.
- Forestry.

Features:

- Unique orifice geometry produces a wide spray pattern while maintaining superior distribution across entire width.
- Pre-orifice design minimizes drift.
- Extra wide spray pattern—up to 18.5' (5.5 meters)—using a single nozzle.
- Removable polymer pre-orifice.
- Acetal construction for excellent chemical resistance.

- Recommended spray pressure range: 20–60 PSI (1.5–4 bar).
- NPT or BSPT (male) threads for easy installation.
- Color-coding for easy capacity identification.

Mounting Note: Position tip horizontal to ground with spray pattern down and to the side.

How to order:

Specify part number. Example:

(B)1/2XP80L(R)-VP – VisiFlo® Polymer Left Boom Spray

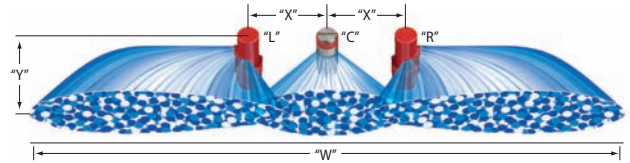

NOZZLE "R", "L"	CENTER NOZZLE "C"	PSI	DROP SIZE	CAPACITY THREE NOZZLES IN GPM	SPRAY WIDTH "W" (FEET)		HEIGHT "Y" = 24"										HEIGHT "Y" = 36"									
					24" HEIGHT	36" HEIGHT	GPA FOR THREE NOZZLES					GALLONS PER 1000 SQ. FT.					GPA FOR THREE NOZZLES					GALLONS PER 1000 SQ. FT.				
							4 MPH	6 MPH	8 MPH	10 MPH	15 MPH	20 MPH	2 MPH	3 MPH	4 MPH	5 MPH	4 MPH	6 MPH	8 MPH	10 MPH	15 MPH	20 MPH	2 MPH	3 MPH	4 MPH	5 MPH
					(B)1/4XP10R (B)1/4XP10L	1/4TTJ08	30	UC	2.43	23.3	25.3	12.9	8.6	6.5	5.2	3.4	2.6	0.59	0.39	0.30	0.24	11.9	7.9	5.9	4.8	3.2
40	UC	2.80	25.3	28.3			13.7	9.1	6.8	5.5	3.7	2.7	0.63	0.42	0.31	0.25	12.2	8.2	6.1	4.9	3.3	2.4	0.56	0.37	0.28	0.22
50	UC	3.13	28.3	30.3			13.7	9.1	6.8	5.5	3.6	2.7	0.66	0.42	0.31	0.25	12.8	8.5	6.4	5.1	3.4	2.6	0.59	0.39	0.29	0.23
60	UC	3.42	29.3	32.3			14.4	9.6	7.2	5.8	3.9	2.9	0.66	0.44	0.33	0.26	13.1	8.7	6.6	5.2	3.5	2.6	0.60	0.40	0.30	0.24
(B)1/4XP20R (B)1/4XP20L	1/4TTJ08	30	UC	4.19	26.3	27.3	19.7	13.1	9.9	7.9	5.3	3.9	0.90	0.60	0.45	0.36	19.0	12.7	9.5	7.6	5.1	3.8	0.87	0.58	0.43	0.35
		40	UC	4.80	30.3	31.3	19.6	13.1	9.8	7.8	5.2	3.9	0.90	0.60	0.45	0.36	19.0	12.7	9.5	7.6	5.1	3.8	0.87	0.58	0.43	0.35
		50	UC	5.39	32.3	33.3	21	13.8	10.3	8.3	5.5	4.1	0.95	0.63	0.47	0.38	20	13.4	10.0	8.0	5.3	4.0	0.92	0.61	0.46	0.37
		60	UC	5.98	33.3	35.3	22	14.8	11.1	8.9	5.9	4.4	1.0	0.68	0.51	0.41	21	14.0	10.5	8.4	5.6	4.2	0.96	0.64	0.48	0.38
(B)1/4XP25R (B)1/4XP25L	1/4TTJ10	30	UC	5.13	27.3	30.3	23	15.5	11.6	9.3	6.2	4.7	1.1	0.71	0.53	0.43	21	14.0	10.5	8.4	5.6	4.2	0.96	0.64	0.48	0.38
		40	UC	6.00	30.3	32.3	25	16.3	12.3	9.8	6.5	4.9	1.1	0.75	0.56	0.45	23	15.3	11.5	9.2	6.1	4.6	1.1	0.70	0.53	0.42
		50	UC	6.62	32.3	33.3	25	16.9	12.7	10.1	6.8	5.1	1.2	0.77	0.58	0.46	25	16.4	12.3	9.8	6.6	4.9	1.1	0.75	0.56	0.45
		60	UC	7.22	33.3	35.3	27	17.9	13.4	10.7	7.2	5.4	1.2	0.82	0.61	0.49	25	16.9	12.7	10.1	6.7	5.1	1.2	0.77	0.58	0.46
(B)1/2XP40R (B)1/2XP40L	1/4TTJ15	30	UC	8.36	29.3	32.3	35	24	17.7	14.1	9.4	7.1	1.6	1.1	0.81	0.65	32	21	16.0	12.8	8.5	6.4	1.5	0.98	0.73	0.59
		40	UC	9.50	31.3	34.3	38	25	18.8	15.0	10.0	7.5	1.7	1.1	0.86	0.69	34	23	17.1	13.7	9.1	6.9	1.6	1.0	0.78	0.63
		50	UC	10.8	33.3	35.3	40	27	20	16.1	10.7	8.0	1.8	1.2	0.92	0.74	38	25	18.9	15.1	10.1	7.6	1.7	1.2	0.87	0.69
		60	UC	11.8	35.3	38.3	41	28	21	16.5	11.0	8.3	1.9	1.3	0.95	0.76	38	25	19.1	15.3	10.2	7.6	1.7	1.2	0.87	0.70

Note: Always double check your application rates. Tabulations are based on spraying water at 70°F (21°C). See pages 136–157 for drop size classification, useful formulas and other information.
For lower chart only, application rates are identical for a two-tip setup. Swath width and flow capacity will be doubled for a two-tip setup.

(B)=BSPT

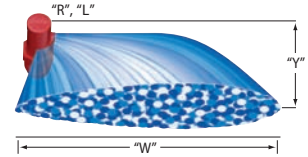

NOZZLE "R", "L"	PSI	DROP SIZE	CAPACITY ONE NOZZLE IN GPM	SPRAY WIDTH "W" (FEET)		HEIGHT "Y" = 24"										HEIGHT "Y" = 36"									
				24" HEIGHT	36" HEIGHT	GPA FOR ONE NOZZLE					GALLONS PER 1000 SQ. FT.					GPA FOR ONE NOZZLE					GALLONS PER 1000 SQ. FT.				
						4 MPH	6 MPH	8 MPH	10 MPH	15 MPH	20 MPH	2 MPH	3 MPH	4 MPH	5 MPH	4 MPH	6 MPH	8 MPH	10 MPH	15 MPH	20 MPH	2 MPH	3 MPH	4 MPH	5 MPH
(B)1/4XP10R (B)1/4XP10L	20	UC	0.71	8.5	10.0	10.3	6.9	5.2	4.1	2.8	2.1	0.47	0.32	0.24	0.19	8.8	5.9	4.4	3.5	2.3	1.8	0.40	0.27	0.20	0.16
	30	UC	0.87	10.0	11.0	10.8	7.2	5.4	4.3	2.9	2.2	0.49	0.33	0.25	0.20	9.8	6.5	4.9	3.9	2.6	2.0	0.45	0.30	0.22	0.18
	40	UC	1.00	11.0	12.5	11.3	7.5	5.6	4.5	3.0	2.3	0.52	0.34	0.26	0.21	9.9	6.6	5.0	4.0	2.6	2.0	0.45	0.30	0.23	0.18
	50	UC	1.12	12.5	13.5	11.1	7.4	5.5	4.4	3.0	2.2	0.51	0.34	0.25	0.20	10.3	6.8	5.1	4.1	2.7	2.1	0.47	0.31	0.24	0.19
(B)1/4XP20R (B)1/4XP20L	20	UC	1.22	13.0	14.5	11.6	7.7	5.8	4.6	3.1	2.3	0.53	0.35	0.27	0.21	10.4	6.9	5.2	4.2	2.8	2.1	0.48	0.32	0.24	0.19
	30	UC	1.42	9.0	11.0	19.5	13.0	9.8	7.8	5.2	3.9	0.89	0.60	0.45	0.36	16.0	10.7	8.0	6.4	4.3	3.2	0.73	0.49	0.37	0.29
	40	UC	1.75	11.5	12.0	18.8	12.6	9.4	7.5	5.0	3.8	0.86	0.57	0.43	0.34	18.0	12.0	9.0	7.2	4.8	3.6	0.83	0.55	0.41	0.33
	50	UC	2.25	14.5	15.0	19.2	12.8	9.6	7.7	5.1	3.8	0.88	0.59	0.44	0.35	18.6	12.4	9.3	7.4	5.0	3.7	0.85	0.57	0.43	0.34
(B)1/4XP25R (B)1/4XP25L	20	UC	2.50	15.0	16.0	21	13.8	10.3	8.3	5.5	4.1	0.94	0.63	0.47	0.38	19.3	12.9	9.7	7.7	5.2	3.9	0.89	0.59	0.44	0.35
	30	UC	1.74	10.5	11.0	21	13.7	10.3	8.2	5.5	4.1	0.94	0.63	0.47	0.38	19.6	13.1	9.8	7.8	5.2	3.9	0.90	0.60	0.45	0.36
	40	UC	2.13	12.0	13.5	22	14.6	11.0	8.8	5.9	4.4	1.0	0.67	0.50	0.40	19.5	13.0	9.8	7.8	5.2	3.9	0.89	0.60	0.45	0.36
	50	UC	2.50	13.5	14.5	23	15.3	11.5	9.2	6.1	4.6	1.0	0.70	0.52	0.42	21	14.2	10.7	8.5	5.7	4.3	0.98	0.65	0.49	0.39
(B)1/2XP40R (B)1/2XP40L	20	UC	2.75	14.5	15.0	23	15.6	11.7	9.4	6.3	4.7	1.1	0.72	0.54	0.43	23	15.1	11.3	9.1	6.1	4.5	1.0	0.69	0.52	0.42
	30	UC	3.00	15.0	16.0	25	16.5	12.4	9.9	6.6	5.0	1.1	0.76	0.57	0.45	23	15.5	11.6	9.3	6.2	4.6	1.1	0.71	0.53	0.43
	40	UC	2.87	11.0	12.0	32	16.2	12.1	9.9	6.6	5.5	1.5	0.99	0.74	0.59	30	19.7	14.8	11.8	7.9	5.9	1.4	0.90	0.68	0.54
	50	UC	3.53	13.0	14.5	34	22	16.8	13.4	9.0	6.7	1.5	1.0	0.77	0.62	30	20	15.1	12.1	8.0	6.0	1.4	0.92	0.69	0.55
(B)1/2XP80R (B)1/2XP80L	20	UC	4.00	14.0	15.5	35	24	17.7	14.1	9.4	7.1	1.6	1.1	0.81	0.65	32	21	16.0	12.8	8.5	6.4	1.5	0.97	0.73	0.58
	30	UC	4.55	15.0	16.0	38	25	18.8	15.0	10.0	7.5	1.7	1.1	0.86	0.69	35	23	17.6	14.1	9.4	7.0	1.6	1.1	0.81	0.64
	40	UC	5.00	16.0	17.5	39	26	19.3	15.5	10.3	7.7	1.8	1.2	0.89	0.71	35	24	17.7	14.1	9.4	7.1	1.6	1.1	0.81	0.65
	60	UC	5.60	13.0	15.5	53	36	27	21	14.2	10.7	2.4	1.6	1.2	0.98	45	30	22.7	17.9	11.9	8.9	2.0	1.4	1.0	0.82
(B)1/2XP80R (B)1/2XP80L	30	UC	6.83	15.0	16.5	56	38	28	23	15.0	11.3	2.6	1.7	1.3	1.0	51	34	26	20	13.7	10.2	2.3	1.6	1.2	0.94
	40	UC	8.00	16.0	17.5	62	41	31	25	16.5	12.4	2.8	1.9	1.4	1.1	57	38	28	23	15.1	11.3	2.6	1.7	1.3	1.0
	50	UC	8.73	16.5	18.0	65	44	33	26	17.5	13.1	3.0	2.0	1.5	1.2	60	40	30	24	16.0	12.0	2.7	1.8	1.4	1.1
	60	UC	9.60	17.5	18.5	68	45	34	27	18.1	13.6	3.1	2.1	1.6	1.2	64	43	32	26	17.1	12.8	2.9	2.0	1.5	1.2



BoomJet® Boomless Nozzles with Extra-Wide Flat Spray Projection

5430-3/4 NPT



5880-3/4 NPT Female Back inlet connection.



The 5430 and 5880 BoomJet nozzles are used for spraying areas not easily accessed with a boom sprayer. They combine two off-center tips and three VeeJet® nozzles to produce a wide swath flat spray. While not as uniform as a boom sprayer, the BoomJet provides good distribution.* The 5880 features a 1/4" gauge port and is supplied with one additional 1/4" NPT pipe plug and one blank tip for spraying to one side only. The 5430 utilizes a swivel design which can be adjusted to modify the spray pattern width. Both models feature 3/4" NPT female inlet threads.

*Uniformity can be optimized by double overlapping spray swaths on successive sprayer passes. Remember, this also doubles the application volume.

How to order:

Specify BoomJet nozzle number.
Example: 5880-3/4-2TOC-06

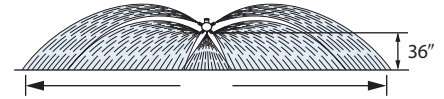

W = Maximum effective coverage with nozzle mounted at 36" height.

Image	(2)	Image (2)	Image (1)	PSI	GPM	"W" (FEET)	GPA					GALLONS PER 1000 SQ. FT.			
							4 MPH	5 MPH	7.5 MPH	10 MPH	15 MPH	2 MPH	3 MPH	4 MPH	5 MPH
5430-3/4-2TOC06 5880-3/4-2TOC06	6733-OC06	H1/4VW-1506	H1/4VVL-9502 with 50 mesh strainer	20	1.84	33.5	6.8	5.4	3.6	2.7	1.8	0.31	0.21	0.16	0.12
				30	2.25	34	8.2	6.6	4.4	3.3	2.2	0.38	0.25	0.19	0.15
				40	2.60	34.5	9.3	7.5	5.0	3.7	2.5	0.43	0.28	0.21	0.17
5430-3/4-2TOC10 5880-3/4-2TOC10	OC-10	H1/4U-0508HE	H1/4VVL-11004 with 50 mesh strainer	20	2.83	39.5	8.9	7.1	4.7	3.5	2.4	0.41	0.27	0.20	0.16
				30	3.46	40	10.7	8.6	5.7	4.3	2.9	0.49	0.33	0.25	0.20
				40	4.00	40.5	12.2	9.8	6.5	4.9	3.3	0.56	0.37	0.28	0.22
5430-3/4-2TOC20 5880-3/4-2TOC20	OC-20	H1/4U-0520HE	H1/4VVL-9506 with 50 mesh strainer	20	6.08	47	16.0	12.8	8.5	6.4	4.3	0.73	0.49	0.37	0.29
				30	7.45	50	18.4	14.8	9.8	7.4	4.9	0.84	0.56	0.42	0.34
				40	8.60	52	20	16.4	10.9	8.2	5.5	0.94	0.62	0.47	0.37
5430-3/4-2TOC40 5880-3/4-2TOC40	OC-40	H1/4U-0540HE	H1/4U-9510	20	12.0	56	27	21	14.1	10.6	7.1	1.2	0.81	0.61	0.49
				30	14.7	60	30	24	16.2	12.1	8.1	1.4	0.93	0.69	0.56
				40	17.0	63	33	27	17.8	13.4	8.9	1.5	1.0	0.76	0.61

Note: Always double check your application rates. Tabulations are based on spraying water at 70°F (21°C). See pages 136-157 for useful formulas and other information.



TeeJet® Swivel Spray Nozzles with Off-Center Flat Spray Tips — Larger Capacities

Large capacity swivel nozzles, available in both single or double styles, are available with 3/4" NPT (F) inlet connections for use as boomless type nozzles. For double swivels the tabulated GPM (l/min) capacities are twice those shown for single swivels.

How to order:

Specify swivel number and material.
Example: 4629-3/4-TOC10 Brass

Extra Wide Flat Spray Coverage

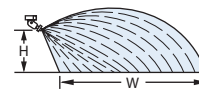

W = Maximum effective coverage with nozzle mounted at 36" height.



Type 4629-3/4-TOC Single Swivel with 3/4" NPT (F) pipe connection. Brass.

Type 4418-3/4-2TOC Double Swivel with 3/4" NPT (F) pipe connection. Brass.



Image	PSI	GPM	"W" (FEET)	HEIGHT = 36"		
				GPA		
				5 MPH	10 MPH	15 MPH
4629-3/4-TOC10	30	0.87	18	4.8	2.4	1.6
	40	1.00	18.5	5.4	2.7	1.8
	60	1.22	18.5	6.5	3.3	2.2
4629-3/4-TOC20	30	1.73	23.5	7.3	3.6	2.4
	40	2.00	24.5	8.1	4.0	2.7
	60	2.45	24.5	9.9	5.0	3.3
4629-3/4-TOC40	30	3.46	26	13.2	6.6	4.4
	40	4.00	27	14.7	7.3	4.9
	60	4.90	27	18.0	9.0	6.0
4629-3/4-TOC80	30	6.93	29	24	11.8	7.9
	40	8.00	30	26	13.2	8.8
	60	9.80	30	32	16.2	10.8
4629-3/4-TOC150	30	13.0	30.5	42	21	14.1
	40	15.0	31.5	47	24	15.7
	60	18.4	31.5	58	29	19.3
4629-3/4-TOC300	30	26.0	32	80	40	27
	40	30.0	33	90	45	30
	60	36.7	33.5	108	54	36

Note: Always double check your application rates. Tabulations are based on spraying water at 70°F (21°C). See pages 136-157 for useful formulas and other information.

FieldJet® Boomless Nozzles with Extra-Wide Flat Spray Projection



Type 1/4-KLC
1/4" NPT male pipe connections



The KLC FieldJet nozzle is typically used to spray areas not accessible with a boom sprayer. Its one-piece nozzle design projects spray to both sides to form a wide swath flat spray. The round orifice minimizes clogging. Uniformity across the swath is not as good as with a properly operated boom sprayer.* Available in brass or stainless steel.

*Uniformity can be optimized by double overlapping spray swaths on successive sprayer passes. Remember, this also doubles the application volume.

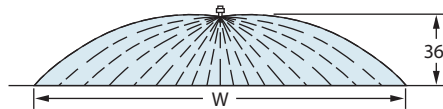

How to order:

Specify part number and material.

Example: 1/4KLC-SS18 – Stainless Steel

Nozzle Type	PSI	CAPACITY ONE NOZZLE IN GPM	"W" IN FEET	GPA				GALLONS PER 1000 SQ. FT.			
				3 MPH	4 MPH	5 MPH	8 MPH	3 MPH	4 MPH	5 MPH	8 MPH
1/4-KLC-5	20	0.71	17	6.9	5.2	4.1	2.6	.16	.12	.09	.06
	30	0.87	18	8.0	6.0	4.8	3.0	.18	.14	.11	.07
	40	1.00	21	7.9	5.9	4.7	2.9	.18	.13	.11	.07
1/4-KLC-9	20	1.27	18	11.6	8.7	7.0	4.4	.27	.20	.16	.10
	30	1.56	19	13.5	10.2	8.1	5.1	.31	.23	.19	.12
	40	1.80	21	14.1	10.6	8.5	5.3	.32	.24	.19	.12
1/4-KLC-18	20	2.55	20	21	15.8	12.6	7.9	.48	.36	.29	.18
	30	3.12	21	25	18.4	14.7	9.2	.56	.42	.34	.21
	40	3.60	22	27	20	16.2	10.1	.62	.46	.37	.23
1/4-KLC-36	20	5.09	22	38	29	23	14.3	.87	.66	.52	.33
	30	6.24	24	43	32	26	16.1	.98	.74	.59	.37
	40	7.20	26	46	34	27	17.1	1.0	.78	.63	.39

Note: Always double check your application rates. Tabulations are based on spraying water at 70°F (21°C). See pages 136–157 for useful formulas and other information.



ConeJet® VisiFlo® Hollow Cone Spray Tips

Typical Applications:

See selection guide on page 5 for recommended typical applications for ConeJet tips.

Features:

- VisiFlo color-coded versions consist of stainless steel or ceramic orifice in a polypropylene body. Maximum operating pressure 300 PSI (20 bar). Spray angle is 80° at 100 PSI (7 bar).
- Ideal for banding with two or three nozzles over the row.
- Finely atomized spray pattern provides thorough coverage.
- Standard ConeJet (not color-coded) available in brass and stainless steel in a wide range of capacities with 65° (TY) and 80° (TX) spray angles.

How to order:

Specify tip number.

Examples:

- TX-VS4 – Stainless Steel with VisiFlo color-coding
- TX-4 – Brass
- TX-SS4 – Stainless Steel
- TX-VK4 – Ceramic with VisiFlo color-coding

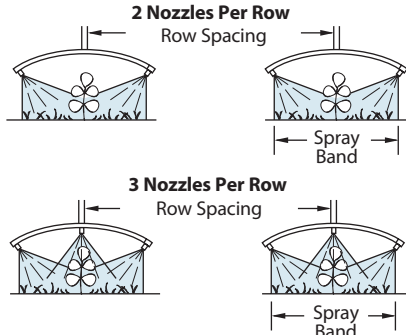

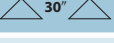
	GPA CONVERSION FACTORS*
	
8"	3.75
10"	3.00
12"	2.50
15"	2.00

*To find GPA rate on band widths, multiply the tabulated GPA for ROW SPACING by the conversion factors.

See pages 136–157 for useful formulas and other information.

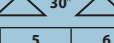
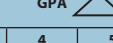

	PSI	DROP SIZE	CAPACITY TWO NOZZLES IN GPM	CAPACITY TWO NOZZLES IN OZ./MIN.	GPA 					PSI	CAPACITY THREE NOZZLES IN GPM	CAPACITY THREE NOZZLES IN OZ./MIN.	GPA 				
					3 MPH	4 MPH	5 MPH	6 MPH	7 MPH				3 MPH	4 MPH	5 MPH	6 MPH	7 MPH
TX-1	40	VF	0.033	4.2	2.2	1.6	1.3	1.1	0.93	40	0.050	6.4	3.3	2.5	2.0	1.7	1.4
	60	VF	0.039	5.0	2.6	1.9	1.5	1.3	1.1	60	0.059	7.6	3.9	2.9	2.3	1.9	1.7
	75	VF	0.043	5.5	2.8	2.1	1.7	1.4	1.2	75	0.065	8.3	4.3	3.2	2.6	2.1	1.8
	90	VF	0.047	6.0	3.1	2.3	1.9	1.6	1.3	90	0.070	9.0	4.6	3.5	2.8	2.3	2.0
TX-2	40	VF	0.067	8.6	4.4	3.3	2.7	2.2	1.9	40	0.100	13	6.6	5.0	4.0	3.3	2.8
	60	VF	0.080	10	5.3	4.0	3.2	2.6	2.3	60	0.12	15	7.9	5.9	4.8	4.0	3.4
	75	VF	0.088	11	5.8	4.4	3.5	2.9	2.5	75	0.13	17	8.6	6.4	5.1	4.3	3.7
	90	VF	0.095	12	6.3	4.7	3.8	3.1	2.7	90	0.14	18	9.2	6.9	5.5	4.6	4.0
TX-3	40	VF	0.10	13	6.6	5.0	4.0	3.3	2.8	40	0.15	19	9.9	7.4	5.9	5.0	4.2
	60	VF	0.12	15	7.9	5.9	4.8	4.0	3.4	60	0.18	23	11.9	8.9	7.1	5.9	5.1
	75	VF	0.13	17	8.6	6.4	5.1	4.3	3.7	75	0.20	26	13.2	9.9	7.9	6.6	5.7
	90	VF	0.14	18	9.2	6.9	5.5	4.6	4.0	90	0.21	27	13.9	10.4	8.3	6.9	5.9
TX-4	40	VF	0.13	17	8.6	6.4	5.1	4.3	3.7	40	0.20	26	13.2	9.9	7.9	6.6	5.7
	60	VF	0.16	20	10.6	7.9	6.3	5.3	4.5	60	0.24	31	15.8	11.9	9.5	7.9	6.8
	75	VF	0.18	23	11.9	8.9	7.1	5.9	5.1	75	0.27	35	17.8	13.4	10.7	8.9	7.6
	90	VF	0.19	24	12.5	9.4	7.5	6.3	5.4	90	0.29	37	19.1	14.4	11.5	9.6	8.2
TX-6	40	F	0.20	26	13.2	9.9	7.9	6.6	5.7	40	0.30	38	19.8	14.9	11.9	9.9	8.5
	60	VF	0.24	31	15.8	11.9	9.5	7.9	6.8	60	0.36	46	24	17.8	14.3	11.9	10.2
	75	VF	0.27	35	17.8	13.4	10.7	8.9	7.6	75	0.40	51	26	19.8	15.8	13.2	11.3
	90	VF	0.29	37	19.1	14.4	11.5	9.6	8.2	90	0.43	55	28	21	17.0	14.2	12.2
TX-8	40	F	0.27	35	17.8	13.4	10.7	8.9	7.6	40	0.40	51	26	19.8	15.8	13.2	11.3
	60	VF	0.32	41	21	15.8	12.7	10.6	9.1	60	0.49	63	32	24	19.4	16.2	13.9
	75	VF	0.36	46	24	17.8	14.3	11.9	10.2	75	0.54	69	36	27	21	17.8	15.3
	90	VF	0.39	50	26	19.3	15.4	12.9	11.0	90	0.59	76	39	29	23	19.5	16.7
TX-10	40	F	0.33	42	22	16.3	13.1	10.9	9.3	40	0.50	64	33	25	19.8	16.5	14.1
	60	F	0.40	51	26	19.8	15.8	13.2	11.3	60	0.61	78	40	30	24	20	17.3
	75	VF	0.45	58	30	22	17.8	14.9	12.7	75	0.68	87	45	34	27	22	19.2
	90	VF	0.49	63	32	24	19.4	16.2	13.9	90	0.74	95	49	37	29	24	21
TX-12	40	F	0.40	51	26	19.8	15.8	13.2	11.3	40	0.60	77	40	30	24	19.8	17.0
	60	F	0.49	63	32	24	19.4	16.2	13.9	60	0.73	93	48	36	29	24	21
	75	VF	0.54	69	36	27	21	17.8	15.3	75	0.81	104	53	40	32	27	23
	90	VF	0.59	76	39	29	23	19.5	16.7	90	0.88	113	58	44	35	29	25
TX-18	40	F	0.60	77	40	30	24	19.8	17.0	40	0.90	115	59	45	36	30	25
	60	F	0.73	93	48	36	29	24	21	60	1.10	141	73	54	44	36	31
	75	F	0.82	105	54	41	32	27	23	75	1.23	157	81	61	49	41	35
	90	VF	0.90	115	59	45	36	30	25	90	1.35	173	89	67	53	45	38
TX-26	40	F	0.87	111	57	43	34	29	25	40	1.30	166	86	64	51	43	37
	60	F	1.06	136	70	52	42	35	30	60	1.59	204	105	79	63	52	45
	75	F	1.18	151	78	58	47	39	33	75	1.78	228	117	88	70	59	50
	90	VF	1.30	166	86	64	51	43	37	90	1.94	248	128	96	77	64	55
120	VF	1.49	191	98	74	59	49	42	120	2.24	287	148	111	89	74	63	

Note: Always double check your application rates. Tabulations are based on spraying water at 70°F (21°C).

†Specify material.

AI TeeJet® Air Induction Even Flat Spray Tips



Typical Applications:

See selection guide on page 5 for recommended typical applications for AI TeeJet tips.

Features:

- Available with stainless steel insert, polymer holder and pre-orifice with VisiFlo® color-coding.
- Larger droplets for less drift.
- Depending on the chemical, produces large air-filled drops through the use of a Venturi air aspirator.
- Ideal for banding over the row or in row middles.
- Automatic spray alignment with 25598*-NYR Quick TeeJet® cap and gasket. Reference page 64 for more information.



Note: Due to the pre-orifice design, this tip is not compatible with the 4193A check valve tip strainer.

Tip #	PSI	DROPSIZE	CAPACITY ONE NOZZLE IN GPM	CAPACITY ONE NOZZLE IN OZ./MIN.	GPA @ 30° Field Acres												
					3 MPH	3.5 MPH	4 MPH	4.5 MPH	5 MPH	5.5 MPH	6 MPH	6.5 MPH	7 MPH	7.5 MPH	8 MPH	8.5 MPH	
AI9501SEVS (100)	30 UC	0.13	17	8.6	7.4	6.4	5.7	5.1	4.7	4.3	4.0	3.7	3.4	3.2	3.0		
	40 XC	0.15	19	9.9	8.5	7.4	6.6	5.9	5.4	5.0	4.6	4.2	4.0	3.7	3.5		
	50 XC	0.17	22	11.2	9.6	8.4	7.5	6.7	6.1	5.6	5.2	4.8	4.5	4.2	4.0		
	60 VC	0.18	23	11.9	10.2	8.9	7.9	7.1	6.5	5.9	5.5	5.1	4.8	4.5	4.2		
	70 VC	0.20	26	13.2	11.3	9.9	8.8	7.9	7.2	6.6	6.1	5.7	5.3	5.0	4.7		
	80 VC	0.21	27	13.9	11.9	10.4	9.2	8.3	7.6	6.9	6.4	5.9	5.5	5.2	4.9		
90 VC	0.23	29	15.2	13.0	11.4	10.1	9.1	8.3	7.6	7.0	6.5	6.1	5.7	5.4			
100 C	0.24	31	15.8	13.6	11.9	10.6	9.5	8.6	7.9	7.3	6.8	6.3	5.9	5.6			
AI9502SEVS (50)	30 UC	0.17	22	11.2	9.6	8.4	7.5	6.7	6.1	5.6	5.2	4.8	4.5	4.2	4.0		
	40 XC	0.20	26	13.2	11.3	9.9	8.8	7.9	7.2	6.6	6.1	5.7	5.3	5.0	4.7		
	50 XC	0.22	28	14.5	12.4	10.9	9.7	8.7	7.9	7.3	6.7	6.2	5.8	5.4	5.1		
	60 VC	0.24	31	15.8	13.6	11.9	10.6	9.5	8.6	7.9	7.3	6.8	6.3	5.9	5.6		
	70 VC	0.26	33	17.2	14.7	12.9	11.4	10.3	9.4	8.6	7.9	7.4	6.9	6.4	6.1		
	80 VC	0.28	36	18.5	15.8	13.9	12.3	11.1	10.1	9.2	8.5	7.9	7.4	6.9	6.5		
90 VC	0.30	38	19.8	17.0	14.9	13.2	11.9	10.8	9.9	9.1	8.5	7.9	7.4	7.0			
100 C	0.32	41	21	18.1	15.8	14.1	12.7	11.5	10.6	9.7	9.1	8.4	7.9	7.5			
AI9502SEVS (50)	30 UC	0.22	28	14.5	12.4	10.9	9.7	8.7	7.9	7.3	6.7	6.2	5.8	5.4	5.1		
	40 XC	0.25	32	16.5	14.1	12.4	11.0	9.9	9.0	8.3	7.6	7.1	6.6	6.2	5.8		
	50 XC	0.28	36	18.5	15.8	13.9	12.3	11.1	10.1	9.2	8.5	7.9	7.4	6.9	6.5		
	60 VC	0.31	40	20	17.5	15.3	13.6	12.3	11.2	10.2	9.4	8.8	8.2	7.7	7.2		
	70 VC	0.33	42	22	18.7	16.3	14.5	13.1	11.9	10.9	10.1	9.3	8.7	8.2	7.7		
	80 VC	0.35	45	23	19.8	17.3	15.4	13.9	12.6	11.6	10.7	9.9	9.2	8.7	8.2		
90 VC	0.38	49	25	21	18.8	16.7	15.0	13.7	12.5	11.6	10.7	10.0	9.4	8.9			
100 C	0.40	51	26	23	19.8	17.6	15.8	14.4	13.2	12.2	11.3	10.6	9.9	9.3			
AI9503SEVS (50)	30 UC	0.26	33	17.2	14.7	12.9	11.4	10.3	9.4	8.6	7.9	7.4	6.9	6.4	6.1		
	40 XC	0.30	38	19.8	17.0	14.9	13.2	11.9	10.8	9.9	9.1	8.5	7.9	7.4	7.0		
	50 XC	0.34	44	22	19.2	16.8	15.0	13.5	12.2	11.2	10.4	9.6	9.0	8.4	7.9		
	60 VC	0.37	47	24	21	18.3	16.3	14.7	13.3	12.2	11.3	10.5	9.8	9.2	8.6		
	70 VC	0.40	51	26	23	19.8	17.6	15.8	14.4	13.2	12.2	11.3	10.6	9.9	9.3		
	80 VC	0.42	54	28	24	21	18.5	16.6	15.1	13.9	12.8	11.9	11.1	10.4	9.8		
90 VC	0.45	58	30	25	22	19.8	17.8	16.2	14.9	13.7	12.7	11.9	11.1	10.5			
100 C	0.47	60	31	27	23	21	18.6	16.9	15.5	14.3	13.3	12.4	11.6	10.9			
AI9504SEVS (50)	30 UC	0.35	45	23	19.8	17.3	15.4	13.9	12.6	11.6	10.7	9.9	9.2	8.7	8.2		
	40 XC	0.40	51	26	23	19.8	17.6	15.8	14.4	13.2	12.2	11.3	10.6	9.9	9.3		
	50 XC	0.45	58	30	25	22	19.8	17.8	16.2	14.9	13.7	12.7	11.9	11.1	10.5		
	60 VC	0.49	63	32	28	24	22	19.4	17.6	16.2	14.9	13.9	12.9	12.1	11.4		
	70 VC	0.53	68	35	30	26	23	21	19.1	17.5	16.1	15.0	14.0	13.1	12.3		
	80 VC	0.57	73	38	32	28	25	23	21	18.8	17.4	16.1	15.0	14.1	13.3		
90 VC	0.60	77	40	34	30	26	24	22	19.8	18.3	17.0	15.8	14.9	14.0			
100 C	0.63	81	42	36	31	28	25	23	21	19.2	17.8	16.6	15.6	14.7			
AI9505SEVS (50)	30 UC	0.43	55	28	24	21	18.9	17.0	15.5	14.2	13.1	12.2	11.4	10.6	10.0		
	40 XC	0.50	64	33	28	25	22	19.8	18.0	16.5	15.2	14.1	13.2	12.4	11.6		
	50 XC	0.56	72	37	32	28	25	22	20	18.5	17.1	15.8	14.8	13.9	13.0		
	60 VC	0.61	78	40	35	30	27	24	22	20	18.6	17.3	16.1	15.1	14.2		
	70 VC	0.66	84	44	37	33	29	26	24	22	20	18.7	17.4	16.3	15.4		
	80 VC	0.71	91	47	40	35	31	28	26	23	22	20	18.7	17.6	16.5		
90 VC	0.75	96	50	42	37	33	30	27	25	23	21	19.8	18.6	17.5			
100 VC	0.79	101	52	45	39	35	31	28	26	24	22	21	19.6	18.4			
AI9506SEVS (50)	30 UC	0.52	67	34	29	26	23	21	18.7	17.2	15.8	14.7	13.7	12.9	12.1		
	40 UC	0.60	77	40	34	30	26	24	22	19.8	18.3	17.0	15.8	14.9	14.0		
	50 XC	0.67	86	44	38	33	29	27	24	22	20	19.0	17.7	16.6	15.6		
	60 VC	0.73	93	48	41	36	32	29	26	24	22	21	19.3	18.1	17.0		
	70 VC	0.79	101	52	45	39	35	31	28	26	24	22	21	19.6	18.4		
	80 VC	0.85	109	56	48	42	37	34	31	28	26	24	22	21	19.8		
90 VC	0.90	115	59	51	45	40	36	32	30	27	25	24	22	21			
100 VC	0.95	122	63	54	47	42	38	34	31	29	27	25	24	22			
AI9508SEVS (50)	30 UC	0.69	88	46	39	34	30	27	25	23	21	19.5	18.2	17.1	16.1		
	40 UC	0.80	102	53	45	40	35	32	29	26	24	23	21	19.8	18.6		
	50 XC	0.89	114	59	50	44	39	35	32	29	27	25	23	22	21		
	60 XC	0.98	125	65	55	49	43	39	35	32	30	28	26	24	23		
	70 XC	1.06	136	70	60	52	47	42	38	35	32	30	28	26	25		
	80 VC	1.13	145	75	64	56	50	45	41	37	34	32	30	28	26		
90 VC	1.20	154	79	68	59	53	48	43	40	37	34	32	30	28			
100 VC	1.26	161	83	71	62	55	50	45	42	38	36	33	31	29			

CONTACT PRODUCT	SYSTEMIC PRODUCT	DRIFT MANAGEMENT
GOOD	EXCELLENT	EXCELLENT

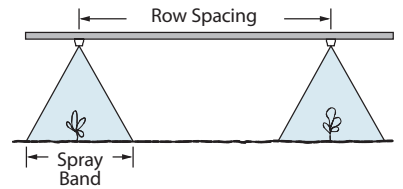

Band Width	Angle	GPA CONVERSION FACTORS*	
		20°	30°
8"	4°	2.50	3.75
10"	5°	2.00	3.00
12"	5°	1.67	2.50
15"	7°	1.33	2.00

*To find GPA rate on band widths, multiply the tabulated GPA for ROW SPACING by conversion factors.

How to order:

Specify tip number.

Example:

AI9504SEVS – Stainless Steel with VisiFlo color-coding

Note: Always double check your application rates. Tabulations are based on spraying water at 70°F (21°C). See pages 136–157 for drop size classification, useful formulas and other information.



DG TeeJet® Drift Guard Even Flat Spray Tips

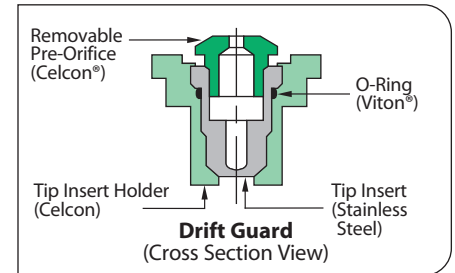

Note: Due to the pre-orifice design, this tip is not compatible with the 4193A check valve.

Typical Applications:

Can be used for pre-emerge surface-applied herbicides or post-emerge systemic herbicide applications.

Features:

- Pre-orifice design produces large droplets to reduce drift.
- Ideal for banding over the row or in row middles.
- Provides uniform distribution throughout the flat spray pattern.
- Easily mounted on spray boom or planter.
- Stainless steel with VisiFlo® color-coding.

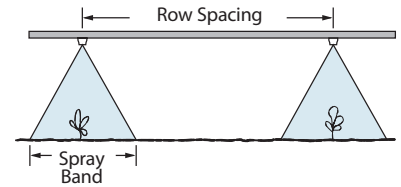

PSI	DROP SIZE	CAPACITY ONE NOZZLE IN GPM	CAPACITY ONE NOZZLE IN OZ./MIN.	GPA \triangle 30' \triangle Field Acres											
				3 MPH	3.5 MPH	4 MPH	4.5 MPH	5 MPH	5.5 MPH	6 MPH	6.5 MPH	7 MPH	7.5 MPH	8 MPH	8.5 MPH
30	M	0.13	17	8.6	7.4	6.4	5.7	5.1	4.7	4.3	4.0	3.7	3.4	3.2	3.0
	M	0.15	19	9.9	8.5	7.4	6.6	5.9	5.4	5.0	4.6	4.2	4.0	3.7	3.5
	F	0.17	22	11.2	9.6	8.4	7.5	6.7	6.1	5.6	5.2	4.8	4.5	4.2	4.0
	F	0.18	23	11.9	10.2	8.9	7.9	7.1	6.5	5.9	5.5	5.1	4.8	4.5	4.2
40	M	0.17	22	11.2	9.6	8.4	7.5	6.7	6.1	5.6	5.2	4.8	4.5	4.2	4.0
	M	0.20	26	13.2	11.3	9.9	8.8	7.9	7.2	6.6	6.1	5.7	5.3	5.0	4.7
	M	0.22	28	14.5	12.4	10.9	9.7	8.7	7.9	7.3	6.7	6.2	5.8	5.4	5.1
50	M	0.24	31	15.8	13.6	11.9	10.6	9.5	8.6	7.9	7.3	6.8	6.3	5.9	5.6
	C	0.26	33	17.2	14.7	12.9	11.4	10.3	9.4	8.6	7.9	7.4	6.9	6.4	6.1
	M	0.30	38	19.8	17.0	14.9	13.2	11.9	10.8	9.9	9.1	8.5	7.9	7.4	7.0
60	M	0.34	44	22	19.2	16.8	15.0	13.5	12.2	11.2	10.4	9.6	9.0	8.4	7.9
	M	0.37	47	24	21	18.3	16.3	14.7	13.3	12.2	11.3	10.5	9.8	9.2	8.6
	C	0.35	45	23	19.8	17.3	15.4	13.9	12.6	11.6	10.7	9.9	9.2	8.7	8.2
80	C	0.40	51	26	23	19.8	17.6	15.8	14.4	13.2	12.2	11.3	10.6	9.9	9.3
	M	0.45	58	30	25	22	19.8	17.8	16.2	14.9	13.7	12.7	11.9	11.1	10.5
	M	0.49	63	32	28	24	22	19.4	17.6	16.2	14.9	13.9	12.9	12.1	11.4
100	C	0.43	55	28	24	21	18.9	17.0	15.5	14.2	13.1	12.2	11.4	10.6	10.0
	C	0.50	64	33	28	25	22	19.8	18.0	16.5	15.2	14.1	13.2	12.4	11.6
	M	0.56	72	37	32	28	25	22	20	18.5	17.1	15.8	14.8	13.9	13.0
120	M	0.61	78	40	35	30	27	24	22	20	18.6	17.3	16.1	15.1	14.2

Note: Always double check your application rates. Tabulations are based on spraying water at 70°F (21°C). See pages 136–157 for drop size classification, useful formulas and other information.

95°	GPA CONVERSION FACTORS*		
	20"	30"	
8"	4"	2.50	3.75
10"	5"	2.00	3.00
12"	5"	1.67	2.50
15"	7"	1.33	2.00

*To find GPA rate on band widths, multiply the tabulated GPA for ROW SPACING by conversion factors.

How to order:

Specify tip number.

Example:

DG95015EVS – Stainless Steel with VisiFlo color-coding



Typical Applications:

See selection guide on page 3 for recommended typical applications for TeeJet tips.

Features:

- Ideal for banding over the row or in row middles.
- Provides uniform distribution throughout the flat spray pattern.
- Easily mounted on spray boom or planter.
- Available with VisiFlo® color-coding in stainless steel or all stainless steel, hardened stainless steel and brass.



Tip	PSI	CAPACITY ONE NOZZLE IN GPM	GPA \triangle 30" \triangle Field Acres												
			3 MPH	3.5 MPH	4 MPH	4.5 MPH	5 MPH	5.5 MPH	6 MPH	6.5 MPH	7 MPH	7.5 MPH	8 MPH	8.5 MPH	
TP4001E†	20	0.071	4.7	4.0	3.5	3.1	2.8	2.6	2.3	2.2	2.0	1.9	1.8	1.7	
TP6501E†	30	0.087	5.7	4.9	4.3	3.8	3.4	3.1	2.9	2.7	2.5	2.3	2.2	2.0	
TP8001E	40	0.10	6.6	5.7	5.0	4.4	4.0	3.6	3.3	3.0	2.8	2.6	2.5	2.3	
TP9501E (100)	50	0.11	7.3	6.2	5.4	4.8	4.4	4.0	3.6	3.4	3.1	2.9	2.7	2.6	
	60	0.12	7.9	6.8	5.9	5.3	4.8	4.3	4.0	3.7	3.4	3.2	3.0	2.8	
TP40015E†	20	0.11	7.3	6.2	5.4	4.8	4.4	4.0	3.6	3.4	3.1	2.9	2.7	2.6	
TP65015E†	30	0.13	8.6	7.4	6.4	5.7	5.1	4.7	4.3	4.0	3.7	3.4	3.2	3.0	
TP80015E	40	0.15	9.9	8.5	7.4	6.6	5.9	5.4	5.0	4.6	4.2	4.0	3.7	3.5	
TP95015E (100)	50	0.17	11.2	9.6	8.4	7.5	6.7	6.1	5.6	5.2	4.8	4.5	4.2	4.0	
	60	0.18	11.9	10.2	8.9	7.9	7.1	6.5	5.9	5.5	5.1	4.8	4.5	4.2	
TP4002E†	20	0.14	9.2	7.9	6.9	6.2	5.5	5.0	4.6	4.3	4.0	3.7	3.5	3.3	
TP6502E†	30	0.17	11.2	9.6	8.4	7.5	6.7	6.1	5.6	5.2	4.8	4.5	4.2	4.0	
TP8002E	40	0.20	13.2	11.3	9.9	8.8	7.9	7.2	6.6	6.1	5.7	5.3	5.0	4.7	
TP9502E (50)	50	0.22	14.5	12.4	10.9	9.7	8.7	7.9	7.3	6.7	6.2	5.8	5.4	5.1	
	60	0.24	15.8	13.6	11.9	10.6	9.5	8.6	7.9	7.3	6.8	6.3	5.9	5.6	
TP4003E†	20	0.21	13.9	11.9	10.4	9.2	8.3	7.6	6.9	6.4	5.9	5.5	5.2	4.9	
TP6503E†	30	0.26	17.2	14.7	12.9	11.4	10.3	9.4	8.6	7.9	7.4	6.9	6.4	6.1	
TP8003E	40	0.30	19.8	17.0	14.9	13.2	11.9	10.8	9.9	9.1	8.5	7.9	7.4	7.0	
TP9503E (50)	50	0.34	22	19.2	16.8	15.0	13.5	12.2	11.2	10.4	9.6	9.0	8.4	7.9	
	60	0.37	24	21	18.3	16.3	14.7	13.3	12.2	11.3	10.5	9.8	9.2	8.6	
TP4004E†	20	0.28	18.5	15.8	13.9	12.3	11.1	10.1	9.2	8.5	7.9	7.4	6.9	6.5	
TP6504E†	30	0.35	23	19.8	17.3	15.4	13.9	12.6	11.6	10.7	9.9	9.2	8.7	8.2	
TP8004E	40	0.40	26	23	19.8	17.6	15.8	14.4	13.2	12.2	11.3	10.6	9.9	9.3	
TP9504E (50)	50	0.45	30	25	22	19.8	17.8	16.2	14.9	13.7	12.7	11.9	11.1	10.5	
	60	0.49	32	28	24	22	19.4	17.6	16.2	14.9	13.9	12.9	12.1	11.4	
TP4005E†	20	0.35	23	19.8	17.3	15.4	13.9	12.6	11.6	10.7	9.9	9.2	8.7	8.2	
TP6505E†	30	0.43	28	24	21	18.9	17.0	15.5	14.2	13.1	12.2	11.4	10.6	10.0	
TP8005E	40	0.50	33	28	25	22	19.8	18.0	16.5	15.2	14.1	13.2	12.4	11.6	
TP9505E (50)	50	0.56	37	32	28	25	22	20	18.5	17.1	15.8	14.8	13.9	13.0	
	60	0.61	40	35	30	27	24	22	20	18.6	17.3	16.1	15.1	14.2	
TP4006E†	20	0.42	28	24	21	18.5	16.6	15.1	13.9	12.8	11.9	11.1	10.4	9.8	
TP6506E†	30	0.52	34	29	26	23	21	18.7	17.2	15.8	14.7	13.7	12.9	12.1	
TP8006E	40	0.60	40	34	30	26	24	22	19.8	18.3	17.0	15.8	14.9	14.0	
TP9506E (50)	50	0.67	44	38	33	29	27	24	22	20	19.0	17.7	16.6	15.6	
	60	0.73	48	41	36	32	29	26	24	22	21	19.3	18.1	17.0	
TP6508E†	20	0.57	38	32	28	25	23	21	18.8	17.4	16.1	15.0	14.1	13.3	
TP11008E†	30	0.69	46	39	34	30	27	25	23	21	19.5	18.2	17.1	16.1	
TP8008E	40	0.80	53	45	40	35	32	29	26	24	23	21	19.8	18.6	
TP9508E (50)	50	0.89	59	50	44	39	35	32	29	27	25	23	22	21	
	60	0.98	65	55	49	43	39	35	32	30	28	26	24	23	
TP4010E†	20	0.71	47	40	35	31	28	26	23	22	20	18.7	17.6	16.5	
TP6510E†	30	0.87	57	49	43	38	34	31	29	27	25	23	22	20	
TP8010E†	40	1.00	66	57	50	44	40	36	33	30	28	26	25	23	
TP11010E†	50	1.12	74	63	55	49	44	40	37	34	32	30	28	26	
	60	1.22	81	69	60	54	48	44	40	37	35	32	30	28	
TP6515E†	20	1.06	70	60	52	47	42	38	35	32	30	28	26	25	
TP8015E†	30	1.30	86	74	64	57	51	47	43	40	37	34	32	30	
TP11015E†	40	1.50	99	85	74	66	59	54	50	46	42	40	37	35	
	50	1.68	111	95	83	74	67	60	55	51	48	44	42	39	
	60	1.84	121	104	91	81	73	66	61	56	52	49	46	43	

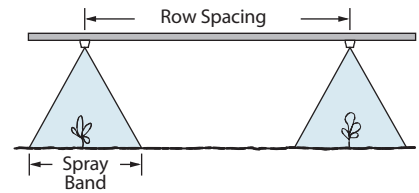

Tip	GPA Conversion Factors*					GPA Conversion Factors*	
	40°	65°	80°	95°	110°	20"	30"
8"	11"	6"	5"	4"	3"	2.50	3.75
10"	14"	8"	6"	5"	4"	2.00	3.00
12"	16"	9"	7"	5"	4"	1.67	2.50
15"	21"	12"	9"	7"	5"	1.33	2.00

*To find GPA rate on band widths, multiply the tabulated GPA for ROW SPACING by conversion factors.

How to order:

Specify tip number.

Examples:

- TP8002EVS – Stainless Steel with VisiFlo color-coding
- TP8002E-HSS – Hardened Stainless Steel
- TP8002E-SS – Stainless Steel
- TP8002E – Brass

Note: Always double check your application rates. Tabulations are based on spraying water at 70°F (21°C). See pages 136–157 for useful formulas and other information. †Available in brass and/or stainless steel and/or hardened stainless steel.



TwinJet® Even Flat Spray Tips



40° and 80° E Series

TwinJet even tips combine the advantages of twin flat spray patterns with even distribution across the pattern. The twin flat sprays provide improved coverage of crop or weed without sacrificing uniformity. The smaller droplet size makes this tip ideal for providing a thorough, penetrating coverage with post-emergence contact herbicides.

These tips also provide good pre-emergence coverage on cloddy fields and fields covered with crop residue.

See selection guide on page 3 for recommended typical applications for TwinJet tips.



Features:

- Ideal for banding over or between crop rows.
- Provides uniform distribution throughout the spray pattern.
- Available in 80° and 40° twin flat spray patterns.
- Made of stainless steel with VisiFlo® coding.
- Can be used with 25598 Quick TeeJet® cap. See page 64 for more information.

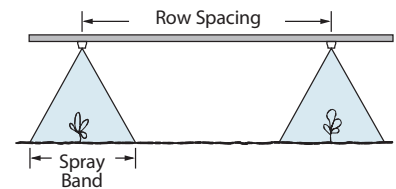
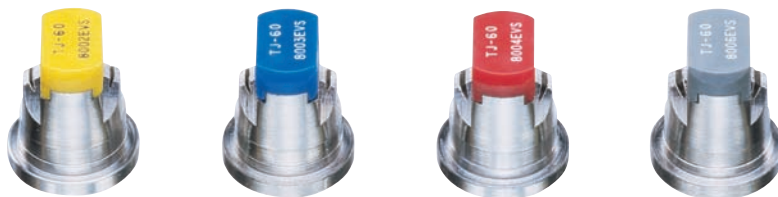

Tip Model	PSI	DROP SIZE	CAPACITY ONE NOZZLE IN GPM	CAPACITY ONE NOZZLE IN OZ./MIN.	GPA 30' Field Acres													
					3 MPH	3.5 MPH	4 MPH	4.5 MPH	5 MPH	5.5 MPH	6 MPH	6.5 MPH	7 MPH	7.5 MPH	8 MPH	8.5 MPH		
TJ60-4002EVS TJ60-8002EVS (100)	30	F	0.17	22	11.2	9.6	8.4	7.5	6.7	6.1	5.6	5.2	4.8	4.5	4.2	4.0		
	40	F	0.20	26	13.2	11.3	9.9	8.8	7.9	7.2	6.6	6.1	5.7	5.3	5.0	4.7		
	50	F	0.22	28	14.5	12.4	10.9	9.7	8.7	7.9	7.3	6.7	6.2	5.8	5.4	5.1		
	60	F	0.24	31	15.8	13.6	11.9	10.6	9.5	8.6	7.9	7.3	6.8	6.3	5.9	5.6		
TJ60-4003EVS TJ60-8003EVS (100)	30	F	0.26	33	17.2	14.7	12.9	11.4	10.3	9.4	8.6	7.9	7.4	6.9	6.4	6.1		
	40	F	0.30	38	19.8	17.0	14.9	13.2	11.9	10.8	9.9	9.1	8.5	7.9	7.4	7.0		
	50	F	0.34	44	22	19.2	16.8	15.0	13.5	12.2	11.2	10.4	9.6	9.0	8.4	7.9		
	60	F	0.37	47	24	21	18.3	16.3	14.7	13.3	12.2	11.3	10.5	9.8	9.2	8.6		
TJ60-4004EVS TJ60-8004EVS (50)	30	M	0.35	45	23	19.8	17.3	15.4	13.9	12.6	11.6	10.7	9.9	9.2	8.7	8.2		
	40	F	0.40	51	26	23	19.8	17.6	15.8	14.4	13.2	12.2	11.3	10.6	9.9	9.3		
	50	F	0.45	58	30	25	22	19.8	17.8	16.2	14.9	13.7	12.7	11.9	11.1	10.5		
	60	F	0.49	63	32	28	24	22	19.4	17.6	16.2	14.9	13.9	12.9	12.1	11.4		
TJ60-8006EVS (50)	30	M	0.52	67	34	29	26	23	21	18.7	17.2	15.8	14.7	13.7	12.9	12.1		
	40	M	0.60	77	40	34	30	26	24	22	19.8	18.3	17.0	15.8	14.9	14.0		
	50	M	0.67	86	44	38	33	29	27	24	22	20	19.0	17.7	16.6	15.6		
	60	M	0.73	93	48	41	36	32	29	26	24	22	21	19.3	18.1	17.0		

Band Width	GPA Conversion Factors*		GPA Conversion Factors*	
	40°	80°	20'	30'
8"	11"	5"	2.50	3.75
10"	14"	6"	2.00	3.00
12"	16"	7"	1.67	2.50
15"	21"	9"	1.33	2.00

*To find GPA rate on band widths, multiply the tabulated GPA for ROW SPACING by conversion factors.

How to order:

Specify tip number.

Example:

TJ60-4002EVS – Stainless Steel with VisiFlo color-coding

Note: Always double check your application rates. Tabulations are based on spraying water at 70°F (21°C). See pages 136–157 for drop size classification, useful formulas and other information.



Air Induction Underleaf Banding Spray Tip

- Larger droplets for less drift.
- Off-center spray pattern with flat spray characteristics.
- Underleaf banding of pesticides or liquid fertilizers.
- Used at the end of the spray boom around the perimeter of the field to protect sensitive areas.
- Spraying pressure of 30–115 PSI (2–8 bar).
- Can be used with 25598*-NYR Quick TeeJet® cap. See page 64 for more information.

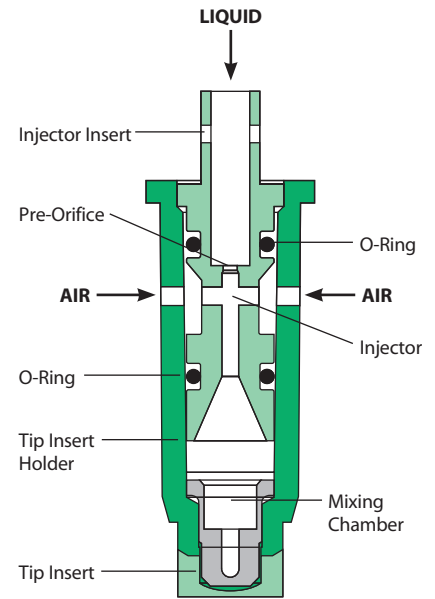

Note: Due to the pre-orifice design, this tip is not compatible with the 4193A check valve.

Nozzle Icon	PSI	DROP SIZE	CAPACITY ONE NOZZLE IN GPM	CAPACITY ONE NOZZLE IN OZ./MIN.	GPA 20"								GPA 30"							
					3 MPH	4 MPH	5 MPH	6 MPH	7 MPH	8 MPH	3 MPH	4 MPH	5 MPH	6 MPH	7 MPH	8 MPH				
					3 MPH	4 MPH	5 MPH	6 MPH	7 MPH	8 MPH	3 MPH	4 MPH	5 MPH	6 MPH	7 MPH	8 MPH				
AIUB8502 (50)	30	UC	0.17	22	16.8	12.6	10.1	8.4	7.2	6.3	11.2	8.4	6.7	5.6	4.8	4.2				
	40	XC	0.20	26	19.8	14.9	11.9	9.9	8.5	7.4	13.2	9.9	7.9	6.6	5.7	5.0				
	50	XC	0.22	28	22	16.3	13.1	10.9	9.3	8.2	14.5	10.9	8.7	7.3	6.2	5.4				
	60	VC	0.24	31	24	17.8	14.3	11.9	10.2	8.9	15.8	11.9	9.5	7.9	6.8	5.9				
	70	VC	0.26	33	26	19.3	15.4	12.9	11.0	9.7	17.2	12.9	10.3	8.6	7.4	6.4				
	80	VC	0.28	36	28	21	16.6	13.9	11.9	10.4	18.5	13.9	11.1	9.2	7.9	6.9				
	90	VC	0.30	38	30	22	17.8	14.9	12.7	11.1	19.8	14.9	11.9	9.9	8.5	7.4				
100	C	0.32	41	32	24	19.0	15.8	13.6	11.9	21	15.8	12.7	10.6	9.1	7.9					
AIUB85025 (50)	30	UC	0.22	28	22	16.3	13.1	10.9	9.3	8.2	14.5	10.9	8.7	7.3	6.2	5.4				
	40	XC	0.25	32	25	18.6	14.9	12.4	10.6	9.3	16.5	12.4	9.9	8.3	7.1	6.2				
	50	XC	0.28	36	28	21	16.6	13.9	11.9	10.4	18.5	13.9	11.1	9.2	7.9	6.9				
	60	XC	0.31	40	31	23	18.4	15.3	13.2	11.5	20	15.3	12.3	10.2	8.8	7.7				
	70	VC	0.33	42	33	25	19.6	16.3	14.0	12.3	22	16.3	13.1	10.9	9.3	8.2				
	80	VC	0.35	45	35	26	21	17.3	14.9	13.0	23	17.3	13.9	11.6	9.9	8.7				
	90	VC	0.38	49	38	28	23	18.8	16.1	14.1	25	18.8	15.0	12.5	10.7	9.4				
100	C	0.40	51	40	30	24	19.8	17.0	14.9	26	19.8	15.8	13.2	11.3	9.9					
AIUB8503 (50)	30	UC	0.26	33	26	19.3	15.4	12.9	11.0	9.7	17.2	12.9	10.3	8.6	7.4	6.4				
	40	XC	0.30	38	30	22	17.8	14.9	12.7	11.1	19.8	14.9	11.9	9.9	8.5	7.4				
	50	XC	0.34	44	34	25	20	16.8	14.4	12.6	22	16.8	13.5	11.2	9.6	8.4				
	60	XC	0.37	47	37	27	22	18.3	15.7	13.7	24	18.3	14.7	12.2	10.5	9.2				
	70	VC	0.40	51	40	30	24	19.8	17.0	14.9	26	19.8	15.8	13.2	11.3	9.9				
	80	VC	0.42	54	42	31	25	21	17.8	15.6	28	21	16.6	13.9	11.9	10.4				
	90	VC	0.45	58	45	33	27	22	19.1	16.7	30	22	17.8	14.9	12.7	11.1				
100	C	0.47	60	47	35	28	23	19.9	17.4	31	23	18.6	15.5	13.3	11.6					
AIUB8504 (50)	30	UC	0.35	45	35	26	21	17.3	14.9	13.0	23	17.3	13.9	11.6	9.9	8.7				
	40	XC	0.40	51	40	30	24	19.8	17.0	14.9	26	19.8	15.8	13.2	11.3	9.9				
	50	XC	0.45	58	45	33	27	22	19.1	16.7	30	22	17.8	14.9	12.7	11.1				
	60	XC	0.49	63	49	36	29	24	21	18.2	32	24	19.4	16.2	13.9	12.1				
	70	VC	0.53	68	52	39	31	26	22	19.7	35	26	21	17.5	15.0	13.1				
	80	VC	0.57	73	56	42	34	28	24	21	38	28	23	18.8	16.1	14.1				
	90	VC	0.60	77	59	45	36	30	25	22	40	30	24	19.8	17.0	14.9				
100	C	0.63	81	62	47	37	31	27	23	42	31	25	21	17.8	15.6					

Note: Always double check your application rates. Tabulations are based on spraying water at 70°F (21°C). See pages 136–157 for drop size classification, useful formulas and other information.

Typical Applications:

- Used at the end of the spray boom around the perimeter of the field to protect sensitive areas.

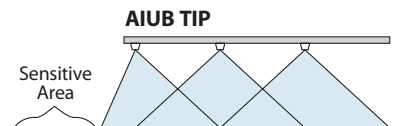

- Underleaf banding of pesticides or liquid fertilizers.

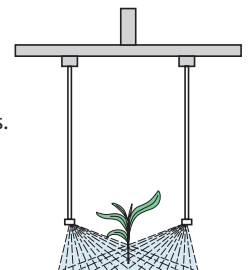

How to order:

Specify tip number.

Example:

AIUB85025-VS – Stainless Steel with VisiFlo® color-coding

Provides coarse spray with full cone pattern. Used frequently for tobacco plant sucker control.

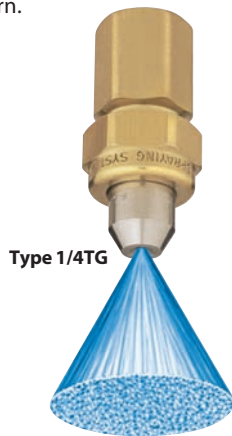

Type 1/4TG



Three Nozzles Per Row Spacing

See pages 136–157 for useful formulas and other information.

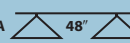
Tip	PSI	CAPACITY ONE NOZZLE IN GPM	CAPACITY ONE NOZZLE IN OZ./MIN.	GPA  48" (THREE NOZZLES PER ROW)							
				2 MPH	2.5 MPH	3 MPH	3.5 MPH	4 MPH	4.5 MPH	5 MPH	5.5 MPH
TG-1	20	0.14	18	26	21	17.3	14.9	13.0	11.6	10.4	9.5
	30	0.16	20	30	24	19.8	17.0	14.9	13.2	11.9	10.8
	40	0.19	24	35	28	24	20	17.6	15.7	14.1	12.8
	60	0.23	29	43	34	28	24	21	19.0	17.1	15.5
TG-2	20	0.28	36	52	42	35	30	26	23	21	18.9
	30	0.33	42	61	49	41	35	31	27	25	22
	40	0.38	49	71	56	47	40	35	31	28	26
	60	0.46	59	85	68	57	49	43	38	34	31
TG-3	20	0.41	52	76	61	51	43	38	34	30	28
	30	0.50	64	93	74	62	53	46	41	37	34
	40	0.57	73	106	85	71	60	53	47	42	38
	60	0.68	87	126	101	84	72	63	56	50	46
TG-4	20	0.55	70	102	82	68	58	51	45	41	37
	30	0.66	84	123	98	82	70	61	54	49	45
	40	0.76	97	141	113	94	81	71	63	56	51
	60	0.91	116	169	135	113	97	84	75	68	61
TG-5	20	0.69	88	128	102	85	73	64	57	51	47
	30	0.84	108	156	125	104	89	78	69	62	57
	40	1.00	128	186	149	124	106	93	83	74	68
	60	1.16	148	215	172	144	123	108	96	86	78
TG-6	20	0.82	105	152	122	101	87	76	68	61	55
	30	0.99	127	184	147	123	105	92	82	74	67
	40	1.14	146	212	169	141	121	106	94	85	77
	60	1.37	175	254	203	170	145	127	113	102	92
TG-8	20	1.10	141	204	163	136	117	102	91	82	74
	30	1.33	170	247	198	165	141	123	110	99	90
	40	1.51	193	280	224	187	160	140	125	112	102
	60	1.82	233	338	270	225	193	169	150	135	123

Note: Always double check your application rates. Tabulations are based on spraying water at 70°F (21°C).

Features:

- Off-center tip with tapered flat spray characteristics.
- 85° spray angle.
- Available in brass or stainless steel.
- Operating pressure 20–60 PSI (1.5–4 bar).
- Uniform distribution.
- Capacities of 0075 to 04.



Typical Applications:

- Underleaf band application of contact herbicides in combination with mechanical cultivation.
- Band application of contact herbicides or liquid fertilizer.

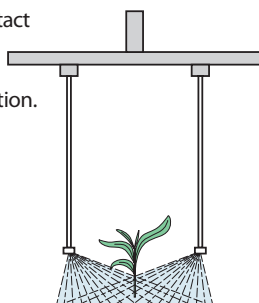

UB

Sensitive Area

See pages 136–157 for useful formulas and other information.

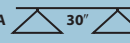
Tip	PSI	CAPACITY TWO NOZZLES IN GPM	CAPACITY TWO NOZZLES IN OZ./MIN.	GPA  30" (TWO NOZZLES PER ROW)										
				2 MPH	2.5 MPH	3 MPH	3.5 MPH	4 MPH	4.5 MPH	5 MPH	5.5 MPH	6 MPH	6.5 MPH	7 MPH
D25143-UB-850075 (100)	20	0.11	14	10.9	8.7	7.3	6.2	5.4	4.8	4.4	4.0	3.6	3.4	3.1
	30	0.13	17	12.9	10.3	8.6	7.4	6.4	5.7	5.1	4.7	4.3	4.0	3.7
	40	0.15	19	14.9	11.9	9.9	8.5	7.4	6.6	5.9	5.4	5.0	4.6	4.2
	50	0.17	22	16.8	13.5	11.2	9.6	8.4	7.5	6.7	6.1	5.6	5.2	4.8
	60	0.18	23	17.8	14.3	11.9	10.2	8.9	7.9	7.1	6.5	5.9	5.5	5.1
D25143-UB-8501 (100)	20	0.14	18	13.9	11.1	9.2	7.9	6.9	6.2	5.5	5.0	4.6	4.3	4.0
	30	0.17	22	16.8	13.5	11.2	9.6	8.4	7.5	6.7	6.1	5.6	5.2	4.8
	40	0.20	26	19.8	15.8	13.2	11.3	9.9	8.8	7.9	7.2	6.6	6.1	5.7
	50	0.22	28	22	17.4	14.5	12.4	10.9	9.7	8.7	7.9	7.3	6.7	6.2
	60	0.24	31	24	19.0	15.8	13.6	11.9	10.6	9.5	8.6	7.9	7.3	6.8
D25143-UB-85015 (80)	20	0.21	27	21	16.6	13.9	11.9	10.4	9.2	8.3	7.6	6.9	6.4	5.9
	30	0.26	33	26	21	17.2	14.7	12.9	11.4	10.3	9.4	8.6	7.9	7.4
	40	0.30	38	30	24	19.8	17.0	14.9	13.2	11.9	10.8	9.9	9.1	8.5
	50	0.34	44	34	27	22	19.2	16.8	15.0	13.5	12.2	11.2	10.4	9.6
	60	0.37	47	37	29	24	21	18.3	16.3	14.7	13.3	12.2	11.3	10.5
D25143-UB-8502 (50)	20	0.28	36	28	22	18.5	15.8	13.9	12.3	11.1	10.1	9.2	8.5	7.9
	30	0.35	45	35	28	23	19.8	17.3	15.4	13.9	12.6	11.6	10.7	9.9
	40	0.40	51	40	32	26	23	19.8	17.6	15.8	14.4	13.2	12.2	11.3
	50	0.45	58	45	36	30	25	22	19.8	17.8	16.2	14.9	13.7	12.7
	60	0.49	63	49	39	32	28	24	22	19.4	17.6	16.2	14.9	13.9
D25143-UB-8503 (50)	20	0.42	54	42	33	28	24	21	18.5	16.6	15.1	13.9	12.8	11.9
	30	0.52	67	51	41	34	29	26	23	21	18.7	17.2	15.8	14.7
	40	0.60	77	59	48	40	34	30	26	24	22	19.8	18.3	17.0
	50	0.67	86	66	53	44	38	33	29	27	24	22	20	19.0
	60	0.73	93	72	58	48	41	36	32	29	26	24	22	21
D25143-UB-8504 (50)	20	0.57	73	56	45	38	32	28	25	23	21	18.8	17.4	16.1
	30	0.69	88	68	55	46	39	34	30	27	25	23	21	19.5
	40	0.80	102	79	63	53	45	40	35	32	29	26	24	23
	50	0.89	114	88	70	59	50	44	39	35	32	29	27	25
	60	0.98	125	97	78	65	55	49	43	39	35	32	30	28

Note: Always double check your application rates. Tabulations are based on spraying water at 70°F (21°C).

Underleaf Band Application

- Directed application under crop canopy.
- Nozzle spacing 10" (0.25 m)—two tips per row.
- Adjust tip height and nozzle orientation to achieve desired band width.

How to order:

Specify tip number and material.

Examples:

D25143-UB-8501 – Brass

D25143-UB-8501-SS – Stainless Steel



Typical Applications:

See selection guide on page 5 for recommended typical applications for ConeJet tips.

Features:

- Polypropylene body and ceramic orifice insert for long wear life.
- Resists corrosion.

- Accepts more abrasive materials.
- Popular nozzle sizes fit most sprayers.
- Operating pressures to 300 PSI (20 bar).
- Incorporates ISO color-coding scheme.
- Ideal for banding with two or three nozzles over the row.
- Finely atomized spray pattern provides thorough coverage.

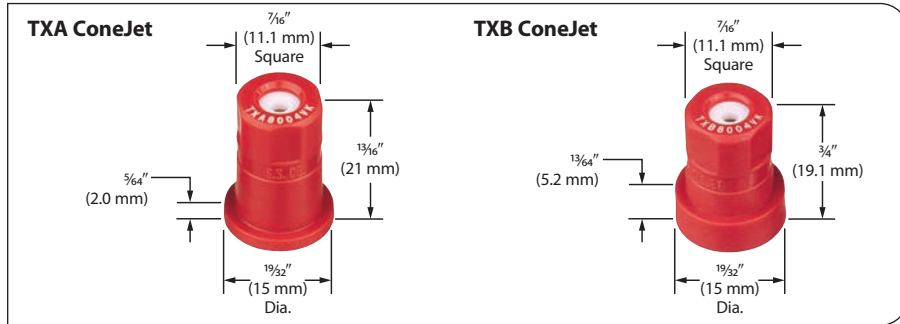
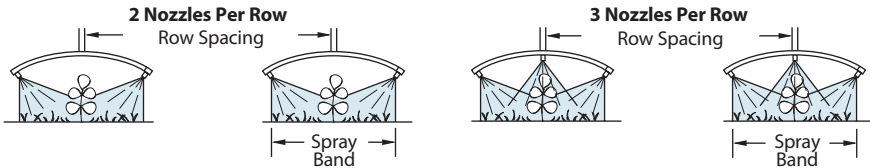

	GPA CONVERSION FACTORS*	
	8"	10"
	3.75	3.00
	2.50	2.00

*To find GPA rate on band widths, multiply the tabulated GPA for ROW SPACING by the conversion factors.

How to order:

Specify tip number.

Example:

TXA8004VK – Ceramic with VisiFlo color-coding



		PSI	DROP SIZE	CAPACITY TWO NOZZLES IN GPM	CAPACITY TWO NOZZLES IN OZ./MIN.	GPA					PSI	CAPACITY THREE NOZZLES IN GPM	CAPACITY THREE NOZZLES IN OZ./MIN.	GPA				
						3 MPH	4 MPH	5 MPH	6 MPH	7 MPH				3 MPH	4 MPH	5 MPH	6 MPH	7 MPH
TXA800050VK	40	VF	0.10	13	6.6	5.0	4.0	3.3	2.8	40	0.15	19	9.9	7.4	5.9	5.0	4.2	
TXB800050VK	60	VF	0.12	15	7.9	5.9	4.8	4.0	3.4	60	0.18	23	11.9	8.9	7.1	5.9	5.1	
(100)	80	VF	0.14	18	9.2	6.9	5.5	4.6	4.0	80	0.20	26	13.2	9.9	7.9	6.6	5.7	
	100	VF	0.15	19	9.9	7.4	5.9	5.0	4.2	100	0.22	28	14.5	10.9	8.7	7.3	6.2	
	125	VF	0.16	20	10.6	7.9	6.3	5.3	4.5	125	0.25	32	16.5	12.4	9.9	8.3	7.1	
TXA800067VK	40	VF	0.13	17	8.6	6.4	5.1	4.3	3.7	40	0.20	26	13.2	9.9	7.9	6.6	5.7	
TXB800067VK	60	VF	0.16	20	10.6	7.9	6.3	5.3	4.5	60	0.24	31	15.8	11.9	9.5	7.9	6.8	
(50)	80	VF	0.18	23	11.9	8.9	7.1	5.9	5.1	80	0.27	35	17.8	13.4	10.7	8.9	7.6	
	100	VF	0.20	26	13.4	10.0	8.0	6.7	5.7	100	0.30	39	20	15.0	12.0	10.0	8.6	
	125	VF	0.22	29	14.8	11.1	8.9	7.4	6.3	125	0.34	43	22	16.6	13.3	11.1	9.5	
TXA8001VK	40	F	0.20	26	13.2	9.9	7.9	6.6	5.7	40	0.30	38	19.8	14.9	11.9	9.9	8.5	
TXB8001VK	60	VF	0.24	31	15.9	11.9	9.5	7.9	6.8	60	0.36	46	24	17.9	14.3	11.9	10.2	
(50)	80	VF	0.27	35	18.1	13.6	10.9	9.1	7.8	80	0.41	53	27	20	16.3	13.6	11.6	
	100	VF	0.30	39	20	15.0	12.0	10.0	8.6	100	0.46	58	30	23	18.0	15.0	12.9	
	125	VF	0.34	43	22	16.6	13.3	11.1	9.5	125	0.50	65	33	25	20	16.6	14.3	
TXA80015VK	40	F	0.30	38	19.8	14.9	11.9	9.9	8.5	40	0.45	58	30	22	17.8	14.9	12.7	
TXB80015VK	60	F	0.36	47	24	18.0	14.4	12.0	10.3	60	0.55	70	36	27	22	18.0	15.5	
(50)	80	VF	0.42	53	28	21	16.5	13.8	11.8	80	0.63	80	41	31	25	21	17.7	
	100	VF	0.46	60	31	23	18.4	15.3	13.1	100	0.70	89	46	35	28	23	19.7	
	125	VF	0.52	66	34	26	20	17.1	14.6	125	0.78	99	51	38	31	26	22	
TXA8002VK	40	F	0.40	51	26	19.8	15.8	13.2	11.3	40	0.60	77	40	30	24	19.8	17.0	
TXB8002VK	60	F	0.49	62	32	24	19.2	16.0	13.7	60	0.73	93	48	36	29	24	21	
(50)	80	VF	0.56	71	37	28	22	18.4	15.8	80	0.84	107	55	41	33	28	24	
	100	VF	0.62	79	41	31	25	20	17.5	100	0.93	119	61	46	37	31	26	
	125	VF	0.69	88	46	34	27	23	19.5	125	1.03	132	68	51	41	34	29	
TXA8003VK	40	F	0.60	77	40	30	24	19.8	17.0	40	0.90	115	59	45	36	30	25	
TXB8003VK	60	F	0.73	94	48	36	29	24	21	60	1.10	141	73	54	44	36	31	
(50)	80	F	0.85	108	56	42	34	28	24	80	1.27	162	84	63	50	42	36	
	100	VF	0.94	121	62	47	37	31	27	100	1.42	181	94	70	56	47	40	
	125	VF	1.06	135	70	52	42	35	30	125	1.58	203	105	78	63	52	45	
TXA8004VK	40	F	0.80	102	53	40	32	26	23	40	1.20	154	79	59	48	40	34	
TXB8004VK	60	F	0.98	125	65	48	39	32	28	60	1.47	188	97	73	58	48	42	
(50)	80	F	1.13	144	74	56	45	37	32	80	1.69	217	112	84	67	56	48	
	100	VF	1.26	161	83	62	50	42	36	100	1.89	242	125	94	75	62	53	
	125	VF	1.41	180	93	70	56	46	40	125	2.11	270	139	105	84	70	60	

Note: Always double check your application rates. Tabulations are based on spraying water at 70°F (21°C). See pages 136–157 for useful formulas and other information.



ConeJet® VisiFlo® Hollow Cone Spray Tips

Typical Applications:

Use for directed applications in air blast spraying for orchards and vineyards and other specialty crops. Also well-suited for applications of insecticides, fungicides, defoliants and foliar fertilizers at pressures of 40 PSI (3 bar) and above.

Features:

- VisiFlo color-coded version consists of stainless steel or ceramic orifice in polypropylene body. Maximum operating pressure 300 PSI (20 bar). Spray angle is 80° at 100 PSI (7 bar).
- Finely atomized spray pattern provides thorough coverage.
- TX-VS1 and TX-VS2 available in VisiFlo color-coded stainless steel only.



How to order:

Specify tip number.

Examples:

- TX-VS4 – Stainless Steel with VisiFlo color-coding
- TX-4 – Brass
- TX-SS4 – Stainless Steel
- TX-VK4 – Ceramic with VisiFlo color-coding



Tip	Orifice	GPM																	
		30 PSI	40 PSI	50 PSI	60 PSI	70 PSI	80 PSI	90 PSI	100 PSI	120 PSI	140 PSI	160 PSI	180 PSI	200 PSI	220 PSI	240 PSI	260 PSI	280 PSI	300 PSI
TX-VS1	100	0.015	0.017	0.018	0.020	0.021	0.022	0.023	0.024	0.026	0.028	0.030	0.031	0.032	0.034	0.035	0.036	0.037	0.038
		VF	VF	VF	VF	VF	VF	VF	VF	VF	VF	VF	VF	VF	VF	VF	VF	VF	VF
TX-VS2	100	0.029	0.033	0.037	0.040	0.043	0.045	0.047	0.050	0.054	0.058	0.061	0.064	0.067	0.070	0.073	0.075	0.078	0.080
		VF	VF	VF	VF	VF	VF	VF	VF	VF	VF	VF	VF	VF	VF	VF	VF	VF	VF
TX-VK3	100	0.044	0.050	0.055	0.060	0.064	0.068	0.071	0.075	0.081	0.086	0.092	0.096	0.101	0.105	0.109	0.113	0.117	0.120
		F	VF	VF	VF	VF	VF	VF	VF	VF	VF	VF	VF	VF	VF	VF	VF	VF	VF
TX-VK4	50	0.058	0.067	0.074	0.080	0.086	0.091	0.096	0.101	0.110	0.118	0.125	0.132	0.139	0.145	0.151	0.157	0.162	0.167
		F	VF	VF	VF	VF	VF	VF	VF	VF	VF	VF	VF	VF	VF	VF	VF	VF	VF
TX-VK6	50	0.088	0.100	0.111	0.120	0.129	0.137	0.145	0.152	0.165	0.177	0.188	0.199	0.208	0.218	0.226	0.235	0.243	0.251
		F	F	VF	VF	VF	VF	VF	VF	VF	VF	VF	VF	VF	VF	VF	VF	VF	VF
TX-VK8	50	0.116	0.133	0.148	0.162	0.174	0.186	0.196	0.207	0.225	0.243	0.259	0.274	0.288	0.301	0.314	0.326	0.338	0.349
		F	F	VF	VF	VF	VF	VF	VF	VF	VF	VF	VF	VF	VF	VF	VF	VF	VF
TX-VK10	50	0.145	0.167	0.185	0.202	0.218	0.232	0.246	0.258	0.282	0.303	0.323	0.342	0.360	0.376	0.392	0.408	0.422	0.437
		F	F	F	F	VF	VF	VF	VF	VF	VF	VF	VF	VF	VF	VF	VF	VF	VF
TX-VK12	50	0.174	0.200	0.223	0.243	0.261	0.279	0.295	0.310	0.338	0.364	0.388	0.410	0.432	0.452	0.471	0.489	0.507	0.524
		F	F	F	F	VF	VF	VF	VF	VF	VF	VF	VF	VF	VF	VF	VF	VF	VF
TX-VK18	50	0.260	0.300	0.335	0.367	0.396	0.423	0.449	0.473	0.517	0.558	0.597	0.633	0.667	0.699	0.730	0.759	0.788	0.815
		F	F	F	F	F	F	VF	VF	VF	VF	VF	VF	VF	VF	VF	VF	VF	VF
TX-VK26	50	0.376	0.433	0.484	0.530	0.572	0.611	0.648	0.683	0.747	0.807	0.862	0.914	0.963	1.01	1.05	1.10	1.14	1.18
		F	F	F	F	F	F	VF	VF	VF	VF	VF	VF	VF	VF	VF	VF	VF	VF

Note: Always double check your application rates. Tabulations are based on spraying water at 70°F (21°C). See pages 136–157 for useful formulas and other information.

ConeJet® VisiFlo® Hollow Cone Spray Tips



Typical Applications:

Use for directed applications in air blast spraying for orchards and vineyards and other specialty crops. Also well-suited for applications of insecticides, fungicides, defoliants and foliar fertilizers at pressures of 40 PSI (3 bar) and above.

Features:

- Maximum operating pressure 300 PSI (20 bar). Spray angle is 80° at 100 PSI (7 bar).
- Finely atomized spray pattern provides thorough coverage.
- Longer wear life.
- Resists corrosion.
- Accepts more abrasive pesticide formulation.
- Polypropylene body for use with corrosive materials and ceramic insert.
- Popular nozzle sizes fit most sprayers.
- Incorporates ISO color-coding scheme.

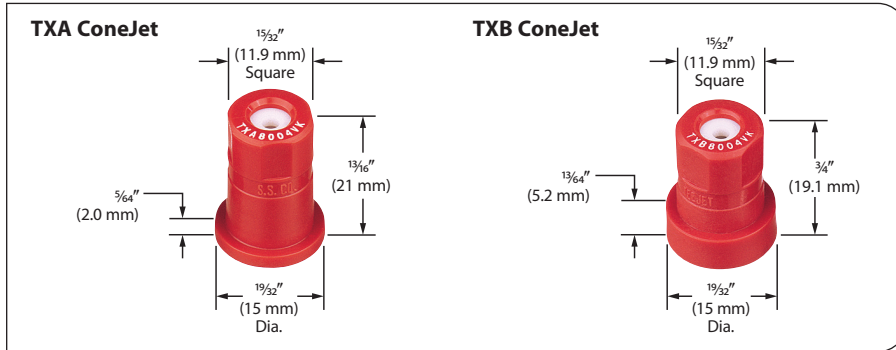

How to order:

Specify tip number.

Example:

TXA8004VK – Ceramic with VisiFlo color-coding

Tip Part Number	Tip Size	GPM																	
		30 PSI	40 PSI	50 PSI	60 PSI	70 PSI	80 PSI	90 PSI	100 PSI	120 PSI	140 PSI	160 PSI	180 PSI	200 PSI	220 PSI	240 PSI	260 PSI	280 PSI	300 PSI
TXA800050VK TXB800050VK (100)	100	0.044	0.050	0.055	0.060	0.064	0.068	0.071	0.075	0.081	0.086	0.092	0.096	0.101	0.105	0.109	0.113	0.117	0.120
TXA800067VK TXB800067VK (50)	50	0.058	0.067	0.074	0.080	0.086	0.091	0.096	0.101	0.110	0.118	0.125	0.132	0.139	0.145	0.151	0.157	0.162	0.167
TXA8001VK TXB8001VK (50)	50	0.088	0.100	0.111	0.120	0.129	0.137	0.145	0.152	0.165	0.177	0.188	0.199	0.208	0.218	0.226	0.235	0.243	0.251
TXA80015VK TXB80015VK (50)	50	0.131	0.150	0.167	0.182	0.196	0.209	0.221	0.232	0.254	0.273	0.291	0.308	0.324	0.339	0.353	0.367	0.380	0.393
TXA8002VK TXB8002VK (50)	50	0.174	0.200	0.223	0.243	0.261	0.279	0.295	0.310	0.338	0.364	0.388	0.410	0.432	0.452	0.471	0.489	0.507	0.524
TXA8003VK TXB8003VK (50)	50	0.260	0.300	0.335	0.367	0.396	0.423	0.449	0.473	0.517	0.558	0.597	0.633	0.667	0.699	0.730	0.759	0.788	0.815
TXA8004VK TXB8004VK (50)	50	0.347	0.400	0.447	0.489	0.528	0.564	0.598	0.630	0.690	0.745	0.796	0.843	0.889	0.932	0.973	1.01	1.05	1.09

Note: Always double check your application rates. Tabulations are based on spraying water at 70°F (21°C). See pages 136–157 for useful formulas and other information.



TXR ConeJet® Hollow Cone Spray Tips

Typical Applications:

Use for directed applications in air blast spraying for orchards and vineyards and other specialty crops. Also well-suited for applications of insecticides, fungicides, defoliants and foliar fertilizers at pressures of 40 PSI (3 bar) and above.

Features:

- Produces uniform, 80° hollow cone spray pattern ideal for airblast, directed and specialty applications.
- Flow rates are matched to serve as a direct replacement for commonly used non-TeeJet hollow cone spray tips.
- High-quality ceramic orifice provides superior wear life, including high-pressure operation.
- Low profile acetal tip body provides minimal impact with foliage and excellent chemical resistance.
- Color-coded holder based on tip flow rate allows for easy capacity identification.

- Snap-fit backup plate provides positive retention when handled in field, but allows for tool-free removal for easy cleaning.
- Best suited for use with TeeJet 98450 series brass rollover fittings.
- Compatible with TeeJet cap CP20230 for use on rollovers and threaded nozzle bodies, tighten to a maximum torque of: 100 in-lbs (11 N-m).
- Suggested spray pressure range of 30–360 PSI (2–25 bar).
- Uses 114396-1-NYR Quick TeeJet® cap, gasket and O-ring. Reference page 64 for more information.

How to order:

Specify tip number.

Examples:

TXR8003VK – Ceramic with color-coding

TXR8003VK-100X – Ceramic with color-coding, 100 Tip Pack

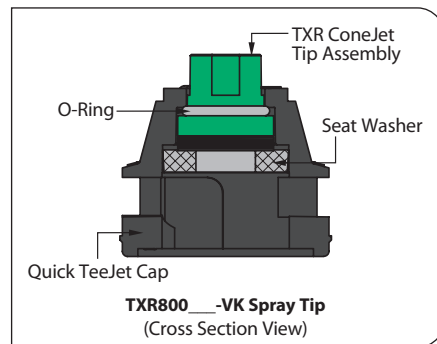

Tip Part Number	Flow Rate (GPM)	GPM																				
		30 PSI	40 PSI	50 PSI	60 PSI	70 PSI	80 PSI	90 PSI	100 PSI	120 PSI	140 PSI	160 PSI	180 PSI	200 PSI	220 PSI	240 PSI	260 PSI	280 PSI	300 PSI	320 PSI	340 PSI	360 PSI
TXR800053VK	100	0.046	0.053	0.059	0.064	0.069	0.073	0.077	0.081	0.089	0.095	0.101	0.107	0.113	0.118	0.123	0.127	0.132	0.136	0.140	0.144	0.148
TXR800071VK	50	0.062	0.071	0.079	0.086	0.093	0.099	0.105	0.110	0.120	0.129	0.138	0.146	0.153	0.160	0.167	0.174	0.180	0.186	0.192	0.197	0.203
TXR8001VK	50	0.087	0.100	0.111	0.121	0.131	0.139	0.147	0.155	0.169	0.182	0.194	0.205	0.216	0.226	0.235	0.245	0.253	0.262	0.270	0.278	0.286
TXR80013VK	50	0.116	0.133	0.148	0.162	0.174	0.186	0.196	0.207	0.225	0.243	0.259	0.274	0.288	0.301	0.314	0.326	0.338	0.349	0.360	0.371	0.381
TXR80015VK	50	0.131	0.150	0.167	0.182	0.196	0.209	0.221	0.232	0.254	0.273	0.291	0.308	0.324	0.339	0.353	0.367	0.380	0.393	0.405	0.417	0.429
TXR80017VK	50	0.145	0.167	0.185	0.202	0.218	0.232	0.246	0.258	0.282	0.303	0.323	0.342	0.360	0.376	0.392	0.408	0.422	0.437	0.450	0.464	0.476
TXR8002VK	50	0.174	0.200	0.223	0.243	0.261	0.279	0.295	0.310	0.338	0.364	0.388	0.410	0.432	0.452	0.471	0.489	0.507	0.524	0.540	0.556	0.572
TXR80028VK	50	0.240	0.275	0.306	0.334	0.359	0.383	0.405	0.426	0.465	0.500	0.533	0.564	0.594	0.621	0.648	0.673	0.697	0.720	0.743	0.765	0.786
TXR8003VK	50	0.260	0.300	0.335	0.367	0.396	0.423	0.449	0.473	0.517	0.558	0.597	0.633	0.667	0.699	0.730	0.759	0.788	0.815	0.841	0.867	0.892
TXR80036VK	50	0.309	0.356	0.398	0.435	0.470	0.502	0.532	0.561	0.614	0.663	0.708	0.751	0.791	0.829	0.866	0.901	0.935	0.967	0.999	1.03	1.06
TXR8004VK	50	0.347	0.400	0.447	0.489	0.528	0.564	0.598	0.630	0.690	0.745	0.796	0.843	0.889	0.932	0.973	1.01	1.05	1.09	1.12	1.16	1.19
TXR80049VK	50	0.423	0.488	0.545	0.597	0.644	0.688	0.730	0.769	0.842	0.909	0.971	1.03	1.09	1.14	1.19	1.24	1.28	1.33	1.37	1.41	1.45

Note: Always double check your application rates. Tabulations are based on spraying water at 70°F (21°C). See pages 136–157 for drop size classification, useful formulas and other information.

AITX ConeJet® Air Induction Hollow Cone Spray Tips



Typical Applications:

Hollow cone spray pattern is ideal for air blast and directed spray applications.

Features:

- Constructed of polypropylene, ceramic and Viton® for excellent chemical and wear resistance.
- Removable pre-orifice for fast and easy cleaning.
- Available in VisiFlo® ceramic (VK).
- Larger droplets are produced, as compared to standard TX ConeJet, through the use of a venturi air aspirator resulting in reduced drift and improved canopy penetration.

- Ideal for sprayers equipped with automatic control systems.
- AITXA to be used with CP25607-^{*}-NY Quick TeeJet cap.
- AITXB to be used with Albuz® caps or equivalent.
- Suggested spray pressure of 60–300 PSI (4–20 bar).

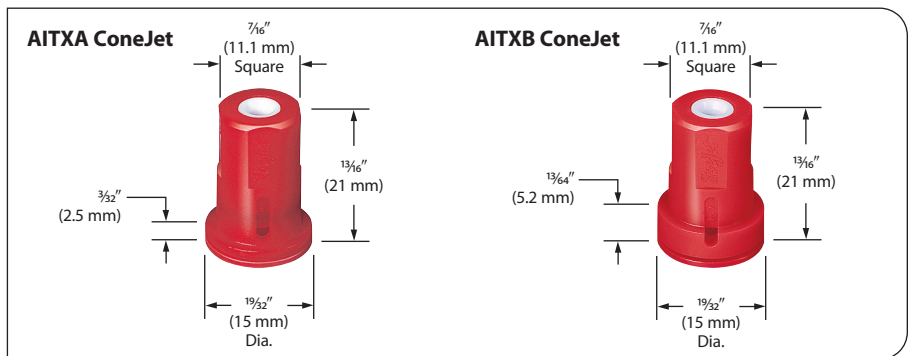

How to order:

Specify tip number.

Example:

AITXA8001VK – Ceramic with VisiFlo color-coding

Tip	GPM	GPM														
		60 PSI	70 PSI	80 PSI	90 PSI	100 PSI	120 PSI	140 PSI	160 PSI	180 PSI	200 PSI	220 PSI	240 PSI	260 PSI	280 PSI	300 PSI
AITX†8001VK	50	0.121	0.130	0.138	0.146	0.154	0.168	0.181	0.192	0.203	0.214	0.224	0.233	0.242	0.251	0.260
		XC	XC	VC	VC	VC	C	C	C	C	C	C	C	M	M	M
AITX†80015VK	50	0.181	0.195	0.209	0.221	0.233	0.255	0.275	0.294	0.312	0.328	0.344	0.359	0.374	0.388	0.401
		XC	XC	XC	VC	VC	C	C	C	C	C	C	C	M	M	M
AITX†8002VK	50	0.247	0.195	0.286	0.303	0.320	0.351	0.379	0.405	0.430	0.453	0.476	0.497	0.517	0.537	0.556
		XC	XC	XC	XC	XC	VC	VC	VC	VC	C	C	C	C	C	C
AITX†80025VK	50	0.300	0.324	0.347	0.368	0.387	0.424	0.458	0.490	0.519	0.548	0.574	0.600	0.624	0.648	0.670
		UC	UC	XC	XC	XC	XC	XC	XC	VC	VC	VC	VC	VC	VC	VC
AITX†8003VK	50	0.360	0.389	0.417	0.443	0.467	0.513	0.554	0.594	0.630	0.665	0.698	0.730	0.760	0.790	0.818
		UC	UC	XC	XC	XC	XC	XC	VC	VC	VC	VC	VC	C	C	C
AITX†8004VK	50	0.480	0.519	0.556	0.590	0.623	0.684	0.740	0.792	0.841	0.887	0.931	0.974	1.01	1.05	1.09
		UC	UC	UC	UC	XC	XC	XC	XC	XC	VC	VC	VC	VC	VC	VC

†Specify "A" or "B." **Note:** Always double check your application rates. Tabulations are based on spraying water at 70°F (21°C). See pages 136–157 for drop size classification, useful formulas and other information.



ConeJet® VisiFlo® Hollow Cone Spray Tips

Typical Assembly

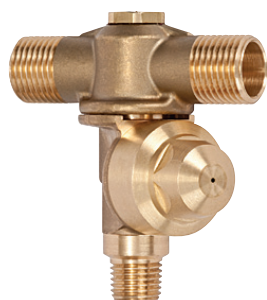

4514-NY
Slotted Strainer*



Core



Disc



CP20230
TeeJet Cap

*Use CP20229-NY gasket when 4514-NY Nylon slotted strainer is not used.

98450 Double Outlet Rollover

For a complete listing of rollover options, please see page 70.



TeeJet® VisiFlo Flat Spray Tips



Typical Applications:

Excellent: Use for directed applications in air blast spraying for orchards and vineyards and other specialty crops. Also well-suited for applications of insecticides, fungicides, defoliant and foliar fertilizers at pressures of 40 PSI (3 bar) and above.

Features:

- Tapered-edge flat spray pattern for uniform coverage.
- VisiFlo color-coded version available with ceramic orifice.
- Maximum pressure rating of 300 PSI (20 bar).



		GPM																		
		30 PSI	40 PSI	50 PSI	60 PSI	70 PSI	80 PSI	90 PSI	100 PSI	120 PSI	140 PSI	160 PSI	180 PSI	200 PSI	220 PSI	240 PSI	260 PSI	280 PSI	300 PSI	
																				
TP8001VK	100	0.087	0.10	0.11	0.12	0.13	0.14	0.15	0.16	0.17	0.19	0.20	0.21	0.22	0.23	0.24	0.25	0.26	0.27	
TP80015VK	100	0.13	0.15	0.17	0.18	0.20	0.21	0.23	0.24	0.26	0.28	0.30	0.32	0.34	0.35	0.37	0.38	0.40	0.41	
TP8002VK	50	0.17	0.20	0.22	0.24	0.26	0.28	0.30	0.32	0.35	0.37	0.40	0.42	0.45	0.47	0.49	0.51	0.53	0.55	
XR8003VK	50	0.26	0.30	0.34	0.37	0.40	0.42	0.45	0.47	0.52	0.56	0.60	0.64	0.67	0.70	0.73	0.76	0.79	0.82	
XR8004VK	50	0.35	0.40	0.45	0.49	0.53	0.57	0.60	0.63	0.69	0.75	0.80	0.85	0.89	0.94	0.98	1.02	1.06	1.10	
XR8005VK	50	0.43	0.50	0.56	0.61	0.66	0.71	0.75	0.79	0.87	0.94	1.00	1.06	1.12	1.17	1.22	1.27	1.32	1.37	
XR8006VK	50	0.52	0.60	0.67	0.73	0.79	0.85	0.90	0.95	1.04	1.12	1.20	1.27	1.34	1.41	1.47	1.53	1.59	1.64	
XR8008VK	50	0.69	0.80	0.89	0.98	1.06	1.13	1.20	1.26	1.39	1.50	1.60	1.70	1.79	1.88	1.96	2.04	2.12	2.19	

Note: Always double check your application rates. Tabulations are based on spraying water at 70°F (21°C). See pages 136–157 for useful formulas and other information.



Typical Assembly with Ceramic Disc and Core



Hollow Cone Spray Pattern
Produced by Cores #13, 23, 25, 45 & 46

*Use CP20229-NY gasket when 4514-NY Nylon slotted strainer is not used.

Hollow Cone Type Spray Tips

			GPM													
			10 PSI	20 PSI	30 PSI	40 PSI	60 PSI	80 PSI	100 PSI	150 PSI	200 PSI	300 PSI	20 PSI	40 PSI	80 PSI	
D1	DC13	.031"	—	—	.059	.066	.078	.088	.097	.115	.128	.152	—	51°	62°	
D1.5	DC13	.036"	—	.057	.067	.075	.088	.098	.110	.127	.142	.167	38°	55°	66°	
D2	DC13	.041"	—	.064	.075	.08	.10	.11	.12	.14	.16	.18	49°	67°	72°	
D3	DC13	.047"	—	.071	.08	.09	.11	.12	.13	.16	.18	.20	53°	70°	75°	
D4	DC13	.063"	.070	.09	.11	.12	.14	.16	.17	.20	.23	.27	69°	79°	83°	
D1	DC23	.031"	—	—	.064	.072	.080	.096	.107	.124	.139	.164	—	47°	58°	
D1.5	DC23	.036"	—	.064	.076	.086	.103	.117	.130	.155	.175	.210	34°	51°	62°	
D2	DC23	.041"	—	.078	.092	.10	.13	.14	.16	.19	.21	.25	51°	63°	70°	
D3	DC23	.047"	.065	.087	.10	.12	.14	.16	.18	.21	.24	.28	58°	69°	75°	
D4	DC23	.063"	.082	.113	.14	.15	.19	.21	.23	.28	.32	.38	68°	82°	87°	
D5	DC23	.078"	.095	.13	.16	.18	.22	.25	.28	.34	.38	.46	79°	89°	94°	
D6	DC23	.094"	.112	.15	.19	.21	.26	.29	.32	.39	.45	.54	84°	93°	98°	
D1	DC25	.031"	—	—	.088	.101	.122	.138	.156	.185	.210	.255	—	27°	43°	
D1.5	DC25	.036"	—	—	.118	.135	.162	.185	.205	.245	.280	.33	—	38°	49°	
D2	DC25	.041"	—	.12	.14	.16	.19	.22	.25	.29	.34	.41	39°	51°	58°	
D3	DC25	.047"	.10	.14	.17	.19	.23	.26	.29	.35	.40	.48	52°	61°	67°	
D4	DC25	.063"	.15	.21	.25	.29	.35	.40	.45	.54	.62	.75	67°	74°	80°	
D5	DC25	.078"	.18	.25	.30	.35	.42	.48	.54	.65	.75	.90	73°	79°	84°	
D6	DC25	.094"	.23	.32	.39	.44	.54	.62	.70	.85	.97	1.19	79°	85°	89°	
D7	DC25	.109"	.26	.37	.45	.52	.63	.73	.81	.98	1.18	1.37	85°	91°	93°	
D8	DC25	.125"	.31	.43	.53	.61	.75	.89	.97	1.19	1.36	1.68	91°	96°	97°	
D10	DC25	.156"	.38	.54	.65	.76	.93	1.07	1.21	1.48	1.71	2.1	97°	102°	103°	
D12	DC25	.188"	.46	.61	.80	.93	1.15	1.32	1.47	1.81	2.09	2.55	103°	109°	112°	
D14	DC25	.219"	.51	.72	.88	1.03	1.26	1.47	1.65	2.02	2.34	2.89	108°	113°	114°	
D1	DC45	.031"	—	—	—	.125	.148	.170	.190	.225	.257	.310	—	22°	34°	
D1.5	DC45	.036"	—	—	.14	.16	.20	.23	.25	.31	.35	.43	—	33°	44°	
D2	DC45	.041"	—	.14	.18	.20	.25	.28	.32	.38	.44	.53	32°	46°	55°	
D3	DC45	.047"	—	.17	.20	.23	.28	.33	.36	.44	.51	.62	40°	53°	60°	
D4	DC45	.063"	.18	.25	.31	.36	.43	.50	.56	.68	.78	.95	62°	69°	72°	
D5	DC45	.078"	.23	.32	.39	.45	.55	.64	.71	.86	.99	1.22	67°	73°	76°	
D6	DC45	.094"	.29	.41	.50	.58	.72	.83	.93	1.15	1.33	1.64	73°	79°	81°	
D7	DC45	.109"	.33	.48	.59	.68	.84	.97	1.11	1.35	1.57	1.94	81°	86°	87°	
D8	DC45	.125"	.41	.59	.72	.84	1.04	1.21	1.35	1.68	1.94	2.40	86°	90°	90°	
D10	DC45	.156"	.54	.77	.94	1.10	1.35	1.57	1.77	2.18	2.50	3.10	90°	93°	93°	
D12	DC45	.188"	.67	.95	1.17	1.36	1.68	1.95	2.20	2.69	3.11	3.80	97°	100°	102°	
D14	DC45	.218"	.75	1.07	1.32	1.53	1.89	2.19	2.45	3.00	3.49	4.30	101°	104°	105°	
D16	DC45	.250"	.86	1.25	1.54	1.79	2.20	2.57	2.89	3.54	4.11	5.20	108°	111°	112°	
D1	DC46	.031"	—	—	—	.145	.178	.205	.23	.28	.32	.39	—	13°	15°	
D1.5	DC46	.036"	—	—	—	.213	.260	.300	.33	.41	.46	.56	—	15°	17°	
D2	DC46	.041"	—	—	.24	.27	.33	.37	.42	.50	.57	.68	—	18°	21°	
D3	DC46	.047"	—	.23	.28	.32	.39	.45	.51	.61	.70	.86	14°	20°	24°	
D4	DC46	.063"	.28	.39	.48	.56	.68	.78	.88	1.07	1.23	1.52	23°	29°	33°	
D5	DC46	.078"	.38	.54	.66	.77	.94	1.10	1.25	1.50	1.73	2.13	33°	39°	42°	
D6	DC46	.094"	.55	.78	.95	1.10	1.35	1.58	1.73	2.16	2.50	3.06	42°	48°	50°	
D7	DC46	.109"	—	.98	1.22	1.39	1.72	1.97	2.22	2.73	3.15	3.85	48°	53°	56°	
D8	DC46	.125"	—	—	1.59	1.84	2.25	2.62	2.93	3.60	4.17	5.05	—	60°	62°	
D10	DC46	.156"	—	—	2.15	2.48	3.05	3.53	3.96	4.83	5.59	6.80	—	66°	68°	



CP26277-1-NY Quick TeeJet® Cap

For ceramic disc and core.
See page 64 for ordering information.

How to order:

To order orifice disc only, specify disc number and material.

Note: For proper assembly and performance, disc and core must both be of like materials.

Examples:

- DCER-2 – Ceramic
- D2 – Hardened Stainless Steel
- DE-2 – Stainless Steel
- DVP-2 – Polymer

To order core only, specify core number and material.

Examples:

- DC13-CER – Ceramic
- DC13-HSS – Hardened Stainless Steel
- DC13 – Brass
- DC13-NY – Nylon

STRAINER NOTE: For nozzles using orifice disc numbers 1, 1.5 and 2, or core numbers 31 and 33, slotted strainer number 4514-20 equivalent to 25 mesh screen size is required. For all other larger capacity discs and cores, slotted strainer number 4514-32 equivalent to 16 mesh screen size is required.

Note: Always double check your application rates. Tabulations are based on spraying water at 70°F (21°C). See pages 136–157 for useful formulas and other information.



TeeJet® Disc-Core Type Full Cone Spray Tips

Typical Applications:

For spraying pesticides at higher pressures and flow rates. Especially suitable for wettable powders and other abrasive chemicals. Larger capacity nozzles are also used in air blast sprayers.

Features:

- Produce smaller droplets for thorough coverage with contact pesticides and foliar applications.
- Maximum spray pressure to 300 PSI (20 bar).

Orifice Discs

Available in a variety of sizes and materials. Ceramic for increased wear life, hardened stainless steel, stainless steel and polymer.



Ceramic



Hardened Stainless Steel



Stainless Steel



Polymer

Cores

Standard cores are made of brass. Also available in ceramic, hardened stainless steel and Nylon. All cores with the exception of ceramic are made with rear "nibs." Make sure core is always placed with the nib facing the nozzle body.

Ceramic Sizes Available:

DC13-CER, DC23-CER, DC25-CER, DC31-CER, DC33-CER, DC35-CER, DC45-CER, DC46-CER, DC56-CER.



Ceramic



Hardened Stainless Steel



Brass



Nylon



CP18999



Seal

Full Cone Spray Pattern
Produced by Cores #31, 33, 35 & 56



Full Cone Type Spray Tips

Disc	Core	Orifice Size	GPM												Spray Angle		
			10 PSI	20 PSI	30 PSI	40 PSI	60 PSI	80 PSI	100 PSI	150 PSI	200 PSI	300 PSI	20 PSI	40 PSI	80 PSI		
D1	DC31	.031"	.08	.11	.13	.15	.18	.20	.23	.27	.31	.37	49°	47°	43°		
D1.5	DC31	.036"	.10	.14	.17	.19	.23	.26	.29	.35	.40	.48	57°	65°	53°		
D2	DC31	.041"	.12	.16	.19	.22	.26	.30	.33	.40	.45	.55	62°	63°	61°		
D3	DC31	.047"	.13	.18	.21	.24	.29	.33	.37	.44	.50	.60	63°	65°	63°		
D1	DC33	.031"	.09	.11	.12	.14	.17	.20	.22	.26	.30	.37	27°	32°	35°		
D1.5	DC33	.036"	.12	.15	.17	.19	.23	.26	.30	.36	.41	.50	37°	43°	45°		
D2	DC33	.041"	.13	.17	.21	.24	.29	.33	.37	.45	.52	.63	45°	52°	55°		
D3	DC33	.047"	.15	.21	.25	.29	.36	.41	.45	.55	.63	.76	48°	54°	57°		
D4	DC33	.063"	.20	.28	.34	.39	.47	.54	.60	.73	.83	1.02	50°	56°	61°		
D1	DC35	.031"	.08	.11	.13	.14	.17	.20	.22	.26	.29	.35	19°	23°	26°		
D1.5	DC35	.036"	.10	.14	.17	.19	.23	.26	.29	.34	.39	.46	23°	27°	29°		
D2	DC35	.041"	.14	.18	.24	.25	.30	.34	.37	.45	.51	.60	40°	44°	47°		
D3	DC35	.047"	.16	.22	.26	.30	.36	.41	.45	.55	.62	.74	45°	50°	52°		
D4	DC35	.063"	.27	.37	.44	.50	.60	.70	.79	.93	1.1	1.3	68°	70°	71°		
D5	DC35	.078"	.34	.48	.58	.66	.80	.92	1.0	1.2	1.4	1.7	67°	69°	71°		
D2	DC56	.041"	—	—	.21	.25	.30	.35	.39	.47	.55	.67	—	14°	17°		
D3	DC56	.047"	—	—	.29	.34	.41	.48	.53	.65	.75	.92	—	20°	23°		
D4	DC56	.063"	—	.39	.48	.55	.67	.78	.87	1.06	1.23	1.51	20°	26°	29°		
D5	DC56	.078"	.38	.54	.66	.76	.93	1.08	1.20	1.47	1.69	2.08	26°	32°	34°		
D6	DC56	.094"	.55	.78	.95	1.10	1.35	1.55	1.74	2.13	2.46	3.02	34°	39°	41°		
D7	DC56	.109"	.76	1.07	1.32	1.52	1.86	2.15	2.40	2.94	3.40	4.16	45°	52°	54°		
D8	DC56	.125"	.96	1.36	1.67	1.93	2.36	2.73	3.05	3.73	4.32	5.28	52°	57°	59°		
D10	DC56	.156"	1.35	1.91	2.34	2.70	3.31	3.82	4.26	5.22	6.03	7.39	62°	65°	67°		

Note: Always double check your application rates. Tabulations are based on spraying water at 70°F (21°C). See pages 136-157 for useful formulas and other information.

How to order:

To order orifice disc only, specify disc number and material. Note: For proper assembly and performance, disc and core must both be of like materials.

Examples:

- DCER-2 – Ceramic
- D2 – Hardened Stainless Steel
- DE-2 – Stainless Steel
- DVP-2 – Polymer

To order core only, specify core number and material.

Examples:

- DC13-CER – Ceramic
- DC13-HSS – Hardened Stainless Steel
- DC13 – Brass
- DC13-NY – Nylon
- CP18999-EPR Seal Gasket

STRAINER NOTE: For nozzles using orifice disc numbers 1, 1.5 and 2; or core numbers 31 and 33, slotted strainer number 4514-20 equivalent to 25 mesh screen size is required. For all other larger capacity discs and cores, slotted strainer number 4514-32 equivalent to 16 mesh screen size is required.

StreamJet SJ3 Fertilizer Nozzles



Typical Applications:

- Excellent for application of liquid fertilizer on bare ground or in standing crop.
- 3-stream pattern is ideal for directed application.

Features:

- VisiFlo® color-coding system.
- Three solid streams of equal velocity and capacity.
- Removable metering orifice for easy cleaning.
- Ten sizes for a wide range of application rates.

- Equally spaced distribution at 20" (50 cm) height.
- Use with Quick TeeJet® cap 25598*-NYR.
- All acetal construction for excellent chemical resistance.
- See page 141 for liquid density conversion factors.
- Recommended operating pressure: 20–60 PSI (1.5–4 bar).
- Solid stream pattern minimizes leaf burn and virtually eliminates drift.

Optimum Spray Height

20"	20"
30"	30"
40"	40"



How to order:

Specify tip number.

Example:
SJ3-03-VP – Polymer with VisiFlo color-coding

Nozzle Model	PSI	CAPACITY ONE NOZZLE IN GPM	GPA 20"										
			3 MPH	4 MPH	5 MPH	6 MPH	8 MPH	10 MPH	12 MPH	14 MPH	16 MPH	18 MPH	20 MPH
SJ3-015-VP (100)	20	0.11	10.9	8.2	6.5	5.4	4.1	3.3	2.7	2.3	2.0	1.8	1.6
	30	0.13	12.9	9.7	7.7	6.4	4.8	3.9	3.2	2.8	2.4	2.1	1.9
	40	0.15	14.9	11.1	8.9	7.4	5.6	4.5	3.7	3.2	2.8	2.5	2.2
	50	0.16	15.8	11.9	9.5	7.9	5.9	4.8	4.0	3.4	3.0	2.6	2.4
	60	0.17	16.8	12.6	10.1	8.4	6.3	5.0	4.2	3.6	3.2	2.8	2.5
SJ3-02-VP (50)	20	0.14	13.9	10.4	8.3	6.9	5.2	4.2	3.5	3.0	2.6	2.3	2.1
	30	0.17	16.8	12.6	10.1	8.4	6.3	5.0	4.2	3.6	3.2	2.8	2.5
	40	0.20	19.8	14.9	11.9	9.9	7.4	5.9	5.0	4.2	3.7	3.3	3.0
	50	0.21	21	15.6	12.5	10.4	7.8	6.2	5.2	4.5	3.9	3.5	3.1
	60	0.22	22	16.3	13.1	10.9	8.2	6.5	5.4	4.7	4.1	3.6	3.3
SJ3-03-VP (50)	20	0.24	24	17.8	14.3	11.9	8.9	7.1	5.9	5.1	4.5	4.0	3.6
	30	0.27	27	20	16.0	13.4	10.0	8.0	6.7	5.7	5.0	4.5	4.0
	40	0.30	30	22	17.8	14.9	11.1	8.9	7.4	6.4	5.6	5.0	4.5
	50	0.33	33	25	19.6	16.3	12.3	9.8	8.2	7.0	6.1	5.4	4.9
	60	0.35	35	26	21	17.3	13.0	10.4	8.7	7.4	6.5	5.8	5.2
SJ3-04-VP (50)	20	0.30	30	22	17.8	14.9	11.1	8.9	7.4	6.4	5.6	5.0	4.5
	30	0.36	36	27	21	17.8	13.4	10.7	8.9	7.6	6.7	5.9	5.3
	40	0.40	40	30	24	19.8	14.9	11.9	9.9	8.5	7.4	6.6	5.9
	50	0.43	43	32	26	21	16.0	12.8	10.6	9.1	8.0	7.1	6.4
	60	0.47	47	35	28	23	17.4	14.0	11.6	10.0	8.7	7.8	7.0
SJ3-05-VP (50)	20	0.36	36	27	21	17.8	13.4	10.7	8.9	7.6	6.7	5.9	5.3
	30	0.45	45	33	27	22	16.7	13.4	11.1	9.5	8.4	7.4	6.7
	40	0.50	50	37	30	25	18.6	14.9	12.4	10.6	9.3	8.3	7.4
	50	0.55	54	41	33	27	20	16.3	13.6	11.7	10.2	9.1	8.2
	60	0.59	58	44	35	29	22	17.5	14.6	12.5	11.0	9.7	8.8
SJ3-06-VP (50)	20	0.42	42	31	25	21	15.6	12.5	10.4	8.9	7.8	6.9	6.2
	30	0.54	53	40	32	27	20	16.0	13.4	11.5	10.0	8.9	8.0
	40	0.60	59	45	36	30	22	17.8	14.9	12.7	11.1	9.9	8.9
	50	0.66	65	49	39	33	25	19.6	16.3	14.0	12.3	10.9	9.8
	60	0.70	69	52	42	35	26	21	17.3	14.9	13.0	11.6	10.4
SJ3-08-VP	20	0.56	55	42	33	28	21	16.6	13.9	11.9	10.4	9.2	8.3
	30	0.72	71	53	43	36	27	21	17.8	15.3	13.4	11.9	10.7
	40	0.80	79	59	48	40	30	24	19.8	17.0	14.9	13.2	11.9
	50	0.88	87	65	52	44	33	26	22	18.7	16.3	14.5	13.1
	60	0.94	93	70	56	47	35	28	23	19.9	17.4	15.5	14.0
SJ3-10-VP	20	0.65	64	48	39	32	24	19.3	16.1	13.8	12.1	10.7	9.7
	30	0.90	89	67	53	45	33	27	22	19.1	16.7	14.9	13.4
	40	1.00	99	74	59	50	37	30	25	21	18.6	16.5	14.9
	50	1.11	110	82	66	55	41	33	27	24	21	18.3	16.5
	60	1.19	118	88	71	59	44	35	29	25	22	19.6	17.7
SJ3-15-VP	20	0.99	98	74	59	49	37	29	25	21	18.4	16.3	14.7
	30	1.24	123	92	74	61	46	37	31	26	23	20	18.4
	40	1.50	149	111	89	74	56	45	37	32	28	25	22
	50	1.68	166	125	100	83	62	50	42	36	31	28	25
	60	1.83	181	136	109	91	68	54	45	39	34	30	27
SJ3-20-VP	20	1.41	140	105	84	70	52	42	35	30	26	23	21
	30	1.75	173	130	104	87	65	52	43	37	32	29	26
	40	2.00	198	149	119	99	74	59	50	42	37	33	30
	50	2.28	226	169	135	113	85	68	56	48	42	38	34
	60	2.49	247	185	148	123	92	74	62	53	46	41	37

Note: Always double check your application rates. Tabulations are based on spraying water at 70°F (21°C). See pages 136–157 for useful formulas and other information.



StreamJet SJ7 Fertilizer Nozzles

Typical Application:

- Excellent for application of liquid fertilizer on bare ground or in standing crop.
- 7-stream pattern is ideal for broadcast application.

Features:

- Creates seven identical fluid streams of equal velocity and capacity.
- Excellent spray distribution quality.

- Removable metering orifice for easy cleaning.
- Offered in a variety of sizes for a wide range of application rates.
- VisiFlo® color-coding for easy capacity identification.
- All acetal construction for excellent chemical resistance.
- Recommended operating pressure: 20–60 PSI (1.5–4 bar).
- Solid stream pattern minimizes leaf burn and virtually eliminates drift.

Optimum Spray Height

20"	20"
30"	30"
40"	40"

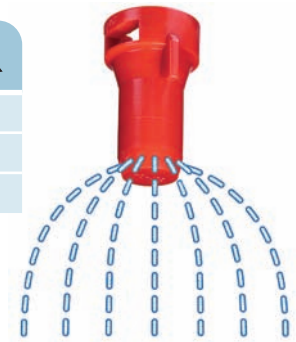

How to order:

Specify nozzle number.
Example: SJ7-04-VP



50854-NYB
Extension Adapter



Nozzle Model	PSI	CAPACITY ONE NOZZLE IN GPM	GPA										
			3 MPH	4 MPH	5 MPH	6 MPH	8 MPH	10 MPH	12 MPH	14 MPH	16 MPH	18 MPH	20 MPH
SJ7-015-VP (100)	20	0.10	9.9	7.4	5.9	5.0	3.7	3.0	2.5	2.1	1.9	1.7	1.5
	30	0.12	11.9	8.9	7.1	5.9	4.5	3.6	3.0	2.5	2.2	2.0	1.8
	40	0.15	14.9	11.1	8.9	7.4	5.6	4.5	3.7	3.2	2.8	2.5	2.2
	50	0.16	15.8	11.9	9.5	7.9	5.9	4.8	4.0	3.4	3.0	2.6	2.4
	60	0.18	17.8	13.4	10.7	8.9	6.7	5.3	4.5	3.8	3.3	3.0	2.7
SJ7-02-VP (50)	20	0.14	13.9	10.4	8.3	6.9	5.2	4.2	3.5	3.0	2.6	2.3	2.1
	30	0.17	16.8	12.6	10.1	8.4	6.3	5.0	4.2	3.6	3.2	2.8	2.5
	40	0.20	19.8	14.9	11.9	9.9	7.4	5.9	5.0	4.2	3.7	3.3	3.0
	50	0.23	23	17.1	13.7	11.4	8.5	6.8	5.7	4.9	4.3	3.8	3.4
	60	0.25	25	18.6	14.9	12.4	9.3	7.4	6.2	5.3	4.6	4.1	3.7
SJ7-03-VP (50)	20	0.22	22	16.3	13.1	10.9	8.2	6.5	5.4	4.7	4.1	3.6	3.3
	30	0.27	27	20	16.0	13.4	10.0	8.0	6.7	5.7	5.0	4.5	4.0
	40	0.30	30	22	17.8	14.9	11.1	8.9	7.4	6.4	5.6	5.0	4.5
	50	0.33	33	25	19.6	16.3	12.3	9.8	8.2	7.0	6.1	5.4	4.9
	60	0.35	35	26	21	17.3	13.0	10.4	8.7	7.4	6.5	5.8	5.2
SJ7-04-VP (50)	20	0.30	30	22	17.8	14.9	11.1	8.9	7.4	6.4	5.6	5.0	4.5
	30	0.35	35	26	21	17.3	13.0	10.4	8.7	7.4	6.5	5.8	5.2
	40	0.40	40	30	24	19.8	14.9	11.9	9.9	8.5	7.4	6.6	5.9
	50	0.43	43	32	26	21	16.0	12.8	10.6	9.1	8.0	7.1	6.4
	60	0.46	46	34	27	23	17.1	13.7	11.4	9.8	8.5	7.6	6.8
SJ7-05-VP (50)	20	0.38	38	28	23	18.8	14.1	11.3	9.4	8.1	7.1	6.3	5.6
	30	0.45	45	33	27	22	16.7	13.4	11.1	9.5	8.4	7.4	6.7
	40	0.50	50	37	30	25	18.6	14.9	12.4	10.6	9.3	8.3	7.4
	50	0.54	53	40	32	27	20	16.0	13.4	11.5	10.0	8.9	8.0
	60	0.58	57	43	34	29	22	17.2	14.4	12.3	10.8	9.6	8.6
SJ7-06-VP (50)	20	0.45	45	33	27	22	16.7	13.4	11.1	9.5	8.4	7.4	6.7
	30	0.54	53	40	32	27	20	16.0	13.4	11.5	10.0	8.9	8.0
	40	0.60	59	45	36	30	22	17.8	14.9	12.7	11.1	9.9	8.9
	50	0.65	64	48	39	32	24	19.3	16.1	13.8	12.1	10.7	9.7
	60	0.70	69	52	42	35	26	21	17.3	14.9	13.0	11.6	10.4
SJ7-08-VP	20	0.57	56	42	34	28	21	16.9	14.1	12.1	10.6	9.4	8.5
	30	0.72	71	53	43	36	27	21	17.8	15.3	13.4	11.9	10.7
	40	0.80	79	59	48	40	30	24	19.8	17.0	14.9	13.2	11.9
	50	0.87	86	65	52	43	32	26	22	18.5	16.1	14.4	12.9
	60	0.93	92	69	55	46	35	28	23	19.7	17.3	15.3	13.8
SJ7-10-VP	20	0.71	70	53	42	35	26	21	17.6	15.1	13.2	11.7	10.5
	30	0.90	89	67	53	45	33	27	22	19.1	16.7	14.9	13.4
	40	1.00	99	74	59	50	37	30	25	21	18.6	16.5	14.9
	50	1.09	108	81	65	54	40	32	27	23	20	18.0	16.2
	60	1.16	115	86	69	57	43	34	29	25	22	19.1	17.2
SJ7-15-VP	20	1.03	102	76	61	51	38	31	25	22	19.1	17.0	15.3
	30	1.29	128	96	77	64	48	38	32	27	24	21	19.2
	40	1.50	149	111	89	74	56	45	37	32	28	25	22
	50	1.64	162	122	97	81	61	49	41	35	30	27	24
	60	1.76	174	131	105	87	65	52	44	37	33	29	26

Note: Always double check your application rates. Tabulations are based on spraying water at 70°F (21°C). See pages 136–157 for useful formulas and other information.



Flow Regulators are usually mounted behind cultivator shanks for the subsurface application of liquid fertilizers and soil fumigants. They are also used for above-ground streaming applications.

How to order:

Specify orifice plate number.
Example: CP4916-008

Typical Assembly



Note: Always insert Orifice Plate with side marked with number facing the outlet.
MATERIAL: Stainless Steel

To determine the orifice plates you need, use the following equations:

$$\text{GPM (Per Nozzle)} = \frac{\text{GPA} \times \text{MPH} \times \text{W}}{5,940}$$

$$\text{GPA} = \frac{5,940 \times \text{GPM (Per Nozzle)}}{\text{MPH} \times \text{W}}$$

- W = Nozzle spacing (in inches) for broadcast spraying.
- = Spray width (in inches) for single nozzle, band spraying or boomless spraying.
- = Row spacing (in inches) divided by the number of nozzles per row for directed spraying.

Tip Strainer Size Recommendation

FOR ORIFICE SIZE	USE MESH SIZE
15 and smaller	200
16-39	100
40-70	50
72 and larger	—

Tabulated flow rates are for spraying water into air at atmospheric pressure. If your application creates backpressure, or if spraying into a liquid, measure and calibrate to ensure proper application rates. For spraying solutions other than water, see page 141 for conversion factors.

Orifice Size	GPM							
	5 PSI	10 PSI	20 PSI	30 PSI	40 PSI	50 PSI	60 PSI	
CP4916-008	0.003	0.004	0.006	0.007	0.008	0.009	0.010	
CP4916-10	0.005	0.007	0.009	0.011	0.013	0.015	0.016	
CP4916-12	0.007	0.010	0.013	0.016	0.019	0.021	0.023	
CP4916-14	0.009	0.013	0.018	0.022	0.025	0.028	0.031	
CP4916-15	0.010	0.015	0.021	0.025	0.029	0.032	0.036	
CP4916-16	0.012	0.017	0.023	0.029	0.033	0.037	0.040	
CP4916-18	0.015	0.021	0.030	0.036	0.042	0.047	0.051	
CP4916-20	0.018	0.026	0.037	0.045	0.052	0.058	0.064	
CP4916-22	0.022	0.031	0.043	0.053	0.061	0.068	0.075	
CP4916-24	0.026	0.037	0.052	0.064	0.074	0.083	0.091	
CP4916-25	0.028	0.040	0.056	0.068	0.079	0.088	0.097	
CP4916-26	0.030	0.043	0.061	0.074	0.086	0.096	0.105	
CP4916-27	0.032	0.046	0.064	0.079	0.091	0.102	0.111	
CP4916-28	0.035	0.049	0.069	0.085	0.098	0.110	0.120	
CP4916-29	0.038	0.054	0.076	0.094	0.108	0.121	0.132	
CP4916-30	0.040	0.057	0.081	0.099	0.114	0.127	0.140	
CP4916-31	0.043	0.062	0.087	0.107	0.123	0.138	0.151	
CP4916-32	0.048	0.068	0.095	0.117	0.135	0.151	0.165	
CP4916-34	0.052	0.074	0.104	0.127	0.147	0.164	0.180	
CP4916-35	0.056	0.079	0.111	0.136	0.157	0.176	0.192	
CP4916-37	0.061	0.086	0.122	0.149	0.172	0.192	0.211	
CP4916-39	0.068	0.096	0.135	0.165	0.191	0.214	0.234	
CP4916-40	0.072	0.102	0.144	0.177	0.204	0.228	0.250	
CP4916-41	0.075	0.106	0.149	0.183	0.211	0.236	0.258	
CP4916-43	0.082	0.116	0.163	0.200	0.231	0.258	0.283	
CP4916-45	0.088	0.125	0.177	0.217	0.250	0.280	0.306	
CP4916-46	0.095	0.135	0.191	0.234	0.270	0.302	0.331	

Orifice Size	GPM							
	5 PSI	10 PSI	20 PSI	30 PSI	40 PSI	50 PSI	60 PSI	
CP4916-47	0.097	0.138	0.194	0.238	0.275	0.307	0.337	
CP4916-48	0.101	0.143	0.202	0.248	0.286	0.320	0.350	
CP4916-49	0.104	0.148	0.209	0.255	0.295	0.330	0.361	
CP4916-51	0.116	0.165	0.233	0.285	0.329	0.368	0.403	
CP4916-52	0.118	0.168	0.237	0.290	0.335	0.375	0.410	
CP4916-54	0.127	0.180	0.255	0.312	0.360	0.402	0.441	
CP4916-55	0.133	0.189	0.267	0.326	0.377	0.421	0.462	
CP4916-57	0.141	0.200	0.283	0.346	0.400	0.447	0.490	
CP4916-59	0.153	0.217	0.306	0.375	0.433	0.484	0.530	
CP4916-61	0.165	0.233	0.330	0.404	0.466	0.521	0.571	
CP4916-63	0.174	0.246	0.347	0.425	0.491	0.549	0.601	
CP4916-65	0.185	0.261	0.369	0.452	0.522	0.584	0.639	
CP4916-67	0.196	0.278	0.392	0.481	0.555	0.621	0.680	
CP4916-68	0.203	0.287	0.405	0.496	0.573	0.641	0.702	
CP4916-70	0.216	0.306	0.433	0.530	0.612	0.684	0.750	
CP4916-72	0.226	0.320	0.453	0.554	0.640	0.716	0.784	
CP4916-73	0.233	0.330	0.467	0.572	0.660	0.738	0.808	
CP4916-75	0.245	0.347	0.491	0.601	0.694	0.776	0.850	
CP4916-78	0.272	0.385	0.544	0.667	0.770	0.861	0.943	
CP4916-80	0.280	0.397	0.561	0.687	0.793	0.887	0.971	
CP4916-81	0.290	0.411	0.581	0.711	0.821	0.918	1.01	
CP4916-83	0.317	0.449	0.634	0.777	0.897	1.00	1.10	
CP4916-86	0.332	0.470	0.664	0.813	0.939	1.05	1.15	
CP4916-89	0.346	0.490	0.693	0.849	0.980	1.10	1.20	
CP4916-91	0.369	0.523	0.739	0.905	1.05	1.17	1.28	
CP4916-93	0.387	0.547	0.774	0.947	1.09	1.22	1.34	
CP4916-95	0.404	0.572	0.808	0.990	1.14	1.28	1.40	

Orifice Size	GPM							
	5 PSI	10 PSI	20 PSI	30 PSI	40 PSI	50 PSI	60 PSI	
CP4916-98	0.442	0.625	0.884	1.08	1.25	1.40	1.53	
CP4916-103	0.461	0.653	0.923	1.13	1.31	1.46	1.60	
CP4916-107	0.518	0.733	1.04	1.27	1.47	1.64	1.79	
CP4916-110	0.548	0.775	1.10	1.34	1.55	1.73	1.90	
CP4916-115	0.605	0.855	1.21	1.48	1.71	1.91	2.09	
CP4916-120	0.629	0.890	1.26	1.54	1.78	1.99	2.18	
CP4916-125	0.693	0.980	1.39	1.70	1.96	2.19	2.40	
CP4916-128	0.721	1.02	1.44	1.77	2.04	2.28	2.50	
CP4916-132	0.774	1.10	1.55	1.90	2.19	2.45	2.68	
CP4916-136	0.840	1.19	1.68	2.06	2.38	2.66	2.91	
CP4916-140	0.894	1.27	1.79	2.19	2.53	2.83	3.10	
CP4916-144	0.926	1.31	1.85	2.27	2.62	2.93	3.21	
CP4916-147	0.953	1.35	1.91	2.33	2.70	3.01	3.30	
CP4916-151	1.04	1.47	2.08	2.55	2.94	3.29	3.60	
CP4916-156	1.10	1.55	2.20	2.69	3.11	3.47	3.80	
CP4916-161	1.15	1.63	2.31	2.83	3.27	3.65	4.00	
CP4916-166	1.21	1.72	2.43	2.97	3.43	3.84	4.20	
CP4916-170	1.30	1.84	2.61	3.19	3.69	4.12	4.51	
CP4916-172	1.36	1.92	2.71	3.32	3.84	4.29	4.70	
CP4916-177	1.41	2.00	2.83	3.46	4.00	4.47	4.90	
CP4916-182	1.47	2.08	2.95	3.61	4.17	4.66	5.10	
CP4916-187	1.56	2.21	3.12	3.82	4.41	4.93	5.40	
CP4916-196	1.73	2.45	3.46	4.24	4.90	5.47	6.00	
CP4916-205	1.88	2.65	3.75	4.59	5.31	5.93	6.50	
CP4916-218	2.11	2.98	4.21	5.16	5.96	6.66	7.30	
CP4916-234	2.45	3.47	4.91	6.01	6.94	7.76	8.50	
CP4916-250	2.83	4.00	5.66	6.93	8.00	8.94	9.80	

Note: Always double check your application rates. Tabulations are based on spraying water at 70°F (21°C). See pages 136-157 for useful formulas and other information.



StreamJet Solid Stream Spray Nozzles



Stainless Steel for Banding Fertilizers

- Permits banding fluids at high rig speeds.
- Large orifices with no internal obstructions permit non-clogging suspension applications.
- Lower drift potential.
- See page 141 for liquid density conversion factors.
- For TP tips use Quick TeeJet cap and gasket 25608-1-NYR.

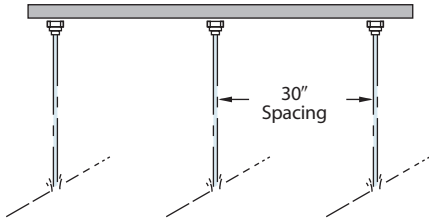

How to order:

Specify nozzle number and material.
Example: H1/4U-SS0010 Stainless Steel

Note: Always double check your application rates. Tabulations are based on spraying water at 70°F (21°C). See pages 136–157 for useful formulas and other information.

Nozzle Model	PSI	CAPACITY ONE NOZZLE IN GPM	GPA 30°								
			4 MPH	6 MPH	8 MPH	10 MPH	12 MPH	14 MPH	16 MPH	18 MPH	20 MPH
TP0001-SS	10	0.050	2.5	1.7	1.2	0.99	0.83	0.71	0.62	0.55	0.50
	20	0.071	3.5	2.3	1.8	1.4	1.2	1.0	0.88	0.78	0.70
	30	0.087	4.3	2.9	2.2	1.7	1.4	1.2	1.1	0.96	0.86
	40	0.10	5.0	3.3	2.5	2.0	1.7	1.4	1.2	1.1	0.99
TP00015-SS	10	0.075	3.7	2.5	1.9	1.5	1.2	1.1	0.93	0.83	0.74
	20	0.11	5.4	3.6	2.7	2.2	1.8	1.6	1.4	1.2	1.1
	30	0.13	6.4	4.3	3.2	2.6	2.1	1.8	1.6	1.4	1.3
	40	0.15	7.4	5.0	3.7	3.0	2.5	2.1	1.9	1.7	1.5
H1/4U-SS0002 TP0002-SS	10	0.10	5.0	3.3	2.5	2.0	1.7	1.4	1.2	1.1	0.99
	20	0.14	6.9	4.6	3.5	2.8	2.3	2.0	1.7	1.5	1.4
	30	0.17	8.4	5.6	4.2	3.4	2.8	2.4	2.1	1.9	1.7
	40	0.20	9.9	6.6	5.0	4.0	3.3	2.8	2.5	2.2	2.0
H1/4U-SS0003 TP0003-SS	10	0.15	7.4	5.0	3.7	3.0	2.5	2.1	1.9	1.7	1.5
	20	0.21	10.4	6.9	5.2	4.2	3.5	3.0	2.6	2.3	2.1
	30	0.26	12.9	8.6	6.4	5.1	4.3	3.7	3.2	2.9	2.6
	40	0.30	14.9	9.9	7.4	5.9	5.0	4.2	3.7	3.3	3.0
H1/4U-SS0004 TP0004-SS	10	0.20	9.9	6.6	5.0	4.0	3.3	2.8	2.5	2.2	2.0
	20	0.28	13.9	9.2	6.9	5.5	4.6	4.0	3.5	3.1	2.8
	30	0.35	17.3	11.6	8.7	6.9	5.8	5.0	4.3	3.9	3.5
	40	0.40	19.8	13.2	9.9	7.9	6.6	5.7	5.0	4.4	4.0
H1/4U-SS0006 TP0006-SS	10	0.30	14.9	9.9	7.4	5.9	5.0	4.2	3.7	3.3	3.0
	20	0.42	21	13.9	10.4	8.3	6.9	5.9	5.2	4.6	4.2
	30	0.52	26	17.2	12.9	10.3	8.6	7.4	6.4	5.7	5.1
	40	0.60	30	19.8	14.9	11.9	9.9	8.5	7.4	6.6	5.9
H1/4U-SS0008 TP0008-SS	10	0.40	19.8	13.2	9.9	7.9	6.6	5.7	5.0	4.4	4.0
	20	0.57	28	18.8	14.1	11.3	9.4	8.1	7.1	6.3	5.6
	30	0.69	34	23	17.1	13.7	11.4	9.8	8.5	7.6	6.8
	40	0.80	40	26	19.8	15.8	13.2	11.3	9.9	8.8	7.9
H1/4U-SS0010 TP0010-SS	10	0.50	25	16.5	12.4	9.9	8.3	7.1	6.2	5.5	5.0
	20	0.71	35	23	17.6	14.1	11.7	10.0	8.8	7.8	7.0
	30	0.87	43	29	22	17.2	14.4	12.3	10.8	9.6	8.6
	40	1.00	50	33	25	19.8	16.5	14.1	12.4	11.0	9.9
H1/4U-SS0015 TP0015-SS	10	0.75	37	25	19	14.9	12.4	10.6	9.3	8.3	7.4
	20	1.06	52	35	26	21	17.5	15.0	13.1	11.7	10.5
	30	1.30	64	43	32	26	21	18.4	16.1	14.3	12.9
	40	1.50	74	50	37	30	25	21	18.6	16.5	14.9
H1/4U-SS0020 TP0020-SS	10	1.00	50	33	25	19.8	16.5	14.1	12.4	11.0	9.9
	20	1.41	70	47	35	28	23	19.9	17.4	15.5	14.0
	30	1.73	86	57	43	34	29	24	21	19.0	17.1
	40	2.00	99	66	50	40	33	28	25	22	19.8
H1/4U-SS0030 TP0030-SS	10	1.50	74	50	37	30	25	21	18.6	16.5	14.9
	20	2.12	105	70	52	42	35	30	26	23	21
	30	2.60	129	86	64	51	43	37	32	29	26
	40	3.00	149	99	74	59	50	42	37	33	30
H1/4U-SS0040 TP0040-SS	10	2.00	99	66	50	40	33	28	25	22	20
	20	2.83	140	93	70	56	47	40	35	31	28
	30	3.46	171	114	86	69	57	49	43	38	34
	40	4.00	198	132	99	79	66	57	50	44	40
H1/4U-SS0050	10	2.50	124	83	62	50	41	35	31	28	25
	20	3.54	175	117	88	70	58	50	44	39	35
	30	4.33	214	143	107	86	71	61	54	48	43
	40	5.00	248	165	124	99	83	71	62	55	50
H1/4U-SS0060	10	3.00	149	99	74	59	50	42	37	33	30
	20	4.24	210	140	105	84	70	60	52	47	42
	30	5.20	257	172	129	103	86	74	64	57	51
	40	6.00	297	198	149	119	99	85	74	66	59





55270

- Rotating head driven by the flow of the rinsing liquid through multiple round spray orifices.
- Solid stream sprays are precisely positioned to provide effective internal wetting and cleaning of tank surface.
- Removable retainer and rotating body allows for disassembly and cleaning.
- Provides 360° coverage of inside surface of tank for tank diameters up to 10 feet (3.0 m).
- Self-lubricating and self-flushing design.



NOZZLE NUMBER	CAPACITY - GPM					TYPE OF COVERAGE	SPRAY ANGLE
	10 PSI	20 PSI	30 PSI	40 PSI	50 PSI		
55270-1/2-11-POM	5.9	7.9	9.4	11.0	12.4		360°
B55270-1/2-11-POM							
55270-3/4-18-POM	9.0	12.7	15.6	18.0	20.0		
B55270-3/4-18-POM							

- Materials: Body – black POM (acetal); Fasteners – stainless steel.
- Recommended operating pressure 10–50 PSI (0.7–3.5 bar).
- Mounting connection – ½" or ¾" NPT or BSPT (F).

Typical Application

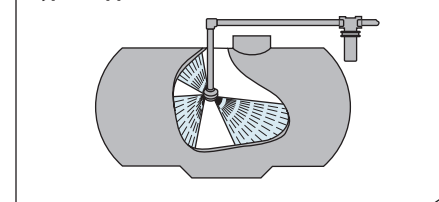

D41892

- The rotary tank rinsing nozzle is used for rinsing the insides of chemical containers and spray tanks up to 6.5' (2.0 m) in diameter.
- Available with ½" NPT or BSPT (F) connections.
- Significant lower rotating speed at approximately 15% of typical speed,



NOZZLE NUMBER	CAPACITY - GPM				
	20 PSI	30 PSI	40 PSI	50 PSI	60 PSI
D41892-(B)1/2-POM-6	4.0	4.9	5.7	6.4	7.0

- results in faster and more thorough cleaning of tank surface.
- Self-cleaning sliding bearing.
- Body and inserts are made of POM (Acetal).

- Nozzle fits in 1½" (37 mm) opening.
- Recommended operating pressure 30–60 PSI (2–4 bar) with a maximum pressure 115 PSI (8 bar).

TeeJet® Container Rinsing Nozzles

23240

- The 23240 container rinsing nozzle is used to rinse residue from containers before disposal.
- Can be used for containers with 1½" (26 mm) diameter openings or larger.
- Three flat spray orifices provide self-rotational forces needed to create spherical coverage.
- Available in ½" NPT or BSPT (F) connections.



NOZZLE NUMBER	INLET PIPE CONNECTION	CAPACITY - GPM				
		20 PSI	30 PSI	40 PSI	50 PSI	60 PSI
(B)23240-3-316SS-5.7-316SS	½" (F)	4.0	4.9	5.7	6.4	7.0
(B)23240-3-316SS-7-316SS		4.9	6.1	7.0	7.8	8.6

- Made of 316 stainless steel. HSS bearings and races have been replaced with 316SS bearings and races. Also includes an internal sleeve made of Nylon.

Typical Application

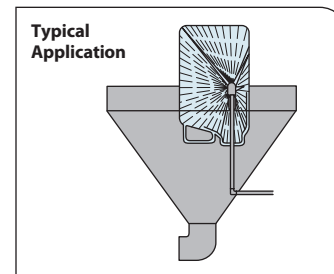

VSM

- Used for inside rinsing of chemical containers.
- 40 orifices combine to produce a 240° spray angle.
- All Nylon construction.
- Available with ½" or ¾" NPT or BSPT (F) connection.
- Recommended operating pressure 30–60 PSI (2–4 bar).



NOZZLE NUMBER	INLET PIPE CONNECTION	ORIFICE DIAMETER	CAPACITY - GPM						SPRAY ANGLE
			20 PSI	30 PSI	40 PSI	60 PSI	80 PSI	100 PSI	
(B) VSM-*-28	½" (F)	.031"	3.9	4.8	5.5	6.7	7.8	8.7	240°
(B) VSM-*-44		.039"	6.1	7.5	8.6	10.6	12.2	13.7	
(B) VSM-*-90	½" or ¾" (F)	.059"	12.5	15.3	17.7	22	25	28	
(B) VSM-*-140		.077"	19.4	24	27	34	39	43	
(B) VSM-*-190		.091"	26	32	37	46	53	59	

How to order:

(B) VSM – ¾ – 140
 | | | |
 BSPT Nozzle Type Size Capacity

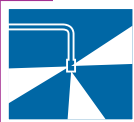

TeeJet® Educator Nozzles

46550, Y33180 & Y9270

Features:

- Allows small pumps to circulate large volumes of liquid.
- Manufactured of glass-filled polypropylene for excellent corrosion and chemical resistance.
- Large flow opening minimizes plugging.
- Available in 1/4", 3/8", 3/4" or 1 1/2" (M) pipe thread inlet connection.

How to order:

Specify nozzle number.
Example: Y33180-PP

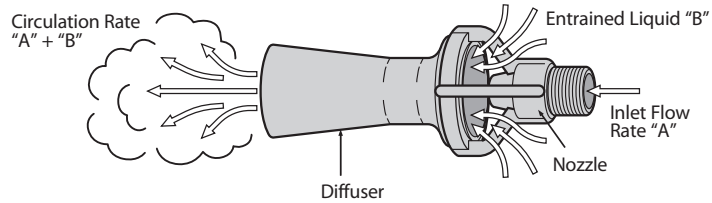
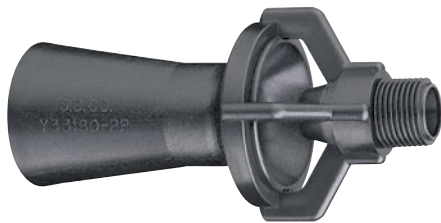

APPROXIMATE FLOW RATE PERFORMANCE	MODEL NUMBER	INLET LIQUID PRESSURE							
		10 PSI	15 PSI	20 PSI	25 PSI	30 PSI	35 PSI	40 PSI	50 PSI
Inlet Flow Rate "A" (GPM)	46550-1/4-PP	3.5	4.3	5.0	5.5	6.1	6.6	7.0	7.8
	Y33180-PP	9	11	12.7	14	16	17	18	20
	Y9270-PP	13.5	17	19	21	23	25	27	30
Entrained Liquid "B" (GPM)	46550-1-1/2-PP	33	40	47	53	58	63	66	75
	46550-1/4-PP	12.7	15.1	17.8	19.6	22	24	26	29
	Y33180-PP	36	44	50.8	56	64	68	72	80
Circulation Rate "A"+"B" (GPM)	Y9270-PP	54	68	76	84	92	100	108	120
	46550-1-1/2-PP	132	160	188	212	232	252	264	300
	46550-1/4-PP	16.2	19.4	22.8	25.1	28.1	30.6	33.0	36.8
Circulation Rate "A"+"B" (GPM)	Y33180-PP	45	55	63.5	70	80	85	90	100
	Y9270-PP	67.5	85	95	105	115	125	135	150
	46550-1-1/2-PP	165	200	235	265	290	315	330	375

MODEL NUMBER	PIPE THREAD INLET CONNECTION	ORIFICE DIAMETER	LENGTH	DIAMETER
46550-1/4-PP	1/4" (M)	3/16"	3"	1 1/4"
Y33180-PP	3/8" (M)	5/16"	4 1/8"	2 1/8"
Y9270-PP	3/4" (M)	3/8"	6 3/8"	2 9/32"
46550-1-1/2-PP	1 1/2" (M)	9/16"	10"	4 1/2"

TeeJet® Jet Agitators

Installed at bottom of spray tank on end of agitator return line. Continuous solid stream jet flow creates turbulence and keeps wettable powders in suspension.

6290-SC

Made in choice of brass, aluminum and all stainless steel. 1/4" NPT (F) inlet connection. Fits through 2" (51 mm) hole. Weight 6 oz. (0.17 kg). Siphon caps increase liquid flow by Venturi action to increase mixing potential.



JET AGITATOR NUMBER	ORIFICE CAP NUMBER	ORIFICE CAP INLET DIAMETER	CAPACITY (GPM) THRU AGITATOR LINE AT VARIOUS PRESSURES						FOR MAX. TANK SIZE IN GALLONS OF:
			10 PSI	15 PSI	20 PSI	30 PSI	40 PSI	50 PSI	
6290SC-1	11118-1	.055"	.78	.96	1.1	1.4	1.6	1.8	50
6290SC-2	11118-2	.086"	1.9	2.3	2.7	3.3	3.8	4.3	110
6290SC-3	11118-3	.096"	2.4	2.9	3.3	4.1	4.7	5.3	140
6290SC-5	11118-5	.144"	4.4	5.4	6.2	7.6	8.8	9.9	250
6290SC-8	11118-8	.156"	5.1	6.3	7.2	8.8	10.2	11.4	300
6290SC-10	11118-10	.177"	5.7	7.0	8.0	9.7	11.4	12.7	350

Note: Maximum tank sizes shown in table are approximate and are based on 40 PSI (3 bar) operation with pesticides, not fertilizers.

How to order:

Specify jet agitator number.

Examples:

- 6290SC-1 – Brass
- 6290SC-1-AL – Aluminum
- 6290SC-1-SS – Stainless Steel

Other sizes available.



QJ360C Nozzle Body Series for Dry Booms

- Available with either 3, 4 or 5 spray positions for easy change of spray tips or quick boom flushing.
 - Positive shutoff between each spray position.
 - Automatic spray alignment using flat fan spray tips.
 - Maximum operating pressure of 300 PSI (20 bar).
 - Available in ½", ¾" or 1" single or double hose shanks.
 - Includes ChemSaver® diaphragm check valve for drip-free shutoff. Standard diaphragm opens at 10 PSI (0.7 bar). See page 68 for additional 21950 ChemSaver spring capacities.
 - Standard EPDM diaphragm with Viton® available as an option.
 - Also available with optional Air ChemSaver or e-ChemSaver® shutoff valves, see page 69 for additional information.
 - Durable design mounts body high on boom structure for maximum protection.
- Flow Rate: 2.25 GPM (8.5 l/min) with 5 PSI (0.34 bar) pressure drop, 3.18 GPM (12.0 l/min) with 10 PSI (0.69 bar) pressure drop.
 - Molded hex socket in upper clamp for attaching to flat surfaces. Accepts ⅝" or M8 bolt.
 - Hinged upper clamp reduces assembly time and fits inside common boom channels.

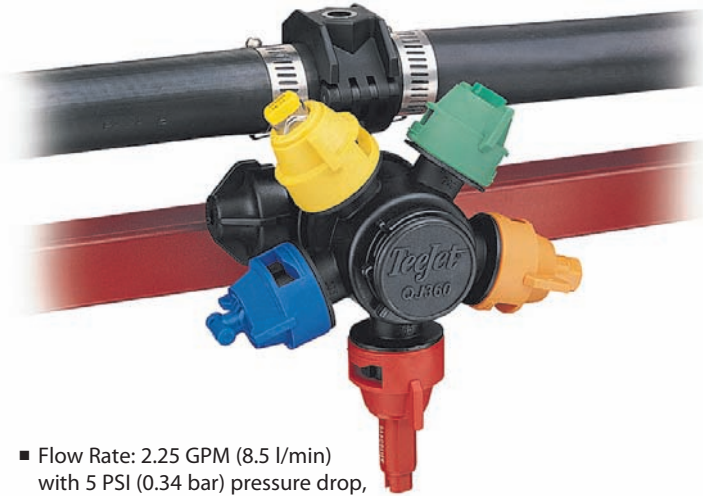

QJ363C

PART NUMBER		NUMBER OF SPRAY OUTLETS	TO FIT HOSE I.D.
SINGLE	DOUBLE		
QJ363C-500-1-NYB	QJ363C-500-2-NYB	3	½"
QJ363C-750-1-NYB	QJ363C-750-2-NYB	3	¾"
QJ363C-1000-1-NYB	QJ363C-1000-2-NYB	3	1"



QJ364C

PART NUMBER		NUMBER OF SPRAY OUTLETS	TO FIT HOSE I.D.
SINGLE	DOUBLE		
QJ364C-500-1-NYB	QJ364C-500-2-NYB	4	½"
QJ364C-750-1-NYB	QJ364C-750-2-NYB	4	¾"
QJ364C-1000-1-NYB	QJ364C-1000-2-NYB	4	1"



QJ365C

PART NUMBER		NUMBER OF SPRAY OUTLETS	TO FIT HOSE I.D.
SINGLE	DOUBLE		
QJ365C-500-1-NYB	QJ365C-500-2-NYB	5	½"
QJ365C-750-1-NYB	QJ365C-750-2-NYB	5	¾"
QJ365C-1000-1-NYB	QJ365C-1000-2-NYB	5	1"





Quick TeeJet®

Multiple Nozzle Body Assemblies with Fertilizer Outlets for Dry Booms

Features:

- Single fertilizer nozzle outlet with shutoff cap and either 3, 4, or 5 spray positions for easy change of spray tips or quick boom flushing.
- Positive shutoff between each position.
- Automatic self-alignment with flat fan spray patterns.
- Flow rate: pressure drop of 5 PSI (0.34 bar) for 2.25 GPM (8.5 l/min) through turret and 3.4 GPM (12.9 l/min) through fertilizer outlet.
- Flow rate: pressure drop of 10 PSI (0.69 bar) for 3.18 GPM (12.0 l/min) through turret and 4.8 GPM (18.2 l/min) through fertilizer outlet.
- Maximum pressure of 300 PSI (20 bar).
- Available in 1" single or double hose shanks.
- Includes ChemSaver diaphragm check valve for drip-free shutoff. Standard diaphragm opens at 10 PSI (0.7 bar). See page 68 for additional 21950 ChemSaver spring capacities.
- Standard O-rings and diaphragm made of EPDM and Buna with Viton optional.
- Molded hex socket in the upper clamp for attaching to flat surfaces (does not use dry boom clamp). Accepts 3/16" or M8 bolt.
- Also available with optional Air ChemSaver or e-ChemSaver® shutoff valves, see page 69 for additional information.
- Hinged upper clamp reduces assembly time and fits inside common boom channels.



PART NUMBER		NUMBER OF SPRAY OUTLETS	TO FIT HOSE I.D.
SINGLE	DOUBLE		
QJ363F-1000-1-NYB	QJ363F-1000-2-NYB	3 + 1	1"
QJ364F-1000-1-NYB	QJ364F-1000-2-NYB	4 + 1	
QJ365F-1000-1-NYB	QJ365F-1000-2-NYB	5 + 1	

Quick TeeJet® Single Nozzle Bodies for Dry Booms



QJ100 Series Quick TeeJet Nozzle Body

- Hose barb sizes for 3/8", 1/2" or 3/4" I.D. hose.
- Maximum operating pressure of 125 PSI (9 bar).

	PART NUMBER SINGLE	TO FIT HOSE I.D.
	18635-111-406-NYB	3/8"
18638-111-540-NYB	1/2"	
18719-111-785-NYB	3/4"	

	PART NUMBER DOUBLE	TO FIT HOSE I.D.
	18636-112-406-NYB	3/8"
18639-112-540-NYB	1/2"	
18720-112-785-NYB	3/4"	

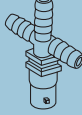
	PART NUMBER TRIPLE	TO FIT HOSE I.D.
	18637-113-406-NYB	3/8"
18640-113-540-NYB	1/2"	
18721-113-785-NYB	3/4"	



QJ200 Series Diaphragm Check Valve Quick TeeJet Nozzle Assemblies

- Available with single, double or triple hose shanks for 3/8", 1/2" and 3/4" I.D. hose.
- Drip-free shutoff with TeeJet ChemSaver®. Opens at 10 PSI (0.7 bar). Standard diaphragm is EPDM with Viton® optional.
- Maximum operating pressure of 125 PSI (9 bar).
- Flow rate: 2.25 GPM (8.5 l/min) at 5 PSI (0.34 bar) pressure drop, 3.18 GPM (12.0 l/min) at 10 PSI (0.69 bar) pressure drop.

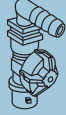
	PART NUMBER SINGLE	TO FIT HOSE I.D.
	19349-211-406-NYB	3/8"
19349-211-540-NYB	1/2"	
19349-211-785-NYB	3/4"	

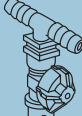
	PART NUMBER DOUBLE	TO FIT HOSE I.D.
	19350-212-406-NYB	3/8"
19350-212-540-NYB	1/2"	
19350-212-785-NYB	3/4"	

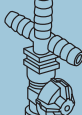
	PART NUMBER TRIPLE	TO FIT HOSE I.D.
	19351-213-406-NYB	3/8"
19351-213-540-NYB	1/2"	
19351-213-785-NYB	3/4"	



QJ300 Series Diaphragm Check Valve Quick TeeJet Nozzle Assemblies

- Low-profile design allows maximum protection against damage.
- Available with single and double hose shanks for 3/8", 1/2" and 3/4" I.D. hose.
- Drip-free shutoff with TeeJet ChemSaver®. Opens at 10 PSI (0.7 bar). Standard diaphragm is EPDM with Viton optional.
- Maximum operating pressure of 300 PSI (20 bar).
- Flow rate: 3.5 GPM (13.2 l/min) at 5 PSI (0.34 bar) pressure drop, 4.9 GPM (18.5 l/min) at 10 PSI (0.69 bar) pressure drop.

QJ300 Series is also available in polypropylene. Maximum operating pressure is 150 PSI (10 bar).

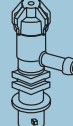
	PART NUMBER SINGLE	TO FIT HOSE I.D.
	22251-311-375-NYB	3/8"
22251-311-500-NYB	1/2"	
22251-311-750-NYB	3/4"	

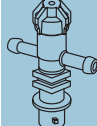
	PART NUMBER DOUBLE	TO FIT HOSE I.D.
	22252-312-375-NYB	3/8"
22252-312-500-NYB	1/2"	
22252-312-750-NYB	3/4"	

Note: See page 56 for vari-spacing clamps. See page 64 for Quick TeeJet caps.

QJ39685 Series Quick TeeJet Nozzle Body

Features:

- Use with Quick TeeJet caps.
- Hose shanks available in double or single (left or right) for 1/2" hose I.D.
- TeeJet ChemSaver drip-free shutoff.
- Made of corrosion-resistant materials.
- Maximum operating pressure of 300 PSI (20 bar).

- QJ39684 uses Nylon nut instead of brass nut.

Note: Support is normally supplied by the customer. TeeJet vari-spacing clamps AA111-* can be used. See page 73 for order information.



Single Left
QJ39685-1L-500-NYB



Double
QJ39685-2-500-NYB



Single Right
QJ39685-1R-500-NYB



TeeJet® Vari-Spacing Clamps for Use on Dry Boom Quick TeeJet Bodies

PART NUMBER (PLATED STEEL)	TO FIT
QJ111-1/2	1/2" Pipe (19/64" & 7/8" O.D. Tubings)
QJ111-3/4	3/4" Pipe (1" & 1 1/8" O.D. Tubings)
QJ111-1	1" Pipe (1 1/8", 1 1/4" & 1 3/8" O.D. Tubings)
QJ111-1-1/4	1 1/4" Pipe (1 5/8" & 1 7/8" O.D. Tubings)
QJ111HP-3/4	3/4" Pipe (1" & 1 1/8" O.D. Tubings)

PART NUMBER		TO FIT
PLATED STEEL	STAINLESS STEEL	
QJ111SQ-3/4	QJ111SQ-3/4-304SS	3/4" Square Tubing
QJ111SQ-1	QJ111SQ-1-304SS	1" Square Tubing
QJ111SQ-1 1/4	QJ111SQ-1 1/4-304SS	1 1/4" Square Tubing
QJ111SQ-1 1/2	QJ111SQ-1 1/2-304SS	1 1/2" Square Tubing

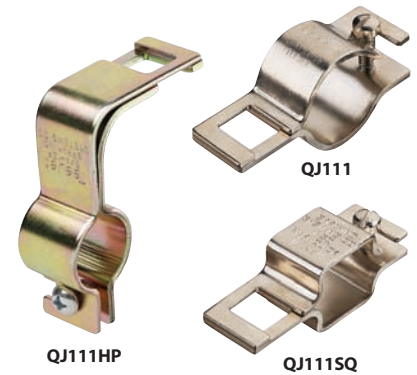

Quick TeeJet® Multiple Nozzle Body Assemblies

Triple Nozzle Body

- Designed to greatly simplify changing spray tips in the field.
- Provides three spray positions for easy change of spray tips or quick boom flushing.
- Positive shutoff between each spray position.
- Includes ChemSaver® diaphragm check valve for drip-free shutoff. Opens at 10 PSI (0.7 bar).
- Standard EPDM diaphragm with Viton® available as an option.
- Can be used with all Quick TeeJet caps.

- Nylon body.
- Maximum operating pressure of 125 PSI (9 bar).
- Available in 1/2" and 3/4" single, double or triple hose shanks.
- Flow Rate: 1.6 GPM (6.0 l/min) at 5 PSI (0.34 bar) pressure drop, 2.26 GPM (8.6 l/min) at 10 PSI (0.69 bar) pressure drop.

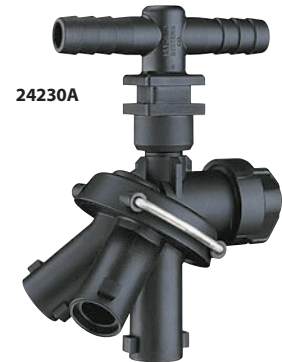

PART NUMBER			TO FIT HOSE
SINGLE	DOUBLE	TRIPLE	
24230A-1-540-NYB	24230A-2-540-NYB	24230A-3-540-NYB	1/2"
24230A-1-785-NYB	24230A-2-785-NYB	24230A-3-785-NYB	3/4"



Quick TeeJet® Multiple Nozzle Bodies for Wet Booms

QC360 Quick TeeJet® Nozzle Body with Cam Lever Coupling Adapter

- Same features as QJ360C multiple nozzle bodies.
- Body designed to fit into standard cam lever couplings allowing for quick change to smaller capacity spray tips.
- Locating nib keeps body properly oriented in fitting.

- Flow Rate: 2.25 GPM (8.5 l/min) at 5 PSI (0.34 bar) pressure drop, 3.18 GPM (12.0 l/min) at 10 PSI (0.69 bar) pressure drop.
- 1.26" (32 mm) diameter tip body fits 3/4" cam lever coupling.

PART NUMBER	NUMBER OF SPRAY OUTLETS
QC363-NYB	3
QC364-NYB	4
QC365-NYB	5





QJ360C Nozzle Body Series for Wet Booms

- Available with either 3, 4 or 5 spray positions for easy change of spray tips or quick boom flushing.
- Positive shutoff between each position.
- Automatic spray alignment using flat fan spray tips.
- Maximum operating pressure of 300 PSI (20 bar).
- Available in 25 mm, ½", ¾" or 1" pipe connections.
- Includes ChemSaver® diaphragm check valve for drip-free shutoff. Standard diaphragm opens at 10 PSI (0.7 bar). See page 68 for additional 21950 ChemSaver spring capacities.
- Standard EPDM diaphragm with Viton® available as an option.
- Also available with optional Air ChemSaver or e-ChemSaver® shutoff valves, see page 69 for additional information.
- Flow Rate: 2.25 GPM (8.5 l/min) at 5 PSI (0.34 bar) pressure drop, 3.18 GPM (12.0 l/min) with 10 PSI (0.69 bar) pressure drop.
- Mounts to a ¾" (9.5 mm) hole drilled in pipe or tubing.
- Molded hex socket in upper clamp for attaching to flat surfaces. Accepts ⅝" or M8 bolt.
- Hinged upper clamp reduces assembly time and fits inside common boom channels.



QJ360E Nozzle Body Series for Wet Booms

- Available to fit 20 mm O.D. tubing only.
- Flow Rate: 1.5 GPM (5.7 l/min) at 5 PSI (0.34 bar) pressure drop, 2.1 GPM (8.0 l/min) with 10 PSI (0.69 bar) pressure drop.
- Reduced internal cavity to increase ChemSaver shut-off speed.
- Notched inlet tube allows for more complete boom drainage and reduces sediment buildup.



QJ363C
QJ363E



QJ364C
QJ364E



QJ365C
QJ365E

PART NUMBER	NUMBER OF SPRAY OUTLETS	TO CLAMP ON
QJ363E-20mm-NYB	3	20 mm Tubing
QJ363C-25mm-NYB	3	25 mm Tubing
QJ363C-1/2-NYB	3	½" Pipe
QJ363C-3/4-NYB	3	¾" Pipe
QJ363C-1-NYB	3	1" Pipe

PART NUMBER	NUMBER OF SPRAY OUTLETS	TO CLAMP ON
QJ364E-20mm-NYB	4	20 mm Tubing
QJ364C-25mm-NYB	4	25 mm Tubing
QJ364C-1/2-NYB	4	½" Pipe
QJ364C-3/4-NYB	4	¾" Pipe
QJ364C-1-NYB	4	1" Pipe

PART NUMBER	NUMBER OF SPRAY OUTLETS	TO CLAMP ON
QJ365E-20mm-NYB	5	20 mm Tubing
QJ365C-25mm-NYB	5	25 mm Tubing
QJ365C-1/2-NYB	5	½" Pipe
QJ365C-3/4-NYB	5	¾" Pipe
QJ365C-1-NYB	5	1" Pipe



Quick TeeJet® Triple Nozzle Bodies for Wet Booms



24216A-NYB

- Can be mounted to 20 mm, ½", ¾" or 1" pipe or equivalent size tubing.
- Provides three spray positions for easy change of spray tips.
- Shutoff position provided between each spray position.
- Features ChemSaver® drip-free shutoff. Requires 10 PSI (0.7 bar) at the nozzle to open check valve.
- Standard diaphragm of EPDM with optional Viton® available.
- Maximum operating pressure of 150 PSI (10 bar).
- ½" and ¾" sizes include mounting hole in upper clamp for attachment to flat surfaces.
- Mounts to a ⅜" (9.5 mm) or ⅝" (7.0 mm) hole drilled in pipe or tubing.
- Flow rate: 1.6 GPM (6.1 l/min) at 5 PSI (0.34 bar) pressure drop, 2.26 GPM (8.6 l/min) at 10 PSI (0.69 bar) pressure drop.

PART NUMBER	TO CLAMP ON	DRILL HOLE SIZE	UPPER CLAMP BOLT SIZE
24216A-20mm-NYB	20 mm Tubing	.375" (9.5 mm)	M8
24216A-20mmx7-NYB	20 mm Tubing	.280" (7.0 mm)	M8
24216A-1/2-NYB	½" Pipe	.375" (9.5 mm)	¼"
24216A-1/2x7-NYB	½" Pipe	.280" (7.0 mm)	¼"
24216A-1/2M-NYB	½" Pipe	.375" (9.5 mm)	M8
24216A-3/4-NYB	¾" Pipe	.375" (9.5 mm)	¼"
24216A-1-NYB	1" Pipe	.375" (9.5 mm)	N/A



Quick TeeJet® Multiple Nozzle Bodies with Fertilizer Outlets for Wet Booms

Features:

- Single fertilizer nozzle outlet with shutoff cap and either 3, 4 or 5 spray positions for easy change of spray tips or quick boom flushing.
- Positive shutoff between each position.
- Automatic self-alignment with flat fan spray patterns.
- Flow rate: 2.25 GPM (8.5 l/min) with 5 PSI (0.34 bar) pressure drop through turret and 3.4 GPM (12.9 l/min) through fertilizer outlet.
- Flow rate: 3.18 GPM (12.0 l/min) with 10 PSI (0.69 bar) pressure drop through turret and 4.8 GPM (18.2 l/min) through fertilizer outlet.
- Maximum pressure of 300 PSI (20 bar).
- Available in 1" pipe connections and mounts with a ⅜" (9.5 mm) hole drilled in pipe or tubing.
- Includes ChemSaver® diaphragm check valve for drip-free shutoff. Standard diaphragm opens at 10 PSI (0.7 bar). See page 60 for additional 21950 ChemSaver spring capacities.
- Standard O-rings and diaphragm made of EPDM and Buna with Viton® optional.
- Also available with optional Air ChemSaver or e-ChemSaver® shutoff valves, see page 69 for additional information.
- Molded hex socket in the upper clamp for attaching to flat surfaces. Accepts ⅝" or M8 bolt.
- Hinged upper clamp reduces assembly time and fits inside common boom channels.



QJ363F



QJ364F



QJ365F

PART NUMBER	NUMBER OF SPRAY OUTLETS	TO CLAMP ON
QJ363F-1-NYB	3 + 1	1" Pipe
QJ364F-1-NYB	4 + 1	1" Pipe
QJ365F-1-NYB	5 + 1	1" Pipe



QJ380 High Flow Nozzle Body

- High capacity multiple outlet nozzle body is ideal for high speed, high volume applications including liquid fertilizer.
- Available with 3 spray positions for easy change of spray tips or quick boom flushing.
- Positive shutoff between each spray position.
- Automatic spray alignment when using flat fan spray tips.
- Maximum operating pressure of 150 PSI (10 bar).
- Available in ¾" or 1" pipe size.
- Requires ⅜" (9.5 mm) hole drilled in pipe or tubing.
- Includes high capacity ChemSaver® diaphragm check valve for drip-free shutoff. Diaphragm opens at 12 PSI (0.8 bar).
- 3.0 GPM (11.4 l/min) flow rate at a 5 PSI (0.34 bar) pressure drop.
- Molded hex socket in upper clamp for attaching to flat surfaces. Accepts ⅝" or M8 bolt.
- Hinged upper clamp reduces assembly time and fits inside common boom channels.
- Constructed of nylon and acetal with Viton® seals and O-rings.

PART NUMBER	NUMBER OF SPRAY OUTLETS	TO CLAMP ON
QJ383-3/4-NYB	3	¾" Pipe
QJ383-1-NYB	3	1" Pipe



QJ380

QJ380F High Flow Nozzle Body with Fertilizer Outlet

- Same features as standard QJ380, with an additional higher flow outlet on bottom of body.
- Additional outlet can be used for very high flow applications such as liquid fertilizer.
- Flow rate through fertilizer outlet is 4.5 GPM (17.0 l/min) at 5 PSI (0.34 bar) pressure drop.

PART NUMBER	NUMBER OF SPRAY OUTLETS	TO CLAMP ON
QJ383F-3/4-NYB	3 + 1	¾" Pipe
QJ383F-1-NYB	3 + 1	1" Pipe



QJ383F

CP98488-VI Hi-Flow Nozzle Body Adapter Insert

- Reduces ⅜" (9.5mm) hole to ⅝" (12.7mm).
- Allows QJ380 nozzle body to be used in place of non-TeeJet high-flow wet boom nozzle bodies.



CP98488-VI



Quick TeeJet® QJS Series Stackable Nozzle Bodies

The QJS nozzle body utilizes a modular design that allows for highly customized solutions to best fit your sprayer and spraying application needs. Choose the boom size, inlet position, outlet arrangement and tip shutoff mechanism that works best.

- Multiple outlet, stackable nozzle body is ideal for mounted, trailed and self-propelled sprayers.
- Wet boom configuration offered with choice of bottom or side inlet in five different boom diameters ($\frac{1}{2}$ ", $\frac{3}{4}$ ", 1", 20mm and 25mm); dry boom version also available in three sizes ($\frac{1}{2}$ ", $\frac{3}{4}$ ", 1").
- Can be equipped with any combination of TeeJet ChemSaver® tip shutoffs including pneumatic, electric, manual or spring-loaded check valve.
- Choose from one to four outlets in a variety of configurations.
- Wetted parts are nylon and Viton.
- Maximum operating pressure of up to 300 PSI (20 bar) depending on the ChemSaver used.
- Flow rating of up to 2.75 gpm (10.4 l/min) at 5 PSI (0.34 bar) pressure drop and 4.0 gpm (15.1 l/min) at 10 PSI (0.7 bar) pressure drop depending on ChemSaver used.
- See page 69 for additional info on ChemSaver shutoffs.



QJS-B3-AAA



QJS-B3-MAA



QJS-S2-EM



QJS-T4R-750-L-AAAA

OUTLET CONFIGURATION	
S0	Side Inlet, Stacked Bodies, Split Eyelet Only
S1	Side Inlet, Stacked Bodies, 1 Outlet
S2	Side Inlet, Stacked Bodies, 2 Outlets
B0	Side Inlet, Stacked Bodies, Split Eyelet Only with Plug
B1	Bottom Inlet, Stacked Bodies, 1 Outlet
B2	Bottom Inlet, Stacked Bodies, 2 Outlets
B3	Bottom Inlet, Stacked Bodies, 3 Outlets
T3	Bottom Inlet, Parallel Bodies, 3 Outlets Parallel to Boom
T4	Bottom Inlet, Parallel Bodies, 4 Outlets Including Outlet Below Boom
T4R	Bottom Inlet, Parallel Bodies, 4 Outlets Parallel to Boom, Additional Outlet on Right Side
T4L	Bottom Inlet, Parallel Bodies, 4 Outlets Parallel to Boom, Additional Outlet on Left Side

Note: Outlet orientation is viewed with split eyelet pointing forward.

PIPE/HOSE SIZE	
20 mm	20 mm Tubing
25 mm	25 mm Tubing
½	½" Pipe
¾	¾" Pipe
1	1" Pipe
500	½" Hose Barb
750	¾" Hose Barb
1000	1" Hose Barb

DRY BOOM ORIENTATION	
L	Single Hose Barb Left Orientation
R	Single Hose Barb Right Orientation
2	Double Hose Barb
Blank	Wet Boom

Note: Hose barb orientation is viewed with split eyelet pointing forward.

SHUTOFF TYPE FOR EACH POSITION	
C	Standard ChemSaver®
M	Manual ChemSaver
E	e-ChemSaver® (12 VDC)*
V	e-ChemSaver (24 VDC)*
A	Air ChemSaver
Blank	No ChemSaver

Note: First position of e-ChemSaver is location nearest to the pipe.

*Preferred position of e-ChemSaver is location nearest to the pipe.





QJ22187

QJ22187-NYB

- Can be mounted to 1/2", 3/4" or 1" pipe or equivalent size tubing.
- 1/2" and 3/4" sizes include a mounting hole in clamp subassembly for mounting to flat surfaces.
- Allows side mounting to flat surface for protection of nozzle body.
- Features ChemSaver drip-free shutoff. Requires 10 PSI (0.7 bar) at the nozzle to open check valve.
- Standard diaphragm of EPDM with optional Viton available.
- Mounts to a 3/8" (9.5 mm) hole drilled in pipe or tubing.
- Maximum operating pressure of 300 PSI (20 bar).
- Flow rate: 2.5 GPM (9.5 l/min) at 5 PSI (0.34 bar) pressure drop, 3.54 GPM (13.4 l/min) at 10 PSI (0.69 bar) pressure drop.

PART NUMBER	TO CLAMP ON	DRILL HOLE SIZE	UPPER CLAMP BOLT SIZE
QJ22187-1/2-NYB	1/2" Pipe	.375" (9.5 mm)	1/4"
QJ22187-3/4-NYB	3/4" Pipe	.375" (9.5 mm)	1/4"
QJ22187-1-NYB	1" Pipe	.375" (9.5 mm)	N/A



QJ17560A

QJ17560A-NYB

- Can be mounted to 20 mm, 25 mm, 1/2", 3/4" or 1" pipe or equivalent size tubing.
- Features ChemSaver drip-free shutoff. Requires 10 PSI (0.7 bar) at the nozzle to open check valve.
- Standard diaphragm of EPDM with optional Viton available.
- Mounts to a 3/8" (9.5 mm) or 5/32" (7.0 mm) hole drilled in pipe or tubing.
- All sizes include a mounting hole in upper clamp subassembly for mounting to flat surfaces.
- Maximum operating pressure of 300 PSI (20 bar).
- Flow rate: 2.25 GPM (8.5 l/min) at 5 PSI (0.34 bar) pressure drop, 3.18 GPM (12.0 l/min) at 10 PSI (0.69 bar) pressure drop.

PART NUMBER	TO CLAMP ON	DRILL HOLE SIZE	UPPER CLAMP BOLT SIZE
QJ17560A-20mm-NYB	20 mm Tubing	.375" (9.5 mm)	5/16" or M8
QJ17560A-20mmx7-NYB	20 mm Tubing	.280" (7.0 mm)	5/16" or M8
QJ17560A-25mm-NYB	25 mm Tubing	.375" (9.5 mm)	5/16" or M8
QJ17560A-1/2-NYB	1/2" Pipe	.375" (9.5 mm)	5/16" or M8
QJ17560A-1/2x7-NYB	1/2" Pipe	.280" (7.0 mm)	5/16" or M8
QJ17560A-3/4-NYB	3/4" Pipe	.375" (9.5 mm)	5/16" or M8
QJ17560A-1-NYB	1" Pipe	.375" (9.5 mm)	5/16" or M8



QJ7421

QJ7421-NYB

- Can be mounted to 1/2", 3/4" or 1" pipe or equivalent size tubing.
- 1/2" and 3/4" sizes include a mounting hole in upper clamp subassembly for mounting to flat surfaces.
- Mounts to a 3/8" (9.5 mm) hole drilled in pipe or tubing.
- Maximum operating pressure of 300 PSI (20 bar).

PART NUMBER	TO CLAMP ON	DRILL HOLE SIZE	UPPER CLAMP BOLT SIZE
QJ7421-1/2-NYB	1/2" Pipe	.375" (9.5 mm)	1/4"
QJ7421-3/4-NYB	3/4" Pipe	.375" (9.5 mm)	1/4"
QJ7421-1-NYB	1" Pipe	.375" (9.5 mm)	N/A



- Fittings feature push to connect couplers for fast, easy, leak-free assembly.
- Offered in body, straight cap, 90° fixed cap and 90° swivel cap.
- Accepts plastic and soft metal tubing.
- Commonly used for liquid fertilizer application systems on planters and toolbars.
- Maximum operating pressure of 100 PSI (7 bar).
- Caps include CP18999-EPR gasket.

How to order:

Specify model number.
Example: QJ98595-1/4-*

90° Caps



Body



Straight Cap



Swivel Cap



PART NUMBER	TUBING SIZE (OD)	DESCRIPTION
QJ98595-1/4-*	1/4"	Straight Cap & Body
QJ114401-5/16-*	5/16"	Straight Cap & Body
QJ98594-3/8-*	3/8"	Straight Cap & Body
QJ98592-1/4-*	1/4"	Body
QJ114400-5/16-*	5/16"	Body
QJ98590-3/8-*	3/8"	Body
QJ98588-1/4	1/4"	Straight Cap
QJ114398-5/16	5/16"	Straight Cap
QJ98586-3/8	3/8"	Straight Cap
QJ98598-90-1/4	1/4"	90° Fixed Cap
QJ98599-90-3/8	3/8"	90° Fixed Cap
QJ114403-1/4	1/4"	90° Swivel Cap
QJ114404-5/16	5/16"	90° Swivel Cap
QJ114405-3/8	3/8"	90° Swivel Cap
QJ114430-1/4-*	1/4"	Capless Body, PTC In & PTC Out
QJ114432-5/16-*	5/16"	Capless Body, PTC In & PTC Out
QJ114434-3/8-*	3/8"	Capless Body, PTC In & PTC Out

*Specify diaphragm check valve opening pressure.

Body & Cap Assembly





Quick TeeJet® Caps

Color Code

1	2	3	4	5	6	7	8	9	10
Black	White	Red	Blue	Green	Yellow	Brown	Orange	Gray††	Violet

Ordering Information

QUICK TEEJET CAPS	PART NUMBER		FOR USE WITH FLAT SPRAY TIPS 300 PSI (20 bar) MAXIMUM PRESSURE
	QUICK TEEJET CAP ONLY	QUICK TEEJET CAP & SEAT GASKET SET	
	CP25611- *-NY	25612- *-NYR	TeeJet® Flat Spray Tips (Smaller Capacities) TP Standard -0067 Thru -08 XR -01 Thru -08 DG TeeJet® TT TTJ60 Turbo TwinJet AIXR TeeJet® OC TeeJet
	CP25611-9-PP††	25612-9-PP††	
	CP25609- *-NY	25610- *-NYR	TeeJet Flat Spray Tips (Larger Capacities) TP Standard -10 Thru -20 XR -10 Thru -15
	CP25597- *-NY	25598- *-NYR	TJ60 TwinJet® AI TeeJet and AIUB TeeJet SJ3 StreamJet DG TwinJet® Turbo TeeJet Induction® AITTJ60 Turbo TwinJet (02-06)
	CP98578-1-NY†	98579-1-NYR†	AI3070 AITTJ60 Turbo TwinJet (08-15)
	CP25595- *-NY	25596- *-NYR	TeeJet Flat Spray Tips (Smaller Capacities) Tips can be positioned in choice of two spray plane directions—parallel or perpendicular to wings of Quick TeeJet cap.
	CP25599- *-NY	25600- *-NYR	Turbo FloodJet® VisiFlo® Spray Tip TK-VS FloodJet® VisiFlo Spray Tip TK-VP FloodJet® VisiFlo Spray Tip Locating Nib
	CP25607- *-NY	25608- *-NYR	TK FloodJet® FL FullJet® TX/TXA ConeJet® TG Full Cone Hose Shank AITXA ConeJet
	CP25607-9-PP††	25608-9-PP††	
	CP25607- *-NY	—	D-Disc Core Seal CP18999-EPR (EPDM standard) CP18999-VI (Viton® optional) Used with DC-Core Inserts and CP4916 Flow Regulators (Insert Core into Seal)
	CP26277-1-NY†	26278-1-NYR†	Ceramic Disc-Core D-Disc Core TXB ConeJet® AITXB ConeJet
	CP114395-1-NYB†	114396-1-NYR†	TXR ConeJet 114396-1-NYR includes gasket and O-ring (CP7717-M10.5x1.5-VI)

*Specify color code (see chart). Violet (10) only available in CP25611 and CP25597 Nylon caps.

†These Quick TeeJet caps available only in black.

††Polypropylene Quick TeeJet caps available only in gray and rated to 150 PSI (10 bar). Nylon caps not available in gray.

Quick TeeJet Cap

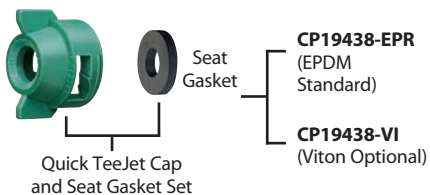

The Quick TeeJet caps are designed with grooves that fit locating lugs on the nozzle body. Caps are made of Nylon and are available for use with all TeeJet® spray tips. Maximum operating pressure of 300 PSI (20 bar).

How to order:

For cap and seat gasket set, specify set number and color code.

Example: 25612-3-NYR

For cap only, specify part number and color code.

Example: CP25597-4-NY

For seat gasket, specify part number.

Example: CP19438-EPR



Ordering Information

QUICK TEEJET CAPS	PART NUMBER		FOR USE WITH FLAT SPRAY TIPS 300 PSI (20 bar) MAXIMUM PRESSURE
	QUICK TEEJET CAP ONLY	QUICK TEEJET CAP & SEAT GASKET SET	
	QJ4676-45-1/4-NYR†		45° Quick TeeJet cap with 1/4" NPT female threaded outlet
	QJ4676-90-1/4-NYR†		90° Quick TeeJet cap with 1/4" NPT female threaded outlet
	QJ4676-1/8-NYR†		Permits use of standard 1/8" and 1/4" nozzles. Can be used for mounting pressure gauge at the nozzle. See Data Sheet 20055 for more information. (B) = BSPT
	QJ(B)4676-1/4-NYR†		
	19843-NYR†		Provides shutoff at nozzle for quick spacing change or change in spray swath.

†These Quick TeeJet caps available only in black.

Color Code

1	2	3	4	5	6	7	8	9
Black	White	Red	Blue	Green	Yellow	Brown	Orange	Gray††

Caps for Hardi® Nozzle Bodies

QUICK TEEJET CAPS	PART NUMBER		FOR USE WITH FLAT SPRAY TIPS 150 PSI (10 bar) MAXIMUM PRESSURE						
	QUICK TEEJET CAP ONLY	QUICK TEEJET CAP & SEAT GASKET SET							
	CP21399-*-CE	21398H-*-CELR	TJ60 TwinJet® 	AI TeeJet & AIUB TeeJet 	SJ3 StreamJet 	DG TwinJet® 	Turbo TeeJet® Induction 	AITTJ60 Turbo TwinJet (02-06)	
	CP23307-*-CE	23306H-*-CELR	TP Standard (-0067 Thru -08)	XR TeeJet® (-01 Thru -08)	AIXR TeeJet 	DG TeeJet® 	Turbo TeeJet 	OC TeeJet (-01 Thru -08)	TTJ60 Turbo TwinJet
	CP58350-*-CE	58348H-*-CELR	TK FloodJet® 	FL FullJet® 	TX ConeJet® 	TG Full Cone 	Hose Shank 	AITXA ConeJet 	

Note: When using TeeJet tip strainer, use CP26227 gasket in place of CP23308 gasket. See page 66 for 55240 Hardi to TeeJet adapter.

*Specify color code (see chart).

Quick TeeJet® Rapid Stop Nozzle Body Adapter

- Extended inlet tube for wet boom nozzle bodies raises inlet tube height to evacuate trapped air from spray boom.
- Can significantly reduce the shut off and turn on time of spray tips for more precise application.
- Easily installed into a wide range of TeeJet wet boom nozzle bodies.
- Stainless steel construction for strength and excellent chemical resistance.

PART NUMBER	WET BOOM SIZE	FITS TEEJET NOZZLE BODY
CP98583-1-3/4-SS	3/4" Pipe	QJ360C, QJ380, QJ380F, QJS
CP98583-1-1-SS	1" Pipe	
CP98583-2-3/4-SS	3/4" Pipe	QJ17560A, 24216A
CP98583-2-1-SS	1" Pipe	
CP98583-3-1-SS	1" Pipe QJ360F	QJ360F



QJ17560A



QJT8360-NYB, QJP19011-NYB, QJ8360-NYB

- Retrofits to a Quick TeeJet system.
- Features ChemSaver® no-drip shutoff. Requires 10 PSI (0.7 bar) at the nozzle to open check valve.
- Standard diaphragm of EPDM with optional Viton® available upon request.
- Maximum operating pressure of 300 PSI (20 bar).
- Flow rate: 2.25 GPM (8.5 l/min) at 5 PSI (0.34 bar) pressure drop, 3.18 GPM (12.0 l/min) at 10 PSI (0.69 bar) pressure drop.



QJ8360-NYB



QJT8360-NYB
QJP19011-NYB

PART NUMBER	TO FIT
QJ(B)8360-NYB	¼" (F) thread
QJT8360-NYB	1½"-16 (M) TeeJet thread
QJP19011-NYB	¾" (M) BSPP thread

(B)=BSPT

QJ1/4T-NYB & QJT-NYB

- QJ1/4T-NYB allows use of Quick TeeJet system with ¼" NPT and BSPT male connections.
- QJT-NYB permits use of Quick TeeJet system with standard 1½"-16 TeeJet thread.
- Maximum operating pressure of 300 PSI (20 bar).



PART NUMBER	TO FIT
(B)QJ1/4T-NYB	¼" (M) thread
QJT-NYB	1½"-16 (M) TeeJet thread

(B)=BSPT

22674-1/4-NYB

- Allows use of Quick TeeJet system with ¼" NPT or BSPT female connections.



PART NUMBER	TO FIT
(B) 22674-1/4-NYB	¼" (F) thread

(B)=BSPT

QJ8355-NYB

- Allows use of Quick TeeJet system with ½" and ¼" NPT female connections.
- Side mounting provides protection of the nozzle body.
- Features ChemSaver no-drip shutoff. Requires 10 PSI (0.7 bar) at the nozzle to open check valve.
- Standard diaphragm of EPDM with optional Viton available upon request.
- Maximum operating pressure of 300 PSI (20 bar).
- Flow rate: 2.25 GPM (8.5 l/min) at 5 PSI (0.34 bar) pressure drop, 3.18 GPM (12.0 l/min) at 10 PSI (0.69 bar) pressure drop.



PART NUMBER	TO FIT
QJ8355-1/8-NYB	½" (M)
QJ8355-1/4-NYB	¼" (M)

QJ1/4TT-NYB

- Allows use of Quick TeeJet system with ¼" NPT and BSPT female connections.
- Maximum operating pressure of 300 PSI (20 bar).



PART NUMBER	TO FIT
QJ(B)1/4TT-NYB	¼" (F) thread

(B)=BSPT

55240-CELR

- Converts Hardi® snap-fit nozzle body connection to Quick TeeJet connection for easy installation of TeeJet tips. Especially useful for AIC, XRC and SJ7 tips.
- Acetal construction with EPDM gasket for durability and chemical resistance.
- Accepts standard tip strainers.
- Maximum operating pressure of 150 PSI (10 bar).



PART NUMBER	TO FIT
55240-CELR	Hardi Snap-Fit

QJ90-1-NYR

- Fits standard Quick TeeJet bodies.
- Nylon body construction for strength and durability, with EPDM gasket (Viton® optional).
- Outlet can be fitted with Quick TeeJet caps and TeeJet spray tips.
- One piece, 90° elbow is ideal for installation of TK-VS FloodJet® and TF-VS or TF-VP Turbo FloodJet nozzles on single or multiple outlet nozzle bodies. Proper orientation of spray tip enhances spray distribution quality.
- Adapter outlet accepts standard tip strainers.
- Maximum operating pressure of 300 PSI (20 bar).



PART NUMBER	TO FIT
QJ90-1-NYR	Quick TeeJet

QJ90-2-NYR

- Fits standard Quick TeeJet bodies.
- Made of Nylon with CP19438-EPR gasket (included).
- Use with Quick TeeJet cap and gasket for automatic alignment when using flat fan spray tips.
- 90° included angle between outlets. When used with standard flat fan tips produces a twin type spray pattern for improved coverage and canopy penetration.
- Maximum operating pressure of 300 PSI (20 bar).



PART NUMBER	TO FIT
QJ90-2-NYR	Quick TeeJet

50854-NYB

- For use with Quick TeeJet nozzle bodies to extend body length by 1 inch (25 mm).
- Used to eliminate interference of spray pattern with sprayer boom structure or shields, particularly with twin pattern or fertilizer spray tips.
- Nylon body construction with EPDM gasket.
- Maximum operating pressure of 300 PSI (20 bar).



PART NUMBER	TO FIT
50854-NYB	Quick TeeJet



In this type of nozzle body, the diaphragm check valve is an integral part of the nozzle assembly. This design eliminates the pressure drop associated with ball-type check valves. The spring-backed diaphragm ensures dependable closure. Originally developed for use in aerial spraying, nozzle bodies of this design are now widely used wherever drip-free shutoff is required. For maximum operating pressures of 125 PSI (9 bar).

Typical Assembly

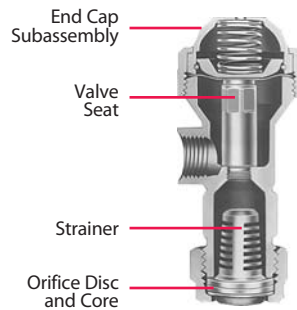

8355

Made of Nylon with Nylon/polypropylene end cap assembly. Check valve opens at 10 PSI (0.7 bar) pressure. Choice of 1/8" or 1/4" NPT (F) inlet connections. Flow rate for 1/8" is 3 GPM at 5 PSI pressure drop (11.4 l/min at 0.34 bar). Flow rate for 1/4" is 3.9 GPM at 5 PSI pressure drop (15 l/min at 0.34 bar). Overall length 2 3/4" (70 mm). Weight: 1 1/2 ounces (43 g).



12328-NYB

Made of Nylon with Celcon® bonnet. Check valve opens at 7 PSI (0.5 bar) pressure. (M) inlet connection and (F) outlet connections. Choice of 1/2" and 3/4" NPT sizes. Flow rate for 1/2" is 12 GPM at 5 PSI pressure drop (45 l/min at 0.34 bar). Flow rate for 3/4" is 16 GPM at 5 PSI pressure drop (61 l/min at 0.34 bar). Overall length 3" (76 mm). Weight: 9 ounces (0.26 kg).



8360

Made of Nylon with Nylon/polypropylene end cap assembly. Check valve opens at 10 PSI (0.7 bar) pressure. 1/4" NPT (M) inlet connection. Flow rate of 2.25 GPM at 5 PSI pressure drop (8.5 l/min at 0.34 bar). Overall length 2" (51 mm). Weight: 1 ounce (28 g).

ChemSaver® Diaphragm Check Valve Nozzle Bodies

Similar in design and performance to the TeeJet® Diaphragm Check Valve nozzle bodies, but with pipe thread outlet connections for spray nozzles instead of TeeJet caps and spray tips. For maximum operating pressures of 125 PSI (9 bar).



6140A

Made of brass. Check valve opens at 7 PSI (0.5 bar) pressure. Choice of 1/4" and 3/8" NPT (F) inlet connections. Outlet connection has dual 1/2" NPT external (M) thread and 3/8" NPT internal (F) thread. Flow rate of 4.5 GPM at 5 PSI pressure drop (17 l/min at 0.34 bar). Overall length 2 3/8" (61 mm). Weight: 2 1/2 ounces (71 g).



4664B

Made in choice of brass or aluminum with replaceable stainless steel valve seat. Check valve opens at 7 PSI (0.5 bar) pressure. 1/8" NPT (F) inlet connection. Flow rate of 2.0 GPM at 5 PSI pressure drop (7.5 l/min at 0.34 bar). Overall length 2 5/16" (59 mm). Weights: brass 3 ounces (85 g), aluminum 1 ounce (28 g).



4666B

Made in brass with replaceable stainless steel valve seat. 1/8" NPT (F) inlet and outlet connections. Flow rate of 2.0 GPM at 5 PSI pressure drop (7.5 l/min at 0.34 bar). Overall length 1 15/16" (49 mm). Check valve opens at 7 PSI (0.5 bar) pressure. Weight: 2 1/2 ounces (71 g).



6135A

Made of brass. Check valve opens at 7 PSI (0.5 bar) pressure. Choice of 1/4" and 3/8" NPT (F) inlet connections. Flow rate of 4.5 GPM at 5 PSI pressure drop (17 l/min at 0.34 bar). Overall length 2 5/8" (67 mm). Weight: 4 1/2 ounces (128 g).















(B)10742A

Made in choice of brass or aluminum. Check valve opens at 7 PSI (0.5 bar) pressure. 1/4" NPT (M) inlet and (F) outlet connections. Overall length 1 7/16" (37 mm). Flow rate of 2.25 GPM at 5 PSI pressure drop (8.5 l/min at 0.34 bar). Weights: brass 2 1/2 ounces (71 g), aluminum 2 ounces (57 g).

(B)=BSPT



TeeJet® Nozzle Body ChemSaver® Check Valves

CHEMSAVER DIAPHRAGM CHECK VALVES	EXPLODED VIEW																	
 <p>Back end of Diaphragm Check Valves (Brass)</p>	 <p>CP6227-TEF Diaphragm Teflon® (optional) To be used with 4620 Diaphragm</p>	 <p>CP4620-FA Diaphragm Fairprene® or Viton</p>	 <p>9758 End Cap Subassembly Brass, Aluminum</p>	 <p>CP4624 Retainer Brass, Aluminum</p>														
 <p>Back end of Diaphragm Check Valves (Nylon)</p>	 <p>CP6227-TEF Diaphragm Teflon (optional) To be used with 21953 Diaphragm</p>	 <p>CP21953-EPR Diaphragm EPDM or Viton Note: Nib on diaphragm fits into hole in end cap assembly.</p>	 <p>21950-NYB ChemSaver End Cap Assembly Nylon/polypropylene</p>	<table border="1"> <thead> <tr> <th>PART NUMBER</th> <th>APPROXIMATE OPENING PRESSURE</th> </tr> </thead> <tbody> <tr> <td>21950-2-NY</td> <td>2 PSI (0.14 bar)</td> </tr> <tr> <td>21950-5-NYB</td> <td>5 PSI (0.34 bar)</td> </tr> <tr> <td>21950-8-NYB</td> <td>8 PSI (0.6 bar)</td> </tr> <tr> <td>21950-10-NYB</td> <td>10 PSI (0.7 bar)</td> </tr> <tr> <td>21950-15-NY</td> <td>15 PSI (1 bar)</td> </tr> <tr> <td>21950-20-NYB</td> <td>20 PSI (1.4 bar)</td> </tr> </tbody> </table>	PART NUMBER	APPROXIMATE OPENING PRESSURE	21950-2-NY	2 PSI (0.14 bar)	21950-5-NYB	5 PSI (0.34 bar)	21950-8-NYB	8 PSI (0.6 bar)	21950-10-NYB	10 PSI (0.7 bar)	21950-15-NY	15 PSI (1 bar)	21950-20-NYB	20 PSI (1.4 bar)
PART NUMBER	APPROXIMATE OPENING PRESSURE																	
21950-2-NY	2 PSI (0.14 bar)																	
21950-5-NYB	5 PSI (0.34 bar)																	
21950-8-NYB	8 PSI (0.6 bar)																	
21950-10-NYB	10 PSI (0.7 bar)																	
21950-15-NY	15 PSI (1 bar)																	
21950-20-NYB	20 PSI (1.4 bar)																	
 <p>QJS</p>	 <p>CP56709-EPDM Diaphragm EPDM or Viton</p>	 <p>56714-NYB End Cap Subassembly</p>	 <p>CP56711-NYB Retaining Ring</p>															

TeeJet® Row Application Kit

The 23770 Adjustable Row Application Kit is for Applying Post-emergence Chemicals Over Crop Rows

Features:

- Arms adjustable for length and angle without removing bolts; simply loosen.
- Available with stainless steel arms.
- Positioning one arm at proper angle automatically sets correct angle of second arm.
- Fits square or round booms up to 1½" diameter.
- Kit includes standard and Quick TeeJet® nozzle bodies.
- Side nozzle bodies may be rotated.
- Maximum pressure of 125 PSI (9 bar).
- Spray tips and strainers not included.

How to order:
Specify model number.
Example: 23770-SS



Model #23770 Row Application Kit
(Supplied without spray tips and strainers)



55295 e-ChemSaver® Electric Solenoid Shutoff

The 55295 e-ChemSaver is a solenoid actuated shutoff compatible with a wide range of TeeJet nozzle bodies equipped with a diaphragm check valve. It can be used for end of boom nozzles as well as individual tip shutoff and PWM controls.

- Valve is normally closed and opens when solenoid is energized.
- Wetted materials include stainless steel and Viton®.
- Use with most diaphragm check valve equipped TeeJet nozzle bodies.
- 100 PSI (6.8 bar) maximum spraying pressure at minimum voltage (12V or 24V).
- 0.6 GPM (2.27 l/min) at 5 PSI (0.34 bar) pressure drop and 0.8 GPM (3.0 l/min) at 10 PSI (0.7 bar) pressure drop.
- ¼ second response time.
- Offered in 12- or 24-Volt DC version.
- 2-Pin MetriPack connector molded into body for a clean, weather-tight electrical connection.



55295

PART NUMBER	VOLTAGE (DC)	FOR USE WITH TEEJET NOZZLE BODY
55295-1-12	12	QJ17560A, QJ360E, QJ200, QJ300, 24216A, 24230A, QJ39685, QJ(T)8360
55295-1-24	24	
55295-2-12	12	QJ360C, QJ22187, QJ8355
55295-2-24	24	
55295-4-12	12	QJS
55295-4-24	24	

55300 Air ChemSaver Shutoff

55300 ChemSaver Air Shutoff Valve is designed as a pneumatic valve for use on Quick TeeJet® nozzle assemblies. Air pressure is used to open the valve and a spring is used to close the valve.

- Wetted materials include polypropylene, Kynar® and Viton.
- 45 PSI (3.1 bar) minimum air pressure.
- 150 PSI (1b bar) maximum liquid pressure.
- Air inlet fitting swivels around body and accepts 6mm push-to-connect fittings for fast installation.
- Valve is normally closed.
- Very low air consumption per cycle reduces load on air supply system.



55300

58140 ChemSaver Manual Shutoff

- Use with any application where individual shutoff is important such as golf course and estate sprayers.
- Fits any Quick TeeJet nozzle body with diaphragm check valve.
- With retaining ring in fully open position (turn counterclockwise), functions like a standard 10 PSI (0.7 bar) diaphragm check valve.
- With retaining ring in fully closed position (turn clockwise), all flow through nozzle body is shut off.
- 150 PSI (10 bar) maximum pressure rating.
- Nylon construction.



58140

How to order:

Specify model number.

Example: 55295-1-12 – e-ChemSaver Shutoff

55300 – Air ChemSaver Shutoff

58140-NYB – Manual ChemSaver Shutoff

98450 Series Brass Rollover

TeeJet rollovers are designed for use on air blast sprayers in orchard and vineyard spraying applications. These compact rollovers are available with or without diaphragm check valve, offer a choice of single- or double-outlet configurations, and are available with a variety of inlet connection sizes and thread types.

Precision machined forged brass construction makes TeeJet rollovers both rugged and durable.

- Maximum recommended pressure of 750 PSI (52 bar)
- Flow rate of 1.6 GPM (6.1 l/min) with a 10 PSI (0.69 bar) pressure drop
- Two shutoff positions at 90° from open
- Three open positions at vertical and +/-15° from vertical with positive detent
- 1/16"-16 outlet thread accepts standard tip retaining caps

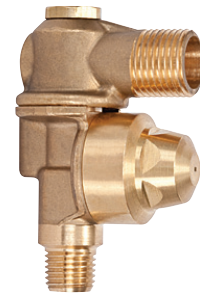

98451
Single Outlet

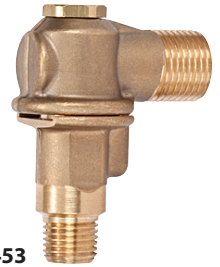

98453
Single Outlet

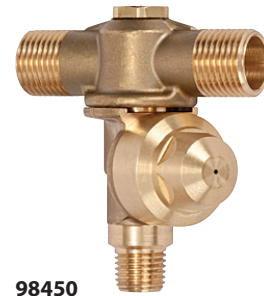

98450
Double Outlet

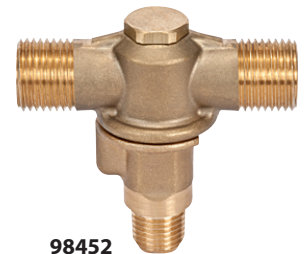

98452
Double Outlet

Sample Rollover Part Number:

B98450-1/4F

INLET THREAD TYPE	
BLANK	NPT
B	BSPT
S	NPS
P	BSPP

Note: NPS & BSPP versions include locking nut on inlet

MODEL SPECIFICATION	
9845	ROLLOVER

INLET THREAD SIZE	
1/4F	1/4" FEMALE
1/4M	1/4" MALE
3/8M	3/8" MALE

Note: 1/4F not available in NPS or BSPP

BODY CONFIGURATION	
0	DOUBLE OUTLET, WITH CHECK VALVE
1	SINGLE OUTLET, WITH CHECK VALVE
2	DOUBLE OUTLET, NO CHECK VALVE
3	SINGLE OUTLET, NO CHECK VALVE

Plug Valve

A compact quarter turn on-off valve for many applications. Low-profile handle is suited for use on airblast sprayers. Maximum operating pressure of 400 PSI (28 bar). Brass with Celcon® handle.

PLUG VALVE NUMBER	CONNECTIONS IN NPT
(B)23220-1/4F x 1/4F	1/4" (F) x 1/4" (F)
(B)23220-1/8F x 1/8F	1/8" (F) x 1/8" (F)
(B)23220-1/4M x T	1/4" (M) x 1/16"-16 (M)
(B)23220-1/4F x T	1/4" (F) x 1/16"-16 (M)
(B)23220-1/4M x 1/4F	1/4" (M) x 1/4" (F)
(B)23220-1/4F x 1/4M	1/4" (F) x 1/4" (M)

(B)=BSPT

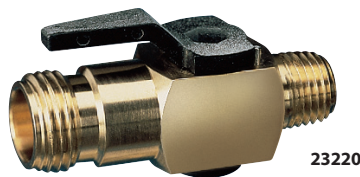

23220

Typical Assembly with Ceramic Disc and Core



4514-NY
Slotted
Strainer*

Core

Disc

CP20230
TeeJet Cap

*Use CP20229-NY gasket when 4514-NY Nylon slotted strainer is not used.



Quick TeeJet® Swivel Nozzle Bodies

QJ8600 swivel Quick TeeJet nozzle body assemblies provide the same spray tip adjustability of a standard TeeJet threaded swivel plus the quick change and self-aligning features of the Quick TeeJet System.



QJ8600-2-1/4-NYB
Double Swivel Nozzle

PART NUMBER	PIPE THREAD	MATERIAL
QJ8600-2-1/4-NYB	1/4" NPT (F)	Nylon



QJ8600-1/4-NYB
Single Swivel Nozzle

PART NUMBER	PIPE THREAD	MATERIAL
QJ8600-1/4-NYB	1/4" NPT (F)	Nylon

Swivel Nozzle Bodies

TeeJet swivel nozzle bodies are primarily for use with tips employed in row crop spraying. A locknut holds swivel bodies firmly in position at selected spray projection angle so they are not affected by jarring and vibration. For use at pressures up to 125 PSI (9 bar).



Type 5000
Single Swivel Nozzle

PART NUMBER	INLET CONNECTION	MATERIAL	SWIVEL ARC RANGE
(B)5000-1/4T	1/4" NPT (F)	Brass	280°



Type 5540
Single Swivel Nozzle

PART NUMBER	INLET CONNECTION	MATERIAL	SWIVEL ARC RANGE
(B)5540-1/4TT	1/4" NPT (M)	Brass	280°



Type 4202
Double Swivel Nozzle

PART NUMBER	INLET CONNECTION	MATERIAL	SWIVEL ARC RANGE
4202-2-1/4T	1/4" NPT (F)	Brass	280°



Type 6240
Double Swivel Nozzle

PART NUMBER	INLET CONNECTION	MATERIAL	SWIVEL ARC RANGE
(B)6240-1/4TT	1/4" NPT (M)	Brass	280°



Type 7450 Compact
Double Swivel Nozzle

PART NUMBER	INLET CONNECTION	MATERIAL	SWIVEL ARC RANGE
(B)7450-2T	1/4" NPT (F)	Brass	280°



Type 5932
Double Swivel Nozzle 1/4" NPT female bottom outlet

PART NUMBER	INLET CONNECTION	MATERIAL	SWIVEL ARC RANGE
5932-2-1/4T	1/4" NPT (F)	Brass	280°



Type 8600 Nylon
Single Swivel Nozzle

PART NUMBER	INLET CONNECTION	MATERIAL	SWIVEL ARC RANGE
8600-1/4T-NYB	1/4" NPT (F)	Nylon	280°



Type 8600-2 Nylon
Double Swivel Nozzle

PART NUMBER	INLET CONNECTION	MATERIAL	SWIVEL ARC RANGE
8600-2-1/4T-NYB	1/4" NPT (F)	Nylon	280°



Type 7620 Compact
Single Swivel Nozzle

PART NUMBER	INLET CONNECTION	MATERIAL	SWIVEL ARC RANGE
(B)7620-T	1/4" NPT (F)	Brass	360°

How to order:

Examples: 5000-1/4T Brass NPT
B5000-1/4T Brass BSPT

Note: Swivels do not include tips, strainers or caps.

TeeJet® Hose Drops

Hose drops connect to standard and Quick TeeJet nozzle bodies and can also be used with swivels. Available in 15" (380 mm) and 24" (610 mm) lengths. Maximum operating pressure of 125 PSI (9 bar).

Note: QJ1/4T-NYB can be attached to hose drops for use with Quick TeeJet caps. See page 66 for ordering information.

ITEM	HOSE DROP NUMBER	LENGTH	INLET CONNECTION	OUTLET CONNECTION	MATERIAL
A	21353-6-15-NYB	15" (380 mm)	Quick TeeJet Type	1/4" NPT (M)	Nylon with Quick TeeJet cap and EPDM gasket
	21353-6-24-NYB	24" (610 mm)			
B	21354-15-NYB	15" (380 mm)	1 1/16"-16 TeeJet Thread		Nylon
	21354-24-NYB	24" (610 mm)			

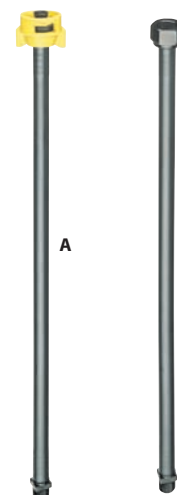

QJ1/4T-NYB



TeeJet® Hose Shank Nozzle Bodies

For Operating Pressures up to 125 PSI (9 bar)

Brass, stainless steel, Nylon and Celcon®/stainless steel hose shank nozzle bodies. Features 1/16"-16 TeeJet threaded outlet.

See page 73 for clamp assemblies.

Single Hose Connection

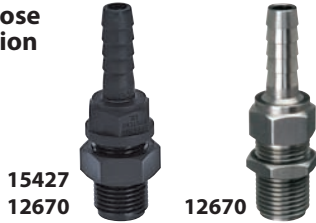

15427
12670

12670

HOSE SHANK BODY ASSEMBLY NUMBER	TO FIT HOSE I.D.	MATERIAL
15427-296	1/4"	Brass
12670-406TD	3/8"	Nylon
12670-406TD-SS	3/8"	Stainless Steel

Single Hose Connection



6471B
8121-NYB
9191B
12201-CE

HOSE SHANK BODY ASSEMBLY NUMBER	TO FIT HOSE I.D.	MATERIAL
6471B-400TD	3/8"	Brass
6471-SS-C400TD	3/8"	Stainless Steel
8121-NYB-406TD	3/8"	Nylon
8121-NYB-540TD	1/2"	Nylon
9191B-531TD	1/2"	Brass
9191-SS-C531TD	1/2"	Stainless Steel
12201-CE-785TD	3/4"	Celcon Hose Shank/ Stainless Steel Threaded Outlet
12201-CE-1062TD	1"	Celcon Hose Shank/ Stainless Steel Threaded Outlet

Double Hose Connection



6472B
8120-NYB
9192B
12202-CE

HOSE SHANK BODY ASSEMBLY NUMBER	TO FIT HOSE I.D.	MATERIAL
6472B-400TD	3/8"	Brass
6472-SS-C400TD	3/8"	Stainless Steel
8120-NYB-406TD	3/8"	Nylon
8120-NYB-540TD	1/2"	Nylon
9192B-531TD	1/2"	Brass
9192-SS-C531TD	1/2"	Stainless Steel
12202-CE-785TD	3/4"	Celcon Hose Shank/ Stainless Steel Threaded Outlet
12202-CE-1062TD	1"	Celcon Hose Shank/ Stainless Steel Threaded Outlet

How to order:

To order body assembly only, specify hose shank assembly number.

Example: 12202-CE-1062

Triple Hose Connection



8124-NYB

HOSE SHANK BODY ASSEMBLY NUMBER	TO FIT HOSE I.D.	MATERIAL
8124-NYB-406TD	3/8"	Nylon
8124-NYB-540TD	1/2"	Nylon

TeeJet® Split Eyelet Nozzle Bodies

For Wet Booms

- Mounting on 1/2", 3/4" or 1" pipe or tubing.
- 25775-NYB mounts to 3/8" (9.5 mm) hole drilled in pipe or tubing.
- 7421 mounts to 7/32" (7.2 mm) hole drilled in pipe or tubing.
- 25775-NYB and 7421 feature 1/16"-16 TeeJet threaded outlets.
- 25888-NYB features 1/4" (M) NPT threaded outlet.

How to order:

Specify split eyelet assembly number.

Examples: 7421-1/2T-SS
25775-1/2T-NYB
25888-1/2-NYB



25775-NYB
Operating pressures up to 150 PSI (10 bar)



7421
Operating pressures up to 250 PSI (17 bar)

SPLIT EYELET ASSEMBLY NUMBER	MATERIAL	TO CLAMP ON
25775-1/2T-NYB 25888-1/2-NYB	Nylon	1/2" Pipe 13/16" O.D. Tubing 7/8" O.D. Tubing
25775-3/4T-NYB 25888-3/4-NYB	Nylon	3/4" Pipe 1" O.D. Tubing 1 1/16" O.D. Tubing
25775-1T-NYB 25888-1-NYB	Nylon	1" Pipe 1 1/4" O.D. Tubing 1 3/8" O.D. Tubing

SPLIT EYELET ASSEMBLY NUMBER	BODY MATERIAL	TO CLAMP ON
7421-1/2T	Brass	1/2" Pipe
7421-1/2T-SS	Stainless Steel	13/16" O.D. Tubing 7/8" O.D. Tubing
7421-1/2T-NYB	Nylon	7/8" O.D. Tubing
7421-3/4T	Brass	3/4" Pipe
7421-3/4T-SS	Stainless Steel	1" O.D. Tubing 1 1/16" O.D. Tubing
7421-3/4T-NYB	Nylon	1 1/16" O.D. Tubing
7421-1T	Brass	1" Pipe
7421-1T-SS	Stainless Steel	1 1/4" O.D. Tubing 1 3/8" O.D. Tubing
7421-1T-NYB	Nylon	1 3/8" O.D. Tubing



Standard Parts

TeeJet Spray Nozzle



=

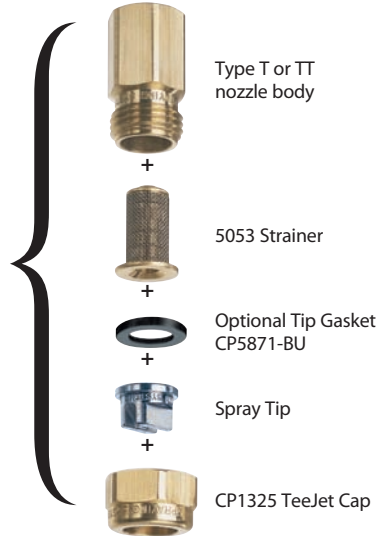

11750 TeeJet Check Valve

For larger capacity TeeJet nozzles where strainers are not required. Ball check opens at 5 PSI (0.34 bar), 10 PSI (0.7 bar) spring also available. Recommended for flow rates from .40 to 1.5 GPM (1.5–5.7 l/min). Made in choice of stainless steel, brass, aluminum or polypropylene with stainless steel ball and spring.



TeeJet Nozzle Bodies



Type-TT
Male Inlet NPT or BSPT Connection

TEEJET BODY NUMBER	FOR TEEJET NOZZLE TYPE	MALE SIZE	MATERIAL
CP(B)1336	1/8TT	1/8"	Brass
CP(B)1322	1/4TT	1/4"	Brass
CP(B)8028-NYB	1/4TT-NYB	1/4"	Nylon
CP(B)1322-I	1/4TT-I	1/4"	Steel
CP(B)1322-SS	1/4TT-SS	1/4"	Stainless Steel
CP(B)1324	3/8TT	3/8"	Brass
CP(B)1340	1/2TT	1/2"	Brass
CP(B)3818	3/4TT	3/4"	Brass
CP(B)3818-SS	3/4TT	3/4"	Stainless Steel

(B) = BSPT



Type-T
Female Inlet NPT or BSPT Connection

TEEJET BODY NUMBER	FOR TEEJET NOZZLE TYPE	FEMALE SIZE	MATERIAL
CP(B)1335	1/8T	1/8"	Brass
CP(B)1321	1/4T	1/4"	Brass
CP(B)12094-NYB	1/4T-NYB	1/4"	Nylon
CP(B)1321-I	1/4T-I	1/4"	Steel
CP(B)1321-SS	1/4T-SS	1/4"	Stainless Steel
CP(B)1323	3/8T	3/8"	Brass
CP(B)1339	1/2T	1/2"	Brass
CP3817	3/4T	3/4"	Brass
CP3817-SS	3/4T	3/4"	Stainless Steel

(B) = BSPT

CP1325



CP18032A-NYB

TeeJet Nozzle Caps

Secure interchangeable TeeJet tips to the various nozzle bodies. 18032A-NYB winged TeeJet cap allows quick change of spray tips with no tool required.

TEEJET CAP NUMBER	DESCRIPTION
CP1325	Brass
CP8027-NYB	Nylon
CP8027-1-NYB	Nylon (Extra-long size)
CP1325-AL	Aluminum
CP1325-SS	Stainless Steel
CP18032A-NYB	Winged Cap, Nylon
CP3819	Brass, use with 3/4T & 3/4TT body
CP3819-SS	Stainless Steel, use with 3/4T & 3/4TT body
CP20230	Brass, use with ceramic disc-cores

45° Nozzle Body

Ideal for use with FullJet®, FloodJet® and Turbo FloodJet® nozzles. Can be used with QJ4676 Quick TeeJet® cap or standard 4676 outlet adapter. Made of polypropylene.



TEEJET BODY NUMBER	INLET	OUTLET
(B)22669-1/4-PPB	1/4" (M)	1/16"-16 (M)

How to order:

Specify part number.

Example: (B)22669-1/4-PPB

(B) = BSPT

Clamp Assemblies

Consist of upper and lower clamps and bolt for use with hose shank nozzle bodies.



PART NUMBER	TO CLAMP ON
AA111-1/2	1/2" Pipe (13/16" & 7/8" O.D. Tubings)
AA111-3/4	3/4" Pipe (1" & 11/16" O.D. Tubings)
AA111-1	1" Pipe (11/8", 11/4" & 13/8" O.D. Tubings)
AA111-1-1/4	11/4" Pipe (11/2" & 13/16" O.D. Tubings)

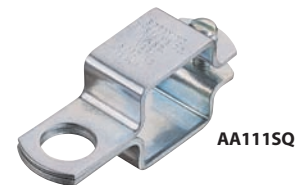

PART NUMBER	TO CLAMP ON
AA111SQ-1	1" Square Tubing
AA111SQ-1-1/4	11/4" Square Tubing
AA111SQ-1-1/2	11/2" Square Tubing



Pipe Plugs

NUMBER	THREAD	MATERIAL
(B)8400-1/4-PPB	1/4" NPT	Polypropylene
8400-3/8-NYB	3/8" NPT	Nylon
8400-1/2-NYB	1/2" NPT	Nylon
8400-3/4-NYB	3/4" NPT	Nylon

How to order:

Specify part number.
Example: 8400-3/8-NYB Nylon

(B) = BSPT

Plug Tip



CP3942 plug tip is used to temporarily shut off selected nozzles by replacing spray tips with these plug tips. Quick, easy way to change spacing of nozzles along boom. Materials: brass, aluminum or stainless steel.

How to order:

Specify part number and material.
Example: CP3942-SS

TeeJet Hose Shanks

For attaching hose to nozzle body. Fits all standard TeeJet nozzle caps, replacing spray tips. Type 4251 is available in choice of brass or stainless steel. Type 8400 is made of Nylon.



HOSE SHANK NUMBER	FOR HOSE I.D.	MATERIAL
8400-406-NYB	3/8"	Nylon
8400-500-NYB	1/2"	Nylon
4251-250	1/4"	Brass
4251-250-SS	1/4"	Stainless Steel
4251-312	5/16"	Brass
4251-312-SS	5/16"	Stainless Steel
4251-400	3/8"	Brass
4251-400-SS	3/8"	Stainless Steel
4251-437	7/16"	Brass
4251-437-SS	7/16"	Stainless Steel
4251-500	1/2"	Brass
4251-500-SS	1/2"	Stainless Steel

How to order:

Specify hose shank number and material.
Example: 4251-250 Brass

4676 TeeJet Outlet Adapters



Fits the outlets of TeeJet nozzle bodies as well as the outlets of various GunJet® spray guns and shutoff valves. Replaces CP1325 TeeJet cap. Used for attaching hose drops to nozzles or extensions to spray guns.

ADAPTER NUMBER	MATERIAL OUTLET CONNECTION	NPT (F)
(B)4676-*	Brass	1/8" 1/4" 3/8" 1/2" 3/4"
4676-NYB-*	Nylon	1/8" 1/4"
(B)4676-SS-*	Stainless Steel	1/8" 1/4" 3/8" 1/2" 3/4"

*Specify outlet connection.

(B) = BSPT

How to order:

Specify adapter number and material.
Example: (B)4676-SS-1/4 Stainless Steel



TeeJet Outlet Fittings

These fittings replace spray tips and are used for attaching drop pipes to nozzle bodies or adding extensions to AA23 and AA31 GunJet spray guns and trigger valves.

CP4928 Adapter—Brass, aluminum or stainless steel. Length 1". 1/8" NPT female outlet connection.

CP6250 Adapter—Brass or steel. Length 5/16". 1/8" NPT female outlet connection.

6406 Adapter—Brass, aluminum or steel. Length 15/16". 1/8" NPT male outlet connection.

How to order:

Specify part number and material.
Example: CP4928 Brass

Hose Shank Adapters



CONNECTOR NUMBER	NPT THREAD CONN. (MALE)	FOR HOSE I.D.	MATERIAL
8400-1/4-300-NYB	1/4"	1/4"	Nylon
8400-1/4-406-NYB	1/4"	3/8"	Nylon
8400-1/4-535-NYB	1/4"	1/2"	Nylon
8400-3/8-406-NYB	3/8"	3/8"	Nylon
8400-3/8-535-NYB	3/8"	1/2"	Nylon
8400-1/2-406-NYB	1/2"	3/8"	Nylon
8400-1/2-535-NYB	1/2"	1/2"	Nylon
8400-3/4-535-NYB	3/4"	1/2"	Nylon
8400-3/4-660-NYB	3/4"	5/8"	Nylon
8400-3/4-785-NYB	3/4"	3/4"	Nylon
8400-T-406-NYB TeeJet Body w/ hose shank connection	Fits TeeJet Cap	3/8"	Nylon



CONNECTOR NUMBER	NPT THREAD CONN.	FOR HOSE I.D.	MATERIAL
13434-406-NYB	1/4" (F)	3/8"	Nylon
13437-540-NYB	1/4" (F)	1/2"	Nylon

How to order:

Specify connector number and material.
Example: 6053-400 Brass



CONNECTOR NUMBER	NPT THREAD CONN. (MALE)	FOR HOSE I.D.	MATERIAL
6053-400	1/4"	3/8"	Brass
6100-675	3/4"	5/8"	Brass
6100-800	3/4"	3/4"	Brass
10123-1/4-281	1/4"	1/4"	Brass



CONNECTOR NUMBER	NPT THREAD CONN.	FOR HOSE I.D.	MATERIAL
13435-406-NYB	1/4" (F)	3/8"	Nylon
13438-540-NYB	1/4" (F)	1/2"	Nylon



CONNECTOR NUMBER	NPT THREAD CONN.	FOR HOSE I.D.	MATERIAL
13436-406-NYB	1/4" (F)	3/8"	Nylon
13439-540-NYB	1/4" (F)	1/2"	Nylon

TeeJet® 800 Series Flow Meters



800 Series Flow Meters

- Turbine style design for optimal accuracy.
- Durable ruby-bearings for long wear life.
- Easily removed “quick check” turbine for quick cleanup and service.
- Operating voltage of +4.5–16 VDC with LED status light.
- Wetted parts are glass-filled polypropylene, stainless steel and Viton®.

- 801 and 801A feature 300 PSI (20 bar) pressure rating.
- 802 features 200 PSI (14 bar) pressure rating.



PART NUMBER	DESCRIPTION	FLOW CAPACITY
801A	801A Flow Meter with 4-Bolt Flange and Deutsch (TeeJet) Connector For Use with 430 Manifold	2–60 GPM (7.5–225 l/min)
801	801 Flow Meter with 50-Series Flange and Deutsch (TeeJet) Connector	2–60 GPM (7.5–225 l/min)
57-10100	801 Flow Meter with 50-Series Flange and Conxall (Raven) Connector	2–60 GPM (7.5–225 l/min)
57-10127	801 Flow Meter with 50-Series Flange and Conxall (Raven) Connector	2–60 GPM (7.5–225 l/min)
90-50231	801 Flow Meter with 3/4" Straight Hose Barbs and Deutsch (TeeJet) Connector	2–60 GPM (7.5–225 l/min)
90-50273	801 Flow Meter with 3/4" Straight Hose Barbs and Conxall (Raven) Connector	2–60 GPM (7.5–225 l/min)
90-50230	801 Flow Meter with 1" Straight Hose Barbs and Deutsch (TeeJet) Connector	2–60 GPM (7.5–225 l/min)
90-50272	801 Flow Meter with 1" Straight Hose Barbs and Conxall (Raven) Connector	2–60 GPM (7.5–225 l/min)
90-50232	801 Flow Meter with 1 1/4" Straight Hose Barbs and Deutsch (TeeJet) Connector	2–60 GPM (7.5–225 l/min)
90-50274	801 Flow Meter with 1-1/4" Straight Hose Barbs and Conxall (Raven) Connector	2–60 GPM (7.5–225 l/min)
90-50233	801 Flow Meter with 1 1/4" NPT(F) Thread and Deutsch (TeeJet) Connector	2–60 GPM (7.5–225 l/min)
802	802 Flow Meter with 75-Series Flange and Deutsch (TeeJet) Connector	3–130 GPM (11–492 l/min)
57-10122	802 Flow Meter with 75-Series Flange and Conxall (Raven) Connector	3–130 GPM (11–492 l/min)
57-10125	802 Flow Meter with 75-Series Flange and Conxall (Raven) Connector	3–130 GPM (11–492 l/min)

TeeJet® D Series Flow Meters

D Series Flow Meters

- Simple, paddle wheel design for minimal flow restriction.
- Nylon construction for chemical resistance and durability.
- Sensor assembly easily removed for service.
- Pressure rating of 230 PSI (16 bar).

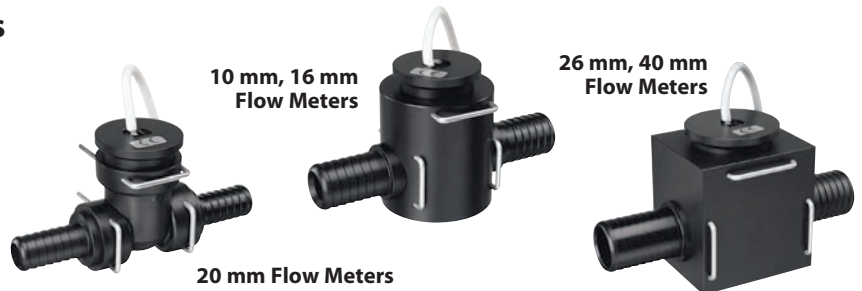

PART NUMBER	DESCRIPTION	FLOW CAPACITY
57-00079	10-mm Flow Meter, 0.5-M Cable, Deutsch (TeeJet) Connector, No Hose Barbs	0.4–22 GPM (1.5–83 l/min)
906-989	10-mm Flow Meter, 0.5-M Cable, Deutsch (TeeJet) Connector, 1/2" Hose Barbs	0.4–22 GPM (1.5–83 l/min)
90-02308	10-mm Flow Meter, 0.5-M Cable, Deutsch (TeeJet) Connector, 1/2" Hose Barbs	0.4–22 GPM (1.5–83 l/min)
906-987	10-mm Flow Meter, 10-M Cable, No Connector, No Hose Barbs	0.4–22 GPM (1.5–83 l/min)
57-00080	16-mm Flow Meter, 0.5-M Cable, Deutsch (TeeJet) Connector, No Hose Barbs	1.3–42 GPM (5–160 l/min)
907-985	16-mm Flow Meter, 0.5-M Cable, Deutsch (TeeJet) Connector, No Hose Barbs	1.3–42 GPM (5–160 l/min)
90-02310	16-mm Flow Meter, 0.5-M Cable, Deutsch (TeeJet) Connector, 1" Hose Barbs	1.3–42 GPM (5–160 l/min)
907-986	16-mm Flow Meter, 10-M Cable, No Connector, No Hose Barbs	1.3–42 GPM (5–160 l/min)
57-00081	20-mm Flow Meter, 0.5-M Cable, Deutsch (TeeJet) Connector, No Hose Barbs	5.3–66 GPM (20–250 l/min)
906-988	20-mm Flow Meter, 0.5-M Cable, Deutsch (TeeJet) Connector, No Hose Barbs	5.3–66 GPM (20–250 l/min)
906-986	20-mm Flow Meter, 10-M Cable, No Connector, No Hose Barbs	5.3–66 GPM (20–250 l/min)
57-00082	26-mm Flow Meter, 0.5-M Cable, Deutsch (TeeJet) Connector, No Hose Barbs	5.3–105 GPM (20–400 l/min)
908-988	26-mm Flow Meter, 0.5-M Cable, Deutsch (TeeJet) Connector, No Hose Barbs	5.3–105 GPM (20–400 l/min)
908-989	26-mm Flow Meter, 10-M Cable, No Connector, No Hose Barbs	5.3–105 GPM (20–400 l/min)
57-00094	40-mm Flow Meter, 0.5-M Cable, Deutsch (TeeJet) Connector, No Hose Barbs	10.5–264 GPM (40–1000 l/min)
909-988	40-mm Flow Meter, 0.5-M Cable, Deutsch (TeeJet) Connector, No Hose Barbs	10.5–264 GPM (40–1000 l/min)
909-986	40-mm Flow Meter, 10-M Cable, No Connector, No Hose Barbs	10.5–264 GPM (40–1000 l/min)



800 Series Automatic Sprayer Controls

- Large backlit display shows all spraying information at a glance.
- Single cable connection for quick hookup.
- Flow- or pressure-based regulation options provide reliability and flexibility.
- Durable, weather-resistant aluminum housing.
- Built-in planning tool helps match application rate, tip capacity and pressure.

844-AB

- Designed exclusively for orchard spraying.
- Control up to four boom sections plus master shutoff.



844-AB

844-E

- Full-featured sprayer control with industry leading ease of use.
- Five boom section switches plus master shutoff.



844E

854

- Five boom sections plus master shutoff.
- Saves summary of up to 10 jobs.
- Dual boom capability means wider ranges of speed and application rate.
- Auto tank fill allows the console to control tank filling operations.



854



700 Series Manual Sprayer Controls

- Manual sprayer control in a compact package.
- Lighted pressure gauge for night use.
- Heavy duty switches with LED indicators.
- Available in kit forms using solenoids or ball type control valves.
- 744A offered with 3 section switches and choice of 100 PSI (7 bar) or 300 PSI (20 bar) gauge.
- 744E offered with 100 PSI (7 bar) gauge and choice of 3 or 5 section switches.



744A-3



744E-5



Radion 8140 Automatic Sprayer Control

- Large 4.3" (109 mm) color touch screen display is packed with useful information, and is easy to view in both day and night conditions.
- Tank level monitoring and automatic filling function
- Built-in droplet size monitor
- Uses TeeJet 800 Series cables for quick hookup
- Available in 5, 7 or 9 boom sections plus master shutoff
- TeeJet spray nozzle database is programmed into the Radion 8140, making tip selection quick and easy
- Communication port for connection to external variable rate controls
- Designed for direct connection to TeeJet Matrix® consoles for automatic boom section control without extra devices
- Contact your local TeeJet distributor for additional information



Radion 8140

TeeJet® Field Computers

Aeros 9040 Field Computer

- Automatic rate control for liquid or granular applications, built on field proven control modules.
- Rugged enclosure with a crisp, bright 8.4" display.
- Robust guidance system supports all popular guidance modes.
- Available BoomPilot® automatic section control for improved application efficiency.
- Unique droplet size monitoring function allows real-time display of droplet size during spraying operations.
- Field coverage mapping and USB ports for easy data downloading.
- Ethernet port and Wi-Fi capability for data transfer and maximum connectivity.
- Built-in sub-meter GPS receiver, also compatible with external receivers.
- Compatible with FieldPilot® hydraulic auto steering and UniPilot® electromechanical assisted steering.
- Supports up to 8 RealView® cameras for machine and field monitoring.
- Contact your local TeeJet distributor for additional information.



Aeros 9040



DirectoValve® B Style Electric Motors and Valves

Shutoff/Control Motors

Boom Control motors are 22 RPM for 344B series (0.7 second shutoff valves) and 25 RPM for 346B and 356 series (0.6 second shutoff valves) for 12 VDC systems. Available with E or EC series motors with DIN or CABLE versions. E type motors work with DPDT (double pole, double throw) switch. EC type motors work with simple SPST (single pole, single throw) on/off switch and are compatible with all sprayer controls.

Current draw less than 2 amps (1.7 amps at 40 in.-lbs.).

Electrical connectors can be ordered with a standard number. See page 117 for more information.

Note: 2-way control motors can be rotated 180° to change the cable outlet direction on the valve. There is also an adapter to rotate motors 90°, contact your local representative for more information.

An internal fuse protects the valve and your electrical system, and it resets automatically by disconnecting power to the motor for 20 seconds.

Direct coupled visual indicator to verify position/operation. Yellow oval indicates 22 RPM motor. Yellow diamond indicates 25 RPM motor.

Cover fits snugly over the motor cavity to reduce air space and eliminate condensation. It's sealed and sonically welded to comply with the IP67 rating for submersion under water.

Permanent etched marking with complete motor number and date coded (year, month, day).

Double-wall construction of the gearbox increases strength and maintains permanent lubrication of the durable, all-metal gears.

Motor head assembly is easily detached by pulling a retaining pin allowing manual operation or easy replacement of the motor.

Available for either positive or negative switched electrical systems with a sturdy, built-in double sealed grommet and flat gasket that seals the DIN connector versions. Motor and DIN cables are made of polyurethane.



Regulating Motors

Choosing the proper regulating motor speed is important to maximizing the sprayer's performance. Three speeds are offered at this time: 1 RPM, 3 RPM and 6 RPM. The 1 RPM speed is used mostly in manual systems; it is too slow for automated rate control. The other two speeds are used in automated systems. The 3 RPM is the most popular and opens the valve to the maximum flow in about 6 seconds for the RL valve and about 10 seconds for the PR valves. The 6 RPM motor cuts those times in half.

DIN and Cable Electrical Connector

Both DIN and motor cables are made of polyurethane and are pressure extruded creating a round cable for improved sealing. Polyurethane has twice the strength and three times the tear and abrasion resistance of PVC. Motor cables include over-molded plugs that seal off the ends of cables and wires to prevent seepage. Conductor insulation uses familiar color coding of red, white and black.

DIN cable connectors are constructed of a special over molded elastomeric material that does not require a flat gasket to be sealed. The center screw is made of stainless steel.

How to Order:

Example: 38082-30, 10 ft. (3 meter) DIN cable.



DIN CABLE	CABLE
38082-05	1.5' (0.5 meter) DIN cable
38082-15	5' (1.5 meter) DIN cable
38082-30	10' (3 meter) DIN cable
38082-60	20' (6 meter) DIN cable

DIN cables are ordered separately.

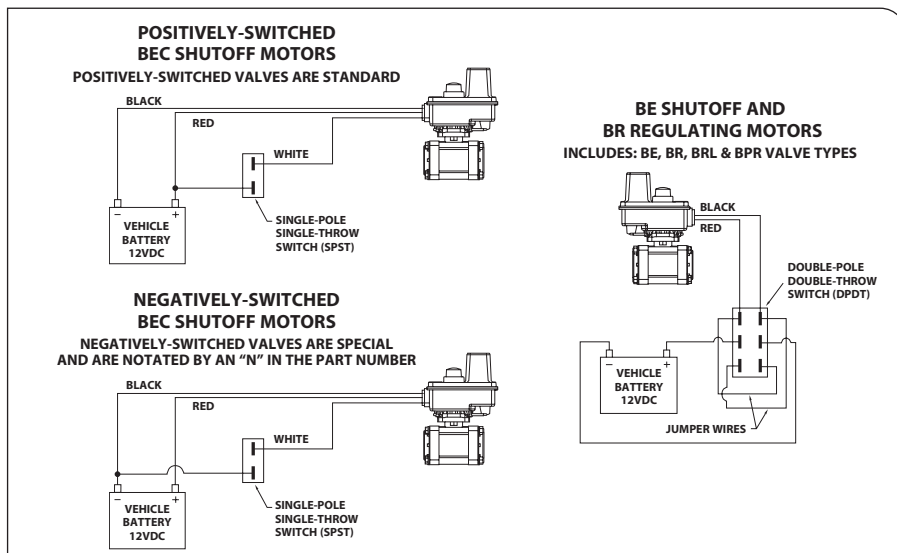



B Style Shutoff Motor Numbers

344B, 440B, 450B, 460B SERIES			CURRENT DRAW (AMPS)**	346B, 356 AND 490 SERIES			CURRENT DRAW (AMPS)**		CABLE LENGTH
BEC POSITIVE SWITCH MOTOR	*BEC NEGATIVE SWITCH MOTOR	BE SWITCH MOTOR	344B, 440B, 450B, 460B	BEC POSITIVE SWITCH MOTOR	*BEC NEGATIVE SWITCH MOTOR	BE SWITCH MOTOR	346B	356, 490	
50515-22CP03	* 50515-22CN03	* 50533-22C03	1.1	50515-25CP03	* 50515-25CN03	* 50533-25C03	1.75	2.2	1.0' (0.3 meter) cable
50515-22CP05	* 50515-22CN05	50533-22C05	1.1	50515-25CP05	* 50515-25CN05	50533-25C05	1.75	2.2	1.5' (0.5 meter) cable
50515-22CP15	* 50515-22CN15	* 50533-22C15	1.1	50515-25CP15	* 50515-25CN15	* 50533-25C15	1.75	2.2	5' (1.5 meter) cable
50515-22CP60	* 50515-22CN60	* 50533-22C60	1.1	50515-25CP60	* 50515-25CN60	* 50533-25C60	1.75	2.2	20' (6 meter) cable
50515-22DP	* 50515-22DN	* 50533-22D	1.1	50515-25DP	* 50515-25DN	* 50533-25D	1.75	2.2	DIN Electrical Connector

Items marked with "*" are non-stock items.

** Current draw is a nominal rating @ 13.8 VDC and will vary dependent upon valve usage and chemicals used.

Note: DIN cables are ordered separately.

*Bypass Valve (Normally Open) BEC Motors

344B, 440B, 450B, 460B SERIES			CURRENT DRAW (AMPS)**	346B, 356 AND 490 SERIES			CURRENT DRAW (AMPS)**		CABLE LENGTH
BEC POSITIVE SWITCH MOTOR	*BEC NEGATIVE SWITCH MOTOR	BE SWITCH MOTOR	344B, 440B, 450B, 460B	BEC POSITIVE SWITCH MOTOR	*BEC NEGATIVE SWITCH MOTOR	BE SWITCH MOTOR	346B	356, 490	
50994-22CP03	* 50994-22CN03	* 50533-22C03	1.1	50994-25CP03	* 50994-25CN03	* 50533-25C03	1.75	2.2	1.0' (0.3 meter) cable
50994-22CP05	* 50994-22CN05	50533-22C05	1.1	50994-25CP05	* 50994-25CN05	50533-25C05	1.75	2.2	1.5' (0.5 meter) cable
50994-22CP15	* 50994-22CN15	* 50533-22C15	1.1	50994-25CP15	* 50994-25CN15	* 50533-25C15	1.75	2.2	5' (1.5 meter) cable
50994-22CP60	* 50994-22CN60	* 50533-22C60	1.1	50994-25CP60	* 50994-25CN60	* 50533-25C60	1.75	2.2	20' (6 meter) cable
50994-22DP	* 50994-22DN	* 50533-22D	1.1	50994-25DP	* 50994-25DN	* 50533-25D	1.75	2.2	DIN Electrical Connector

Items marked with "*" are non-stock items.

** Current draw is a nominal rating @ 13.8 VDC and will vary dependent upon valve usage and chemicals used.

Note: DIN cables are ordered separately.

344B & 346B Regulating Motors

SPEED (RPM)	R & RL MOTOR NO.	PR MOTOR NO.	CURRENT DRAW (AMPS)**		CABLE LENGTH
			AA344B	AA346B	
1	* 50516-01C03	* 50996-01C03	0.10	0.12	1.0' (0.3 meter) cable
1	* 50516-01C05	* 50996-01C05	0.10	0.12	1.5' (0.5 meter) cable
1	* 50516-01C15	* 50996-01C15	0.10	0.12	5' (1.5 meter) cable
1	* 50516-01C60	* 50996-01C60	0.10	0.12	20' (6 meter) cable
1	* 50516-01D	* 50996-01D	0.10	0.12	DIN Electrical Connector
3	* 50516-03C03	* 50996-03C03	0.15	0.20	1.0' (0.3 meter) cable
3	* 50516-03C05	* 50996-03C05	0.15	0.20	1.5' (0.5 meter) cable
3	* 50516-03C15	* 50996-03C15	0.15	0.20	5' (1.5 meter) cable
3	* 50516-03C60	* 50996-03C60	0.15	0.20	20' (6 meter) cable
3	* 50516-03D	* 50996-03D	0.15	0.20	DIN Electrical Connector
6	* 50516-06C03	* 50996-06C03	0.43	0.50	1.0' (0.3 meter) cable
6	* 50516-06C05	* 50996-06C05	0.43	0.50	1.5' (0.5 meter) cable
6	* 50516-06C15	* 50996-06C15	0.43	0.50	5' (1.5 meter) cable
6	* 50516-06C60	* 50996-06C60	0.43	0.50	20' (6 meter) cable
6	* 50516-06D	* 50996-06D	0.43	0.50	DIN Electrical Connector

Items marked with "*" are non-stock items.

** Current draw is a nominal rating @ 13.8 VDC and will vary dependent upon valve usage and chemicals used.

Note: DIN cables are ordered separately. See page 78 for DIN cable options.



DirectoValve® Electric Regulating Valves

DirectoValve® Electric Pressure Regulating Valves

The proper regulating valve will enhance the operation of a sprayer, especially one with an automatic rate controller. While advanced electronics provide features and control, the proper regulating valve helps the system to respond quickly to input changes and functions over a wide range of application rates. Choosing the proper valve involves determining the maximum capacity required, the range of application rates and the proper motor speed.

System Capacity

A regulating valve's system requirements will depend on the application amount and the pumping capacity. Additionally, the regulating valve can be used in bypass or throttling mode. In throttling mode, the flow through the valve will be applied through the nozzles. In bypass mode, the excess flow

from the pump is recirculated. A valve that works well throughout the flow spectrum has the best chance to work in all situations.

Types of Regulating Valves

Special ball shapes make regulating valves more responsive and able to work with both high and low application rates. Most agricultural sprayers use either a

2-way ball valve or butterfly valve for regulating purposes. When considering sizing a regulating valve, the first concern is to understand the valve's flow curve to determine how efficiently the valve will regulate. Figure 1 shows typical flow curves for DirectoValve® regulating type valves. This will help to decide the type of valve to use.

Regulating Valve Flow Curves

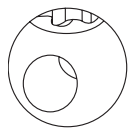
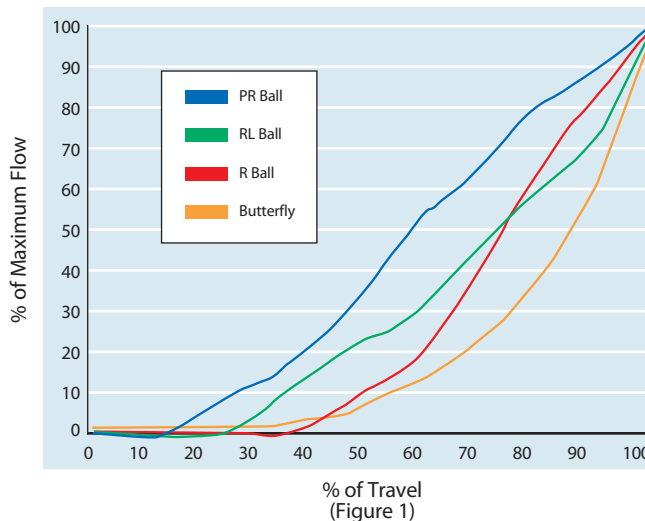

R Type Valve



Butterfly Valve



RL Valve

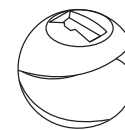

PR Valve

R Type and Butterfly Valves

As shown on the graph, the butterfly valve has the most non-linear flow curve for final 1/3 (30°) of travel leading to an increase of 75% in flow through the valve. The straight 2-way "R" ball curve is not quite as steep, with the flow through the valve increasing by 60% over the last 30° of travel. The "R" ball, however, has the additional disadvantage of not allowing significant flow during the first 1/3 of its rotation. Since a small change of rotation causes a significant change using these valves, trying to regulate large flows when the valve is two thirds to full open presents a challenge.

RL Valve

TeeJet Technologies has developed a special ball that allows the valve to start regulating earlier thus extending the regulating range. This special ball valve also increases flow and the linear characteristic of the valve during the first 3/4 of the valve cycle. The flow from the valve starts 10° earlier, than a regular R type ball and increases the flow of the RL ball during the first 70% of travel (Figure 1). The maximum capacity is about 10% less than an R type valve.

PR Valve

The PR valve uses a 3-way valve body and a ball with a wedge removed. The combination of this ball and a motor that rotates past the standard 90° results in a valve with an almost linear flow curve. The 2PR version has one outlet plugged. The 3PR version allows bypass flow to return to the tank.

As noted in Figure 1, the percentage of flow increases by approximately the amount of ball travel thus avoiding the rapid change seen with standard ball valves and butterfly valves.

Ball Type Regulating Valves

* Not available in stainless steel.

MODEL NUMBER	MAXIMUM PRESSURE	FLOW RATE AT A 5 PSI (0.34 bar) PRESSURE DROP	FLOW RATE AT A 10 PSI (0.69 bar) PRESSURE DROP
344BR-2	300 PSI (20 bar)	32 GPM (121 l/min)	45 GPM (170 /min)
344BR-3	300 PSI (20 bar)	24 GPM (91 l/min)	34 GPM (129 l/min)
344BRL-2	300 PSI (20 bar)	27 GPM (102 l/min)	38 GPM (144 l/min)
* 344BPR-2	300 PSI (20 bar)	12 GPM (45 l/min)	17 GPM (64 l/min)
* 344BPR-3	300 PSI (20 bar)	12 GPM (45 l/min)	17 GPM (64 l/min)
346BR-2	150 PSI (10 bar)	100 GPM (379 l/min)	141 GPM (534 l/min)
346BR-3	150 PSI (10 bar)	64 GPM (242 l/min)	91 GPM (344 l/min)
* 346BPR-2	150 PSI (10 bar)	53 GPM (200 l/min)	75 GPM (284 l/min)
* 346BPR-3	150 PSI (10 bar)	53 GPM (200 l/min)	75 GPM (284 l/min)



TeeJet Technologies' Flow Back valves utilize a patented design that can significantly improve the accuracy of spraying operations. Depending on sprayer configuration, standard shut off valves may allow a delay of five to ten seconds or more from the time the boom section is switched off to when the spray tips actually stop spraying. This delay can lead to over-application of spray product whenever boom sections are shut off or application to areas outside the target area. TeeJet Technologies' Flow Back feature allows for virtually instantaneous on/off spray tip control by rapidly releasing spray boom pressure. This is accomplished by diverting a small amount of liquid from the spray boom back to the spray tank. By providing precise boom shutoff and returning a small volume of liquid back to the tank, rather than mis-applying it, significant chemical savings can be achieved. Additionally, Flow Back valves are the perfect complement to automatic boom section control (ABSC) systems.

Features:

- Minimizes risk of over- or mis-application by relieving boom pressure and providing 80–95% faster tip shutoff, as compared to traditional shut off valves.
- Spray boom remains full of liquid allowing for spraying to resume instantly when valves are turned on.
- Reduces chemical expense by eliminating waste and protecting sensitive or non-target areas from overspray.
- Ideal companion for Automatic Boom Section Control (ABSC) systems, but suitable for use with any automatic or manual spray controller.
- Easy installation – requires only a single Flow Back return line to tank. No additional wiring or sensors required.
- Flow Back return line must have unrestricted flow to top of tank to ensure optimal sprayer performance. See page 157 for Flow Back plumbing diagram.
- Compatible with a wide variety of sprayer types, sizes and control systems.
- Flow Back configuration is available on 430, 450 and 460 manifolds. Select the best manifold based on maximum operating pressure, boom flow requirements, and mounting preferences.
- For further information please contact your local TeeJet Technologies distributor or sales representative.



How Flow Back Valves Work

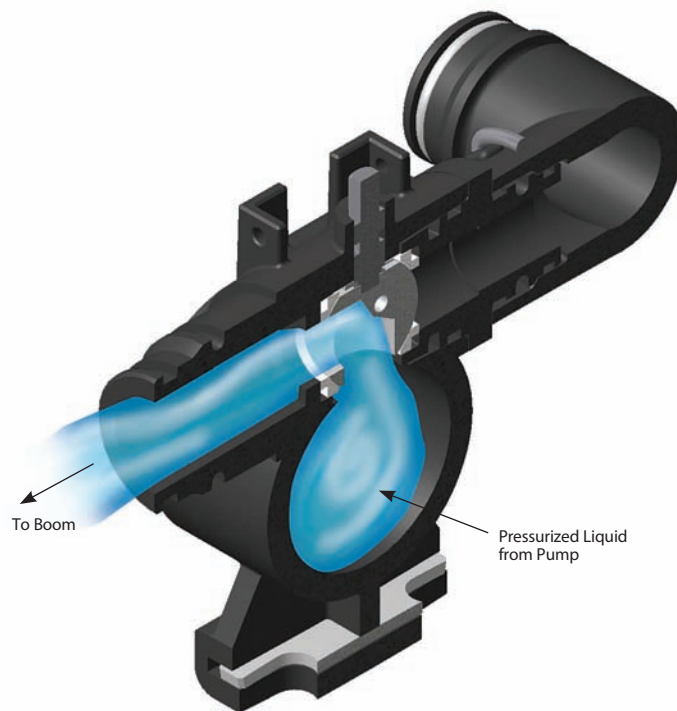

Flow Back Valve in Open Position

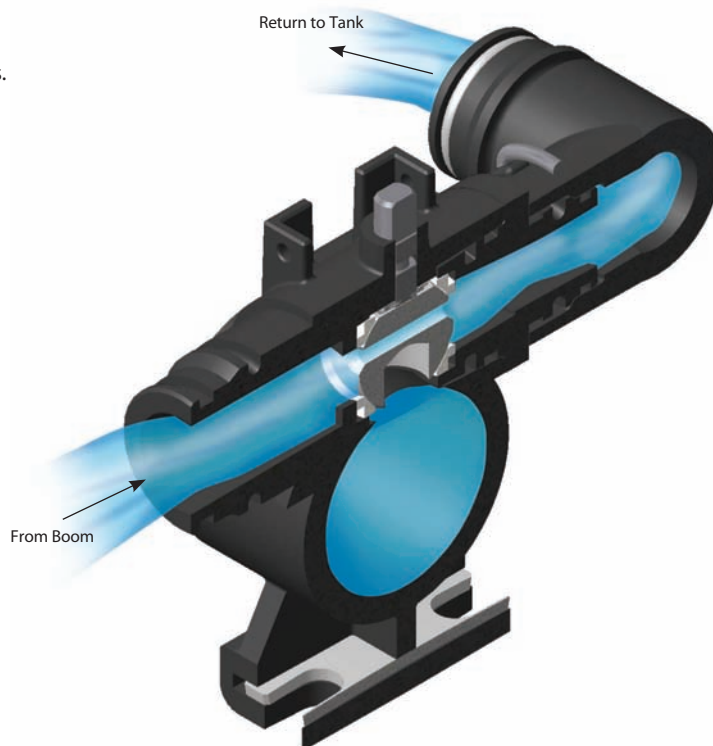

Flow Back Valve in Closed Position



344B and 346B Pressure Regulating Ball Valves

The 340 series electrical regulating valves are designed to produce linear flow regulation and shutoff control in agricultural applications. Both models are available in several styles and motor speeds to accommodate different types of applications.

Features:

- Available in 2-way and 3-way versions.
- Available in 1, 3, or 6 RPM motor speeds. Note: The PR versions cycle time is double that of an R or RL version.
- Two-wire lead provides easy installation with 12 VDC systems.
- Low power consumption, less than 1 amp.
- Offered in a variety of inlet/outlet connections. See pages 114–116 for additional information and options.
- Wetted parts are Nylon, polypropylene, stainless steel, Teflon®, and Viton®.
- See pages 78–79 for additional information on B style motors.

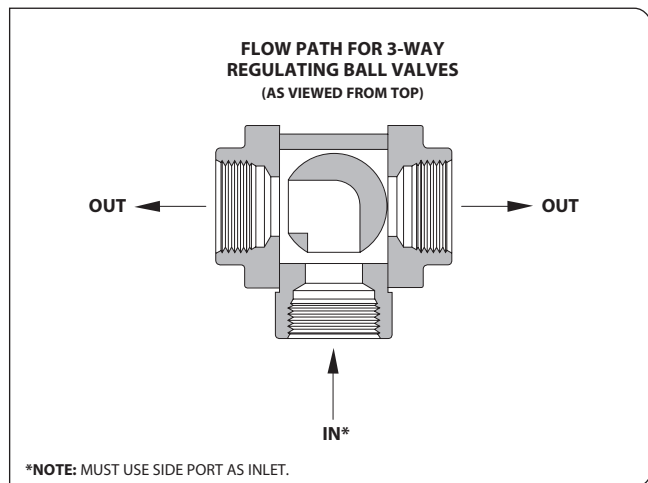

R & RL Series



344 BPR Series



346 R Series



346 BPR Series

Butterfly Valve

AA(B)244C-3/4 Remote Control Electric Regulating Butterfly Valve

The AA244C remote control electric regulation valve has been specifically designed to provide remote pressure control in agricultural applications using DirectoValve AA144A or AA145 solenoid shutoff valves.

Features:

- Unrestricted flow when wide open – Flow Rate: 28 GPM (106 l/min) at 5 PSI (0.34 bar) drop, 40 GPM (151 l/min) at 10 PSI (0.69 bar) pressure drop.
- Bypass flow rate: 2 GPM (7.5 l/min) @ 10 PSI (0.7 bar).

- Operates in 12 VDC system and may be controlled by a double-pole double-throw spring-centered switch.
- Maximum operating pressure of 100 PSI (7 bar).
- Two-wire lead for use in 12 VDC system.
- 3/4" (F) NPT or BSPT connections.
- Easy installation (flows either direction).
- Good corrosion resistance.
- Low current draw (0.10 AMP).
- 20 second response time.



How to order:

Specify model number.
Example: AA(B)244C-3/4
(B) = BSPT



Sample Valve Part Number:

(B)344BRL-2FS-01C15AB

OUTLET THREADS	
PART CODE	DESCRIPTION
BLANK	ALL THREADS TO BE NPT (IF EQUIPPED)
(B)	ALL THREADS TO BE BSPT (IF EQUIPPED)

MODEL SPECIFICATIONS	
PART CODE	DESCRIPTION
344B/346B	REGULATING VALVE

MOTOR SPECIFICATIONS	
PART CODE	DESCRIPTION
R	REGULATING VALVE
RL	LINEAR REGULATING VALVE (344 SERIES ONLY)
*PR	PRESSURE REGULATING VALVE

*Not available in stainless steel.

VALVE TYPES	
PART CODE	DESCRIPTION
2	2-WAY VALVE
3	3-WAY VALVE (PR & R ONLY)

END CAPS OR OUTLET FITTINGS	
PART CODE	DESCRIPTION
3	3/4" PIPE THREAD (344 SERIES ONLY)
4	1" PIPE THREAD (344 SERIES ONLY)
5	1 1/4" PIPE THREAD (346 SERIES ONLY)
6	1 1/2" PIPE THREAD (346 SERIES ONLY)
Q	QUICK CONNECT (344 SERIES ONLY)
F	50 SERIES FLANGE
F75	75 SERIES FLANGE (346 SERIES ONLY)

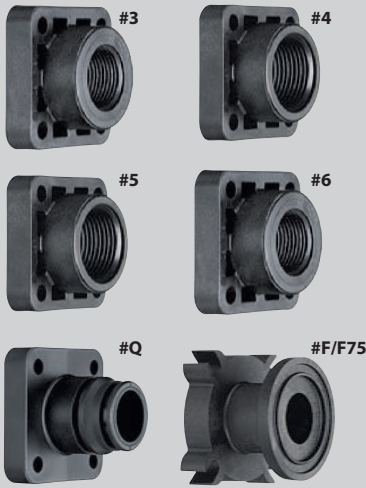

INLET/OUTLET REQUIRED CONNECTIONS
THE INLET/OUTLET FITTINGS ARE ORDERED SEPARATELY

- **3, 4, 5, 6:** When ordering 3/4" (3), 1" (4), 1 1/4" (5) or 1 1/2" (6) threaded NPT or BSPT inlet/outlet type valve connections, the inlets and outlets will be included during assembly.
- **F:** When ordering F or F75 (flange) type valve connections, the inlet/outlet fittings are ordered separately. Clamps and flange fittings are required. See pages 114–115 for flange fitting options.
- **Q:** When ordering QC (Quick Connect) hose barb type valve fittings, the inlet/outlet connections are ordered separately. Two 45529 QC fittings are required for 2-way valves and three each for 3-way valves. See page 116 for QC options.

Note: Many valve configurations are possible by mixing and matching flange fittings.

WIRING CONNECTORS	
SPECIFY ELECTRICAL CONNECTOR STYLE AND PIN-OUTS. IF NO CONNECTOR IS NEEDED LEAVE BLANK.	
See page 117 for electrical connectors and codes.	

MOTOR CABLES	
PART CODE	DESCRIPTION
C	0.5-METER CABLE
* C03	0.3-METER CABLE
* C15	1.5-METER CABLE
* C60	6.0-METER CABLE
D	DIN CONNECTOR

Items marked with "*" are non-stock items. Please contact your regional sales office for ordering and availability information.

Note: DIN cables must be ordered separately. See page 78 for DIN cables.

MOTOR SPEEDS	
PART CODE	DESCRIPTION
01	1 RPM (18 SECOND CYCLE TIME) MOTOR
03	3 RPM (6 SECOND CYCLE TIME) MOTOR
06	6 RPM (3 SECOND CYCLE TIME) MOTOR

Note: PR series cycle times are doubled.

BALL MATERIAL SPECIFICATIONS	
PART CODE	DESCRIPTION
BLANK	POLYPROPYLENE BALL
S	STAINLESS STEEL BALL (R & RL SERIES ONLY)

REPAIR KITS	
AB344AE-KIT	AB346B-KIT

Note: AB344AE-KIT for 344A&B Valves



DirectoValve® 344 Series Electric Shutoff Valves

344B shutoff ball valves are available with E or EC series motors and with cable or DIN electrical connections. See pages 78–79 for more information on DirectoValve motors.

Features:

- 22 RPM, 0.7 second shutoff fully open to close.
- Flexible inlet/outlets provide quick simple plumbing for a single valve. See page 85 for more information.
- Available in 2-way or 3-way versions. 2-way valves allow complete shutoff while the 3-way valves divert flow to a bypass line when boom controls are shut off.
- Stainless steel stem with optional polypropylene or stainless steel ball.
- Maximum pressure rating is 300 PSI (20 bar).
- The flow rate for the 344BEC 2-way valve is 32 GPM (121 l/min) flow rate with a 5 PSI (0.34 bar) pressure drop, 45 GPM (170 l/min) at a 10 PSI (0.69 bar) pressure drop.
- The flow rate for the 344BEC 3-way valve is 24 GPM (91 l/min) with a 5 PSI (0.34 bar) pressure drop, 34 GPM (129 l/min) at a 10 PSI (0.69 bar) pressure drop.
- Wetted parts are Nylon, Teflon®, polypropylene, stainless steel and Viton®.



**344BEC-24-C
2-Way Valve**
(rear view)

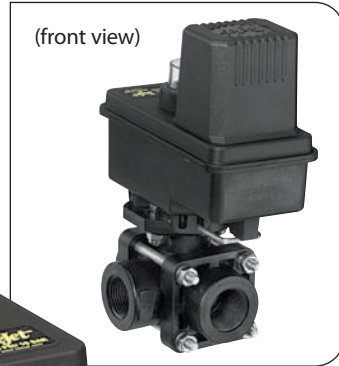

**344BEC-33-C
3-Way Valve**
(rear view)

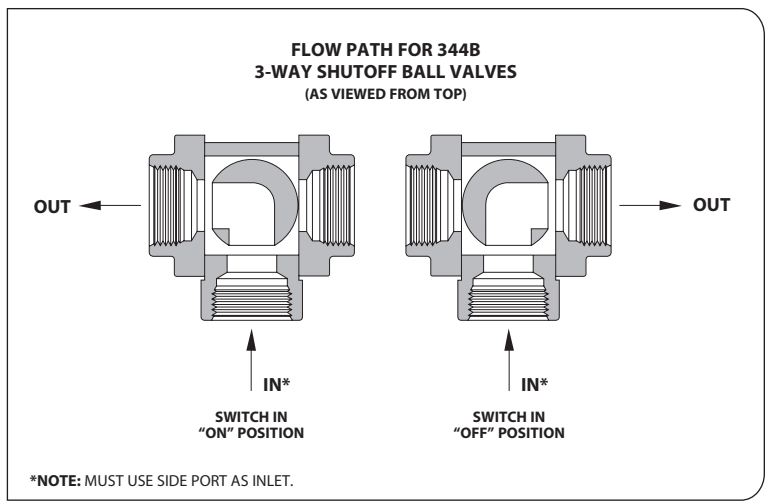



Sample Valve Part Number:

(B)344BEC-2FS-CN15AB

OUTLET THREADS	
PART CODE	DESCRIPTION
BLANK	ALL THREADS TO BE NPT (IF EQUIPPED)
(B)	ALL THREADS TO BE BSPT (IF EQUIPPED)

MODEL SPECIFICATION	
PART CODE	DESCRIPTION
344B	BALL VALVE

MOTOR SPECIFICATIONS		
PART CODE	SWITCH	DESCRIPTION
E	DPDT	22 RPM, 0.7 SECOND SHUTOFF VALVE
EC	SPST	

VALVE TYPES	
PART CODE	DESCRIPTION
2	2-WAY VALVE
3	3-WAY VALVE

END CAPS OR OUTLET FITTINGS	
PART CODE	DESCRIPTION
3	3/4" PIPE THREAD
4	1" PIPE THREAD
Q	QUICK CONNECT
F	50 SERIES FLANGE

WIRING CONNECTORS
SPECIFY ELECTRICAL CONNECTOR STYLE AND PIN-OUTS. IF NO CONNECTOR IS NEEDED LEAVE BLANK.
See page 117 for electrical connectors and codes.

MOTOR CABLES	
PART CODE	DESCRIPTION
C	POSITIVELY SWITCHED w/ 0.5-METER CABLE
CN	NEGATIVELY SWITCHED w/ 0.5-METER CABLE
* C03	POSITIVELY SWITCHED w/ 0.3-METER CABLE
* CN03	NEGATIVELY SWITCHED w/ 0.3-METER CABLE
* C15	POSITIVELY SWITCHED w/ 1.5-METER CABLE
* CN15	NEGATIVELY SWITCHED w/ 1.5-METER CABLE
* C60	POSITIVELY SWITCHED w/ 6.0-METER CABLE
* CN60	NEGATIVELY SWITCHED w/ 6.0-METER CABLE
D	POSITIVELY SWITCHED w/ DIN CONNECTOR
DN	NEGATIVELY SWITCHED w/ DIN CONNECTOR

Items marked with "*" are non-stock items. Please contact your regional sales office for ordering and availability information.

Note: DIN cables must be ordered separately. See page 78 for DIN cables.

INLET/OUTLET REQUIRED CONNECTIONS
THE INLET/OUTLET FITTINGS ARE ORDERED SEPARATELY

- 3, 4:** When ordering 3/4" (3) or 1" (4) threaded NPT or BSPT inlet/outlet type valve connections, the inlets and outlets will be completed during the ordering process.
- F:** When ordering F (flange) type valve connections, the inlet/outlet fittings are ordered separately. Two 50 series clamps and flange fittings are required for 2-way valves and three each for 3-way valves. See pages 114–115 for flange fitting options.
- Q:** When ordering QC (Quick Connect) hose barb type valve fittings, the inlet/outlet connections are ordered separately. Two 45529 QC fittings are required for 2-way valves and three each for 3-way valves. See page 116 for QC options.

Note: Many valve configurations are possible by mixing and matching flange fittings.

BALL MATERIAL SPECIFICATIONS	
PART CODE	DESCRIPTION
BLANK	POLYPROPYLENE BALL
S	STAINLESS STEEL BALL

REPAIR KIT
AB344AE-KIT for 344A&B Valves



DirectoValve® 346 Series Shutoff Valves

346BEC shutoff ball valves are available with E or EC series motors with cable or DIN electrical connections. See page 78 for more information on DirectoValve motors.

Features:

- 25 RPM, 0.6 second shutoff fully open to close.
- Available in 2-way or 3-way versions. 2-way valves allow complete shutoff while the 3-way valves divert flow to a bypass line when boom controls are shut off.
- The flow rate for the 346BEC 2-way valve is 100 GPM (379 l/min) with 5 PSI (0.34 bar) pressure drop, 141 GPM (534 l/min) with 10 PSI (0.69 bar) pressure drop.
- The flow rate for the 346BEC 3-way valve is 64 GPM (242 l/min) with a 5 PSI (0.34 bar) pressure drop, 91 GPM (344 l/min) with 10 PSI (0.69 bar) pressure drop.
- Polypropylene ball with stainless steel stem.
- Maximum pressure rating of 150 PSI (10 bar).
- Available with 1¼", 1½" NPT or BSPT (F) threads or 50 series flange fittings.
- Wetted parts made of corrosion-resistant materials, glass-reinforced polypropylene, Teflon®, stainless steel and Viton®.



346BEC-25-C Valve
(rear view)



346BEC-35-C Valve
(rear view)

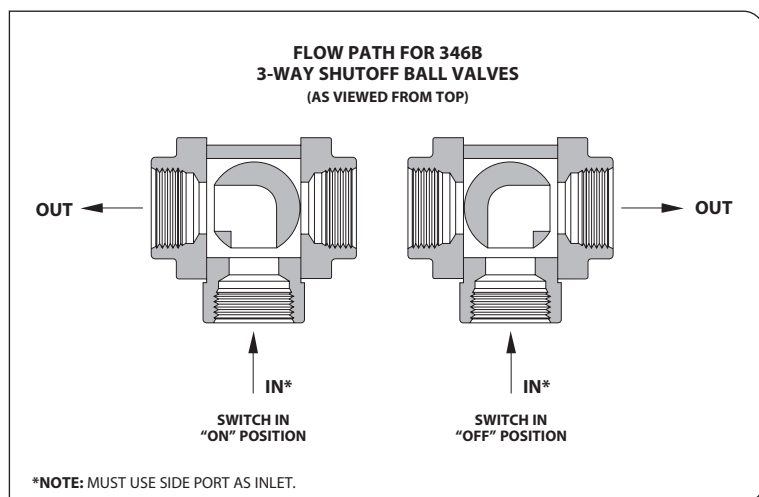



Sample Valve Part Number:

(B)346BEC-25S-CN15AB

OUTLET THREADS	
PART CODE	DESCRIPTION
BLANK	ALL THREADS TO BE NPT (IF EQUIPPED)
(B)	ALL THREADS TO BE BSPT (IF EQUIPPED)

MODEL SPECIFICATION	
PART CODE	DESCRIPTION
346B	BALL VALVE

MOTOR SPECIFICATIONS		
PART CODE	SWITCH	DESCRIPTION
E	DPDT	25 RPM, 0.6 SECOND SHUTOFF VALVE
EC	SPST	

VALVE TYPES	
PART CODE	DESCRIPTION
2	2-WAY VALVE
3	3-WAY VALVE

END CAPS OR OUTLET FITTINGS	
PART CODE	DESCRIPTION
5	1¼" PIPE THREAD
6	1½" PIPE THREAD
F	50 SERIES FLANGE
F75	75 SERIES FLANGE

WIRING CONNECTORS
SPECIFY ELECTRICAL CONNECTOR STYLE AND PIN-OUTS. IF NO CONNECTOR IS NEEDED LEAVE BLANK.
See page 117 for electrical connectors and codes.

MOTOR CABLES	
PART CODE	DESCRIPTION
C	POSITIVELY SWITCHED w/ 0.5-METER CABLE
CN	NEGATIVELY SWITCHED w/ 0.5-METER CABLE
* C03	POSITIVELY SWITCHED w/ 0.3-METER CABLE
* CN03	NEGATIVELY SWITCHED w/ 0.3-METER CABLE
* C15	POSITIVELY SWITCHED w/ 1.5-METER CABLE
* CN15	NEGATIVELY SWITCHED w/ 1.5-METER CABLE
* C60	POSITIVELY SWITCHED w/ 6.0-METER CABLE
* CN60	NEGATIVELY SWITCHED w/ 6.0-METER CABLE
D	POSITIVELY SWITCHED w/ DIN CONNECTOR
DN	NEGATIVELY SWITCHED w/ DIN CONNECTOR

Items marked with "*" are non-stock items. Please contact your regional sales office for ordering and availability information.

Note: DIN cables must be ordered separately. See page 78 for DIN cables.

INLET/OUTLET REQUIRED CONNECTIONS
THE INLET/OUTLET FITTINGS ARE ORDERED SEPARATELY

- **5, 6:** When ordering 1¼" (5) or 1½" (6) threaded NPT or BSPT inlet/outlet type valve connections, the valve will be completed during the ordering process.
- **F:** When ordering F or F75 (flange) type valve connections, the inlet/outlet fittings are ordered separately. Two clamps and flange fittings are required for 2-way valves and three each for 3-way valves. See pages 114–115 for flange fitting options.

Note: Many valve configurations are possible by mixing and matching flange fittings.

BALL MATERIAL SPECIFICATIONS	
PART CODE	DESCRIPTION
BLANK	POLYPROPYLENE BALL
S	STAINLESS STEEL BALL (2-WAY VALVE ONLY)

REPAIR KIT
AB346B-KIT



DirectoValve® 356 Series Flanged Shutoff Valves

The 356BEC DirectoValve control valve delivers performance and dependability. The trunnion-style valve is a hard-working, commercial-duty control valve made to go the distance. It combines dozens of design features into a control valve that will respond quickly and last longer than other valves.

356BEC shutoff ball valves are available with E or EC series motors with cable or DIN electrical connections. See page 78 for more information on DirectoValve motors.

Features:

- 25 RPM, 0.6 second shutoff fully open to close.
- Flow rate is 100 GPM (379 l/min) with a 5 PSI (0.34 bar) pressure drop, 141 GPM (534 l/min) with a 10 PSI (0.69 bar) pressure drop.
- Maximum pressure rating of 150 PSI (10 bar).
- Wetted parts are polypropylene, stainless steel, carbon-filled Teflon®, Viton® and Ryton®.
- 50 series flange fittings reduce leaks and allow various inlet/outlet connections. See pages 114–115 for more information.



(front view)



356BEC-C Valve
(rear view)

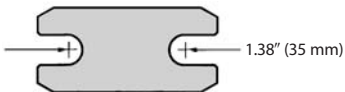

Mounting foot pattern
for 5/16" (8 mm) bolts.

Wear-resistant, carbon-filled Teflon seal improves durability and minimizes the potential for leakage.

Fasteners and mounting foot made of 303 stainless steel to prevent corrosion, provide strength and provide easy mounting. A 5/16" or 8 mm bolt can be used to mount the valve.

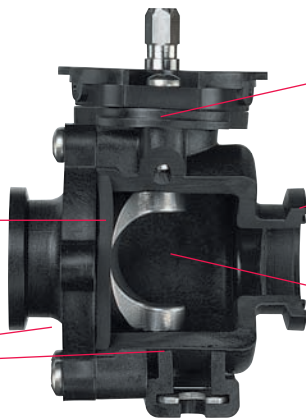

Bearings above and below the ball maintain precise position and assure long life.

TeeJet® 50 series flanged fittings at the inlet and outlet permit easy attachment of hoses or to a manifold. It's compatible with other flanged fittings on the market.

Uniquely shaped, 316 stainless steel ball, polished for longer life, is the heart of this valve. Material doesn't get trapped as easily because the valve is self-cleaning.



Sample Valve Part Number:

356BEC-CN15AB

MODEL SPECIFICATION	
PART CODE	DESCRIPTION
356B	356 BALL VALVE

MOTOR SPECIFICATIONS		
PART CODE	SWITCH	DESCRIPTION
E	DPDT	25 RPM, 0.6 SECOND SHUTOFF VALVE
EC	SPST	

MOTOR CABLES	
PART CODE	DESCRIPTION
C	POSITIVELY SWITCHED w/ 0.5-METER CABLE
CN	NEGATIVELY SWITCHED w/ 0.5-METER CABLE
* C03	POSITIVELY SWITCHED w/ 0.3-METER CABLE
* CN03	NEGATIVELY SWITCHED w/ 0.3-METER CABLE
* C15	POSITIVELY SWITCHED w/ 1.5-METER CABLE
* CN15	NEGATIVELY SWITCHED w/ 1.5-METER CABLE
* C60	POSITIVELY SWITCHED w/ 6.0-METER CABLE
* CN60	NEGATIVELY SWITCHED w/ 6.0-METER CABLE
D	POSITIVELY SWITCHED w/ DIN CONNECTOR
DN	NEGATIVELY SWITCHED w/ DIN CONNECTOR

WIRING CONNECTORS

SPECIFY ELECTRICAL CONNECTOR STYLE AND PIN-OUTS. IF NO CONNECTOR IS NEEDED LEAVE BLANK.

See page 117 for electrical connectors and codes.



INLET/OUTLET REQUIRED CONNECTIONS
THE INLET/OUTLET FITTINGS ARE ORDERED SEPARATELY

- **F:** Two 50 series clamps and flange fittings are required. See pages 114–115 for flange fitting options.
- **Q:** QC (Quick Connect) hose barb type valve fittings are not normally used due to flow limitations. See page 116 for more information on QC fittings.

Note: Many valve configurations are possible by mixing and matching flange fittings.

Items marked with "*" are non-stock items. Please contact your regional sales office for ordering and availability information.

Note: DIN cables must be ordered separately. See page 78 for DIN cables.

REPAIR KIT

AB356-KIT



DirectoValve® Normally-Open (Bypass) Valves

The 344BEC, 346BEC and 356BEC valves are available in a normally-open configuration. Unlike standard shutoff ball valves, which are normally closed, normally-open valves will be in the closed position when the signal line (white wire or DIN terminal 2) is energized (+12 VDC) and will be in the open position when the signal is de-energized.

Features:

- Normally-open valves are wired in the identical manner to normally-closed, BEC style valves and operated by a single-pole single-throw (SPST) switch.
- Refer to the standard DirectoValve shutoff valve pages for typical features and specifications of a dump valve.



56602-11
(346BEC, see page 86)



56600-11
(344BEC, see page 84)

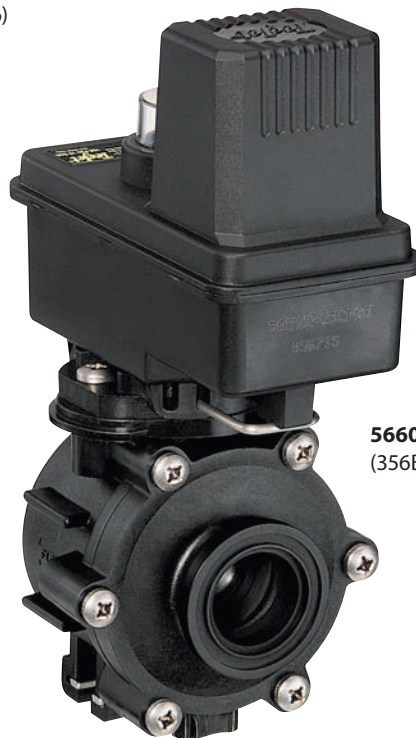

56604-11
(356BEC, see page 88)



Sample Valve Part Number:

(B)56600-11-2FS-CN15AB

OUTLET THREADS (FOR 344 & 346)

PART CODE	DESCRIPTION
BLANK	ALL THREADS TO BE NPT (IF EQUIPPED)
(B)	ALL THREADS TO BE BSPT (IF EQUIPPED)

MODEL SPECIFICATIONS (FOR 344, 346 & 356)

PART CODE	DESCRIPTION
56600	344BEC BALL VALVE
56602	346BEC BALL VALVE
56604	356BEC BALL VALVE

VALVE TYPES (FOR 344 & 346)

PART CODE	DESCRIPTION
2	2-WAY VALVE
3	3-WAY VALVE

END CAPS OR OUTLET FITTINGS (FOR 344 & 346)

PART CODE	DESCRIPTION
3	3/4" PIPE THREAD (344 ONLY)
4	1" PIPE THREAD (344 ONLY)
5	1 1/4" PIPE THREAD (346 ONLY)
6	1 1/2" PIPE THREAD (346 ONLY)
Q	QUICK CONNECT (344 ONLY)
F	50 SERIES FLANGE
F75	75 SERIES FLANGE (346 ONLY)

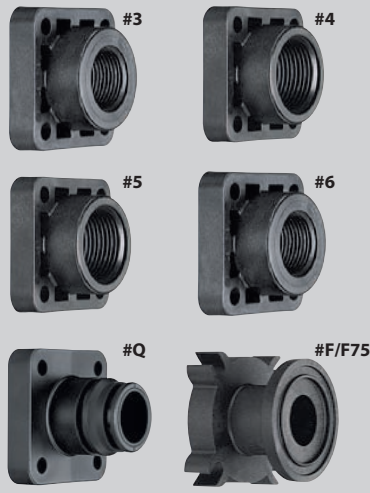

WIRING CONNECTORS (FOR 344, 346 & 356)

SPECIFY ELECTRICAL CONNECTOR STYLE AND PIN-OUTS. IF NO CONNECTOR IS NEEDED LEAVE BLANK.

See page 117 for electrical connectors and codes.

MOTOR CABLES (FOR 344, 346 & 356)

PART CODE	DESCRIPTION
C	POSITIVELY SWITCHED w/ 0.5-METER CABLE
CN	NEGATIVELY SWITCHED w/ 0.5-METER CABLE
* C03	POSITIVELY SWITCHED w/ 0.3-METER CABLE
* CN03	NEGATIVELY SWITCHED w/ 0.3-METER CABLE
* C15	POSITIVELY SWITCHED w/ 1.5-METER CABLE
* CN15	NEGATIVELY SWITCHED w/ 1.5-METER CABLE
* C60	POSITIVELY SWITCHED w/ 6.0-METER CABLE
* CN60	NEGATIVELY SWITCHED w/ 6.0-METER CABLE
D	POSITIVELY SWITCHED w/ DIN CONNECTOR
DN	NEGATIVELY SWITCHED w/ DIN CONNECTOR

Items marked with "*" are non-stock items. Please contact your regional sales office for ordering and availability information.

Note: DIN cables must be ordered separately. See page 78 for DIN cables.

INLET/OUTLET REQUIRED CONNECTIONS
THE INLET/OUTLET FITTINGS ARE ORDERED SEPARATELY

- **3, 4, 5, 6:** When ordering 3/4" (3), 1" (4), 1 1/4" (5) or 1 1/2" (6) threaded NPT or BSPT inlet/ outlet type valve connections, the inlets and outlets will be included during assembly.
- **F:** When ordering F or F75 (flange) type valve connections, the inlet/outlet fittings are ordered separately. Clamps and flange fittings are required. See pages 114-115 for flange fitting options.
- **Q:** When ordering QC (Quick Connect) hose barb type valve fittings, the inlet/outlet connections are ordered separately. Two 45529 QC fittings are required for 2-way valves and three each for 3-way valves. See page 116 for QC options.

Note: Many valve configurations are possible by mixing and matching flange fittings.

BALL MATERIAL SPECIFICATIONS (FOR 344 & 346)

PART CODE	DESCRIPTION
BLANK	POLYPROPYLENE BALL
S	STAINLESS STEEL BALL

REPAIR KIT

- AB344AE-KIT
- AB346B-KIT



DirectoValve® 430 Series 2-Way Manifold

The 430 series 2-way shutoff manifold offers the proven reliability of a ball valve in a very compact design. The 430 provides simple, dependable on/off control and can be configured to suit the needs of a wide variety of sprayers.

Features:

- ¼-turn ball valve design for positive shutoff.
- 0.6 second shutoff time fully open to fully closed.
- Less than 0.5 amp steady state current draw at 12 VDC.
- Motor assembly features built-in mini-DIN electrical connector and is IP67 rated.
- Motor available in EC (single pole, single throw) or E (double pole, double throw) configurations for use with a variety of controls.
- All metal gear train with stainless steel ball and stem provide excellent wear life.
- Large Quick Connect inlet can be configured in a variety of ways—see page 116 for options.
- Quick Connect outlet fitting for rapid attachment and removal of boom lines—see page 116 for options.
- Maximum pressure rating of 215 PSI (15 bar).
- The flow rate is 11.7 GPM (44 l/min) at a 5 PSI (0.34bar) pressure drop, 16.5 GPM (63 l/min) at a 10 PSI (0.69 bar) drop.
- Wetted parts are polypropylene, stainless steel, Viton® and PTFE.
- Integral mounting brackets allow for easy installation.
- Also available in 3-way and Flow Back versions.



430 2-Way Single Valve



435 2-Way Manifold

DirectoValve® 430 Series 3-Way Manifold



The 430 series 3-way shutoff manifold features a 3-way, metered bypass ball valve design. The 3-way configuration, commonly used with positive displacement pumps, allows a constant system pressure to be maintained regardless of the valve being in the on or off position.

Features:

- ¼-turn ball valve design for positive shutoff.
- 0.6 second shutoff time fully open to fully closed.
- User configurable bypass settings with markings on dial for quick and easy adjustment.
- Less than 0.5 amp steady state current draw at 12 VDC.
- Motor assembly features built-in mini-DIN electrical connector and is IP67 rated.
- Motor available in EC (single pole, single throw) or E (double pole, double throw) configurations for use with a variety of controls.
- All metal gear train with stainless steel ball and stem provide excellent wear life.
- Large Quick Connect inlet can be configured in a variety of ways—see page 116 for options.
- Quick Connect fittings used on outlets and 3-way return line allow for rapid attachment and removal of boom lines—see page 116 for options.
- Maximum pressure rating of 215 PSI (15 bar).
- The flow rate is 11.7 GPM (44 l/min) at a 5 PSI (0.34bar) pressure drop, 16.5 GPM (63 l/min) at a 10 PSI (0.69 bar) drop.
- Wetted parts are polypropylene, stainless steel, Viton® and PTFE.
- Integral mounting brackets allow for easy installation.
- Also available in 2-way and Flow Back versions.



430 3-Way Single Valve



435 3-Way Manifold



DirectoValve® 430 Series Flow Back Manifold

The 430 series Flow Back manifold utilizes a unique ball design that relieves trapped pressure in the boom. This provides instant shutoff at nozzles and eliminates application problems resulting from nozzles continuing to spray after the boom section has been switched off. Flow back technology is the perfect complement to automatic boom section control and growers can often realize significant chemical savings.

Features:

- ¼-turn ball valve design for positive shutoff.
- 0.6 second shutoff time fully open to fully closed.
- Liquid from flow back line must be returned, unrestricted, to top of tank.
- Less than 0.5 amp steady state current draw at 12 VDC.
- Motor assembly features built-in mini-DIN electrical connector and is IP67 rated.
- Motor available in EC (single pole, single throw) or E (double pole, double throw) configurations for use with a variety of controls.
- All metal gear train with stainless steel ball and stem provide excellent wear life.
- Large Quick Connect inlet can be configured in a variety of ways—see page 116 for options.
- Quick Connect fittings used on outlet and flow back port for rapid attachment and removal of boom lines—see page 116 for options.
- Maximum pressure rating of 215 PSI (15 bar).
- The flow rate is 9.2 GPM (35 l/min) at a 5 PSI (0.34 bar) pressure drop, 13.7 GPM (53 l/min) at a 10 PSI (0.69 bar) pressure drop.
- Wetted parts are polypropylene, stainless steel, Viton® and PTFE.
- Integral mounting brackets allow for easy installation
- Also available in 2-way and 3-way versions.



430 Flow Back Single Valve



435 Flow Back Manifold



Sample Valve Part Number:

437EC-3FBF75-D

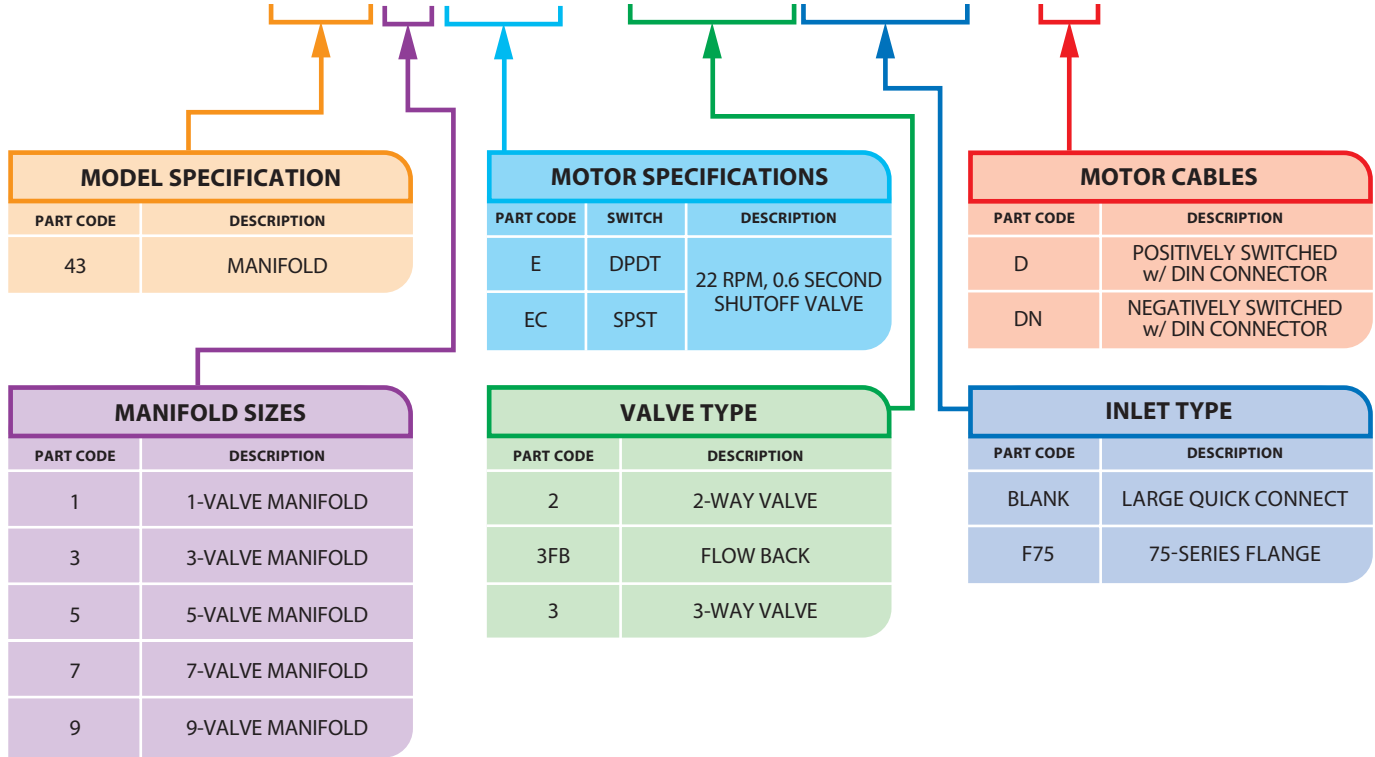

Other manifold sizes are available.

Mini-DIN Cable Assembly Part Code Example:

58480EC-15-VX

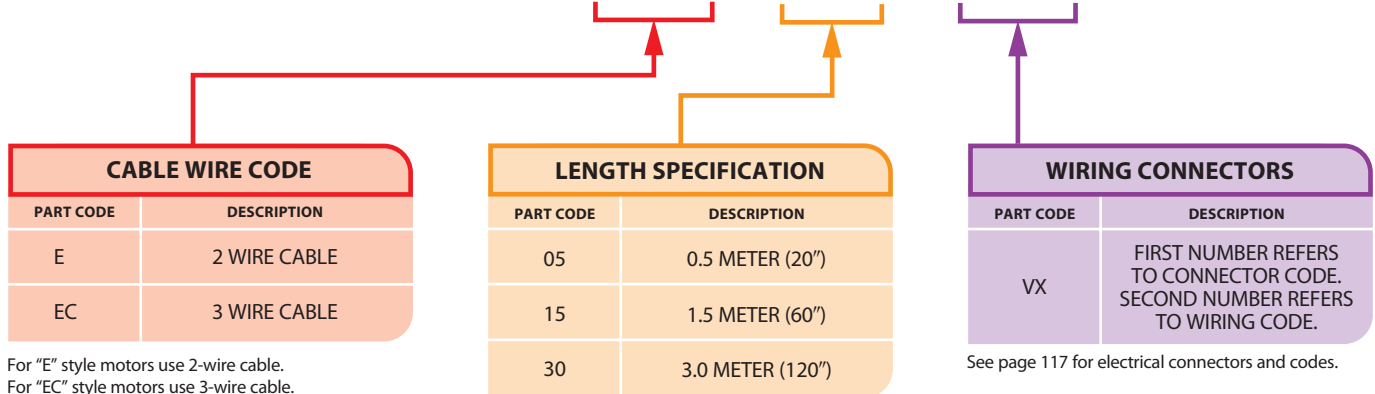

For "E" style motors use 2-wire cable.
For "EC" style motors use 3-wire cable.

See page 117 for electrical connectors and codes.



DirectoValve® Control Unit for TeeJet Controllers

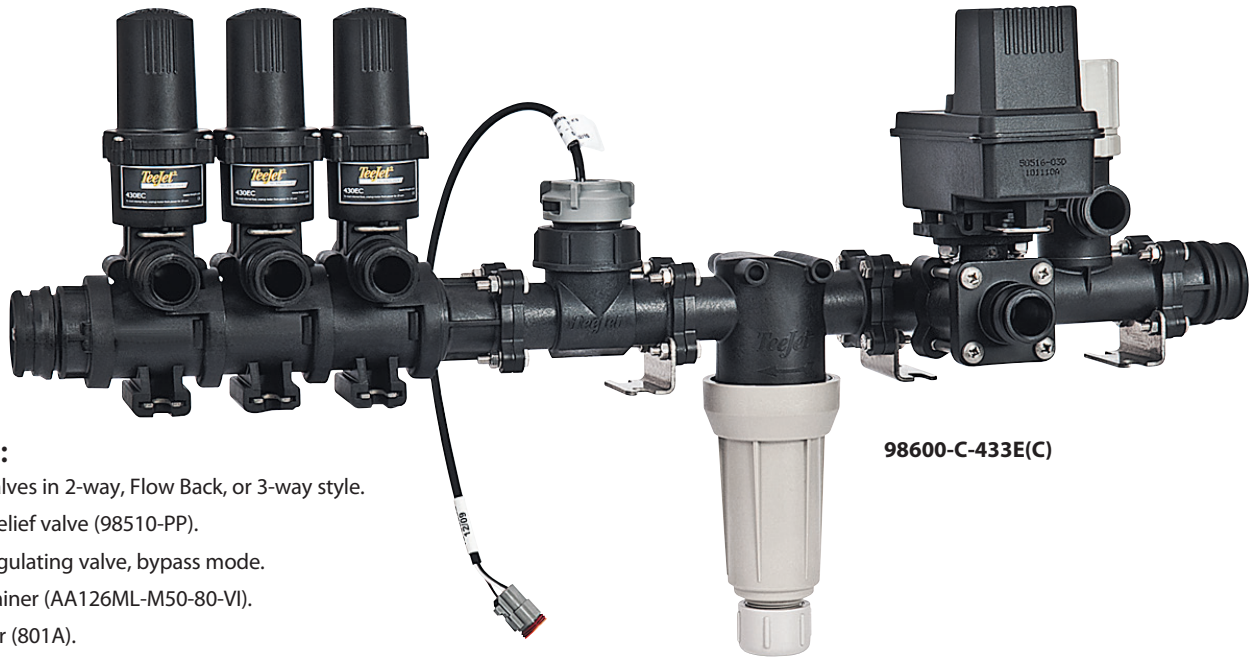

98600-C-433E(C)

Includes:

- Section valves in 2-way, Flow Back, or 3-way style.
- Pressure relief valve (98510-PP).
- Electric regulating valve, bypass mode.
- Liquid strainer (AA126ML-M50-80-VI).
- Flowmeter (801A).

MODEL NUMBER	VALVE SECTIONS	VALVE TYPE	PRESSURE	FLOW PER SECTION
98600-C-433E(C)-2	3	2-Way	215 PSI (15 bar)	11.7 GPM (5 PSI Pressure Drop) 44 l/min (0.34 bar Pressure Drop)
98601-C-435E(C)-3FB	5	Flow Back	215 PSI (15 bar)	9.2 GPM (5 PSI Pressure Drop) 35 l/min (0.34 bar Pressure Drop)
98602-C-434E(C)-3	4	3-Way	215 PSI (15 bar)	11.7 GPM (5 PSI Pressure Drop) 44 l/min (0.34 bar Pressure Drop)

Note: Valves can be ordered in 1-9 sections configuration. For inlet and outlet connections refer to page 116.



98601-B-433E(C)

Includes:

- Section valves in 2-way, Flow Back, or 3-way style.
- Pressure relief valve (98510-PP).
- Electric regulating valve, bypass mode.
- Liquid strainer (AA126ML-M50-80-VI).

MODEL NUMBER	VALVE SECTIONS	VALVE TYPE	PRESSURE	FLOW PER SECTION
98600-B-433E(C)-1	3	2-Way	215 PSI (15 bar)	11.7 GPM (5 PSI Pressure Drop) 44 l/min (0.34 bar Pressure Drop)
98601-B-434E(C)-3FB	4	Flow Back	215 PSI (15 bar)	9.2 GPM (5 PSI Pressure Drop) 35 l/min (0.34 bar Pressure Drop)
98602-B-435E(C)-3	5	3-Way	215 PSI (15 bar)	11.7 GPM (5 PSI Pressure Drop) 44 l/min (0.34 bar Pressure Drop)

Note: Valves can be ordered in 1-9 sections configuration. For inlet and outlet connections refer to page 116.



Includes:

- Section valves in 2-way, Flow Back, or 3-way style.
- Pressure relief valve (98510-PP).

MODEL NUMBER	VALVE SECTIONS	VALVE TYPE	PRESSURE	FLOW PER SECTION
98600-A-437E(C)-2	7	2-Way	215 PSI (15 bar)	11.7 GPM (5 PSI Pressure Drop) 44 l/min (0.34 bar Pressure Drop)
98601-A-435E(C)-3FB	5	Flow Back	215 PSI (15 bar)	9.2 GPM (5 PSI Pressure Drop) 35 l/min (0.34 bar Pressure Drop)
98602-A-433E(C)-3	3	3-Way	215 PSI (15 bar)	11.7 GPM (5 PSI Pressure Drop) 44 l/min (0.34 bar Pressure Drop)

Note: Valves can be ordered in 1-9 sections configuration. For inlet and outlet connections refer to page 116.

Individual 430 Manifold Accessories



344BRL-TH Throttling Regulating Valve



98510 Pressure Relief Valve



801A Flow Meter



344BRL-B Bypass Regulating Valve



AA126ML-M50 Line Strainer



AA122ML-QC Outlet Strainer

Not shown: 346BE(C)-2M 2-Way Master Shutoff Valve
AB98499-KIT 4-Bolt Flange Accessory Mounting Kit



DirectoValve® 440 Series Manifold Shutoff Valves

The TeeJet® 440BEC series DirectoValve manifold provides a convenient, compact solution for the installation of multiple 344BEC electric ball valves. This system eliminates the need for custom fabrication of pipe or hose manifolds, drastically reducing both installation time and the chance for fluid leaks.

440BEC shutoff ball valves are available with E or EC series motors with cable or DIN electrical connections. See page 78 for more information on DirectoValve motors.

Features:

- Based on proven design of 344 ball valves.
22 RPM, 0.7 second shutoff fully open to close.
- Quick, simple plumbing of up to five electric ball valves.
- Flexible inlet and outlet connection options.
- Easy mounting with built-in brackets.
- Maximum pressure rating of 300 PSI (20 bar).
- Flow rate 26 GPM (98 l/min) with 5 PSI (0.34 bar) pressure drop, 37 GPM (140 l/min) with 10 PSI (0.69 bar) pressure drop (flow rate may vary based on number of valves and inlet size).
- Incorporates an internal resettable fuse.
- 12 VDC operation.
- Stainless steel stem with optional polypropylene or stainless steel ball.



441BEC-4T4T-C Valve
(rear view)



443BEC-4T4T-C Valve
(rear view)

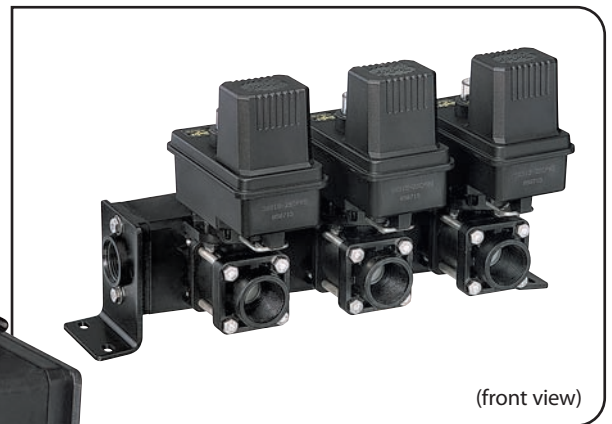

(front view)



Sample Valve Part Number:

(B)443BEC-4S4H4T-CN15AB

OUTLET THREADS

PART CODE	DESCRIPTION
BLANK	ALL THREADS TO BE NPT (IF EQUIPPED)
(B)	ALL THREADS TO BE BSPT (IF EQUIPPED)

440 MANIFOLD SIZES

PART CODE	DESCRIPTION
0	SINGLE REPLACEMENT VALVE
1	1-VALVE MANIFOLD
2	2-VALVE MANIFOLD
3	3-VALVE MANIFOLD
4	4-VALVE MANIFOLD
5	5-VALVE MANIFOLD

MOTOR SPECIFICATIONS

PART CODE	SWITCH	DESCRIPTION
E	DPDT	22 RPM, 0.7 SECOND SHUTOFF VALVE
EC	SPST	

END CAPS OR OUTLET FITTINGS

PART CODE	DESCRIPTION
3	3/4" PIPE THREAD
4	1" PIPE THREAD
Q	QUICK CONNECT
F	50 SERIES FLANGE

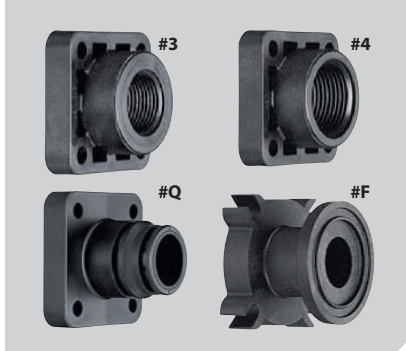

BALL MATERIAL SPECIFICATIONS

PART CODE	DESCRIPTION
BLANK	POLYPROPYLENE BALL
S	STAINLESS STEEL BALL

LEFT/RIGHT SIDE INLET FITTINGS

PART CODE	DESCRIPTION
4T	1" PIPE THREAD
4H	1" HOSE BARB
5H	1 1/4" HOSE BARB
B	INLET BLANK
1T	1/4" THREAD GAUGE PORT

Note: Right and left sides are as seen with outlets facing towards you (front view).

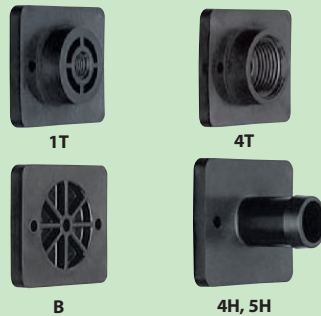

WIRING CONNECTORS

SPECIFY ELECTRICAL CONNECTOR STYLE AND PIN-OUTS. IF NO CONNECTOR IS NEEDED LEAVE BLANK.

See page 117 for electrical connectors and codes.

MOTOR CABLES

PART CODE	DESCRIPTION
C	POSITIVELY SWITCHED w/ 0.5-METER CABLE
CN	NEGATIVELY SWITCHED w/ 0.5-METER CABLE
* C03	POSITIVELY SWITCHED w/ 0.3-METER CABLE
* CN03	NEGATIVELY SWITCHED w/ 0.3-METER CABLE
* C15	POSITIVELY SWITCHED w/ 1.5-METER CABLE
* CN15	NEGATIVELY SWITCHED w/ 1.5-METER CABLE
* C60	POSITIVELY SWITCHED w/ 6.0-METER CABLE
* CN60	NEGATIVELY SWITCHED w/ 6.0-METER CABLE
D	POSITIVELY SWITCHED w/ DIN CONNECTOR
DN	NEGATIVELY SWITCHED w/ DIN CONNECTOR

Items marked with "*" are non-stock items. Please contact your regional sales office for ordering and availability information.

Note: DIN cables must be ordered separately. See page 78 for DIN cables.

REPAIR KIT

AB344AE-KIT

INLET/OUTLET REQUIRED CONNECTIONS

- **3, 4:** When ordering a standard 440 series manifold, inlets/outlets will be completed in the ordering process. No additional valve connections are required.
- **F:** When ordering F (flange) type valve outlet connections, only the outlets will be 50 series flange fittings and are ordered separately. One 50 series clamp and flange fitting is required for each valve in the manifold. See pages 114–115 for flange fitting options. The inlets will be standard 440 connections as described in the ordering process.
- **Q:** When ordering QC (Quick Connect) type valve outlet fittings, only the outlets will be QC fittings and are ordered separately. One 45229 QC hose barb connection is required for each valve in the manifold. See page 116 for QC hose barb options. The inlets will be standard 440 connections as described in the ordering process.

Note: Other valve configurations are possible by mixing and matching flange fittings.



DirectoValve® 450 Series Shutoff Manifold

450BEC manifolds are available with E or EC series motors with cable or DIN electrical connections. See page 78 for more information on DirectoValve motors.

Features:

- 22 RPM, 0.7 second shutoff fully open to close.
- Available in 2-way and Flow Back versions. Pressure regulating valves can be incorporated.
- Flexible inlet/outlet connections allow for quick, simple plumbing for as many valves as needed for your sprayer.
- Stainless steel stem with optional polypropylene or stainless steel ball.
- Maximum pressure rating of 200 PSI (14 bar).
- The flow rate for the 450BEC 2-way valve is 32 GPM (121 l/min) with 5 PSI (0.34 bar) pressure drop, 45 GPM (170 l/min) with 10 PSI (0.69 bar) pressure drop.
- Wetted parts are Nylon, Teflon®, polypropylene and Viton®.



451BEC-2F-C Valve
(rear view)



(front view)



453BEC-24-C Manifold
(rear view)

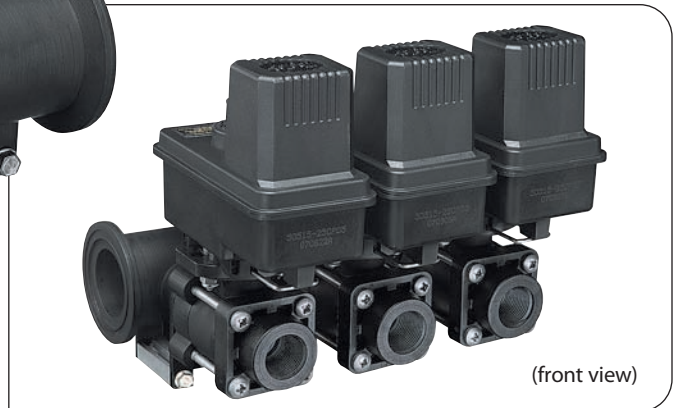

(front view)



Sample Valve Part Number:

(B)453BEC-2FS-CN15AB

OUTLET THREADS

PART CODE	DESCRIPTION
BLANK	ALL THREADS TO BE NPT (IF EQUIPPED)
(B)	ALL THREADS TO BE BSPT (IF EQUIPPED)

MODEL SPECIFICATION

PART CODE	DESCRIPTION
45	450 MANIFOLD

MANIFOLD SIZES

PART CODE	DESCRIPTION
1	1-VALVE MANIFOLD
2	2-VALVE MANIFOLD
3	3-VALVE MANIFOLD
4	4-VALVE MANIFOLD
5	5-VALVE MANIFOLD

MOTOR SPECIFICATIONS

PART CODE	SWITCH	DESCRIPTION
E	DPDT	22 RPM, 0.7 SECOND SHUTOFF VALVE
EC	SPST	

VALVE TYPE

PART CODE	DESCRIPTION
2	2-WAY VALVE
2N	2-WAY VALVE, NARROW

Note: 3-way valve type not available on 450 manifold.

END CAPS OR OUTLET FITTINGS

PART CODE	DESCRIPTION
3	3/4" PIPE THREAD
4	1" PIPE THREAD
Q	QUICK CONNECT
F	50 SERIES FLANGE

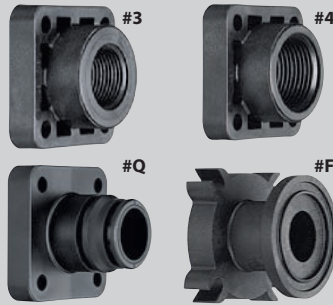

WIRING CONNECTORS

SPECIFY ELECTRICAL CONNECTOR STYLE AND PIN-OUTS. IF NO CONNECTOR IS NEEDED LEAVE BLANK.

See page 117 for electrical connectors and codes.

MOTOR CABLES

PART CODE	DESCRIPTION
C	POSITIVELY SWITCHED w/ 0.5-METER CABLE
CN	NEGATIVELY SWITCHED w/ 0.5-METER CABLE
* C03	POSITIVELY SWITCHED w/ 0.3-METER CABLE
* CN03	NEGATIVELY SWITCHED w/ 0.3-METER CABLE
* C15	POSITIVELY SWITCHED w/ 1.5-METER CABLE
* CN15	NEGATIVELY SWITCHED w/ 1.5-METER CABLE
* C60	POSITIVELY SWITCHED w/ 6.0-METER CABLE
* CN60	NEGATIVELY SWITCHED w/ 6.0-METER CABLE
D	POSITIVELY SWITCHED w/ DIN CONNECTOR
DN	NEGATIVELY SWITCHED w/ DIN CONNECTOR

Items marked with "*" are non-stock items. Please contact your regional sales office for ordering and availability information.

Note: DIN cables must be ordered separately. See page 78 for DIN cables.

INLET/OUTLET REQUIRED CONNECTIONS

THE INLET/OUTLET FITTINGS ARE ORDERED SEPARATELY

- **3, 4:** When ordering 3/4" (3) or 1" (4) NPT or BSPT threaded connections, the valve outlet connection will be completed during the ordering process. For the inlets, the 75 series flange fittings are ordered separately. Two 75 series clamps and fittings are required per manifold assembly. See pages 114–115 for flange fitting options.
- **F:** When ordering F (flange) type valve connections, the inlet/outlet fittings are ordered separately. For the outlet, one 50 series clamp and flange fitting is required per valve. For the inlets, two 75 series clamps and flange fittings are required per manifold assembly. See pages 114–115 for flange fitting options.
- **Q:** When ordering QC (Quick Connect) type valve outlet fittings, only the outlets will be QC fittings and are ordered separately. One 45229 QC hose barb connection is required for each valve in the manifold. See page 116 for QC hose barb options. The inlets will be standard 440 connections as described in the ordering process.

Note: Many manifold configurations are possible by mixing and matching flange fittings.

BALL MATERIAL SPECIFICATIONS

PART CODE	DESCRIPTION
BLANK	POLYPROPYLENE BALL
S	STAINLESS STEEL BALL

REPAIR KIT

AB344AE-KIT



DirectoValve® 450 Series Flow Back Manifold

The 450FB Flow Back valves allow pressure from the boom lines to be relieved back to the tank when the valve is switched to the off position.

Available with E or EC series motors with cable or DIN electrical connections. See page 78 for more information on DirectoValve motors.

Features:

- 22 RPM, 0.7 second shutoff fully open to close.
- With a choice of threaded, QC (Quick Connect) hose barbs or 50 series flange fitting outlet connections, the 450FB manifolds allow quick, simple plumbing for as many valves as needed for your sprayer.
- Choice of polypropylene or stainless steel ball with stainless steel stem.
- Flow rate is 32 GPM (120 l/min) with 5 PSI (0.34 bar) pressure drop per valve, 45 GPM (170 l/min) with 10 PSI (0.69 bar) pressure drop.
- Maximum pressure rating of 200 PSI (14 bar).
- The 450 valve series is also available in 2-way versions, see page 100 for further information.



**453BEC-3FB4-C
Manifold**
(rear view)

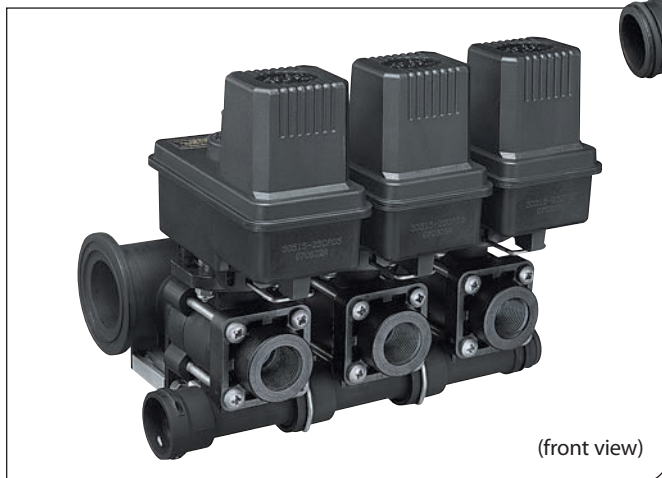

(front view)



Sample Valve Part Number:

(B)453BEC-3FBFS-CN15AB

OUTLET THREADS	
PART CODE	DESCRIPTION
BLANK	ALL THREADS TO BE NPT (IF EQUIPPED)
(B)	ALL THREADS TO BE BSPT (IF EQUIPPED)

MODEL SPECIFICATION	
PART CODE	DESCRIPTION
45	450 MANIFOLD

MANIFOLD SIZES	
PART CODE	DESCRIPTION
1	1-VALVE MANIFOLD
2	2-VALVE MANIFOLD
3	3-VALVE MANIFOLD
4	4-VALVE MANIFOLD
5	5-VALVE MANIFOLD

MOTOR SPECIFICATIONS		
PART CODE	SWITCH	DESCRIPTION
E	DPDT	22 RPM, 0.7 SECOND SHUTOFF VALVE
EC	SPST	

VALVE TYPE	
PART CODE	DESCRIPTION
3FB	FLOW BACK

END CAPS OR OUTLET FITTINGS	
PART CODE	DESCRIPTION
3	3/4" PIPE THREAD
4	1" PIPE THREAD
Q	QUICK CONNECT
F	50 SERIES FLANGE

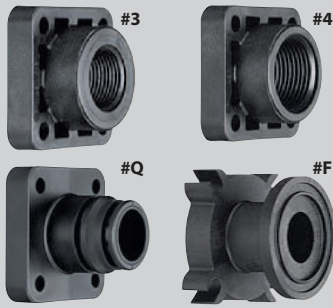

WIRING CONNECTORS
SPECIFY ELECTRICAL CONNECTOR STYLE AND PIN-OUTS. IF NO CONNECTOR IS NEEDED LEAVE BLANK.
See page 117 for electrical connectors and codes.

MOTOR CABLES	
PART CODE	DESCRIPTION
C	POSITIVELY SWITCHED w/ 0.5-METER CABLE
CN	NEGATIVELY SWITCHED w/ 0.5-METER CABLE
* C03	POSITIVELY SWITCHED w/ 0.3-METER CABLE
* CN03	NEGATIVELY SWITCHED w/ 0.3-METER CABLE
* C15	POSITIVELY SWITCHED w/ 1.5-METER CABLE
* CN15	NEGATIVELY SWITCHED w/ 1.5-METER CABLE
* C60	POSITIVELY SWITCHED w/ 6.0-METER CABLE
* CN60	NEGATIVELY SWITCHED w/ 6.0-METER CABLE
D	POSITIVELY SWITCHED w/ DIN CONNECTOR
DN	NEGATIVELY SWITCHED w/ DIN CONNECTOR

INLET/OUTLET REQUIRED CONNECTIONS
THE INLET/OUTLET FITTINGS ARE ORDERED SEPARATELY

- **3, 4:** When ordering 3/4" (3) or 1" (4) NPT or BSPT threaded connections, the valve outlet connection will be completed during the ordering process.
 - For the inlets, two 75 series flange fittings and two 75 series clamps are required. For the Flow Back ports, two 45529 Quick Connect fittings are required.*
 - **F:** For the flange fitting versions, one 50 series single clamp and 50 series flange fitting is required per valve outlet.
 - For the inlets, two 75 series flange fittings and two 75 series clamps are required. For the Flow Back ports, two 45529 Quick Connect fittings are required.*
 - **Q:** For Quick Connect versions, one 45529 QC hose barb fitting is required per valve outlet.
 - For the inlets, two 75 series flange fittings and two 75 series clamps are required. For the Flow Back ports, two 45529 Quick Connect fittings are required.*
- *See pages 114–116 for flange and Quick Connect fitting options.
Note: Many manifold configurations are possible by mixing and matching flange fittings.

Items marked with "*" are non-stock items. Please contact your regional sales office for ordering and availability information.
Note: DIN cables must be ordered separately. See page 78 for DIN cables.

BALL MATERIAL SPECIFICATIONS	
PART CODE	DESCRIPTION
BLANK	POLYPROPYLENE BALL
S	STAINLESS STEEL BALL

REPAIR KIT
AB344AE-KIT



DirectoValve® 460 Series 2-Way Manifold

The 460BEC ball valve manifold utilizes a compact design that provides reliable performance at a wide range of operating pressures. Available with E or EC series motors with cable or DIN electrical connections. See page 78 for more information on DirectoValve motors.

Features:

- 22 RPM, 0.7 second shutoff fully open to close.
- With a choice of threaded, QC (Quick Connect) hose barbs or 50 series flange fitting outlet connections, the 460BEC manifold allows quick, simple plumbing for as many valves as needed for your sprayer.
- Stainless steel stem and ball.
- Flow rate: 25 GPM (94 l/min) at 5 PSI (0.34 bar) pressure drop, 35 GPM (132 l/min) at 10 PSI (0.69 bar) pressure drop.
- Maximum pressure rating of 300 PSI (20 bar).
- The 460BEC valve series is also available in 3-way and Flow Back versions. See page 106 for 460B 3C and 3E, 3-way versions and page 108 for 460FB Flow Back version.



461BEC-2F-C Valve
(front view)

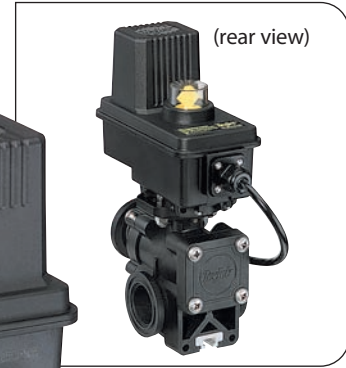

(rear view)



463BEC-2F-C Manifold
(rear view)

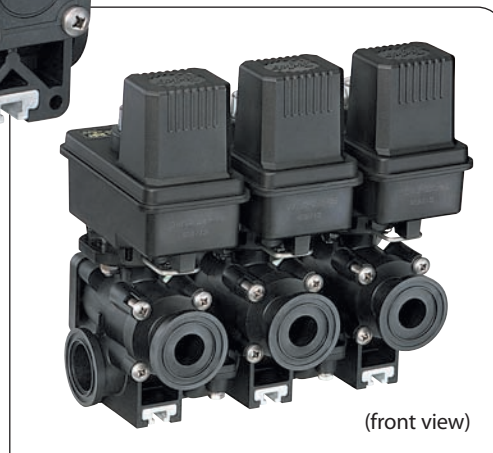

(front view)



Sample Valve Part Number:

(B)463BEC-2F-CN15AB

OUTLET THREADS	
PART CODE	DESCRIPTION
BLANK	ALL THREADS TO BE NPT (IF EQUIPPED)
(B)	ALL THREADS TO BE BSPT (IF EQUIPPED)

MODEL SPECIFICATION	
PART CODE	DESCRIPTION
46	460 MANIFOLD

MANIFOLD SIZES	
PART CODE	DESCRIPTION
1	1-VALVE MANIFOLD
2	2-VALVE MANIFOLD
3	3-VALVE MANIFOLD
4	4-VALVE MANIFOLD
5	5-VALVE MANIFOLD

MOTOR SPECIFICATIONS		
PART CODE	SWITCH	DESCRIPTION
E	DPDT	22 RPM, 0.7 SECOND SHUTOFF VALVE
EC	SPST	

VALVE TYPE	
PART CODE	DESCRIPTION
2	2-WAY VALVE

See page 107 for 3-way valve.

END CAPS OR OUTLET FITTINGS	
PART CODE	DESCRIPTION
3	3/4" PIPE THREAD
4	1" PIPE THREAD
Q	QUICK CONNECT
F	50 SERIES FLANGE

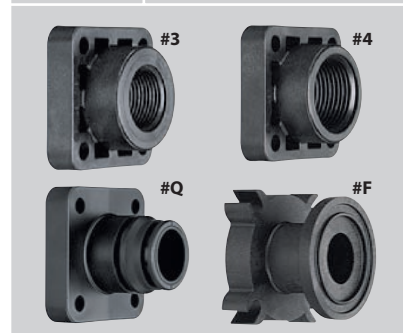

WIRING CONNECTORS
SPECIFY ELECTRICAL CONNECTOR STYLE AND PIN-OUTS. IF NO CONNECTOR IS NEEDED LEAVE BLANK.
See page 117 for electrical connectors and codes.

MOTOR CABLES	
PART CODE	DESCRIPTION
C	POSITIVELY SWITCHED w/ 0.5-METER CABLE
CN	NEGATIVELY SWITCHED w/ 0.5-METER CABLE
* C03	POSITIVELY SWITCHED w/ 0.3-METER CABLE
* CN03	NEGATIVELY SWITCHED w/ 0.3-METER CABLE
* C15	POSITIVELY SWITCHED w/ 1.5-METER CABLE
* CN15	NEGATIVELY SWITCHED w/ 1.5-METER CABLE
* C60	POSITIVELY SWITCHED w/ 6.0-METER CABLE
* CN60	NEGATIVELY SWITCHED w/ 6.0-METER CABLE
D	POSITIVELY SWITCHED w/ DIN CONNECTOR
DN	NEGATIVELY SWITCHED w/ DIN CONNECTOR

Items marked with "*" are non-stock items. Please contact your regional sales office for ordering and availability information.

Note: DIN cables must be ordered separately. See page 78 for DIN cables.

INLET/OUTLET REQUIRED CONNECTIONS THE INLET/OUTLET FITTINGS ARE ORDERED SEPARATELY

- **3, 4:** When ordering 3/4" (3) or 1" (4) NPT or BSPT threaded connections, the valve outlet connection will be completed during the ordering process. For the inlets to be threaded, the 50 series flange fittings are ordered separately. Two 50 series single clamps and fittings are required per manifold assembly. See pages 114–115 for flange fitting options.
- **F:** For the flange fitting versions, one 50 series single clamp and flange fitting is required per valve. For the inlets, two 50 series single clamps and flange fittings are required per manifold assembly. See pages 114–115 for flange fitting options.
- **Q:** When ordering QC (Quick Connect) hose barb type valve fittings. For the outlet, one 45529 QC hose barb connection is required per valve. 460 inlets are 50 series standard flanges. Any two 50 series fittings and clamps may be ordered. For the inlets to be QC, requires two each, CP46029-PP QC flange adapters, 50 series single clamps and 45529 QC hose barb connections per manifold assembly. See page 116 for QC fitting options.

Note: Many manifold configurations are possible by mixing and matching flange fittings.

REPAIR KIT
AB460-KIT



DirectoValve® 460 Series 3-Way Manifold

The 460BEC 3-way ball valve manifold features an adjustable bypass setting that maintains a constant system pressure regardless of the valve being in the ON or OFF position. This is particularly effective on sprayers equipped with positive displacement pumps. Available with E or EC series motors with cable or DIN electrical connections. See page 78 for more information on DirectoValve motors.

Features:

- 22 RPM, 0.7 second shutoff fully open to close.
- Version C has VisiFlo® color-coded settings that can be used to match multiple tips.
- Version E has a single adjustment.
- With a choice of threaded, QC (Quick Connect) hose barbs or 50 series flange fitting outlet connections, the 460BEC manifold allows quick, simple plumbing for as many valves as needed for your sprayer.
- Stainless steel stem and ball.
- Flow rate: 25 GPM (94 l/min) at 5 PSI (0.34 bar) pressure drop, 35 GPM (132 l/min) at 10 PSI (0.69 bar) pressure drop.
- Maximum pressure rating of 300 PSI (20 bar).
- The 460BEC valve series is also available in 2-way and Flow Back versions. See page 104 for 460BEC 2-way version and page 108 for 460FB Flow Back version.

461BEC-3EF-C Valve
(rear view)



461BEC-3CF-C Valve
(rear view)



463BEC-3CF-C Manifold
(rear view)



463BEC-3EF-C Manifold
(rear view)

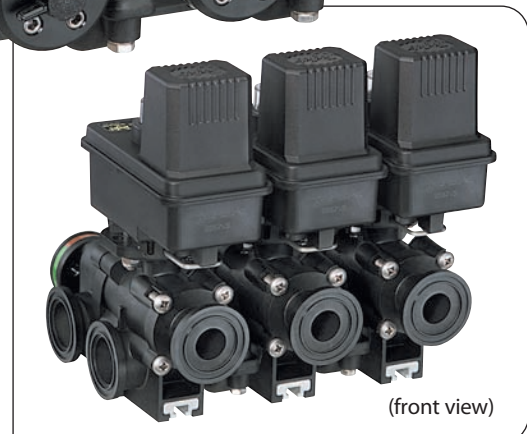

(front view)



Sample Valve Part Number:

(B)463BEC-3CF-CN15AB

OUTLET THREADS	
PART CODE	DESCRIPTION
BLANK	ALL THREADS TO BE NPT (IF EQUIPPED)
(B)	ALL THREADS TO BE BSPT (IF EQUIPPED)

MODEL SPECIFICATION	
PART CODE	DESCRIPTION
46	460 MANIFOLD

MANIFOLD SIZES	
PART CODE	DESCRIPTION
1	1-VALVE MANIFOLD
2	2-VALVE MANIFOLD
3	3-VALVE MANIFOLD
4	4-VALVE MANIFOLD
5	5-VALVE MANIFOLD

MOTOR SPECIFICATIONS		
PART CODE	SWITCH	DESCRIPTION
E	DPDT	22 RPM, 0.7 SECOND SHUTOFF VALVE
EC	SPST	

VALVE TYPE	
PART CODE	DESCRIPTION
3C	3-WAY VALVE
3E	

See page 105 for 2-way valve.

END CAPS OR OUTLET FITTINGS	
PART CODE	DESCRIPTION
3	3/4" PIPE THREAD
4	1" PIPE THREAD
Q	QUICK CONNECT
F	50 SERIES FLANGE

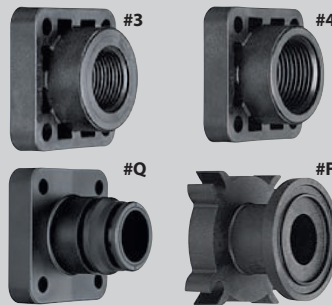

WIRING CONNECTORS
SPECIFY ELECTRICAL CONNECTOR STYLE AND PIN-OUTS. IF NO CONNECTOR IS NEEDED LEAVE BLANK.
See page 117 for electrical connectors and codes.

MOTOR CABLES	
PART CODE	DESCRIPTION
C	POSITIVELY SWITCHED w/ 0.5-METER CABLE
CN	NEGATIVELY SWITCHED w/ 0.5-METER CABLE
* C03	POSITIVELY SWITCHED w/ 0.3-METER CABLE
* CN03	NEGATIVELY SWITCHED w/ 0.3-METER CABLE
* C15	POSITIVELY SWITCHED w/ 1.5-METER CABLE
* CN15	NEGATIVELY SWITCHED w/ 1.5-METER CABLE
* C60	POSITIVELY SWITCHED w/ 6.0-METER CABLE
* CN60	NEGATIVELY SWITCHED w/ 6.0-METER CABLE
D	POSITIVELY SWITCHED w/ DIN CONNECTOR
DN	NEGATIVELY SWITCHED w/ DIN CONNECTOR

INLET/OUTLET REQUIRED CONNECTIONS THE INLET/OUTLET FITTINGS ARE ORDERED SEPARATELY

- **3, 4:** When ordering 3/4" (3) or 1" (4) NPT or BSPT threaded connections, the valve outlet connection will be completed during the ordering process. For the inlets to be threaded, the 50 series flange fittings are ordered separately. Two 50 series double clamps and four flange fittings are required per manifold assembly. See pages 114–115 for flange fitting options.
- **F:** For the flange fitting versions, one 50 series single clamp and flange fitting is required per valve. For the inlets, two 50 series double clamps and four flange fittings are required per manifold assembly. See pages 114–115 for flange fitting options.
- **Q:** When ordering QC (Quick Connect) hose barb type valve fittings. For the outlet, one 45529 QC hose barb connection is required per valve. 460 inlets are 50 series standard flanges. Any four 50 series fittings and two double clamps may be ordered. For the inlets to be QC, requires four each, CP46029-PP QC flange adapters, 45529 QC hose barb connections and two 50 series clamps per manifold assembly. See pages 114–116 for QC and flange options.

Note: Many manifold configurations are possible by mixing and matching flange fittings.

Items marked with "*" are non-stock items. Please contact your regional sales office for ordering and availability information.

Note: DIN cables must be ordered separately. See page 78 for DIN cables.

REPAIR KIT
AB460-KIT



DirectoValve® 460 Series Flow Back Manifold

The 460FB Flow Back valves allow pressure from the boom lines to be relieved back to the tank when the valve is switched to the off position.

Available with E or EC series motors with cable or DIN electrical connections. See page 78 for more information on DirectoValve motors.

Features:

- 22 RPM, 0.7 second shutoff fully open to close.
- With a choice of threaded, QC (Quick Connect) hose barbs or 50 series flange fitting outlet connections, the 460FB manifolds allow quick, simple plumbing for as many valves as needed for your sprayer.
- Stainless steel stem and ball.
- Flow rate is 24 GPM (91 l/min) with 5 PSI (0.34 bar) pressure drop, 34 GPM (129 l/min) with 10 PSI (0.69 bar) pressure drop.
- Maximum pressure rating of 115 PSI (8 bar).
- The 460FB valve series are also available in 2-way and 3-way versions, see pages 104 and 106.



461BEC-3FB4-C Valve
(rear view)



(front view)





Sample Valve Part Number:

(B) 463BEC-3FBF-CN15AB

OUTLET THREADS	
PART CODE	DESCRIPTION
BLANK	ALL THREADS TO BE NPT (IF EQUIPPED)
(B)	ALL THREADS TO BE BSPT (IF EQUIPPED)

MODEL SPECIFICATION	
PART CODE	DESCRIPTION
46	460 MANIFOLD

MANIFOLD SIZES	
PART CODE	DESCRIPTION
1	1-VALVE MANIFOLD
2	2-VALVE MANIFOLD
3	3-VALVE MANIFOLD
4	4-VALVE MANIFOLD
5	5-VALVE MANIFOLD

MOTOR SPECIFICATIONS		
PART CODE	SWITCH	DESCRIPTION
E	DPDT	22 RPM, 0.7 SECOND SHUTOFF VALVE
EC	SPST	

VALVE TYPE	
PART CODE	DESCRIPTION
3FB	FLOW BACK

See page 107 for 3-way valve.

END CAPS OR OUTLET FITTINGS	
PART CODE	DESCRIPTION
3	3/4" PIPE THREAD
4	1" PIPE THREAD
Q	QUICK CONNECT
F	50 SERIES FLANGE

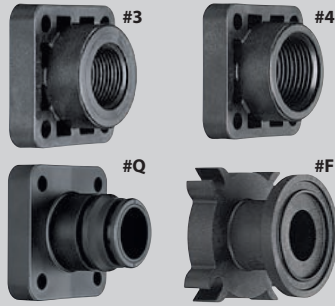

WIRING CONNECTORS	
SPECIFY ELECTRICAL CONNECTOR STYLE AND PIN-OUTS. IF NO CONNECTOR IS NEEDED LEAVE BLANK.	
See page 117 for electrical connectors and codes.	

MOTOR CABLES	
PART CODE	DESCRIPTION
C	POSITIVELY SWITCHED w/ 0.5-METER CABLE
CN	NEGATIVELY SWITCHED w/ 0.5-METER CABLE
* C03	POSITIVELY SWITCHED w/ 0.3-METER CABLE
* CN03	NEGATIVELY SWITCHED w/ 0.3-METER CABLE
* C15	POSITIVELY SWITCHED w/ 1.5-METER CABLE
* CN15	NEGATIVELY SWITCHED w/ 1.5-METER CABLE
* C60	POSITIVELY SWITCHED w/ 6.0-METER CABLE
* CN60	NEGATIVELY SWITCHED w/ 6.0-METER CABLE
D	POSITIVELY SWITCHED w/ DIN CONNECTOR
DN	NEGATIVELY SWITCHED w/ DIN CONNECTOR

Items marked with "*" are non-stock items. Please contact your regional sales office for ordering and availability information.

Note: DIN cables must be ordered separately. See page 78 for DIN cables.

INLET/OUTLET REQUIRED CONNECTIONS THE INLET/OUTLET FITTINGS ARE ORDERED SEPARATELY

- **3, 4:** When ordering 3/4" (3) or 1" (4) NPT or BSPT threaded connections, the valve outlet connection will be completed during the ordering process.
 - For inlets and Flow Back ports, four 50 series flange fittings and two 50 series double clamps are required per manifold.*
 - **F:** For the flange fitting versions, one 50 series single clamp and 50 series flange fitting is required per valve outlet.
 - For inlets and Flow Back ports, four 50 series flange fittings and two 50 series double clamps are required per manifold.*
 - **Q:** For Quick Connect versions, one 45529 QC hose barb fitting is required per valve outlet.
 - For inlets and Flow Back ports, four 50 series flange fittings and two 50 series double clamps are required per manifold.*
- *See pages 114–116 for flange and Quick Connect fitting options.
Note: Many manifold configurations are possible by mixing and matching flange fittings.

REPAIR KIT
AB460-KIT



DirectoValve® 490 Series Shutoff Manifold

The 490BEC DirectoValve control valve delivers performance and dependability. The trunnion-style valve is a hard-working, commercial-duty control valve made to go the distance. It combines dozens of design features into a valve that will respond quickly and last longer than other valves.

Available with E or EC series motors with cable or DIN electrical connections.

Features:

- 25 RPM, 0.6 second shutoff fully open to close. See page 78 for more information about DirectoValve motors.
- Flexible 50 series flange fitting inlet/outlet connections allow quick, simple plumbing for as many valves as needed for your sprayer.
- Available in 2-way version only. Pressure regulating valves can be incorporated.
- A uniquely designed 316 stainless steel ball reduces the amount of material that can be trapped in the valve. This reduces the likelihood of ball corrosion, reduces seal wear and increases the overall life of the valve.
- Flow rate: 100 GPM (379 l/min) at 5 PSI (0.34 bar) pressure drop, 141 GPM (534 l/min) at 10 PSI (0.69 bar) pressure drop.
- Maximum pressure rating of 150 PSI (10 bar).
- Wetted parts are polypropylene, stainless steel, carbon-filled Teflon®, Viton® and Ryton®.
- Wear-resistant carbon-filled Teflon seals improve durability and minimize the potential for leaks.
- Fasteners and mounting foot made of stainless steel to prevent corrosion, provide strength and provide easy mounting using a $\frac{3}{16}$ " or 8 mm bolt.

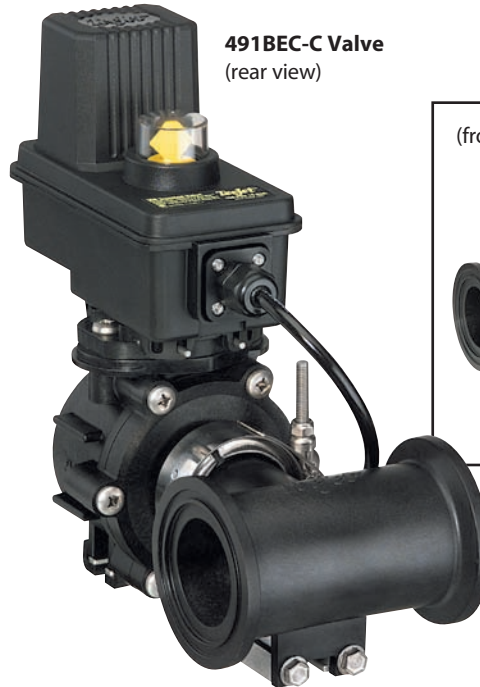

491BEC-C Valve
(rear view)



(front view)

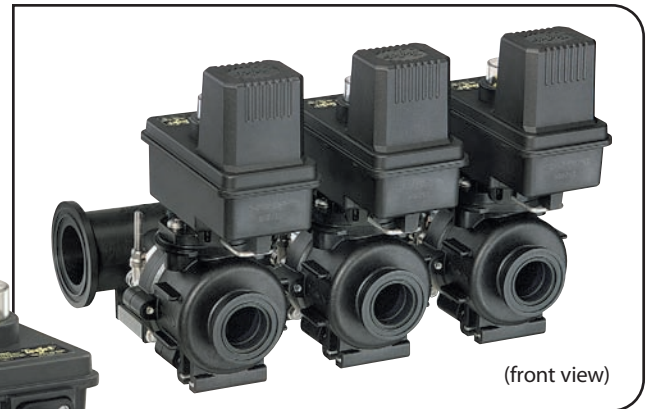

(front view)

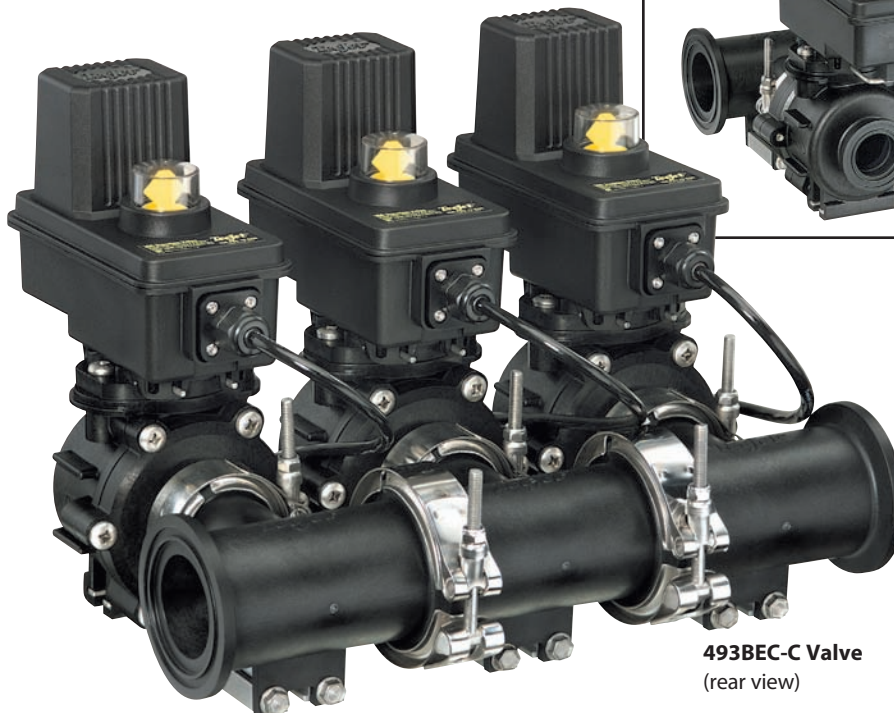

493BEC-C Valve
(rear view)



Sample Valve Part Number:

493BEC-CN15AB

MODEL SPECIFICATION	
PART CODE	DESCRIPTION
49	490 MANIFOLD

MANIFOLD SIZES	
PART CODE	DESCRIPTION
1	1-VALVE MANIFOLD
2	2-VALVE MANIFOLD
3	3-VALVE MANIFOLD
4	4-VALVE MANIFOLD
5	5-VALVE MANIFOLD



INLET/OUTLET REQUIRED CONNECTIONS
THE INLET/OUTLET FITTINGS ARE ORDERED SEPARATELY

- **F:** For the outlets, one 50 series clamp and fitting is required per valve. For the inlets, two 75 series clamps and flange fittings are required. See pages 114–115 for flange fitting options.
 - **Q:** Quick Connect) hose barb type valve fittings are not normally used due to flow limitations. See page 116 for more information on QC fittings.
- Note:** Many manifold configurations are possible by mixing and matching flange fittings.

MOTOR CABLES	
PART CODE	DESCRIPTION
C	POSITIVELY SWITCHED w/ 0.5-METER CABLE
CN	NEGATIVELY SWITCHED w/ 0.5-METER CABLE
* C03	POSITIVELY SWITCHED w/ 0.3-METER CABLE
* CN03	NEGATIVELY SWITCHED w/ 0.3-METER CABLE
* C15	POSITIVELY SWITCHED w/ 1.5-METER CABLE
* CN15	NEGATIVELY SWITCHED w/ 1.5-METER CABLE
* C60	POSITIVELY SWITCHED w/ 6.0-METER CABLE
* CN60	NEGATIVELY SWITCHED w/ 6.0-METER CABLE
D	POSITIVELY SWITCHED w/ DIN CONNECTOR
DN	NEGATIVELY SWITCHED w/ DIN CONNECTOR

Items marked with "*" are non-stock items. Please contact your regional sales office for ordering and availability information.
Note: DIN cables must be ordered separately. See page 78 for DIN cables.

WIRING CONNECTORS

SPECIFY ELECTRICAL CONNECTOR STYLE AND PIN-OUTS. IF NO CONNECTOR IS NEEDED LEAVE BLANK.

See page 117 for electrical connectors and codes.

MOTOR SPECIFICATIONS		
PART CODE	SWITCH	DESCRIPTION
E	DPDT	25 RPM, 0.6 SECOND SHUTOFF VALVE
EC	SPST	

REPAIR KIT

AB356-KIT



DirectoValve® 540 Series Shutoff Manifold

The 540EC control valve builds upon the proven reliability of TeeJet electric valves in an exciting new package. The gear driven, plunger-style design provides exceptional closing force for positive shutoff and sealing. When working with abrasive solutions, the plunger and seat can also provide improved wear-life as compared to other valve designs. Additionally, the side inlet and bottom outlet configuration provides for a clean and compact installation.

Features:

- Plunger valve design for positive and reliable shutoff.
- 0.7 second shutoff time fully open to fully closed.
- Available in 2-way version with side inlets and bottom outlet.
- 75 series flanged inlets allows for easy assembly of manifolds and accept a wide variety of flange fittings.
- Quick Connect outlet fitting for rapid attachment and removal of boom lines.
- Maximum pressure rating of 175 PSI (12 bar).
- Flow Rate: 27 GPM (102 l/min) at 5 PSI (0.34 bar) pressure drop, 38 GPM (144 l/min) at 10 PSI (0.69 bar) pressure drop.
- Wetted parts are polypropylene, nylon, stainless steel and Viton®.
- Integral mounting brackets allows for easy installation.
- Integrated 3-Pin Metri-Pack 150-series shroud connector allows for easy electrical hookup. Optional 98546 adapter cable available.



Wiring Chart

PIN	WIRE COLOR*	BEC MOTOR	BE MOTOR**
A	R	Constant +12VDC	+12VDC to open
B	W	Switched +12VDC (signal)	Not Used
C	B	Constant Ground	-12VDC to open

* Wire color used in optional 98546 cable.

** For BE motors reverse polarity to close. Requires DPDT switch.

Wire Codes:

- R** = Red
- W** = White
- B** = Black





Sample Valve Part Number:

543EC-2

MODEL SPECIFICATION	
PART CODE	DESCRIPTION
54	540 MANIFOLD

MOTOR SPECIFICATIONS		
PART CODE	SWITCH	DESCRIPTION
E	DPDT	0.7 SECOND SHUTOFF VALVE
EC	SPST	

MANIFOLD SIZES	
PART CODE	DESCRIPTION
1	1-VALVE MANIFOLD
2	2-VALVE MANIFOLD
3	3-VALVE MANIFOLD
4	4-VALVE MANIFOLD
5	5-VALVE MANIFOLD

VALVE TYPE	
PART CODE	DESCRIPTION
2	2-WAY VALVE

INLET/OUTLET REQUIRED CONNECTIONS

THE INLET/OUTLET FITTINGS ARE ORDERED SEPARATELY

- **F:** For the inlets, two 75 series clamps and flange fittings are required. See page 114–115 for flange fitting options.
- **Q:** For Quick Connect outlet, one 45529 QC hose barb is required per valve. See page 116 for Quick Connect fitting options.

Note: Many manifold configurations are possible by mixing and matching flange fittings.

REPAIR KIT

AB540-KIT

Sample Cable Part Number:

98546EC-15-VX

MODEL SPECIFICATION	
PART CODE	DESCRIPTION
98546EC	3-WIRE CABLE WITH METRI-PACK TOWER CONNECTION

LENGTH SPECIFICATION	
PART CODE	DESCRIPTION
05	0.5 METER (20")
15	1.5 METER (60")
30	3.0 METER (120")
60	6.0 METER (240")

WIRING CONNECTORS
SPECIFY ELECTRICAL CONNECTOR STYLE AND PIN-OUTS. IF NO CONNECTOR IS NEEDED LEAVE BLANK.
See page 117 for electrical connectors and codes.



DirectoValve® Flange Fittings

Features:

- Polypropylene construction.
- Full port design.
- Viton® O-ring seal available with clamp (not included with flange).

Straight Hose Barb Flanges

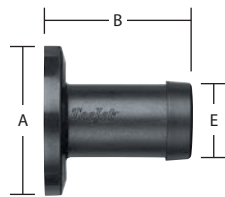

DESCRIPTION	SERIES	"A"	"B"	"E"	PART NUMBER
¾" Hose Barb	50	2" (51 mm)	1 1/16" (43 mm)	¾" (19 mm)	CP48150-PP
1" Hose Barb	50	2" (51 mm)	2" (51 mm)	1" (25 mm)	CP45504-PP
1 ¼" Hose Barb	50	2" (51 mm)	2" (51 mm)	1 ¼" (31 mm)	CP45505-PP
1 ½" Hose Barb	50	2" (51 mm)	2" (51 mm)	1 ½" (38 mm)	CP45506-PP
1 ¼" Hose Barb	75	3 1/16" (78 mm)	1 3/16" (46 mm)	1 ¼" (31 mm)	CP48160-PP
1 ½" Hose Barb	75	3 1/16" (78 mm)	2 3/16" (56 mm)	1 ½" (38 mm)	CP46067-PP
2" Hose Barb	75	3 1/16" (78 mm)	2 ¾" (70 mm)	2" (51 mm)	CP48161-PP

- Maximum pressure rating of 200 PSI (14 bar) for 75 series fittings.
- Maximum pressure rating of 300 PSI (20 bar) for 50 series fittings.

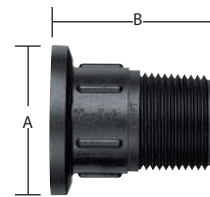

Threaded Flanges (Male)

DESCRIPTION	SERIES	"A"	"B"	PART NUMBER
¾" Male Pipe Thread	50	2" (51 mm)	2" (51 mm)	CP(B)48172-PP
1" Male Pipe Thread	50	2" (51 mm)	2 3/16" (56 mm)	CP(B)48155-PP
1 ½" Male Pipe Thread	50	2" (51 mm)	2 ¾" (70 mm)	CP(B)48156-PP
1 ¼" Male Pipe Thread	75	3 1/16" (78 mm)	2 ½" (64 mm)	CP(B)48165-PP
1 ½" Male Pipe Thread	75	3 1/16" (78 mm)	2 ½" (64 mm)	CP(B)48166-PP
2" Male Pipe Thread	75	3 1/16" (78 mm)	2 5/8" (65 mm)	CP(B)48167-PP

(B)=BSPT

90° Hose Barb Flanges



DESCRIPTION	SERIES	"A"	"B"	"C"	"E"	PART NUMBER
90° × ¾" Hose Barb	50	2" (51 mm)	1 ½" (38 mm)	2" (51 mm)	¾" (19 mm)	CP48151-PP
90° × 1" Hose Barb	50	2" (51 mm)	1 ½" (38 mm)	2" (51 mm)	1" (25 mm)	CP48152-PP
90° × 1 ¼" Hose Barb	50	2" (51 mm)	1 5/16" (49 mm)	2 5/16" (65 mm)	1 ¼" (31 mm)	CP72238-PP
90° × 1 ½" Hose Barb	50	2" (51 mm)	1 5/16" (49 mm)	2 5/16" (65 mm)	1 ½" (38 mm)	CP72239-PP
90° × 1 ¼" Hose Barb	75	3 1/16" (78 mm)	1 5/16" (49 mm)	2 5/16" (65 mm)	1 ¼" (31 mm)	CP48162-PP
90° × 1 ½" Hose Barb	75	3 1/16" (78 mm)	1 5/16" (49 mm)	2 5/16" (65 mm)	1 ½" (38 mm)	CP48163-PP
90° × 2" Hose Barb	75	3 1/16" (78 mm)	1 5/16" (49 mm)	3 5/16" (84 mm)	2" (51 mm)	CP48164-PP

Gauge Port Flange

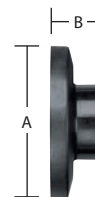

DESCRIPTION	SERIES	"A"	"B"	PART NUMBER
¼" Gauge Port	50	2" (51 mm)	¾" (19 mm)	CP(B)45508-1/4-PP CP(P)45508-1/4-PP
⅜" Gauge Port	50	2" (51 mm)	¾" (19 mm)	CP(B)45539-3/8-PP CP(P)45539-3/8-PP
Blank Inlet Cover	50	2" (51 mm)	5/16" (8 mm)	CP45507-PP
¼" Gauge Port	75	3 1/16" (78 mm)	¾" (9 mm)	CP(B)46127-1/4-PP
⅜" Gauge Port	75	3 1/16" (78 mm)	¾" (9 mm)	CP(B)46127-3/8-PP
Blank Inlet Cover	75	3 1/16" (78 mm)	¾" (9 mm)	CP46069-PP

(B)=BSPT (P)=BSPP

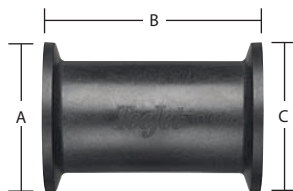

Straight Flange Couplings

DESCRIPTION	SERIES	"A"	"B"	"C"	PART NUMBER
Straight Coupling	50	2" (51 mm)	2 ¼" (57 mm)	2" (51 mm)	CP48157-PP
Straight Coupling	75	3 1/16" (78 mm)	4 3/8" (111 mm)	3 1/16" (78 mm)	CP48169-PP
Reducer Coupling	75/50	3 1/16" (78 mm)	2 3/16" (56 mm)	2" (51 mm)	CP45207-PP



90° Flange Couplings

DESCRIPTION	SERIES	"A"	"B"	"C"	PART NUMBER
90° Elbow Coupling	50	2" (51 mm)	2 3/16" (56 mm)	2 3/16" (56 mm)	CP48158-PP
90° Elbow Coupling	75	3 1/16" (78 mm)	2 3/16" (56 mm)	3 1/16" (79 mm)	CP48168-PP

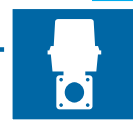

Threaded Flanges (Female)

DESCRIPTION	SERIES	"A"	"B"	PART NUMBER
1" Female Pipe Thread	50	2" (51 mm)	2" (51 mm)	CP(B)48154-PP
1¼" Female Pipe Thread	50	2" (51 mm)	2" (51 mm)	CP(B)45512-PP
1½" Female Pipe Thread	75	3½" (78 mm)	2" (51 mm)	CP(B)46066-PP

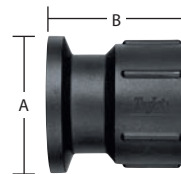

(B)=BSPT

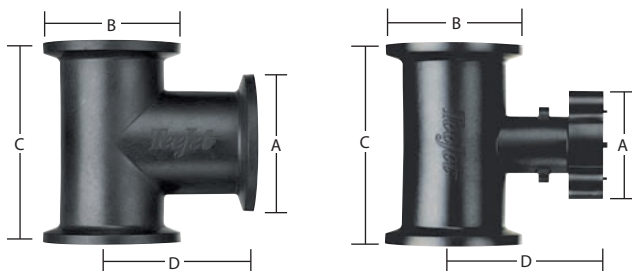

Tee Flanges

DESCRIPTION	SERIES	"A"	"B"	"C"	"D"	PART NUMBER
Tee	50	2" (51 mm)	2" (51 mm)	4¾" (111 mm)	27⁄8" (73 mm)	CP50193-PP
Narrow Tee		2" (51 mm)	2" (51 mm)	3¾" (81 mm)	2" (51 mm)	CP55242-PP
Reducer Tee	50/75	2" (51 mm)	3½" (78 mm)	4¾" (111 mm)	27⁄8" (73 mm)	CP46717-PP
Tee	75	3½" (78 mm)	3½" (78 mm)	4¾" (111 mm)	31⁄8" (79 mm)	CP46716-PP
450 Tee Body	75	—	3½" (78 mm)	4¾" (111 mm)	3¼" (82 mm)	CP45251-PP
450 Tee Body (Narrow)	75	—	3½" (78 mm)	31⁄8" (79 mm)	3¼" (82 mm)	CP55224-PP

Note: There are no mounting provisions on the 50 series tee.

48143 Mounting Kit

Mounts to underside of tee and includes one extrusion and four screws. Mounting kit is not included with tees. Must be ordered separately. Also requires 5⁄16" or 8 mm bolt.

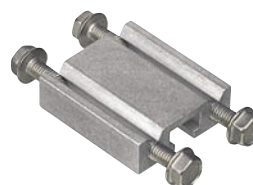

DESCRIPTION	PART NUMBER
Tee Mounting Kit (450 or 490 series manifold)	48143

Flange Clamps

DESCRIPTION	SERIES	PART NUMBER
2-Way Valve	50	46070*
3-Way Valve	50	46024*
2-Way Valve Stainless Steel	50	55245-50*
Viton® O-ring	50	CP7717-2/222-VI
2-Way Valve Stainless Steel	75	55245-75*
Viton O-ring	75	CP7717-2-229-VI



46024



46070



55245-50



55245-75

*Note: O-ring included.



DirectoValve® Quick Connect Fittings

- Standard Quick Connect fittings for use on valves and components equipped with Quick Connect outlets.
- Rated to 300 PSI (20 bar).

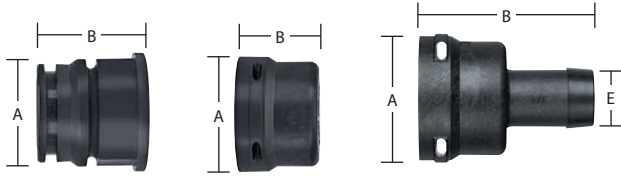

Quick Connect Straight Hose Barb

DESCRIPTION	SERIES	"A"	"B"	"E"	PART NUMBER
1/2" Straight Hose Barb	QC(f)	1 1/16" (43 mm)	2 1/4" (57 mm)	1/2" (12 mm)	45529-1/2
5/8" Straight Hose Barb				5/8" (15 mm)	45529-5/8
3/4" Straight Hose Barb				3/4" (19 mm)	45529-3/4
1" Straight Hose Barb				1" (25 mm)	45529-1
Quick Connect Cap	QC(m)	1 1/16" (43 mm)	1 1/8" (28 mm)		45529-C
Quick Connect Plug	QC(m)	1 7/16" (36 mm)	1 3/16" (33 mm)		45529-P

Note: O-ring and clip included.



90° Quick Connect Hose Barb

DESCRIPTION	SERIES	"A"	"B"	"C"	"E"	PART NUMBER
1/2" 90° Hose Barb	QC(f)	1 1/16" (43 mm)	2 19/64" (58 mm)	1 5/8" (41 mm)	1/2" (12 mm)	45529-90-1/2
3/4" 90° Hose Barb					3/4" (19 mm)	45529-90-3/4
1" 90° Hose Barb					1" (25 mm)	45529-90-1

Note: O-ring and clip included.

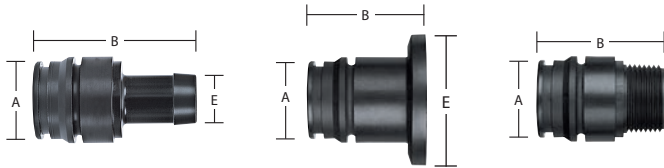

Male Quick Connect Fittings

DESCRIPTION	SERIES	"A"	"B"	"E"	PART NUMBER
50-Series Flange	QC(m)	1 3/16" (33 mm)	1 3/16" (46 mm)	2" (51 mm)	CP46029-PP
3/4" Male Pipe Thread			2" (51 mm)		CP45527-NYB
1" Male Pipe Thread					CP45526-NYB
3/4" Hose Barb*			2 7/16" (62 mm)	3/4" (19 mm)	45529-3/4M
1" Hose Barb*			1" (25 mm)		45529-1M

Note: Items marked with "*" include clip and O-ring.

- Large Quick connect fittings are used exclusively for 430 manifold inlets.
- Rated to 215 PSI (15 bar).

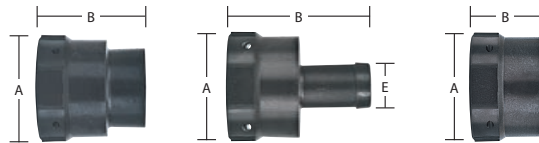

Large Quick Connect Threaded Fitting

DESCRIPTION	SERIES	"A"	"B"	PART NUMBER
1/4" Female Thread (Gauge Port)	Large Quick Connect	2 1/2" (64 mm)	2 1/4" (57 mm)	(B)58456-1/4
3/4" Female Thread				(B)58456-3/4
1" Female Thread				(B)58456-1
1 1/4" Female Thread				(B)58456-1-1/4
1 1/2" Female Thread				(B)58456-1-1/2

Note: O-ring and clip included.

(B)=BSPT

Large Quick Connect Cap Fitting

DESCRIPTION	SERIES	"A"	"B"	PART NUMBER
Cap Fitting	Large Quick Connect	2 1/2" (64 mm)	1 5/8" (41 mm)	58456-C

Note: O-ring and clip included.



Clip and O-Ring

DESCRIPTION	PART NUMBER
Retaining Clip 302SS	CP37166-1-302SS
O-Ring (Viton®)	CP7717-3-912-VI

Large Quick Connect Straight Hose Barb Fitting

DESCRIPTION	SERIES	"A"	"B"	"E"	PART NUMBER	
1" Straight Hose Barb	Large Quick Connect	2 1/2" (64 mm)	3 1/4" (83 mm)	1" (25 mm)	58456-1000	
1 1/4" Straight Hose Barb				1 1/4" (32 mm)	58456-1250	
1 1/2" Straight Hose Barb				3 1/2" (89 mm)	1 1/2" (38 mm)	58456-1500
2" Straight Hose Barb				4" (102 mm)	2" (51 mm)	58456-2000

Note: O-ring and clip included.

Clip and O-Ring

DESCRIPTION	PART NUMBER
Retaining Clip 302SS	CP58439-302SS
O-Ring (Viton®)	CP7717-M40X4-VI





Note: TeeJet Technologies recommends the use of sealed connectors to improve reliability and prolong component life.

CHART 1: CONNECTOR CODES

	AMP MALE FASTON CONNECTOR				AMP FEMALE FASTON CONNECTOR			
		<p>Note: No pin-out code needed with these connectors.</p> <p>2-PIN = CODE A 3-PIN = CODE J</p>				<p>Note: No pin-out code needed with these connectors.</p> <p>2-PIN = CODE B 3-PIN = CODE K</p>		
2-PIN OR 3-PIN	AMP FEMALE MATE-N-LOK® CONNECTOR (SEALED)				AMP MALE MATE-N-LOK® CONNECTOR (SEALED)			
	<p>Pin 1 — Pin 2 —</p> <p>2-PIN = CODE C</p>		<p>Pin 1 — Pin 2 — Pin 3 —</p> <p>3-PIN = CODE L</p>		<p>Pin 1 — Pin 2 —</p> <p>2-PIN = CODE D</p>		<p>Pin 1 — Pin 2 — Pin 3 —</p> <p>3-PIN = CODE M</p>	
	PACKARD WEATHER PACK SHROUD CONNECTOR (SEALED)				PACKARD WEATHER PACK TOWER CONNECTOR (SEALED)			
	<p>2-PIN = CODE E</p>		<p>3-PIN = CODE O</p>		<p>2-PIN = CODE F</p>		<p>3-PIN = CODE P</p>	
	DEUTSCH DT FEMALE CONNECTOR (SEALED)				DEUTSCH DT MALE CONNECTOR (SEALED)			
	<p>2-PIN = CODE G</p>		<p>3-PIN = CODE Q</p>		<p>2-PIN = CODE H</p>		<p>3-PIN = CODE R</p>	
PACKARD METRIPACK FEMALE CONNECTOR (SEALED)				JST VH FEMALE CONNECTOR (SEALED)				
<p>3-PIN = CODE S</p>				<p>2-PIN = CODE I</p> <p>3-PIN = CODE T</p>				
4-PIN	PACKARD WEATHER PACK SHROUD CONNECTOR (SEALED)				PACKARD WEATHER PACK TOWER CONNECTOR (SEALED)			
	<p>4-PIN = CODE U</p>				<p>Note: "VX" connector style is used to connect valves to many TeeJet controller harnesses.</p> <p>4-PIN = CODE V</p>			
	DEUTSCH DT FEMALE CONNECTOR (SEALED)							
<p>4-PIN = CODE W</p>								

CHART 2: PIN-OUT CODES

CODE LETTER	CONNECTOR POSITION				CODE LETTER	CONNECTOR POSITION			
	A OR 1	B OR 2	C OR 3	D OR 4		A OR 1	B OR 2	C OR 3	D OR 4
A	R	W	P	B	M	P	R	W	B
B	R	W	B	P	N	P	R	B	W
C	R	B	W	P	O	P	W	R	B
D	R	B	P	W	P	P	W	B	R
E	R	P	W	B	Q	P	B	R	W
F	R	P	B	W	R	P	B	W	R
G	W	R	B	P	S	B	R	W	P
H	W	R	P	B	T	B	R	P	W
I	W	P	R	B	U	B	W	R	P
J	W	P	B	R	V	B	W	P	R
K	W	B	R	P	W	B	P	R	W
L	W	B	P	R	X	B	P	W	R

How to order:

This system is to be used for 344B and 356B ball valves and 440B, 450B, 460B and 490B ball valve manifolds equipped with electrical connectors. Connector and pin-outs are to be specified in valve or manifold part number when ordering.

Note: On 2-pin connectors, only pin-out code C or S is used.

First: Specify code for connector desired (See Chart 1).

Second: Specify appropriate wire pin-out arrangement (See Chart 2).

Example:

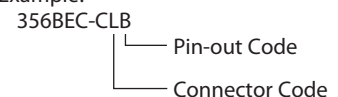

Wire Codes:

- R = Red (+12V)
- W = White (Switched)
- P = Plugged
- B = Black (Ground)



DirectoValve® 2-Way Electrically Operated Solenoid Valves

AA144P-, AA144A-, AA145H-, DirectoValve Control Valves

- Direct acting; large internal flow chamber without pilot hole reduces chance of clogging.
- Stainless steel wetted parts provide additional corrosion resistance.

- Operate on 12 VDC system.
- Maximum pressure of 100 PSI (7 bar).
- Encapsulated solenoid coil can be changed without removing valve from system.

- EPDM diaphragms and seat washers, Viton® optional.
- Continuous flow through bypass connection, with flow to spray line controlled by valve "on-off" action.



AA144P



AA144P-3
(Three Unit)

AA144P DirectoValve Control Valves

- Flow Rate: 10 GPM (38 l/min) at 5 PSI (0.34 bar) pressure drop, 14 GPM (53 l/min) at 10 PSI (0.69 bar) pressure drop.
- 2.5 amp current draw.
- Polypropylene body for chemical resistance.

- Fabric reinforced Viton diaphragms and seat washers.
- No stroke adjustment required.
- Corrosion resistant, 430SS solenoid grade armature and armature stop.
- Encapsulated coil and magnetic circuit.

How to order:

To order, specify AA144P- then "1", "2" or "3" to indicate number of units.
Example: AA(B)144P-3

MODEL NUMBER	INLET SIZE	OUTLET SIZE	CURRENT DRAW
AA(B)144P-*	¾"	½"	2.5 amp

(B) = BSPT

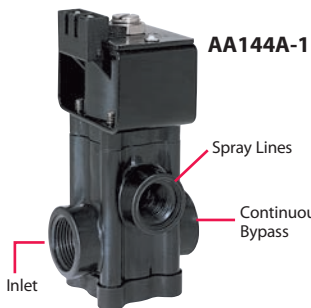

AA144A-1

AA144A Valve for Pressures up to 100 PSI (7 bar)

- Flow Rate: 10 GPM (38 l/min) at 5 PSI (0.34 bar) pressure drop, 14 GPM (53 l/min) at 10 PSI (0.69 bar) pressure drop.
- Can be ganged with other 144A DirectoValve control valves.
- 2.5 amp current draw.
- Polypropylene body for chemical resistance.
- Fabric reinforced diaphragms.

- Also available as 2- or 3-unit assembly.

How to order:

To order, specify AA144A- then "1", "2" or "3" to indicate number of units.
Example: AA(B)144A-3

AA144A-3
(Three Unit)



MODEL NUMBER	INLET SIZE	OUTLET SIZE	CURRENT DRAW
AA(B)144A-*	¾"	½"	2.5 amp

(B) = BSPT



AA145H

AA145H Control Valves

- Flow Rate: 15 GPM (57 l/min) at 5 PSI (0.34 bar) pressure drop, 21 GPM (79 l/min) at 10 PSI (0.69 bar) pressure drop.
- Can be ganged with other 145H DirectoValve control valves.
- 2.9 amp current draw.
- Fiberglass reinforced Nylon body.

How to order:

Specify part number.
Example: AA145H-1

MODEL NUMBER	INLET SIZE	OUTLET SIZE	CURRENT DRAW
AA145H-1	1"	1"	2.9 amp



AA144P-1-3

AA144P-1-3 DirectoValve Control Valves

The 144P-1-3 three-way solenoid-operated DirectoValve control valve was specifically designed to provide bypass control in spraying applications. When used with part number 23520-PP throttling valve or a 4916 metering orifice plate in the bypass line, it can provide for a constant pressure spray system.

- For pressure to 65 PSI (4.5 bar).
- Flow Rate: 8 GPM (30 l/min) at 5 PSI (0.34 bar) pressure drop, 11 GPM (42 l/min) at 10 PSI (0.69 bar) pressure drop.
- Fabric-reinforced Viton® diaphragms.

- Nylon encapsulated 12 VDC coil with 1/4" Quick Connect terminals.
- Power requirement 2.5 amp.
- Glass-filled polypropylene (black) valve body.
- Internal metal parts are stainless steel.
- No stroke adjustment needed.
- Corrosion resistant, 430SS solenoid grade armature and armature stop.

How to order: Specify part number.
Example: AA(B)144P-1-3

Note: 23520 Throttling Valve not included. See page 123 for more information.



AA144P-3-3
(Three Unit)

AA144A-1-3 DirectoValve Control Valves

The three-way solenoid-operated DirectoValve control valve bypasses boom flow to maintain constant spraying pressure when one or more boom sections are shut off. To maintain pressure with a 23520 Throttling Valve, Outlet 2 must be throttled to match the total capacity of the nozzles on that boom section.

- For pressures to 65 PSI (4.5 bar).
- Flow Rate: 8 GPM (30 l/min) at 5 PSI (0.34 bar) pressure drop, 11 GPM (42 l/min) at 10 PSI (0.69 bar) pressure drop

- 2.5 amp current draw.
- Encapsulated 12 VDC coil can be easily changed without removing valve from line.
- Polypropylene body for chemical resistance.
- Stainless steel internal metal parts.
- Chemical resistant EPDM diaphragms and seat washers.

How to order:

As with the 144A DirectoValve, the 144A-1-3 can be supplied as a 2-unit and 3-unit assembly. When ordering, specify 144A-2-3 or 144A-3-3.

Note: 23520 Throttling Valve not included. See page 123 for more information.



AA144A-3-3
(Three Unit)

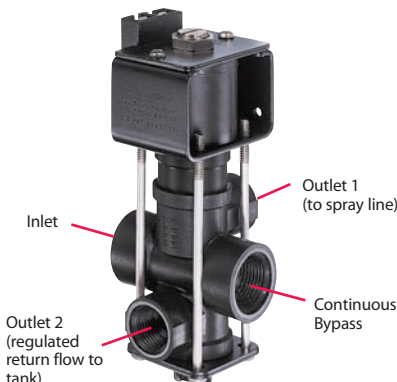

AA144A-1-3

MODEL NUMBER	NUMBER OF UNITS IN ASSEMBLY	SPRAY LINE CONNECTION	CONTINUOUS FLOW INLET BYPASS CONNECTION
AA(B)144P-1-3	1	1/2"	3/4"
AA(B)144P-2-3	2	1/2"	3/4"
AA(B)144P-3-3	3	1/2"	3/4"
AA(B)144A-1-3	1	1/2"	3/4"
AA(B)144A-2-3	2	1/2"	3/4"
AA(B)144A-3-3	3	1/2"	3/4"

(B) = BSPT



DirectoValve® 340 Series 2-Way Manual Shutoff Ball Valves



AA(B)344M-NYB

344M-NYB 2-Way Nylon Manual Ball Valves

- Quarter turn of handle from shutoff to full flow.
- 3/4" or 1" NPT and BSPT (F) connection.
- Wetted parts: Nylon, Teflon®, polypropylene and Viton®.

How to order:
Specify valve number.
Example: AA(B)344M-2-1

AA(B)344M-NYB

VALVE NUMBER	MAXIMUM PRESSURE	NUMBER OF OUTLETS	CONNECTION SIZE
AA(B)344M-2-3/4	300 PSI (20 bar)	1	3/4"
AA(B)344M-2-1		1	1"

Flow Rate: 5 PSI (0.34 bar) pressure drop for 32 GPM (121 l/min) flow.

(B) = BSPT



AA(B)343M-PP

340M-PP Series 2-Way Manual Ball Valves

- Quarter turn of handle from shutoff to full flow.
- 3/8", 1/2", 3/4", 1", 1 1/4" or 1 1/2" NPT and BSPT (F) connection.
- Wetted parts: glass-reinforced polypropylene, Teflon and Viton.

How to order:
Specify valve number.
Example: AA(B)343M-2-3/8-PP

AA(B)343M-PP

VALVE NUMBER	MAXIMUM PRESSURE	NUMBER OF OUTLETS	CONNECTION SIZE
AA(B)343M-2-3/8-PP	150 PSI (10 bar)	1	3/8"
AA(B)343M-2-1/2-PP		1	1/2"

Flow Rate: 5 PSI (0.34 bar) pressure drop for 11 GPM (42 l/min) flow.

(B) = BSPT



AA(B)344M-PP

How to order:
Specify valve number.
Example: AA(B)344M-2-3/4-PP

AA(B)344M-PP

VALVE NUMBER	MAXIMUM PRESSURE	NUMBER OF OUTLETS	CONNECTION SIZE
AA(B)344M-2-3/4-PP	125 PSI (9 bar)	1	3/4"
AA(B)344M-2-1-PP		1	1"

Flow Rate: 5 PSI (0.34 bar) pressure drop for 32 GPM (121 l/min) flow.

(B) = BSPT



AA(B)346M-PP

How to order:
Specify valve number.
Example: AA(B)346M-2-1-1/4-PP

AA(B)346M-PP

VALVE NUMBER	MAXIMUM PRESSURE	NUMBER OF OUTLETS	CONNECTION SIZE
AA(B)346M-2-1-1/4-PP	125 PSI (9 bar)	1	1 1/4"
AA(B)346M-2-1-1/2-PP		1	1 1/2"

Flow Rate: 5 PSI (0.34 bar) pressure drop for 100 GPM (379 l/min) flow.

(B) = BSPT



AA(B)344M-NYB

344M-NYB 3-Way Nylon Manual Ball Valves

- 3-way version diverts flow to either outlet; no shutoff.
- 3/4" or 1" NPT and BSPT (F) connection.

- Wetted parts: Nylon, virgin Teflon®, polypropylene and Viton®.

How to order:
Specify valve number.
Example: AA(B)344M-3-1

AA(B)344M-NYB

VALVE NUMBER	MAXIMUM PRESSURE	NUMBER OF OUTLETS	CONNECTION SIZE
AA(B)344M-3-3/4	300 PSI (20 bar)	2	3/4"
AA(B)344M-3-1		2	1"

Flow Rate: 5 PSI (0.34 bar) pressure drop for 24 GPM (91 l/min) flow.

(B) = BSPT



AA(B)343M-PP

340M-PP Series 3-Way Manual Ball Valves

- 3-way version diverts flow to either outlet; no shutoff.
- 3/8", 1/2", 3/4", 1", 1 1/4" or 1 1/2" NPT and BSPT (F) connection.

- Wetted parts: glass-reinforced polypropylene, virgin Teflon and Viton.

How to order:
Specify valve number.
Example: AA(B)343M-3-3/8-PP

AA(B)343M-PP

VALVE NUMBER	MAXIMUM PRESSURE	NUMBER OF OUTLETS	CONNECTION SIZE
AA(B)343M-3-3/8-PP	150 PSI (10 bar)	2	3/8"
AA(B)343M-3-1/2-PP		2	1/2"

Flow Rate: 5 PSI (0.34 bar) pressure drop for 8 GPM (30 l/min) flow.

(B) = BSPT



AA(B)344M-PP

How to order:

Specify valve number.
Example: AA(B)344M-3-3/4-PP

AA(B)344M-PP

VALVE NUMBER	MAXIMUM PRESSURE	NUMBER OF OUTLETS	CONNECTION SIZE
AA(B)344M-3-3/4-PP	125 PSI (9 bar)	2	3/4"
AA(B)344M-3-1-PP		2	1"

Flow Rate: 5 PSI (0.34 bar) pressure drop for 24 GPM (91 l/min) flow.

(B) = BSPT



AA(B)346M-PP

How to order:

Specify valve number.
Example: AA(B)346M-3-1-1/4-PP

AA(B)346M-PP

VALVE NUMBER	MAXIMUM PRESSURE	NUMBER OF OUTLETS	CONNECTION SIZE
AA(B)346M-3-1-1/4-PP	125 PSI (9 bar)	2	1 1/4"
AA(B)346M-3-1-1/2-PP		2	1 1/2"

Flow Rate: 5 PSI (0.34 bar) pressure drop for 64 GPM (242 l/min) flow.

(B) = BSPT



Piston-Type Pressure Relief/Regulating Valves

Bypasses excess liquid. Adjustable to maintain control of line pressure at any pressure within the valve's operating range. Selected pressure setting firmly held in place by locknut. Extra large valve passages to handle large flows.



Model 23120

Model 23120

- 302 stainless steel spring and EPDM O-ring.
- Excellent chemical resistance.
- 1/4" port for pressure gauge pipe plug included.

Model 23120A

- Same as 23120 but with 316SS spring and Viton® O-ring.

How to order:

Specify valve number.
Example: (B)23120-1/2-PP

VALVE NUMBER	INLET & PIPE CONNECTIONS	MATERIAL	PRESSURE RANGE
(B)23120*-PP	1/2" or 3/4"	Polypropylene	150 PSI (10 bar)
(B)23120A*-PP	1/2" or 3/4"	Polypropylene	150 PSI (10 bar)
(B)23120*-PP-60	1/2" or 3/4"	Polypropylene	60 PSI (4 bar)
(B)23120*-PP-60-VI	1/2" or 3/4"	Polypropylene/Viton®	60 PSI (4 bar)

*Specify pipe size.

(B) = BSPT



Model 6815

Model 6815

- Other models for high pressures up to 1,200 PSI (82 bar) are also available.
- Brass also available with hardened stainless steel seat.

How to order:

Specify valve number.
Example: (B)6815-1/2-50

VALVE NUMBER	INLET & PIPE CONNECTIONS	MATERIAL	PRESSURE RANGE
(B)6815*-50	1/2" or 3/4"	Brass or Aluminum	50 PSI (3.5 bar)
(B)6815*-300	1/2" or 3/4"	Brass or Aluminum	300 PSI (20 bar)
(B)6815*-700	1/2" or 3/4"	Brass or Aluminum	700 PSI (48 bar)

*Specify pipe size.

(B) = BSPT



Model 110-1/4 and 110-3/8



Model 110-1, 110-1-1/4 and 110-1-1/2

Model 110

- Removable bonnet for servicing unit without removing valve from line.

How to order:

Specify valve number.
Example: AA(B)110-1/4-300

VALVE NUMBER	INLET & PIPE CONNECTIONS	MATERIAL	PRESSURE RANGE
AA(B)110*-300	1/4" or 3/8"	Brass	300 PSI (20 bar)
AA(B)110*-700	1/4" or 3/8"	Brass	700 PSI (48 bar)
AA(B)110-1	1"	Brass, Aluminum or Ductile Iron	150 PSI (10 bar)
AA(B)110-1-1/4	1 1/4"	Brass, Aluminum or Ductile Iron	150 PSI (10 bar)
AA(B)110-1-1/2	1 1/2"	Brass, Aluminum or Ductile Iron	150 PSI (10 bar)

*Specify pipe size.

(B) = BSPT

Model 8460 Diaphragm-Type Pressure Relief/Regulating Valves

- Flow rate to 56 GPM (212 l/min) for 1/2" and 70 GPM (265 l/min) for 3/4".
- 8460*-50 uses stainless steel springs while 8460-* uses steel springs—responsive to the pressure range of each valve.
- Extra large valve passages to handle full flow from supply line.

- Positive locknut to hold adjustment screw firmly in place. Not affected by jarring and vibration.

How to order:

Specify valve number.
Example: 8460-1/2-50



Model 8460

VALVE NUMBER	INLET & PIPE CONNECTIONS	MATERIAL		PRESSURE RANGE
		INLET BODY	BONNET	
8460*-50	1/2" or 3/4"	Nylon	Aluminum	50 PSI (3.5 bar)
8460*	1/2" or 3/4"	Nylon	Aluminum	300 PSI (20 bar)

*Specify pipe size.

DirectoValve® Manual Control Valve



Model 6B

- Molded of corrosion resistant materials; all wetted parts are polypropylene, stainless steel and polyethylene.
- Maximum pressure of 150 PSI (10 bar).
- Flow Rate: 12 GPM (47 l/min) at 5 PSI (0.34 bar) pressure drop, 17 GPM (64 l/min) at 10 PSI (0.69 bar) pressure drop.
- Molded-in mounting flange and ¼" NPT gauge port.
- Valves can be ganged together using hex nipple for multiple boom control.
- Easily repaired without removing valve from spray line.

How to order:

Example: AA(B)6B
(B) = BSPT

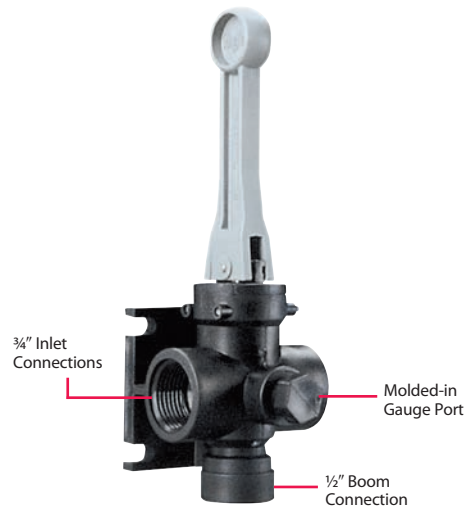

TeeValve® Control Valves

For Selective Control of Three-Section Boom Sprayers at Pressures up to 300 PSI (20 bar).

- Use to open any of three boom section lines in any desired combination.
- Raise lever to open, lower lever to close the valve without changing the indexed position.
- Aluminum construction with stainless steel and plastic internal parts for maximum corrosion resistance.

How to order:

Example: AA17Y

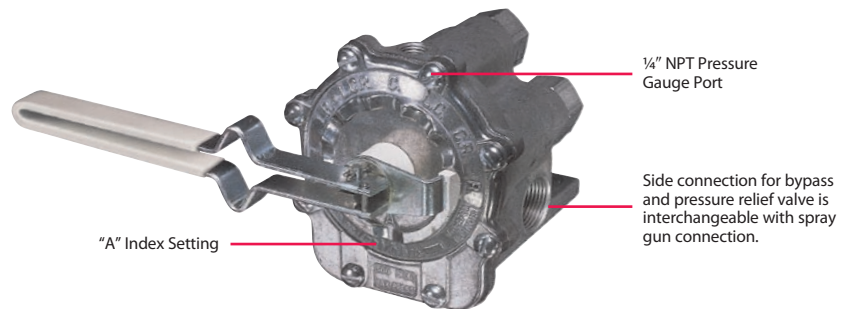

Model AA17

MODEL NUMBER	MATERIAL	MAXIMUM PRESSURE	INLET	(3) BOOM OUTLETS	ACCESSORY OUTLET
AA17Y	Aluminum, Polymer, SS	300 PSI (20 bar)	1" NPT	¾" (F)	¾" (F)
AA17L	Aluminum, Polymer, SS	300 PSI (20 bar)	¾" NPT	¾" (F)	¾" (F)

TeeJet® Throttling Valves

For regulating flow in systems equipped with centrifugal pumps where sensitive regulation is required or to control flow in jet agitator return lines. Locknut holds pressure setting firmly in place.

Type 23520



- Polypropylene construction for excellent chemical resistance.
- Pressures to 150 PSI (10 bar).
- ½" and ¾" NPT or BSPT connections.
- Flow rate at 40 PSI (3 bar) is 16 GPM (63 l/min) for ½" size and 34 GPM (136 l/min) for ¾" size.

How to order:

Example: (B)23520-1/2-PP
(B) = BSPT

Type 12690



- Pressures to 125 PSI (9 bar).
- Constructed of Nylon, Celcon®, aluminum, steel and stainless steel.
- Choice of ½" or ¾" NPT connections.
- Flow rate at 40 PSI (3 bar) is 36 GPM (142 l/min) for ½" size and 52 GPM (205 l/min) for ¾" size.

How to order:

Example: 12690-1/2-NYB

Type 12795



- Pressures to 150 PSI (10 bar).
- Available in brass, aluminum or ductile iron.
- Choice of 1", 1¼" or 1½" NPT connections.
- Flow rate at 40 PSI (3 bar) is 116 GPM (453 l/min) for 1" and 1¼" sizes and 172 GPM (679 l/min) for 1½" size.

How to order:

Example: 12795-1



TeeJet® Tip Strainers



MESH SIZE
16
24
25
50
80
100
200

TeeJet Strainers

Strainers protect spray tip orifices from clogging and damage. Stainless steel screens are available in 24, 50, 80, 100 and 200 mesh. 19845 tip strainers are available in 25 and 50 mesh only.

TEEJET STRAINER NUMBER	STRAINER BODY AND CAP MATERIAL	MESH SCREEN MATERIAL
5053-*-SS	Brass	Stainless Steel
8079-PP-*	Polypropylene	Stainless Steel
6051-SS-*	Stainless Steel	Stainless Steel
19845-*-PP	Polypropylene	Polypropylene

*Specify mesh size when ordering.

55215 Self-Retaining Tip Strainer

Features:

- For Use with Quick TeeJet® caps.
- Allows tip strainer to be easily removed from nozzle body for cleaning.
- 50 or 100 mesh color-coded strainer with optional EPDM or Viton® gasket.



STRAINER NUMBER	MESH
55215-50-*	50
55215-100-*	100

How to order:

Example: 55215-50-EPR, EPDM gasket
55215-50-VI, Viton gasket

*Identify gasket material.

TeeJet Slotted Strainers

One-piece strainers for use with liquids containing suspended solids.



TEEJET STRAINER NUMBER	AVAILABLE MATERIAL	EQUIVALENT TO MESH SIZE	COLOR CODE (NYLON VERSIONS ONLY)
4514-*-10	Brass or Nylon	50	
4514-*-20	Brass, Aluminum or Nylon	25	
4514-*-32	Brass, Aluminum or Nylon	16	

*Above numbers for brass. For Nylon add "NY". For aluminum add "AL".

4193A TeeJet Strainer and Check Valve

Minimizes nozzle dripping; fits all TeeJet nozzles. Ball check opens at 5 PSI (0.34 bar). Recommended for flow rates up to 0.8 GPM (3 l/min). 24, 50, 100 and 200 mesh screens. Not for use with AI or DG tips.



Note: Use of these ball check valves results in a pressure drop of 5 PSI (0.34 bar) to 10 PSI (0.7 bar) depending on spring rating.

CHECK VALVE NUMBER	BODY AND CAP SCREW MATERIAL	MESH SCREEN MATERIAL	BALL MATERIAL
4193A- *- *	Brass	Stainless Steel	Stainless Steel
4193A-SS- *- *	Stainless Steel	Stainless Steel	Stainless Steel
4193A-PP- *- *	Polypropylene	Stainless Steel	Viton
4193A-PP-*-SS-*	Polypropylene	Stainless Steel	Stainless Steel

*When ordering, specify spring rating and screen mesh size.



TeeJet® Line Strainers

The AA122 line strainer features a compact size that is well suited for small agricultural and turf sprayers. The AA122 is constructed of polypropylene head and bowl with stainless steel screen for excellent chemical resistance and is available with 1/2" or 3/4" (F) NPT pipe

connections. The maximum pressure rating is 150 PSI (10 bar). A Quick Connect version of the 122 is also available for easy installation on valves/manifolds equipped with Quick Connect outlets. The maximum pressure rating for this version is 215 PSI (15 bar).



23174 45102



AA122ML-QC
Compact
Liquid Strainer

AA122-PP
Compact
Liquid Strainer

37270-122-PP
Flush-Out
Strainer

37270-122-PP

The screen may be periodically flushed by opening a valve (valve not included) in flush-out line.

STRAINER NUMBER	PIPE CONN.	APPROXIMATE FLOW RATE WITH 5 PSI (0.34 bar) PRESSURE DROP IN GPM (l/min)	SCREEN	
			MESH SIZE	PART NUMBER
AA122ML-QC-PP-*	QC	18 (68)		
AA(B)122-1/2-PP-*	1/2"	12 (45)	16	CP23174-1-304SS
AA(B)122-3/4-PP-*	3/4"	16 (60)	30	CP23174-2-304SS
AA(B)122ML-1/2-PP-*	1/2"	12 (45)	50	CP45102-3-SSPP
AA(B)122ML-3/4-PP-*	3/4"	16 (60)	80	CP45102-4-SSPP
(B)37270-122-1/2-PP-*	1/2"	12 (45)	100	CP45102-5-SSPP
(B)37270-122-3/4-PP-*	3/4"	16 (60)	200	CP23174-7-304SS

* = Mesh Size

(B) = BSPT

Replacement Head Gasket: CP23173-EPR-(VI) or CP7717-M38x4-VI (for AA122ML-QC only).



AA126ML-F50



AA126ML-3 or -4

AA126 Flush-out Line Strainer

Features:

- 200 PSI (14 bar) maximum pressure rating.
- Strainer head and bowl are made of glass-filled polypropylene with EPDM gasket.
- Screens are made of 304SS with color-coded polypropylene frames and are removable for cleaning.
- Removable cap and O-ring for flush-out or self-cleaning operations.
- Integral mounting provision allows the strainer to be attached to machine using M8 or 5/16" diameter bolts.
- Available with 3/4", 1" NPT or BSPT (F) threads and 50 series flange fitting connections for easy assembly. For information on flange fittings see pages 102 and 103.
- Uses same screen as the AA124A line strainer.



16903

STRAINER NUMBER	PIPE/FLANGE CONNECTION (F)	FLOW RATE WITH 5 PSI (0.34 bar) PRESSURE DROP	SCREEN	MESH SIZE*
AA(B)126ML-F50-*	50 Series Flange	35 GPM (132 l/min)	CP16903-1-SSPP	16
			CP16903-3-SSPP	30
AA(B)126ML-3-*	3/4"	23 GPM (87 l/min)	CP16903-4-SSPP	50
			CP16903-5-SSPP	80
AA(B)126ML-4-*	1"	35 GPM (132 l/min)	CP16903-6-SSPP	100
			CP16903-7-SSPP	200

*Specify mesh size

Replacement Head Gasket: CP50494-EPR(-VI)



AA126ML-F75



AA126ML-5 or -6

AA126 Flush-out Line Strainer

Features:

- 200 PSI (14 bar) maximum pressure rating.
- Strainer head and bowl are made of glass-filled polypropylene with EPDM gasket.
- Screens are made of 304SS with color-coded polypropylene frames and are removable for cleaning.
- Removable cap and gasket for flush-out or self-cleaning operations.
- Integral mounting provision allows the strainer to be attached to machine using M10 or 3/8" diameter bolts.
- Available with 1 1/4", 1 1/2" NPT or BSPT (F) threads and 75 series flange fitting connections for easy assembly. For information on flange fittings see pages 102 and 103.
- Uses same screen as the AA124 line strainer.



15941

STRAINER NUMBER	PIPE/FLANGE CONNECTION (F)	FLOW RATE WITH 5 PSI (0.34 bar) PRESSURE DROP	SCREEN	MESH SIZE*
AA(B)126ML-F75-*	75 Series Flange	77 GPM (291 l/min)	CP15941-1-SSPP	16
			CP15941-2-SSPP	30
AA(B)126ML-5-*	1 1/4"	59 GPM (223 l/min)	CP15941-3-SSPP	50
			CP15941-4-SSPP	80
AA(B)126ML-6-*	1 1/2"	77 GPM (291 l/min)	CP15941-5-SSPP	100
			CP15941-6-SSPP	120

*Specify mesh size

Replacement Head Gasket: CP48656-EPR(-VI)



Self-Cleaning Line Strainers

The TeeJet self-cleaning strainer extends your spraying time with a self-cleaning feature that minimizes clogging. Mounted on the discharge side of the pump, the strainer uses excess pump flow to bypass clogging particles back to the spray tank.

The tapered inner cylinder inside the entire length of the screen provides a gap between the screen face and the cylinder. This gap causes the inlet fluid to flow at a high velocity past the screen face providing for a continuous wash down of particles to the bypass line. In order for the wash down to occur, a minimum flow rate of 6 GPM (23 l/min) for 3/4" and 1" sizes and 8 GPM (30 l/min) for 1 1/4" and 1 1/2" sizes is required through the bypass line.

- Available with or without mounting lugs.
- AA126 strainers are made of glass filled polypropylene and are available in 3/4", 1", 1 1/4", 1 1/2" (F) NPT or BSPT thread as well as 50 and 75 series flange connection.
- AA124 strainers are made of an aluminum head with a nylon bowl and are available in 3/4", 1", 1 1/4", 1 1/2" (F) NPT or BSPT thread.
- Both use an all stainless steel strainer element.
- Strainers with mounting lugs are designated by "ML".

AA(B)126MLSC

(Glass-filled Polypropylene)



AA(B)124ML-SC-AL

(Aluminum)



AA(B)124-SC-AL

(Aluminum)

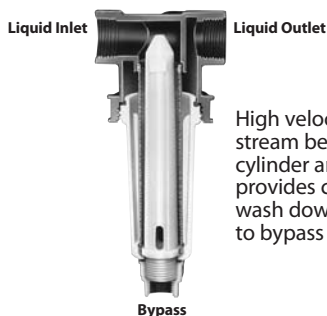

High velocity of liquid stream between cylinder and screen provides continuous wash down of particles to bypass line.

STRAINER NUMBER	PIPE CONN.	BYPASS PIPE CONN.	MATERIAL		MAX. PRESSURE PSI (bar)	MIN. BYPASS REQUIRED GPM (l/min)	SCREEN	
			HEAD	BOWL			MESH	NUMBER
AA(B)126MLSC-3-*	3/4" (F)	1/2" (F)	Polypropylene		200 (14)	6 (23)	16	CP12285- *SS
AA(B)124ML-3/4-SC-AL-*			Aluminum	Nylon	150 (10)			
AA(B)126MLSC-4-*	1" (F)		Polypropylene		200 (14)			
AA(B)124ML-1-SC-AL-*			Aluminum	Nylon	150 (10)			
AA(B)126MLSC-50F-*	Flange	3/4" (F)	Polypropylene		200 (14)	8 (30)	50	CP12290- *SS
AA(B)126MLSC-5-*	1 1/4" (F)		Polypropylene		200 (14)			
AA(B)124ML-1-1/4-SC-AL-*			Aluminum	Nylon	150 (10)			
AA(B)126MLSC-6-*	1 1/2" (F)		Polypropylene		200 (14)			
AA(B)124ML-1-1/2-SC-AL-*			Aluminum	Nylon	150 (10)			
AA(B)126MLSC-75F-*	Flange		Polypropylene		200 (14)		100	

STRAINER NUMBER	PIPE CONN.	BYPASS PIPE CONN.	MATERIAL		MAX. PRESSURE PSI (bar)	MIN. BYPASS REQUIRED GPM (l/min)	SCREEN	
			HEAD	BOWL			MESH	NUMBER
AA(B)124A-3/4-SC-AL-*	3/4" (F)	1/2" (F)	Aluminum	Nylon	150 (10)	6 (23)	16	CP12285- *SS
AA(B)124A-1-SC-AL-*							30	
AA(B)124-1-1/4-SC-AL-*	80							
AA(B)124-1-1/2-SC-AL-*	30							
	1 1/4" (F)	3/4" (F)				8 (30)	80	CP12290- *SS
							100	

How to order:

Specify strainer number.

Example: AA126ML-4SC-50

To order screen only, specify screen number.

Example: CP12285-1-SS

SCREEN	
MESH	NUMBER
16	CP12285-1-SS
30	CP12285-4-SS
50	CP12285-2-SS
80	CP12285-3-SS
100	CP12285-6-SS
16	CP12290-1-SS
30	CP12290-2-SS
50	CP12290-3-SS
80	CP12290-4-SS
100	CP12290-8-SS





Strainer heads are available in polypropylene, Nylon, aluminum and cast iron. Bowl materials include polypropylene or Nylon. Each strainer includes stainless steel screen (with polypropylene frames on ¾" to 1½" pipe sizes). Maximum temperatures up to 38°C/100°F.

Viton® O-ring seal supplied with ¾" and 1" Nylon models; EPDM supplied with ¾" and 1" polypropylene models; Buna-N gaskets supplied with 1¼" and 1½" sizes. Viton optional.

AA(B)124A-AL



STRAINER NUMBER	PIPE CONN.	APPROXIMATE FLOW RATE WITH 5 PSI (0.34 bar) PRESSURE DROP IN GPM (l/min)	PRESSURE RATING PSI (bar)	SCREEN	
				MESH SIZE	PART NUMBER
AA(B)124A-3/4-AL-*	¾"	23 (87)	150 (10)	16	CP16903-1-SSPP
				20	CP16903-2-SSPP
				30	CP16903-3-SSPP
				50	CP16903-4-SSPP
				80	CP16903-5-SSPP
AA(B)124A-1-AL-*	1"	34 (129)	150 (10)	100	CP16903-6-SSPP
				200	CP16903-7-SSPP



16903

* = Mesh Size

(B) = BSPT

AA(B)124-AL



STRAINER NUMBER	PIPE CONN.	APPROXIMATE FLOW RATE WITH 5 PSI (0.34 bar) PRESSURE DROP IN GPM (l/min)	PRESSURE RATING PSI (bar)	SCREEN	
				MESH SIZE	PART NUMBER
AA(B)124-1-1/4-AL-*	1¼"	60 (230)	150 (10)	16	CP15941-1-SSPP
				30	CP15941-2-SSPP
				50	CP15941-3-SSPP
AA(B)124-1-1/2-AL-*	1½"	70 (260)	150 (10)	80	CP15941-4-SSPP
				100	CP15941-5-SSPP
				120	CP15941-6-SSPP
AA(B)124-2-AL-*	2"	160 (610)	150 (10)	16	CP14634-1-SS
				30	CP14634-2-SS
				50	CP14634-3-SS
AA(B)124-2-1/2-AL-*	2½"	170 (640)	150 (10)	80	CP14634-4-SS
				100	CP14634-8-SS



15941



14634

* = Mesh Size

(B) = BSPT

AA(B)124ML-AL

(with mounting holes)



STRAINER NUMBER	PIPE CONN.	APPROXIMATE FLOW RATE WITH 5 PSI (0.34 bar) PRESSURE DROP IN GPM (l/min)	PRESSURE RATING PSI (bar)	SCREEN	
				MESH SIZE	PART NUMBER
AA(B)124ML-3/4-AL-*	¾"	23 (87)	150 (10)	16	CP16903-1-SSPP
				20	CP16903-2-SSPP
				30	CP16903-3-SSPP
				50	CP16903-4-SSPP
				80	CP16903-5-SSPP
AA(B)124ML-1-AL-*	1"	34 (129)	150 (10)	100	CP16903-6-SSPP
				200	CP16903-7-SSPP
				16	CP15941-1-SSPP
AA(B)124ML-1-1/4-AL-*	1¼"	60 (230)	150 (10)	30	CP15941-2-SSPP
				50	CP15941-3-SSPP
				80	CP15941-4-SSPP
AA(B)124ML-1-1/2-AL-*	1½"	70 (260)	150 (10)	100	CP15941-5-SSPP
				120	CP15941-6-SSPP
				AA(B)124ML-2-AL-*	2"
30	CP14634-2-SS				
50	CP14634-3-SS				
AA(B)124ML-2-1/2-AL-*	2½"	170 (640)	150 (10)	80	CP14634-4-SS
				100	CP14634-8-SS



16903



15941



14634

* = Mesh Size

(B) = BSPT

How to order:

Specify strainer number, mesh size and material.

Example: AA(B)124-1-1/4-NYB-16 Nylon

To order screen only, specify screen number.

Example: CP15941-1-SSPP



GunJet® Spray Guns

For spot spraying, tree spraying, livestock spraying and power washing at pressures from 30 to 800 PSI.

To operate spray gun, handle is rotated 360° from shutoff to maximum flow position. As handle is turned, spray changes from initial cone spray through intermediate cone spray to straight stream. Spray tips are interchangeable orifice discs made of corrosion- and erosion-resistant stainless steel.

Choice of Materials and Capacities



GunJet Number AA2

Overall length 24", weight 3½ pounds, brass. ¾" garden hose thread (F) inlet connection. Also available in aluminum as GunJet AA2-AL, weight 1¼ pounds.



GunJet Number AA2A

Overall length 15", weight 2½ pounds, brass. ¾" garden hose thread (F) inlet connection. Also available in aluminum as GunJet AA2A-AL, weight 1 pound. Same design as GunJet AA2.

**SETTING "A"
WIDE ANGLE CONE SPRAY**

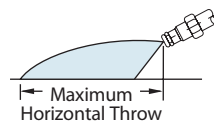

**SETTING "C"
STRAIGHT STREAM SPRAY**



GunJet Number AA143

Overall length 22¼", weight 1¼ pounds and only available in aluminum. Inlets are available with ¾" or GH (Garden Hose) female threads.

GUNJET NUMBER	ORIFICE DISC NUMBER	PERFORMANCE	LIQUID PRESSURE IN PSI			
			100 PSI		800 PSI	
			A	C	A	C
AA2-20	AY-SS 20	Capacity – GPM	.53	.90	1.5	2.5
		Max. Vert. Throw – ft.	—	25	—	33
		Max. Horiz. Throw – ft.	6	35	8	42
AA2-30	AY-SS 30	Capacity – GPM	.79	1.4	2.2	4.0
		Max. Vert. Throw – ft.	—	27	—	34
		Max. Horiz. Throw – ft.	7	38	9	45
AA2-45	AY-SS 45	Capacity – GPM	1.2	2.3	3.4	6.5
		Max. Vert. Throw – ft.	—	30	—	36
		Max. Horiz. Throw – ft.	8	41	9	48
AA2-60	AY-SS 60	Capacity – GPM	1.6	3.6	4.5	10
		Max. Vert. Throw – ft.	—	32	—	40
		Max. Horiz. Throw – ft.	9	44	10	52
AA2-90	AY-SS 90	Capacity – GPM	2.3	4.9	6.7	14
		Max. Vert. Throw – ft.	—	35	—	44
		Max. Horiz. Throw – ft.	10	47	12	57
AA2-120	AY-SS 120	Capacity – GPM	3.2	6.4	9.0	17
		Max. Vert. Throw – ft.	—	37	—	48
		Max. Horiz. Throw – ft.	11	49	13	62
AA2-180	AY-SS 180	Capacity – GPM	4.7	11	13	31
		Max. Vert. Throw – ft.	—	37	—	48
		Max. Horiz. Throw – ft.	12	49	14	62

How to order:

For complete gun, specify GunJet spray gun number and material.

Example: AA2-20, Brass or
AA2-AL20, Aluminum

To order orifice disc only, specify orifice disc number.

Example: AY-SS 20

GUNJET NUMBER	ORIFICE DISC NUMBER	PERFORMANCE	LIQUID PRESSURE IN PSI			
			100 PSI		800 PSI	
			A	C	A	C
AA143-AL-*2	D2	Capacity – GPM	.36	.36	1.0	1.0
		Max. Vert. Throw – ft.	—	22	—	26
		Max. Horiz. Throw – ft.	10	33	11	35
AA143-AL-*4	D4	Capacity – GPM	.82	.82	2.3	2.3
		Max. Vert. Throw – ft.	—	27	—	32
		Max. Horiz. Throw – ft.	10	36	11	40
AA143-AL-*6	D6	Capacity – GPM	1.7	1.8	4.9	5.1
		Max. Vert. Throw – ft.	—	33	—	38
		Max. Horiz. Throw – ft.	10	46	11	54
AA143-AL-*8	D8	Capacity – GPM	2.8	3.3	8.1	9.4
		Max. Vert. Throw – ft.	—	35.5	—	42
		Max. Horiz. Throw – ft.	10	54	11	60
AA143-AL-*10	D10	Capacity – GPM	3.9	4.9	11.2	13.9
		Max. Vert. Throw – ft.	—	37.5	—	44.5
		Max. Horiz. Throw – ft.	10.5	55	12	62

*Inlet size ¾" or GH.

How to order:

Examples: AA143-AL-3/4-6
AA143-AL-GH-6

To order orifice disc only, specify orifice disc number.

Example: D2





AA43 GunJet

Designed and built for heavy duty service. Stem extends through extension to valve seat located directly behind orifice disc for drip-free shutoff and instant operating response. Convenient trigger-lock for continuous spraying.

- Number AA43L for operating pressures up to 200 PSI.
- Number AA43H for operating pressures up to 800 PSI.
- Trigger handle control: ALL MODELS have 1/2" NPT or BSPT (F) inlet connections.



Hardened Stainless Steel Type D Orifice Discs

Choose one of five interchangeable orifice disc capacities. Other sizes may be available upon request. Discs are corrosion- and erosion-resistant.

SETTING "A"
WIDE ANGLE CONE SPRAY



As trigger is drawn back, valve moves from shutoff position to initial wide angle spray, to continuously narrower cone sprays, to

SETTING "C"
STRAIGHT STREAM SPRAY



final straight stream. Knurled ring behind trigger is adjustable to stop trigger at any desired position.

- Exposed packing nut for easy adjustment of packing.
- Available in aluminum or brass.



Hardened Stainless Steel Type DX-HSS Spray Tips

For spraying trees and other applications where maximum spray throw is required. Write for Data Sheet 6990.

Type 43L & 43H GunJet Spray Guns

MODEL NUMBER	OPERATING PRESSURE RANGE (PSI)	MATERIAL	OVERALL LENGTH (INCHES)
AA(B)43L-AL	Up to 200	Aluminum	22
AA(B)43H-AL	200-800	Aluminum	

(B) = BSPT



Type 43A GunJet Spray Guns

MODEL NUMBER	OPERATING PRESSURE RANGE (PSI)	MATERIAL	OVERALL LENGTH (INCHES)
AA(B)43LA-AL	Up to 200	Aluminum	13
AA(B)43HA-AL	200-800	Aluminum	

(B) = BSPT

Type 43LC-1/2 & 43HC-1/2 and GunJet Spray Guns

Types 43LC-1/2 and 43HC-1/2 have 1/2" NPT (F) outlet connections. Inlet connections are 1/2" NPT or BSPT (F).

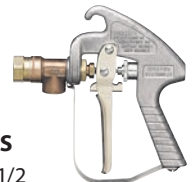

MODEL NUMBER	OPERATING PRESSURE RANGE (PSI)	MATERIAL	OVERALL LENGTH (INCHES)
AA(B)43LC-1/2	Up to 200	Brass	8
AA(B)43HC-1/2	200-800	Brass	

(B) = BSPT

GUNJET NUMBER	ORIFICE DISC NUMBER	PERFORMANCE	LIQUID PRESSURE IN PSI									
			40 PSI		100 PSI		200 PSI		400 PSI		800 PSI	
			A	C	A	C	A	C	A	C	A	C
AA(B)43L-AL2 AA(B)43H-AL2	D2	Capacity - GPM	.29	.30	.45	.47	.64	.66	.90	.94	1.3	1.3
		Max. Vert. Throw - ft.	—	22	—	22	—	23	—	24	—	26
		Max. Horiz. Throw - ft.	10	32	10	33	10	34	10.5	35	11	35
AA(B)43L-AL4 AA(B)43H-AL4	D4	Capacity - GPM	.60	.61	.92	.94	1.3	1.3	1.8	1.9	2.6	2.7
		Max. Vert. Throw - ft.	—	26	—	27	—	28	—	30	—	32
		Max. Horiz. Throw - ft.	10	36	10	36	10.5	37	11	39	11	40
AA(B)43L-AL6 AA(B)43H-AL6	D6	Capacity - GPM	1.2	1.3	1.9	2.0	2.7	2.9	3.8	4.1	5.3	5.8
		Max. Vert. Throw - ft.	—	31.5	—	33	—	34.5	—	36.5	—	38
		Max. Horiz. Throw - ft.	10	44	10	45	10.5	46	11	48	11	50
AA(B)43L-AL8 AA(B)43H-AL8	D8	Capacity - GPM	2.0	2.5	3.1	3.4	4.4	4.8	6.2	6.8	8.8	9.6
		Max. Vert. Throw - ft.	—	33	—	35.5	—	38	—	40.5	—	42
		Max. Horiz. Throw - ft.	10	45	10	46	10.5	47	11	49	11	51
AA(B)43L-AL10 AA(B)43H-AL10	D10	Capacity - GPM	2.6	3.2	4.1	5.0	5.8	7.1	8.2	10	10.2	14.1
		Max. Vert. Throw - ft.	—	35	—	37.5	—	40	—	42.5	—	44.5
		Max. Horiz. Throw - ft.	10	46	10.5	49	11	50	11.5	52	12	54

(B) = BSPT

How to order:

Specify complete GunJet spray gun number and material.
Example: AA(B)43L-AL4 Aluminum



TeeJet® Lawn Spray Guns



Model 25660

Features:

- Interchangeable nozzle tips are color-coded for easy identification of nozzle tip size.
- Nozzle tips provide a 45° full cone “showerhead” spray pattern.
- Convenient trigger lock for continuous spraying.
- Options available: hose shank swivel for inlet connection and extension wand and adapters for low-volume and spot spraying.
- Maximum operating pressure of 200 PSI (14 bar).
- Made of Nylon with Viton® O-rings and stainless steel springs.

MODEL NUMBER	NOZZLE TIP NUMBER	CAPACITY (GPM) AT VARIOUS PRESSURE*						
		2 PSI	4 PSI	6 PSI	8 PSI	10 PSI	15 PSI	20 PSI
25660-1.5	CP25670-1.5-NY	1.4	1.9	2.3	2.6	2.9	3.4	4.0
25660-3.0	CP25670-3.0-NYB	2.0	2.7	3.2	3.6	4.1	4.9	5.6
25660-4.0	CP25670-4.0-NY	2.3	3.1	3.7	4.3	4.7	5.6	6.4

*Pressure measured at spray nozzle.



25660 TeeJet Lawn Spray Gun

25990 Swivel

Allows operator to concentrate on application without hose interference. 3/4" (M) NPT connection with 1/2" hose shank. Maximum pressure 150 PSI (10 bar).

25657-NYB Adapter

Replaces shower nozzle to allow extension wand or standard TeeJet tip to be attached directly to lawn spray gun. 3/4" (F) GHT inlet with 1/16"-16 TeeJet thread outlet. Maximum pressure 150 PSI (10 bar). See page 134 for adjustable ConeJet® nozzles.

22665 Extension Wand

For low volume and spot spraying applications. Available in both 15" and 24" (38 cm and 61 cm) lengths, the extension fits on 25657-NYB adapter. Maximum pressure 150 PSI (10 bar).

CP22673-PP & CP22664-PP Adapters

Used for attaching standard TeeJet tips or adjustable ConeJet nozzles. See page 134 for adjustable ConeJet nozzles.



PW4000A

The model PW4000A GunJet is a durable high-pressure spray gun that offers comfort and control. Trigger locks into an off position to prevent accidental discharge. The PW4000A operates at up to 4,000 PSI (275 bar) and provides flow rates up to 10 GPM (38 l/min). Liquid temperatures up to 300°F (150°C). Available with 1/4" or 3/8" NPT or BSPT inlet and outlet connections.

PW4000AS

The model PW4000AS has the same features as PW4000A except available with a 3/8" NPT or BSPT swivel inlet.

How to order:

Specify model number.

Example: (B)PW4000A –
 3/8" inlet and 1/4" outlet
 (B)PW4000A-1/4x1/4 –
 1/4" inlet and outlet
 (B)PW4000A-3/8x3/8 –
 3/8" inlet and outlet

(B) = BSPT



AA30A

Maximum pressure rating of 1,500 PSI (105 bar) with 5 GPM (19 l/min), 200°F (93°C) and 1/4" (F) NPT or BSPT inlet thread. Materials including Nylon handles and trigger guards, forged brass valve bodies, Buna-N or Viton® stem seals, Teflon® valve seats and stainless steel working parts mean long, productive equipment life.

How to order:

Specify model number.

Example: AA(B)30A-1/4
 (B) = BSPT

See page 135 for extensions.



AA23L-7676

The AA23L-7676 GunJet spray gun (shown above) is also available without extension as GunJet spray gun AA23L. Flow rates up to 5 GPM (19 l/min). Maximum operating pressure of 250 PSI (17 bar). Inlet 1/4" NPS (M) thread. Strong aluminum alloy body. When used with extension, the valve stem extends through the entire extension length for drip-free shutoff immediately behind the spray tip. Accommodates all interchangeable TeeJet® spray tips.

GUNJET NUMBER	EXTENSION LENGTH
AA23L	Without Extension
AA23L-7676-8	8" (203 mm)
AA23L-7676-18	18" (457 mm)
AA23L-7676-24	24" (610 mm)
AA23L-7676-36	36" (914 mm)
AA23L-7676-48	48" (1,219 mm)

How to order:

Specify model number.

Example: AA23L

AA30L-PP

This new version of the standard AA30L GunJet spray gun is constructed of polypropylene for excellent corrosion resistance. The maximum pressure rating is 150 PSI (10 bar) with flow rates up to 5 GPM (19 l/min). Liquid inlet connection available in 1/4" (F) NPT or BSPT. Wetted parts are polypropylene, stainless steel and Viton.

How to order:

Specify model number.

Example: AA(B)30L-PP
 (B) = BSPT



AA30L-22425

The AA30L-22425 GunJet spray gun (shown above) is also available without extension as GunJet spray gun AA30L. Flow rates up to 5 GPM (19 l/min). Maximum operating pressure of 250 PSI (17 bar). Outlet connection is 1/8"-16 TeeJet® thread. Body and trigger molded of tough Nylon. When used with extension, the valve stem extends through the entire extension length for drip-free shutoff immediately behind the spray tip. Accommodates all interchangeable TeeJet spray tips.

GUNJET NUMBER	EXTENSION LENGTH
AA(B)30L-1/4	Without Extension
AA(B)30L-22425-8	8" (203 mm)
AA(B)30L-22425-18	18" (457 mm)
AA(B)30L-22425-24	24" (610 mm)
AA(B)30L-22425-36	36" (914 mm)
AA(B)30L-22425-48	48" (1,219 mm)

How to order:

Specify model number.

Example: AA(B)30L-1/4

(B) = BSPT





TriggerJet[®] Spray Guns

38720-PPB-X*

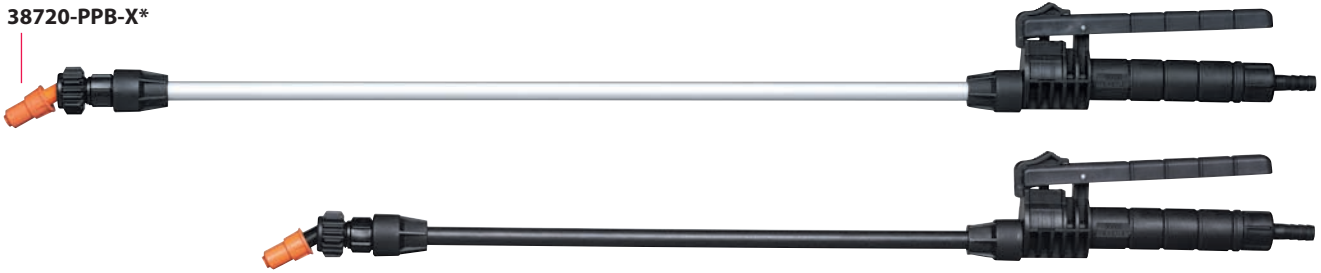



Model 50800

The 50800 TriggerJet spray gun is a lightweight spray gun designed for use with backpack, canister or other low-pressure sprayers. The TriggerJet is made of molded polypropylene for excellent chemical resistance and durability.

Features:

- Available with 15" (381 mm) polypropylene or 21" (533 mm) aluminum extension wand.
- Available with 38720-PPB-X18 or X26 adjustable ConeJet[®] tips with a 30° offset.
- Trigger lock permits locking gun in an open position for continuous flow.
- Maximum operating pressure of 100 PSI (7 bar).
- 1/4" or 3/8" hose shank connection.
- Approximate max. hose O.D.— 1/2" (13 mm).
- Polypropylene strainer located inside handle to prevent tip clogging.

MODEL NUMBER	DESCRIPTION	INLET CONNECTION	TIP NUMBER
50800-15-PP-300	15" (381 mm) Polypropylene Extension	1/4" Hose Barb Inlet	 38720-PPB-X18
50800-15-PP-406		3/8" Hose Barb Inlet	
50800-21-AL-300	21" (533 mm) Aluminum Extension	1/4" Hose Barb Inlet	
50800-21-AL-406		3/8" Hose Barb Inlet	
50800-15-PP-300-X26	15" (381 mm) Polypropylene Extension	1/4" Hose Barb Inlet	 38720-PPB-X26
50800-15-PP-406-X26		3/8" Hose Barb Inlet	
50800-21-AL-300-X26	21" (533 mm) Aluminum Extension	1/4" Hose Barb Inlet	
50800-21-AL-406-X26		3/8" Hose Barb Inlet	

50800 TriggerJet Less Extension and Tip Feature:

- Can be fitted with any standard TeeJet[®] tip.

MODEL NUMBER	DESCRIPTION	INLET CONNECTION
50800-PP-300	TriggerJet, Less Extension	1/4" Hose Barb Inlet
50800-PP-406	TriggerJet, Less Extension	3/8" Hose Barb Inlet





Model 22670

The 22670 TriggerJet spray gun kit combines the 22650 TriggerJet spray gun with an extension wand and the items listed in Features. Maximum pressure rating is 150 PSI (10 bar).

Features:

- 22650 TriggerJet spray gun with choice of 1/4" or 3/8" hose shank and a 1/4" NPT or BSPT (F) thread inlet connection.
- Trigger lock permits locking gun in an open position for continuous flow (optional).
- 22665 extension wand with choice of 15" (381 mm) or 24" (610 mm) lengths.
- 38720-PPB-X8 adjustable ConeJet® spray tip with Viton® O-ring.
- CP22673-PP 45° and CP22664-PP straight adapters (other capacities available).
- Accepts all standard TeeJet spray tips and tip strainers.

MODEL NUMBER	EXTENSION LENGTH	INLET CONNECTION	TIP NUMBER
(B)22670-PP-15-1/4	15" (38 cm)	1/4" (F)	 38720-PPB-X8 (Standard nozzle shipped with TriggerJet)
22670-PP-15-300	15" (38 cm)	1/4" Hose Shank	
22670-PP-15-406	15" (38 cm)	3/8" Hose Shank	
(B)22670-PP-24-1/4	24" (61 cm)	1/4" (F)	
22670-PP-24-300	24" (61 cm)	1/4" Hose Shank	
22670-PP-24-406	24" (61 cm)	3/8" Hose Shank	

(B)=BSPT

How to order:

Specify model number.
 Example: (B)22670-PP-15-1/4
 Reference page 134 for additional spray tip information.



Model 22650

The 22650 TriggerJet spray gun is a lightweight spray gun designed for use with backpack, canister or other low-pressure sprayers. The TriggerJet is made of molded polypropylene for excellent chemical resistance and durability.

Features:

- Choice of 1/4" or 3/8" hose shank and 1/4" NPT or BSPT (F) thread inlet connection.
- Replaceable diaphragm made of Viton.
- Trigger lock permits locking gun in an open position for continuous flow (optional).
- Maximum operating pressure of 150 PSI (10 bar).
- Accepts all standard TeeJet spray tips and tip strainers.

MODEL NUMBER	EXTENSION LENGTH	INLET CONNECTION	TIP NUMBER
(B)22650-PP-1/4	NONE	1/4" (F)	NONE
22650-PP-300		1/4" Hose Shank	
22650-PP-406		3/8" Hose Shank	

(B)=BSPT

How to order:

Specify model number.
 Example: (B)22650-PP-1/4
 Reference page 134 for additional spray tip information.



ConeJet® Adjustable Spray Tips

38720-PP

- Provides adjustable spray from solid stream to a hollow cone pattern.
- Made of polypropylene material for excellent chemical resistance.
- Fits any 1/16"–16 TeeJet® male thread bodies.
- 30° offset from horizontal incorporated into main tip body.



ADJUSTABLE CONEJET TIP NUMBER	PERFORMANCE	LIQUID PRESSURE IN PSI									
		20 PSI		30 PSI		40 PSI		60 PSI		100 PSI	
		SETTING		SETTING		SETTING		SETTING		SETTING	
		A	B	A	B	A	B	A	B	A	B
38720-PPB-X8	Capacity – GPM	0.097	0.33	0.12	0.40	0.13	0.47	0.16	0.57	0.21	0.74
	Spray Angle	66°	—	71°	—	74°	—	77°	—	80°	—
	Max. Throw – Ft.	3	34	3	37	3	38	3	38	4	38
38720-PPB-X12	Capacity – GPM	0.15	0.49	0.18	0.60	0.20	0.69	0.24	0.84	0.31	1.1
	Spray Angle	71°	—	75°	—	77°	—	78°	—	80°	—
	Max. Throw – Ft.	3.5	36	4	39	4	40	4	41	4	41
38720-PPB-X18	Capacity – GPM	0.20	0.68	0.24	0.81	0.28	0.92	0.34	1.1	0.42	1.4
	Spray Angle	61°	—	68°	—	80°	—	80°	—	80°	—
	Max. Throw – Ft.	4	38	4	41	4	42	4	42	6	42
38720-PPB-X26	Capacity – GPM	0.31	0.89	0.38	1.1	0.43	1.2	0.53	1.5	0.68	1.9
	Spray Angle	77°	—	82°	—	84°	—	86°	—	86°	—
	Max. Throw – Ft.	4	34	4.5	37	5	38	5.5	39	6	40

5500

Knurled body of tip rotates through a half turn to provide spray selection from wide angle, finely atomized cone spray to a straight stream spray. Tip settings "A" and "B" represent two extreme points of rotation in tip adjustment. Other sizes available.



5500-PP

The 5500 adjustable ConeJet tip is also available in a polypropylene version. The polypropylene tip has the same performance characteristics as the brass tip and provides excellent chemical resistance. This tip's light weight makes it well-suited for use on handheld and backpack type sprayers.

O-Ring: EPDM is standard, Viton® is optional.

TIP SETTING "A"
CONE SPRAY PATTERN

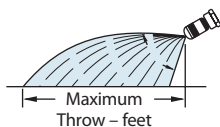

TIP SETTING "B"
STRAIGHT STREAM SPRAY PATTERN



ADJUSTABLE CONEJET TIP NUMBER	PERFORMANCE	LIQUID PRESSURE IN PSI											
		20 PSI		30 PSI		40 PSI		60 PSI		100 PSI		150 PSI	
		SETTING		SETTING		SETTING		SETTING		SETTING		SETTING	
		A	B	A	B	A	B	A	B	A	B	A	B
5500-X1	Capacity – GPM	—	.049	.015	.061	.017	.07	.02	.086	.025	.11	.028	.14
	Spray Angle	—	—	38°	—	54°	—	71°	—	80°	—	83°	—
	Max. Throw – Ft.	—	19	1	22	1.5	24	1.5	26	1.5	26	1.5	26
5500-X2	Capacity – GPM	.025	.091	.03	.11	.033	.13	.04	.16	.05	.20	.058	.25
	Spray Angle	40°	—	60°	—	68°	—	75°	—	80°	—	83°	—
	Max. Throw – Ft.	1.5	23	1.5	26	2	27	2	28	2	28	2	28
5500-X3	Capacity – GPM	.037	.13	.045	.17	.05	.19	.058	.23	.073	.30	.088	.37
	Spray Angle	57°	—	68°	—	72°	—	76°	—	80°	—	82°	—
	Max. Throw – Ft.	2	27	2	30	2	31	2	31	3	31	3	31
5500-PPB-X3	Capacity – GPM	.05	.18	.058	.22	.067	.25	.08	.31	.10	.40	.12	.49
	Spray Angle	61°	—	70°	—	73°	—	77°	—	80°	—	81°	—
	Max. Throw – Ft.	2.5	30	2.5	33	3	34	3	34	3	34	3	34
5500-X4	Capacity – GPM	.061	.21	.076	.26	.082	.30	.10	.37	.13	.48	.15	.58
	Spray Angle	61°	—	70°	—	74°	—	77°	—	80°	—	81°	—
	Max. Throw – Ft.	2.5	31	2.5	34	3	35	3	35	3	35	3	35
5500-PPB-X4	Capacity – GPM	.073	.26	.087	.32	.10	.37	.12	.45	.15	.58	.19	.71
	Spray Angle	65°	—	71°	—	74°	—	77°	—	80°	—	80°	—
	Max. Throw – Ft.	2.5	32	3	35	3	36	3.5	36	3.5	36	3.4	36
5500-X5	Capacity – GPM	.097	.33	.12	.40	.13	.47	.16	.57	.21	.74	.25	.90
	Spray Angle	66°	—	71°	—	74°	—	77°	—	80°	—	80°	—
	Max. Throw – Ft.	3	34	3	37	3	38	3	38	4	38	4	38
5500-PPB-X5	Capacity – GPM	.12	.42	.15	.52	.17	.60	.21	.73	.26	.94	.31	1.2
	Spray Angle	68°	—	72°	—	75°	—	78°	—	80°	—	80°	—
	Max. Throw – Ft.	3	35	3.5	38	3.5	39	4	40	4	40	4	40
5500-X6	Capacity – GPM	.15	.49	.18	.60	.20	.69	.24	.84	.31	1.1	.38	1.3
	Spray Angle	69°	—	73°	—	76°	—	78°	—	80°	—	80°	—
	Max. Throw – Ft.	3.5	36	4	39	4	40	4	41	4	41	4	41
5500-PPB-X6	Capacity – GPM	.17	.55	.20	.67	.23	.78	.29	.95	.37	1.2	.45	1.5
	Spray Angle	70°	—	74°	—	76°	—	78°	—	80°	—	80°	—
	Max. Throw – Ft.	3.5	37	4	40	4	41	4	41	4.5	41	4.5	41
5500-X7	Capacity – GPM	.21	.69	.26	.84	.30	.97	.37	1.2	.47	1.5	.58	1.9
	Spray Angle	71°	—	75°	—	77°	—	78°	—	80°	—	79°	—
	Max. Throw – Ft.	4	38	4	41	4	42	4	42	5	42	5	42
5500-PPB-X7	Capacity – GPM	.26	.83	.32	1.0	.37	1.2	.45	1.4	.58	1.9	.70	2.3
	Spray Angle	71°	—	75°	—	78°	—	79°	—	80°	—	78°	—
	Max. Throw – Ft.	4	39	4.5	41	5	42	5	42	5	42	5	42
5500-X8	Capacity – GPM	.31	.98	.37	1.2	.43	1.4	.53	1.7	.68	2.2	.83	2.7
	Spray Angle	72°	—	76°	—	78°	—	79°	—	80°	—	78°	—
	Max. Throw – Ft.	4.5	40	5	42	5	43	5.5	43	5.5	43	5.5	43

Above data is based on spraying water from a height of about 2½ feet with tip tilted about as shown at left for each setting.



Top quality hand valves for use with spray nozzles, extensions and handles to suit your application needs. Hand valve assemblies may be made from parts shown on this page. The “typical assembly” shown at right includes 4727 handle, 4688 valve, 4673-8 curved extension with swivel body, TeeJet cap and flat spray tip.



Typical Shutoff Valve Assembly

AA31 for pressures up to 500 PSI (35 bar)

Comfortable palm fitting gun. For use with any TeeJet spray tip. 1/4" NPS (M) inlet connection.

Forged brass body and nickel-plated steel trigger. Teflon® valve seat and packing, stainless steel valve stem. Weight 12 oz. (0.34 kg). Also supplied as 31-1/4F with 1/4" NPT (F) inlet connection.



AA31

Valves



4688

6466

4688 Trigger Valve with trigger lock. Max. flow rate 2 GPM (7.6 l/min), max. pressure of 250 PSI (17 bar). 1/4" NPT (F) inlet connection, 1/16"-16 (M) outlet connection. Use with TeeJet and ConeJet® tips, adjustable ConeJet tips or MulteeJet® tips. Brass material.

6466 Trigger Valve, same as 4688, less trigger lock, with extra long trigger. Brass material.



6104

6590

6104 Trigger Valve with trigger lock. Same as 4688 except with 1/4" NPT (F) inlet and outlet connections. Brass material.

6590 Trigger Valve, same as 6104, less trigger lock, with extra long trigger. Brass material.



13212

Garden Hose Adapter for 36 Valve

13212 Adapter, 3/8" NPT (M) outlet, 3/4" garden hose thread inlet for use with 3/8" 36 valve. Brass material.

Valve Handles

Choice of valve handles — for above valves



4727



4754



4725

Outlet connections are 1/4" NPT (M) to fit 1/4" NPT (F) inlets of all valves shown. Choice of types for every need.

(B)4727 Sure Grip Handle, brass, rubber-covered, 1/4" NPS (M) or BSPT hose inlet connection.

4754 Sure Grip Handle, brass, rubber-covered, 3/4" garden hose thread (F) inlet connection.

4725 Handle, made of 1/8" brass pipe with bushing. Slip hose over pipe to form handle.

Extensions for Valves and Spray Guns



9527

High-Pressure Curved Extensions

9527—for pressures to 1,000 PSI (70 bar). Fits models 23H and 31 GunJet spray guns.

For Pressures up to 1,000 PSI

EXTENSION TYPE AND NUMBER	EXTENSION LENGTH IN INCHES (millimeters)
9527-8	8" (203 mm)
9527-18	18" (457 mm)
9527-24	24" (610 mm)
9527-36	36" (914 mm)
9527-48	48" (1,219 mm)



4673

7715

Straight and Curved Extensions

4673 and 6671—for pressures to 125 PSI (9 bar). 7715—for pressures to 250 PSI (17 bar). Fits models 23L and 31 GunJet® spray guns and trigger valves.



22665-PP

TriggerJet® Extension

22665-PP is for use with 22650-PP TriggerJet spray gun. Maximum pressure rating of 150 PSI (10 bar). Available in 15" and 24" (38 and 61 cm) lengths.

STRAIGHT WITH FIXED BODY	CURVED WITH SWIVEL BODY	CURVED WITH FIXED BODY	EXTENSION LENGTH
7715-8	4673-8	6671-8	8" (203 mm)
7715-18	4673-18	6671-18	18" (457 mm)
7715-24	4673-24	6671-24	24" (610 mm)
7715-30	4673-30	6671-30	30" (762 mm)
7715-36	4673-36	6671-36	36" (914 mm)
7715-48	4673-48	6671-48	48" (1,219 mm)

$$A = \frac{B+C}{D}$$

Technical Information

Universal Application Rate Chart for 15" Tip Spacing

TIP CAPACITY	LIQUID PRESSURE IN PSI	CAPACITY 1 NOZZLE IN GPM	CAPACITY 1 NOZZLE IN OZ./MIN.	GALLONS PER ACRE - 15" NOZZLE SPACING											
				4 MPH	5 MPH	6 MPH	7 MPH	8 MPH	10 MPH	12 MPH	14 MPH	16 MPH	18 MPH	20 MPH	22 MPH
01	15	0.061	7.8	6.0	4.8	4.0	3.5	3.0	2.4	2.0	1.7	1.5	1.3	1.2	1.1
	20	0.071	9.1	7.0	5.6	4.7	4.0	3.5	2.8	2.3	2.0	1.8	1.6	1.4	1.3
	30	0.087	11	8.6	6.9	5.7	4.9	4.3	3.4	2.9	2.5	2.2	1.9	1.7	1.6
	40	0.10	13	9.9	7.9	6.6	5.7	5.0	4.0	3.3	2.8	2.5	2.2	2.0	1.8
	50	0.11	14	10.9	8.7	7.3	6.2	5.4	4.4	3.6	3.1	2.7	2.4	2.2	2.0
	60	0.12	15	11.9	9.5	7.9	6.8	5.9	4.8	4.0	3.4	3.0	2.6	2.4	2.2
	75	0.14	18	13.9	11.1	9.2	7.9	6.9	5.5	4.6	4.0	3.5	3.1	2.8	2.5
90	0.15	19	14.9	11.9	9.9	8.5	7.4	5.9	5.0	4.2	3.7	3.3	3.0	2.7	
015	15	0.092	12	9.1	7.3	6.1	5.2	4.6	3.6	3.0	2.6	2.3	2.0	1.8	1.7
	20	0.11	14	10.9	8.7	7.3	6.2	5.4	4.4	3.6	3.1	2.7	2.4	2.2	2.0
	30	0.13	17	12.9	10.3	8.6	7.4	6.4	5.1	4.3	3.7	3.2	2.9	2.6	2.3
	40	0.15	19	14.9	11.9	9.9	8.5	7.4	5.9	5.0	4.2	3.7	3.3	3.0	2.7
	50	0.17	22	16.8	13.5	11.2	9.6	8.4	6.7	5.6	4.8	4.2	3.7	3.4	3.1
	60	0.18	23	17.8	14.3	11.9	10.2	8.9	7.1	5.9	5.1	4.5	4.0	3.6	3.2
	75	0.21	27	21	16.6	13.9	11.9	10.4	8.3	6.9	5.9	5.2	4.6	4.2	3.8
90	0.23	29	23	18.2	15.2	13.0	11.4	9.1	7.6	6.5	5.7	5.1	4.6	4.1	
02	15	0.12	15	11.9	9.5	7.9	6.8	5.9	4.8	4.0	3.4	3.0	2.6	2.4	2.2
	20	0.14	18	13.9	11.1	9.2	7.9	6.9	5.5	4.6	4.0	3.5	3.1	2.8	2.5
	30	0.17	22	16.8	13.5	11.2	9.6	8.4	6.7	5.6	4.8	4.2	3.7	3.4	3.1
	40	0.20	26	19.8	15.8	13.2	11.3	9.9	7.9	6.6	5.7	5.0	4.4	4.0	3.6
	50	0.22	28	22	17.4	14.5	12.4	10.9	8.7	7.3	6.2	5.4	4.8	4.4	4.0
	60	0.24	31	24	19.0	15.8	13.6	11.9	9.5	7.9	6.8	5.9	5.3	4.8	4.3
	75	0.27	35	27	21	17.8	15.3	13.4	10.7	8.9	7.6	6.7	5.9	5.3	4.9
90	0.30	38	30	24	19.8	17.0	14.9	11.9	9.9	8.5	7.4	6.6	5.9	5.4	
025	15	0.15	19	14.9	11.9	9.9	8.5	7.4	5.9	5.0	4.2	3.7	3.3	3.0	2.7
	20	0.18	23	17.8	14.3	11.9	10.2	8.9	7.1	5.9	5.1	4.5	4.0	3.6	3.2
	30	0.22	28	22	17.4	14.5	12.4	10.9	8.7	7.3	6.2	5.4	4.8	4.4	4.0
	40	0.25	32	25	19.8	16.5	14.1	12.4	9.9	8.3	7.1	6.2	5.5	5.0	4.5
	50	0.28	36	28	22	18.5	15.8	13.9	11.1	9.2	7.9	6.9	6.2	5.5	5.0
	60	0.31	40	31	25	20	17.5	15.3	12.3	10.2	8.8	7.7	6.8	6.1	5.6
	75	0.34	44	34	27	22	19.2	16.8	13.5	11.2	9.6	8.4	7.5	6.7	6.1
90	0.38	49	38	30	25	21	18.8	15.0	12.5	10.7	9.4	8.4	7.5	6.8	
03	15	0.18	23	17.8	14.3	11.9	10.2	8.9	7.1	5.9	5.1	4.5	4.0	3.6	3.2
	20	0.21	27	21	16.6	13.9	11.9	10.4	8.3	6.9	5.9	5.2	4.6	4.2	3.8
	30	0.26	33	26	21	17.2	14.7	12.9	10.3	8.6	7.4	6.4	5.7	5.1	4.7
	40	0.30	38	30	24	19.8	17.0	14.9	11.9	9.9	8.5	7.4	6.6	5.9	5.4
	50	0.34	44	34	27	22	19.2	16.8	13.5	11.2	9.6	8.4	7.5	6.7	6.1
	60	0.37	47	37	29	24	21	18.3	14.7	12.2	10.5	9.2	8.1	7.3	6.7
	75	0.41	52	41	32	27	23	20	16.2	13.5	11.6	10.1	9.0	8.1	7.4
90	0.45	58	45	36	30	25	22	17.8	14.9	12.7	11.1	9.9	8.9	8.1	
04	15	0.24	31	24	19.0	15.8	13.6	11.9	9.5	7.9	6.8	5.9	5.3	4.8	4.3
	20	0.28	36	28	22	18.5	15.8	13.9	11.1	9.2	7.9	6.9	6.2	5.5	5.0
	30	0.35	45	35	28	23	19.8	17.3	13.9	11.6	9.9	8.7	7.7	6.9	6.3
	40	0.40	51	40	32	26	23	19.8	15.8	13.2	11.3	9.9	8.8	7.9	7.2
	50	0.45	58	45	36	30	25	22	17.8	14.9	12.7	11.1	9.9	8.9	8.1
	60	0.49	63	49	39	32	28	24	19.4	16.2	13.9	12.1	10.8	9.7	8.8
	75	0.55	70	54	44	36	31	27	22	18.2	15.6	13.6	12.1	10.9	9.9
90	0.60	77	59	48	40	34	30	24	19.8	17.0	14.9	13.2	11.9	10.8	
05	15	0.31	40	31	25	20	17.5	15.3	12.3	10.2	8.8	7.7	6.8	6.1	5.6
	20	0.35	45	35	28	23	19.8	17.3	13.9	11.6	9.9	8.7	7.7	6.9	6.3
	30	0.43	55	43	34	28	24	21	17.0	14.2	12.2	10.6	9.5	8.5	7.7
	40	0.50	64	50	40	33	28	25	19.8	16.5	14.1	12.4	11.0	9.9	9.0
	50	0.56	72	55	44	37	32	28	22	18.5	15.8	13.9	12.3	11.1	10.1
	60	0.61	78	60	48	40	35	30	24	20	17.3	15.1	13.4	12.1	11.0
	75	0.68	87	67	54	45	38	34	27	22	19.2	16.8	15.0	13.5	12.2
90	0.75	96	74	59	50	42	37	30	25	21	18.6	16.5	14.9	13.5	
06	15	0.37	47	37	29	24	21	18.3	14.7	12.2	10.5	9.2	8.1	7.3	6.7
	20	0.42	54	42	33	28	24	21	16.6	13.9	11.9	10.4	9.2	8.3	7.6
	30	0.52	67	51	41	34	29	26	21	17.2	14.7	12.9	11.4	10.3	9.4
	40	0.60	77	59	48	40	34	30	24	19.8	17.0	14.9	13.2	11.9	10.8
	50	0.67	86	66	53	44	38	33	27	22	19.0	16.6	14.7	13.3	12.1
	60	0.73	93	72	58	48	41	36	29	24	21	18.1	16.1	14.5	13.1
	75	0.82	105	81	65	54	46	41	32	27	23	20	18.0	16.2	14.8
90	0.90	115	89	71	59	51	45	36	30	25	22	19.8	17.8	16.2	
08	15	0.49	63	49	39	32	28	24	19.4	16.2	13.9	12.1	10.8	9.7	8.8
	20	0.57	73	56	45	38	32	28	23	18.8	16.1	14.1	12.5	11.3	10.3
	30	0.69	88	68	55	46	39	34	27	23	19.5	17.1	15.2	13.7	12.4
	40	0.80	102	79	63	53	45	40	32	26	23	19.8	17.6	15.8	14.4
	50	0.89	114	88	70	59	50	44	35	29	25	22	19.6	17.6	16.0
	60	0.98	125	97	78	65	55	49	39	32	28	24	22	19.4	17.6
	75	1.10	141	109	87	73	62	54	44	36	31	27	24	22	19.8
90	1.20	154	119	95	79	68	59	48	40	34	30	26	24	22	
10	15	0.61	78	60	48	40	35	30	24	20	17.3	15.1	13.4	12.1	11.0
	20	0.71	91	70	56	47	40	35	28	23	20	17.6	15.6	14.1	12.8
	30	0.87	111	86	69	57	49	43	34	29	25	22	19.1	17.2	15.7
	40	1.00	128	99	79	66	57	50	40	33	28	25	22	19.8	18.0
	50	1.12	143	111	89	74	63	55	44	37	32	28	25	22	20
	60	1.22	156	121	97	81	69	60	48	40	35	30	27	24	22
	75	1.37	175	136	109	90	78	68	54	45	39	34	30	27	25
90	1.50	192	149	119	99	85	74	59	50	42	37	33	30	27	
15	15	0.92	118	91	73	61	52	46	36	30	26	23	20	18.2	16.6
	20	1.06	136	105	84	70	60	52	42	35	30	26	23	21	19.1
	30	1.30	166	129	103	86	74	64	51	43	37	32	29	26	23
	40	1.50	192	149	119	99	85	74	59	50	42	37	33	30	27
	50	1.68	215	166	133	111	95	83	67	55	48	42	37	33	30
	60	1.84	236	182	146	121	104	91	73	61	52	46	40	36	33
	75	2.05	262	203	162	135	116	101	81	68	58	51	45	41	37
90	2.25	288	223	178	149	127	111	89	74	64	56	50	45	41	
20	15	1.22	156	121	97	81	69	60	48	40	35	30	27	24	22
	20	1.41	180	140	112	93	80	70	56	47	40	35	31	28	25
	30	1.73	221	171	137	114	98	86	69	57	49	43	38	34	31
	40	2.00	256	198	158	132	113	99	79	66	57	50	44	40	36
	50	2.24	287	222	177	148	127	111	89	74	63	55	49	44	40
	60	2.45	314	243	194	162	139	121	97	81	69	61	54	49	44
	75	2.74	351	271	217	181	155	136	109	90	78	68	60	54	49
90	3.00	384	297	238	198	170	149	119	99	85	74	66	59	54	

Note: Always double check your application rates. Tabulations are based on spraying water at 70°F (21°C).

$$A = \frac{B+C}{D}$$

Technical Information

Universal Application Rate Chart for 20" Tip Spacing

TIP CAPACITY	LIQUID PRESSURE IN PSI	CAPACITY 1 NOZZLE IN GPM	CAPACITY 1 NOZZLE IN OZ./MIN.	GALLONS PER ACRE - 20" NOZZLE SPACING											
				4 MPH	5 MPH	6 MPH	7 MPH	8 MPH	10 MPH	12 MPH	14 MPH	16 MPH	18 MPH	20 MPH	22 MPH
01	15	0.061	7.8	4.5	3.6	3.0	2.6	2.3	1.8	1.5	1.3	1.1	1.0	0.91	0.82
	20	0.071	9.1	5.3	4.2	3.5	3.0	2.6	2.1	1.8	1.5	1.3	1.2	1.1	0.96
	30	0.087	11	6.5	5.2	4.3	3.7	3.2	2.6	2.2	1.8	1.6	1.4	1.3	1.2
	40	0.10	13	7.4	5.9	5.0	4.2	3.7	3.0	2.5	2.1	1.9	1.7	1.5	1.4
	50	0.11	14	8.2	6.5	5.4	4.7	4.1	3.3	2.7	2.3	2.0	1.8	1.6	1.5
	60	0.12	15	8.9	7.1	5.9	5.1	4.5	3.6	3.0	2.5	2.2	2.0	1.8	1.6
	75	0.14	18	10.4	8.3	6.9	5.9	5.2	4.2	3.5	3.0	2.6	2.3	2.1	1.9
90	0.15	19	11.1	8.9	7.4	6.4	5.6	4.5	3.7	3.2	2.8	2.5	2.2	2.0	
015	15	0.092	12	6.8	5.5	4.6	3.9	3.4	2.7	2.3	2.0	1.7	1.5	1.4	1.2
	20	0.11	14	8.2	6.5	5.4	4.7	4.1	3.3	2.7	2.3	2.0	1.8	1.6	1.5
	30	0.13	17	9.7	7.7	6.4	5.5	4.8	3.9	3.2	2.8	2.4	2.1	1.9	1.8
	40	0.15	19	11.1	8.9	7.4	6.4	5.6	4.5	3.7	3.2	2.8	2.5	2.2	2.0
	50	0.17	22	12.6	10.1	8.4	7.2	6.3	5.0	4.2	3.6	3.2	2.8	2.5	2.3
	60	0.18	23	13.4	10.7	8.9	7.6	6.7	5.3	4.5	3.8	3.3	3.0	2.7	2.4
	75	0.21	27	15.6	12.5	10.4	8.9	7.8	6.2	5.2	4.5	3.9	3.5	3.1	2.8
90	0.23	29	17.1	13.7	11.4	9.8	8.5	6.8	5.7	4.9	4.3	3.8	3.4	3.1	
02	15	0.12	15	8.9	7.1	5.9	5.1	4.5	3.6	3.0	2.5	2.2	2.0	1.8	1.6
	20	0.14	18	10.4	8.3	6.9	5.9	5.2	4.2	3.5	3.0	2.6	2.3	2.1	1.9
	30	0.17	22	12.6	10.1	8.4	7.2	6.3	5.0	4.2	3.6	3.2	2.8	2.5	2.3
	40	0.20	26	14.9	11.9	9.9	8.5	7.4	5.9	5.0	4.2	3.7	3.3	3.0	2.7
	50	0.22	28	16.3	13.1	10.9	9.3	8.2	6.5	5.4	4.7	4.1	3.6	3.3	3.0
	60	0.24	31	17.8	14.3	11.9	10.2	8.9	7.1	5.9	5.1	4.5	4.0	3.6	3.2
	75	0.27	35	20	16.0	13.4	11.5	10.0	8.0	6.7	5.7	5.0	4.5	4.0	3.6
90	0.30	38	22	17.8	14.9	12.7	11.1	8.9	7.4	6.4	5.6	5.0	4.5	4.1	
025	15	0.15	19	11.1	8.9	7.4	6.4	5.6	4.5	3.7	3.2	2.8	2.5	2.2	2.0
	20	0.18	23	13.4	10.7	8.9	7.6	6.7	5.3	4.5	3.8	3.3	3.0	2.7	2.4
	30	0.22	28	16.3	13.1	10.9	9.3	8.2	6.5	5.4	4.7	4.1	3.6	3.3	3.0
	40	0.25	32	18.6	14.9	12.4	10.6	9.3	7.4	6.2	5.3	4.6	4.1	3.7	3.4
	50	0.28	36	21	16.6	13.9	11.9	10.4	8.3	6.9	5.9	5.2	4.6	4.2	3.8
	60	0.31	40	23	18.4	15.3	13.2	11.5	9.2	7.7	6.6	5.8	5.1	4.6	4.2
	75	0.34	44	25	20	16.8	14.4	12.6	10.1	8.4	7.2	6.3	5.6	5.0	4.6
90	0.38	49	28	23	18.8	16.1	14.1	11.3	9.4	8.1	7.1	6.3	5.6	5.1	
03	15	0.18	23	13.4	10.7	8.9	7.6	6.7	5.3	4.5	3.8	3.3	3.0	2.7	2.4
	20	0.21	27	15.6	12.5	10.4	8.9	7.8	6.2	5.2	4.5	3.9	3.5	3.1	2.8
	30	0.26	33	19.3	15.4	12.9	11.0	9.7	7.7	6.4	5.5	4.8	4.3	3.9	3.5
	40	0.30	38	22	17.8	14.9	12.7	11.1	8.9	7.4	6.4	5.6	5.0	4.5	4.1
	50	0.34	44	25	20	16.8	14.4	12.6	10.1	8.4	7.2	6.3	5.6	5.0	4.6
	60	0.37	47	27	22	18.3	15.7	13.7	11.0	9.2	7.8	6.9	6.1	5.5	5.0
	75	0.41	52	30	24	20	17.4	15.2	12.2	10.1	8.7	7.6	6.8	6.1	5.5
90	0.45	58	33	27	22	19.1	16.7	13.4	11.1	9.5	8.4	7.4	6.7	6.1	
04	15	0.24	31	17.8	14.3	11.9	10.2	8.9	7.1	5.9	5.1	4.5	4.0	3.6	3.2
	20	0.28	36	21	16.6	13.9	11.9	10.4	8.3	6.9	5.9	5.2	4.6	4.2	3.8
	30	0.35	45	26	21	17.3	14.9	13.0	10.4	8.7	7.4	6.5	5.8	5.2	4.7
	40	0.40	51	30	24	19.8	17.0	14.9	11.9	9.9	8.5	7.4	6.6	5.9	5.4
	50	0.45	58	33	27	22	19.1	16.7	13.4	11.1	9.5	8.4	7.4	6.7	6.1
	60	0.49	63	36	29	24	21	18.2	14.6	12.1	10.4	9.1	8.1	7.3	6.6
	75	0.55	70	41	33	27	23	20	16.3	13.6	11.7	10.2	9.1	8.2	7.4
90	0.60	77	45	36	30	25	22	17.8	14.9	12.7	11.1	9.9	8.9	8.1	
05	15	0.31	40	23	18.4	15.3	13.2	11.5	9.2	7.7	6.6	5.8	5.1	4.6	4.2
	20	0.35	45	26	21	17.3	14.9	13.0	10.4	8.7	7.4	6.5	5.8	5.2	4.7
	30	0.43	55	32	26	21	18.2	16.0	12.8	10.6	9.1	8.0	7.1	6.4	5.8
	40	0.50	64	37	30	25	21	18.6	14.9	12.4	10.6	9.3	8.3	7.4	6.8
	50	0.56	72	42	33	28	24	21	16.6	13.9	11.9	10.4	9.2	8.3	7.6
	60	0.61	78	45	36	30	26	23	18.1	15.1	12.9	11.3	10.1	9.1	8.2
	75	0.68	87	50	40	34	29	25	20	16.8	14.4	12.6	11.2	10.1	9.2
90	0.75	96	56	45	37	32	28	22	18.6	15.9	13.9	12.4	11.1	10.1	
06	15	0.37	47	27	22	18.3	15.7	13.7	11.0	9.2	7.8	6.9	6.1	5.5	5.0
	20	0.42	54	31	25	21	17.8	15.6	12.5	10.4	8.9	7.8	6.9	6.2	5.7
	30	0.52	67	39	31	26	22	19.3	15.4	12.9	11.0	9.7	8.6	7.7	7.0
	40	0.60	77	45	36	30	25	22	17.8	14.9	12.7	11.1	9.9	8.9	8.1
	50	0.67	86	50	40	33	28	25	19.9	16.6	14.2	12.4	11.1	9.9	9.0
	60	0.73	93	54	43	36	31	27	22	18.1	15.5	13.6	12.0	10.8	9.9
	75	0.82	105	61	49	41	35	30	24	20	17.4	15.2	13.5	12.2	11.1
90	0.90	115	67	53	45	38	33	27	22	19.1	16.7	14.9	13.4	12.2	
08	15	0.49	63	36	29	24	21	18.2	14.6	12.1	10.4	9.1	8.1	7.3	6.6
	20	0.57	73	42	34	28	24	21	16.9	14.1	12.1	10.6	9.4	8.5	7.7
	30	0.69	88	51	41	34	29	26	20	17.1	14.6	12.8	11.4	10.2	9.3
	40	0.80	102	59	48	40	34	30	24	19.8	17.0	14.9	13.2	11.9	10.8
	50	0.89	114	66	53	44	38	33	26	22	18.9	16.5	14.7	13.2	12.0
	60	0.98	125	73	58	49	42	36	29	24	21	18.2	16.2	14.6	13.2
	75	1.10	141	82	65	54	47	41	33	27	23	20	18.2	16.3	14.9
90	1.20	154	89	71	59	51	45	36	30	25	22	19.8	17.8	16.2	
10	15	0.61	78	45	36	30	26	23	18.1	15.1	12.9	11.3	10.1	9.1	8.2
	20	0.71	91	53	42	35	30	26	21	17.6	15.1	13.2	11.7	10.5	9.6
	30	0.87	111	65	52	43	37	32	26	22	18.5	16.1	14.4	12.9	11.7
	40	1.00	128	74	59	50	42	37	30	25	21	18.6	16.5	14.9	13.5
	50	1.12	143	83	67	55	48	42	33	28	24	21	18.5	16.6	15.1
	60	1.22	156	91	72	60	52	45	36	30	26	23	20	18.1	16.5
	75	1.37	175	102	81	68	58	51	41	34	29	25	23	20	18.5
90	1.50	192	111	89	74	64	56	45	37	32	28	25	22	20	
15	15	0.92	118	68	55	46	39	34	27	23	19.5	17.1	15.2	13.7	12.4
	20	1.06	136	79	63	52	45	39	31	26	22	19.7	17.5	15.7	14.3
	30	1.30	166	97	77	64	55	48	39	32	28	24	21	19.3	17.6
	40	1.50	192	111	89	74	64	56	45	37	32	28	25	22	20
	50	1.68	215	125	100	83	71	62	50	42	36	31	28	25	23
	60	1.84	236	137	109	91	78	68	55	46	39	34	30	27	25
	75	2.05	262	152	122	101	87	76	61	51	43	38	34	30	28
90	2.25	288	167	134	111	95	84	67	56	48	42	37	33	30	
20	15	1.22	156	91	72	60	52	45	36	30	26	23	20	18.1	16.5
	20	1.41	180	105	84	70	60	52	42	35	30	26	23	21	19.0
	30	1.73	221	128	103	86	73	64	51	43	37	32	29	26	23
	40	2.00	256	149	119	99	85	74	59	50	42	37	33	30	27
	50	2.24	287	166	133	111	95	83	67	55	48	42	37	33	30
	60	2.45	314	182	146	121	104	91	73	61	52	45	40	36	33
	75	2.74	351	203	163	136	116	102	81	68	58	51	45	41	37
90	3.00	384	223	178	149	127	111	89	74	64	56	50	45	41	

$$A = \frac{B+C}{D}$$

Technical Information

Universal Application Rate Chart for 30" Tip Spacing

TIP CAPACITY	LIQUID PRESSURE IN PSI	CAPACITY 1 NOZZLE IN GPM	CAPACITY 1 NOZZLE IN OZ./MIN.	GALLONS PER ACRE - 30" NOZZLE SPACING											
				4 MPH	5 MPH	6 MPH	7 MPH	8 MPH	10 MPH	12 MPH	14 MPH	16 MPH	18 MPH	20 MPH	22 MPH
01	15	0.061	7.8	3.0	2.4	2.0	1.7	1.5	1.2	1.0	0.86	0.75	0.67	0.60	0.55
	20	0.071	9.1	3.5	2.8	2.3	2.0	1.8	1.4	1.2	1.0	0.88	0.78	0.70	0.64
	30	0.087	11	4.3	3.4	2.9	2.5	2.2	1.7	1.4	1.2	1.1	0.96	0.86	0.78
	40	0.10	13	5.0	4.0	3.3	2.8	2.5	2.0	1.7	1.4	1.2	1.1	0.99	0.90
	50	0.11	14	5.4	4.4	3.6	3.1	2.7	2.2	1.8	1.6	1.4	1.2	1.1	0.99
	60	0.12	15	5.9	4.8	4.0	3.4	3.0	2.4	2.0	1.7	1.5	1.3	1.2	1.1
	75	0.14	18	6.9	5.5	4.6	4.0	3.5	2.8	2.3	2.0	1.7	1.5	1.4	1.3
90	0.15	19	7.4	5.9	5.0	4.2	3.7	3.0	2.5	2.1	1.9	1.7	1.5	1.4	
015	15	0.092	12	4.6	3.6	3.0	2.6	2.3	1.8	1.5	1.3	1.1	1.0	0.91	0.83
	20	0.11	14	5.4	4.4	3.6	3.1	2.7	2.2	1.8	1.6	1.4	1.2	1.1	0.99
	30	0.13	17	6.4	5.1	4.3	3.7	3.2	2.6	2.1	1.8	1.6	1.4	1.3	1.2
	40	0.15	19	7.4	5.9	5.0	4.2	3.7	3.0	2.5	2.1	1.9	1.7	1.5	1.4
	50	0.17	22	8.4	6.7	5.6	4.8	4.2	3.4	2.8	2.4	2.1	1.9	1.7	1.5
	60	0.18	23	8.9	7.1	5.9	5.1	4.5	3.6	3.0	2.5	2.2	2.0	1.8	1.6
	75	0.21	27	10.4	8.3	6.9	5.9	5.2	4.2	3.5	3.0	2.6	2.3	2.1	1.9
90	0.23	29	11.4	9.1	7.6	6.5	5.7	4.6	3.8	3.3	2.8	2.5	2.3	2.1	
02	15	0.12	15	5.9	4.8	4.0	3.4	3.0	2.4	2.0	1.7	1.5	1.3	1.2	1.1
	20	0.14	18	6.9	5.5	4.6	4.0	3.5	2.8	2.3	2.0	1.7	1.5	1.4	1.3
	30	0.17	22	8.4	6.7	5.6	4.8	4.2	3.4	2.8	2.4	2.1	1.9	1.7	1.5
	40	0.20	26	9.9	7.9	6.6	5.7	5.0	4.0	3.3	2.8	2.5	2.2	2.0	1.8
	50	0.22	28	10.9	8.7	7.3	6.2	5.4	4.4	3.6	3.1	2.7	2.4	2.2	2.0
	60	0.24	31	11.9	9.5	7.9	6.8	5.9	4.8	4.0	3.4	3.0	2.6	2.4	2.2
	75	0.27	35	13.4	10.7	8.9	7.6	6.7	5.3	4.5	3.8	3.3	3.0	2.7	2.4
90	0.30	38	14.9	11.9	9.9	8.5	7.4	5.9	5.0	4.2	3.7	3.3	3.0	2.7	
025	15	0.15	19	7.4	5.9	5.0	4.2	3.7	3.0	2.5	2.1	1.9	1.7	1.5	1.4
	20	0.18	23	8.9	7.1	5.9	5.1	4.5	3.6	3.0	2.5	2.2	2.0	1.8	1.6
	30	0.22	28	10.9	8.7	7.3	6.2	5.4	4.4	3.6	3.1	2.7	2.4	2.2	2.0
	40	0.25	32	12.4	9.9	8.3	7.1	6.2	5.0	4.1	3.5	3.1	2.8	2.5	2.3
	50	0.28	36	13.9	11.1	9.2	7.9	6.9	5.5	4.6	4.0	3.5	3.1	2.8	2.5
	60	0.31	40	15.3	12.3	10.2	8.8	7.7	6.1	5.1	4.4	3.8	3.4	3.1	2.8
	75	0.34	44	16.8	13.5	11.2	9.6	8.4	6.7	5.6	4.8	4.2	3.7	3.4	3.1
90	0.38	49	18.8	15.0	12.5	10.7	9.4	7.5	6.3	5.4	4.7	4.2	3.8	3.4	
03	15	0.18	23	8.9	7.1	5.9	5.1	4.5	3.6	3.0	2.5	2.2	2.0	1.8	1.6
	20	0.21	27	10.4	8.3	6.9	5.9	5.2	4.2	3.5	3.0	2.6	2.3	2.1	1.9
	30	0.26	33	12.9	10.3	8.6	7.4	6.4	5.1	4.3	3.7	3.2	2.9	2.6	2.3
	40	0.30	38	14.9	11.9	9.9	8.5	7.4	5.9	5.0	4.2	3.7	3.3	3.0	2.7
	50	0.34	44	16.8	13.5	11.2	9.6	8.4	6.7	5.6	4.8	4.2	3.7	3.4	3.1
	60	0.37	47	18.3	14.7	12.2	10.5	9.2	7.3	6.1	5.2	4.6	4.1	3.7	3.3
	75	0.41	52	20	16.2	13.5	11.6	10.1	8.1	6.8	5.8	5.1	4.5	4.1	3.7
90	0.45	58	22	17.8	14.9	12.7	11.1	8.9	7.4	6.4	5.6	5.0	4.5	4.1	
04	15	0.24	31	11.9	9.5	7.9	6.8	5.9	4.8	4.0	3.4	3.0	2.6	2.4	2.2
	20	0.28	36	13.9	11.1	9.2	7.9	6.9	5.5	4.6	4.0	3.5	3.1	2.8	2.5
	30	0.35	45	17.3	13.9	11.6	9.9	8.7	6.9	5.8	5.0	4.3	3.9	3.5	3.2
	40	0.40	51	19.8	15.8	13.2	11.3	9.9	7.9	6.6	5.7	5.0	4.4	4.0	3.6
	50	0.45	58	22	17.8	14.9	12.7	11.1	8.9	7.4	6.4	5.6	5.0	4.5	4.1
	60	0.49	63	24	19.4	16.2	13.9	12.1	9.7	8.1	6.9	6.1	5.4	4.9	4.4
	75	0.55	70	27	22	18.2	15.6	13.6	10.9	9.1	7.8	6.8	6.1	5.4	5.0
90	0.60	77	30	24	19.8	17.0	14.9	11.9	9.9	8.5	7.4	6.6	5.9	5.4	
05	15	0.31	40	15.3	12.3	10.2	8.8	7.7	6.1	5.1	4.4	3.8	3.4	3.1	2.8
	20	0.35	45	17.3	13.9	11.6	9.9	8.7	6.9	5.8	5.0	4.3	3.9	3.5	3.2
	30	0.43	55	21	17.0	14.2	12.2	10.6	8.5	7.1	6.1	5.3	4.7	4.3	3.9
	40	0.50	64	25	19.8	16.5	14.1	12.4	9.9	8.3	7.1	6.2	5.5	5.0	4.5
	50	0.56	72	28	22	18.5	15.8	13.9	11.1	9.2	7.9	6.9	6.2	5.5	5.0
	60	0.61	78	30	24	20	17.3	15.1	12.1	10.1	8.6	7.5	6.7	6.0	5.5
	75	0.68	87	34	27	22	19.2	16.8	13.5	11.2	9.6	8.4	7.5	6.7	6.1
90	0.75	96	37	30	25	21	18.6	14.9	12.4	10.6	9.3	8.3	7.4	6.8	
06	15	0.37	47	18.3	14.7	12.2	10.5	9.2	7.3	6.1	5.2	4.6	4.1	3.7	3.3
	20	0.42	54	21	16.6	13.9	11.9	10.4	8.3	6.9	5.9	5.2	4.6	4.2	3.8
	30	0.52	67	26	21	17.2	14.7	12.9	10.3	8.6	7.4	6.4	5.7	5.1	4.7
	40	0.60	77	30	24	19.8	17.0	14.9	11.9	9.9	8.5	7.4	6.6	5.9	5.4
	50	0.67	86	33	27	22	19.0	16.6	13.3	11.1	9.5	8.3	7.4	6.6	6.0
	60	0.73	93	36	29	24	21	18.1	14.5	12.0	10.3	9.0	8.0	7.2	6.6
	75	0.82	105	41	32	27	23	20	16.2	13.5	11.6	10.1	9.0	8.1	7.4
90	0.90	115	45	36	30	25	22	17.8	14.9	12.7	11.1	9.9	8.9	8.1	
08	15	0.49	63	24	19.4	16.2	13.9	12.1	9.7	8.1	6.9	6.1	5.4	4.9	4.4
	20	0.57	73	28	23	18.8	16.1	14.1	11.3	9.4	8.1	7.1	6.3	5.6	5.1
	30	0.69	88	34	27	23	19.5	17.1	13.7	11.4	9.8	8.5	7.6	6.8	6.2
	40	0.80	102	40	32	26	23	19.8	15.8	13.2	11.3	9.9	8.8	7.9	7.2
	50	0.89	114	44	35	29	25	22	17.6	14.7	12.6	11.0	9.8	8.8	8.0
	60	0.98	125	49	39	32	28	24	19.4	16.2	13.9	12.1	10.8	9.7	8.8
	75	1.10	141	54	44	36	31	27	22	18.2	15.6	13.6	12.1	10.9	9.9
90	1.20	154	59	48	40	34	30	24	19.8	17.0	14.9	13.2	11.9	10.8	
10	15	0.61	78	30	24	20	17.3	15.1	12.1	10.1	8.6	7.5	6.7	6.0	5.5
	20	0.71	91	35	28	23	20	17.6	14.1	11.7	10.0	8.8	7.8	7.0	6.4
	30	0.87	111	43	34	29	25	22	17.2	14.4	12.3	10.8	9.6	8.6	7.8
	40	1.00	128	50	40	33	28	25	19.8	16.5	14.1	12.4	11.0	9.9	9.0
	50	1.12	143	55	44	37	32	28	22	18.5	15.8	13.9	12.3	11.1	10.1
	60	1.22	156	60	48	40	35	30	24	20	17.3	15.1	13.4	12.1	11.0
	75	1.37	175	68	54	45	39	34	27	23	19.4	17.0	15.1	13.6	12.3
90	1.50	192	74	59	50	42	37	30	25	21	18.6	16.5	14.9	13.5	
15	15	0.92	118	46	36	30	26	23	18.2	15.2	13.0	11.4	10.1	9.1	8.3
	20	1.06	136	52	42	35	30	26	21	17.5	15.0	13.1	11.7	10.5	9.5
	30	1.30	166	64	51	43	37	32	26	21	18.4	16.1	14.3	12.9	11.7
	40	1.50	192	74	59	50	42	37	30	25	21	18.6	16.5	14.9	13.5
	50	1.68	215	83	67	55	48	42	33	28	24	21	18.5	16.6	15.1
	60	1.84	236	91	73	61	52	46	36	30	26	23	20	18.2	16.6
	75	2.05	262	101	81	68	58	51	41	34	29	25	23	20	18.5
90	2.25	288	111	89	74	64	56	45	37	32	28	25	22	20	
20	15	1.22	156	60	48	40	35	30	24	20	17.3	15.1	13.4	12.1	11.0
	20	1.41	180	70	56	47	40	35	28	23	19.9	17.4	15.5	14.0	12.7
	30	1.73	221	86	69	57	49	43	34	29	24	21	19.0	17.1	15.6
	40	2.00	256	99	79	66	57	50	40	33	28	25	22	19.8	18.0
	50	2.24	287	111	89	74	63	55	44	37	32	28	25	22	20
	60	2.45	314	121	97	81	69	61	49	40	35	30	27	24	22
	75	2.74	351	136	109	90	78	68	54	45	39	34	30	27	25
90	3.00	384	149	119											

Calibration/Adjustment Accessories

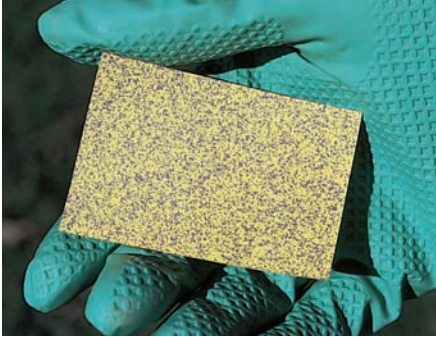

Water and Oil Sensitive Paper

These specially coated papers are used for evaluating spray distributions, swath widths, droplet densities and penetration of spray. Water sensitive paper is yellow and is stained blue by exposure to aqueous spray droplets. White oil sensitive paper turns black in areas exposed to oil droplets. For more information on water sensitive paper see Data Sheet 20301; for more information on oil sensitive paper see Data Sheet 20302.

Water and oil sensitive paper sold by TeeJet Technologies is manufactured by Syngenta Crop Protection AG.



WATER SENSITIVE PAPER		
PART NUMBER	PAPER SIZE	QUANTITY/PACKAGE
20301-1N	3" x 1"	50 cards
20301-2N	3" x 2"	50 cards
20301-3N	20" x 1"	25 strips

OIL SENSITIVE PAPER		
PART NUMBER	PAPER SIZE	QUANTITY/PACKAGE
20302-1	3" x 2"	50 cards

How to order:

Specify part number.

Example: 20301-1N

Water Sensitive Paper

TeeJet Tip Cleaning Brush



How to order:

Specify part number.

Example: CP20016-NY

TeeJet Calibration Container

The TeeJet Calibration Container features a 68 oz. (2.0 L) capacity and a raised dual scale in both U.S. and metric graduations. The container is molded of polypropylene for excellent chemical resistance and durability.

How to order:

Example: CP24034A-PP

(Calibration Container only)



Useful Formulas

$$\text{GPM (Per Nozzle)} = \frac{\text{GPA} \times \text{MPH} \times \text{W}}{5,940}$$

$$\text{GPM (Per Nozzle)} = \frac{\text{GAL}/1000\text{FT}^2 \times \text{MPH} \times \text{W}}{136}$$

$$\text{GPA} = \frac{5,940 \times \text{GPM (Per Nozzle)}}{\text{MPH} \times \text{W}}$$

$$\text{GAL}/1000\text{FT}^2 = \frac{136 \times \text{GPM (Per Nozzle)}}{\text{MPH} \times \text{W}}$$

GPM – Gallons Per Minute

GPA – Gallons Per Acre

GAL/1000FT² – Gallons Per 1000 Square Feet

MPH – Miles Per Hour

W – Nozzle spacing (in inches) for broadcast spraying

– Spray width (in inches) for single nozzle, band spraying or boomless spraying

– Row spacing (in inches) divided by the number of nozzles per row for directed spraying

Nozzle Spacing

If the nozzle spacing on your boom is different than those tabulated, multiply the tabulated GPA coverages by one of the following factors.

20'	
OTHER SPACING (INCHES)	CONVERSION FACTOR
8	2.5
10	2
12	1.67
14	1.43
16	1.25
18	1.11
22	.91
24	.83
30	.66

Useful Formulas for Roadway Applications

$$\text{GPLM} = \frac{60 \times \text{GPM}}{\text{MPH}} \quad \text{GPM} = \frac{\text{GPLM} \times \text{MPH}}{60}$$

GPLM = Gallons Per Lane Mile

Note: GPLM is not a normal volume per unit area measurement. It is a volume per distance measurement. Increases or decreases in lane width (swath width) are not accommodated by these formulas.

Measuring Travel Speed

Measure a test course in the area to be sprayed or in an area with similar surface conditions. Minimum lengths of 100 and 200 feet are recommended for measuring speeds up to 5 and 10 MPH, respectively. Determine the time required to travel the test course. To help ensure accuracy, conduct the speed check with a partially loaded (about half full) sprayer and select the engine throttle setting and gear that will be used when spraying. Repeat the above process and average the times that were measured. Use the following equation or the table at right to determine ground speed.

$$\text{Speed (MPH)} = \frac{\text{Distance (FT)} \times 60}{\text{Time (seconds)} \times 88}$$

Speeds

SPEED IN MPH	TIME REQUIRED IN SECONDS TO TRAVEL A DISTANCE OF:		
	100 Feet	200 Feet	300 Feet
1.0	68	136	205
1.5	45	91	136
2.0	34	68	102
2.5	27	55	82
3.0	23	45	68
3.5	19	39	58
4.0	17	34	51
4.5	15	30	45
5.0	14	27	41
5.5	—	25	37
6.0	—	23	34
6.5	—	21	31
7.0	—	19	29
7.5	—	18	27
8.0	—	17	26
8.5	—	16	24
9.0	—	15	23

30'	
OTHER SPACING (INCHES)	CONVERSION FACTOR
26	1.15
28	1.07
32	.94
34	.88
36	.83
38	.79
40	.75
42	.71
44	.68

40'	
OTHER SPACING (INCHES)	CONVERSION FACTOR
28	1.43
30	1.33
32	1.25
34	1.18
36	1.11
38	1.05
42	.95
44	.91
48	.83

Miscellaneous Conversion Factors

One Acre = 43,560 Square Feet
= 43.56 1000FT² Blocks
= 0.405 Hectare

One Hectare = 2.471 Acres

One Gallon Per Acre

= 2.9 Fluid Ounces per 1000FT²
= 9.35 Liters Per Hectare

One Gallon Per 1000FT² = 43.56 GPA

One Mile = 5,280 Feet
= 1,610 Meters
= 1.61 Kilometers

One Gallon = 128 Fluid Ounces
= 8 Pints
= 4 Quarts
= 3.79 Liters
= 0.83 Imperial Gallon



One Pound Per Square Inch

= 0.069 bar
= 6.896 Kilopascals

One Mile Per Hour = 1.609 Kilometers Per Hour

Suggested Minimum Spray Heights

The nozzle height suggestions in the table below are based on the minimum overlap required to obtain uniform distribution. However, in many cases, typical height adjustments are based on a 1 to 1 nozzle spacing to height ratio. For example, 110° flat spray tips spaced 20 inches apart are commonly set 20 inches above the target.

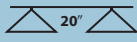
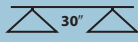
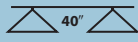
	(Inches)			
				
TP, TJ	65°	22–24"	33–35"	NR*
TP, XR, TX, DG, TJ, AI, XRC	80°	17–19"	26–28"	NR*
TP, XR, DG, TT, TTI, TJ, DGTJ, AI, AIXR, AIC, XRC, TTJ, AITTJ	110°	16–18"	20–22"	NR*
FullJet®	120°	10–18"***	14–18"***	14–18"***
FloodJet® TK, TF, K, QCK, QCTF, 1/4TTJ	120°	14–16"****	15–17"****	18–20"****

* Not recommended.

** Nozzle height based on 30° to 45° angle of orientation.

*** Wide angle spray tip height is influenced by nozzle orientation. The critical factor is to achieve a double spray pattern overlap.

Technical Information

Spraying Liquids with a Density Other Than Water

Since all the tabulations in this catalog are based on spraying water, which weighs 8.34 lbs. per USA gallon, conversion factors must be used when spraying liquids that are heavier or lighter than water. To determine the proper size nozzle for the liquid to be sprayed, first multiply the desired GPM or GPA of liquid by the water rate conversion factor. Then use the new converted GPM or GPA rate to select the proper size nozzle.

Example:

Desired application rate is 20 GPA of 28%N. Determine the correct nozzle size as follows:

$$\begin{aligned} &\text{GPA (liquid other than water)} \times \\ &\text{Conversion Factor} \\ &= \text{GPA (from table in catalog)} \\ &20 \text{ GPA (28\%)} \times 1.13 \\ &= 22.6 \text{ GPA (water)} \end{aligned}$$

The applicator should choose a nozzle size that will supply 22.6 GPA of water at the desired pressure.

WEIGHT OF SOLUTION	SPECIFIC GRAVITY	CONVERSION FACTOR
7.0 lbs./gal.	.84	.92
8.0 lbs./gal.	.96	.98
8.34 lbs./gal.	1.00 – WATER	1.00
9.0 lbs./gal.	1.08	1.04
10.0 lbs./gal.	1.20	1.10
10.65 lbs./gal.	1.28 – 28% nitrogen	1.13
11.0 lbs./gal.	1.32	1.15
12.0 lbs./gal.	1.44	1.20
14.0 lbs./gal.	1.68	1.30

Spray Coverage Information

This table lists the theoretical coverage of spray patterns as calculated from the included spray angle of the spray and the distance from the nozzle orifice. These values are based on the assumption that the spray angle remains the same throughout the entire spray distance. In actual practice, the tabulated spray angle does not hold for long spray distances.

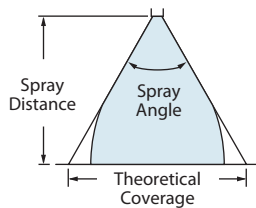

INCLUDED SPRAY ANGLE	THEORETICAL COVERAGE AT VARIOUS SPRAY HEIGHTS (IN INCHES)							
	8"	10"	12"	15"	18"	24"	30"	36"
15°	2.1	2.6	3.2	3.9	4.7	6.3	7.9	9.5
20°	2.8	3.5	4.2	5.3	6.4	8.5	10.6	12.7
25°	3.5	4.4	5.3	6.6	8.0	10.6	13.3	15.9
30°	4.3	5.4	6.4	8.1	9.7	12.8	16.1	19.3
35°	5.0	6.3	7.6	9.5	11.3	15.5	18.9	22.7
40°	5.8	7.3	8.7	10.9	13.1	17.5	21.8	26.2
45°	6.6	8.3	9.9	12.4	14.9	19.9	24.8	29.8
50°	7.5	9.3	11.2	14.0	16.8	22.4	28.0	33.6
55°	8.3	10.3	12.5	15.6	18.7	25.0	31.2	37.5
60°	9.2	11.5	13.8	17.3	20.6	27.7	34.6	41.6
65°	10.2	12.7	15.3	19.2	22.9	30.5	38.2	45.8
73°	11.8	14.8	17.8	22.0	27.0	36.0	44.0	53.0
80°	13.4	16.8	20.2	25.2	30.3	40.3	50.4	60.4
85°	14.7	18.3	22.0	27.5	33.0	44.0	55.4	66.4
90°	16.0	20.0	24.0	30.0	36.0	48.0	60.0	72.0
95°	17.5	21.8	26.2	32.8	40.3	52.4	65.5	78.6
100°	19.1	23.8	28.6	35.8	43.0	57.2	71.6	85.9
110°	22.8	28.5	34.3	42.8	51.4	68.5	85.6	103
120°	27.7	34.6	41.6	52.0	62.4	83.2	104	
130°	34.3	42.9	51.5	64.4	77.3	103		
140°	43.8	54.8	65.7	82.2	98.6			
150°	59.6	74.5	89.5					

Nozzle Nomenclature

There are many types of nozzles available, with each providing different flow rates, spray angles, droplet sizes and patterns. Some of these spray tip characteristics are indicated by the tip number.

Remember, when replacing tips, be sure to purchase the same tip number, thereby ensuring your sprayer remains properly calibrated.

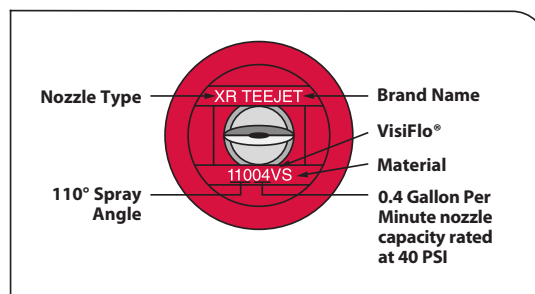

Information About Spray Pressure

Flow Rate

Nozzle flow rate varies with spraying pressure. In general, the relationship between GPM and pressure is as follows:

$$\frac{GPM_1}{GPM_2} = \frac{\sqrt{PSI_1}}{\sqrt{PSI_2}}$$

This equation is explained by the illustration to the right. Simply stated, in order to double the flow through a nozzle, the pressure must be increased four times.

Higher pressure not only increases the flow rate through a nozzle, but it also influences the droplet size and the rate of orifice wear. As pressure is increased, the droplet size decreases and the rate of orifice wear increases.

The values given in the tabulation sections of this catalog indicate the most commonly used pressure ranges for the associated spray tips. When information on the performance of spray tips outside of the pressure range given in this catalog is required, contact TeeJet Technologies or your local rep.

Spray Angle and Coverage

Depending on the nozzle type and size, the operating pressure can have a significant effect on spray angle and quality of spray distribution. As shown here for an 11002 flat spray tip, lowering the pressure results in a smaller spray angle and a significant reduction in spray coverage.

Tabulations for spray tips in this catalog are based on spraying water. Generally, liquids more viscous than water produce relatively smaller spray angles, while liquids with surface tensions lower than water will produce wider spray angles. In situations where the uniformity of spray distribution is important, be careful to operate your spray tips within the proper pressure range.

Note: Suggested minimum spray heights for broadcast spraying are based upon nozzles spraying water at the rated spray angle.

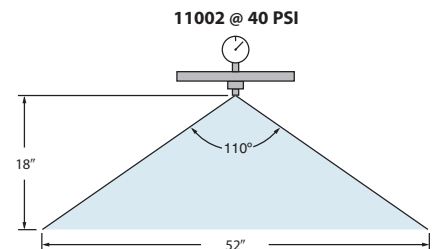
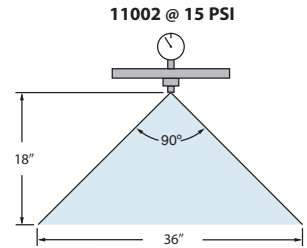
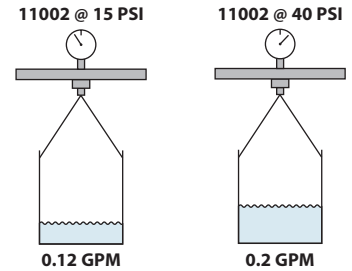

Pressure Drop Through Various Hose Sizes

FLOW IN GPM	PRESSURE DROP IN PSI (10' [3 m] LENGTH WITHOUT COUPLINGS)				
	¼" I.D.	3/8" I.D.	½" I.D.	¾" I.D.	1" I.D.
0.5	1.4	.2			
1.0		.7			
1.5		1.4	.4		
2.0		2.4	.6		
2.5		3.4	.9		
3.0			1.2		
4.0			2.0		
5.0			2.9	.4	
6.0			4.0	.6	
8.0				.9	.3
10.0				1.4	.4

Helpful Reminders for Band Spraying

Wider angle spray tips allow the spray height to be lowered to minimize drift.

Example:

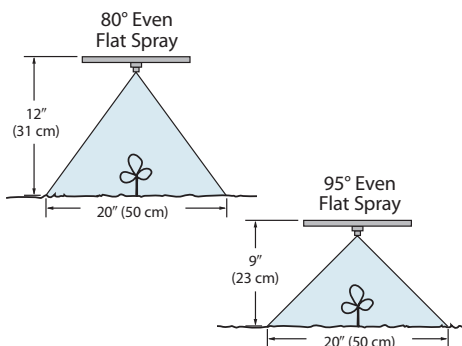

The spray angle of the nozzle and the resulting band width are directly influenced by the spraying pressure.

Example: 8002E Even Flat Spray

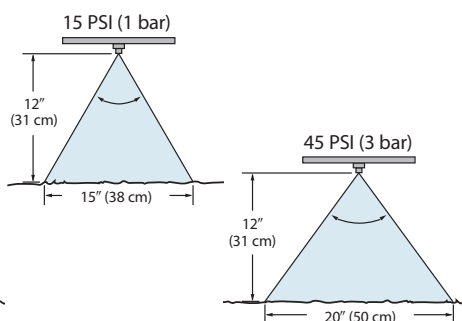

Use care when calculating:
Field Acres/Hectares vs. Treated Acres/Hectares

Field Acres/Hectares = Total Acres/Hectares of Planted Cropland

Treated Acres/Hectares =
Field Acres/Hectares X Band Width
Row Spacing

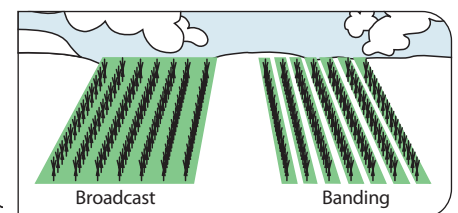

Pressure Drop Through Sprayer Components

COMPONENT NUMBER	TYPICAL PRESSURE DROP (PSI) AT VARIOUS FLOW RATES (GPM)																						
	0.5 GPM	1.0 GPM	2.0 GPM	3.0 GPM	4.0 GPM	5.0 GPM	6.0 GPM	7.0 GPM	8.0 GPM	9.0 GPM	10 GPM	15 GPM	18 GPM	24 GPM	32 GPM	48 GPM	64 GPM	75 GPM	100 GPM	125 GPM	150 GPM	200 GPM	
AA2 GunJet		0.2	0.9	2.0	3.4	5.3	7.3	10.0	13.0	16.0													
AA18 GunJet		0.6	2.2	5.0	8.3	13.0	18.4	25.0	33.0	40.0													
AA30L GunJet		0.6	2.2	5.0	9.0	14.0	20.2	27.5															
AA43 GunJet				0.4	0.6	1.0	1.5	2.0	2.6	3.3	4.1	9.2	13.2										
AA143 GunJet				0.3	0.6	0.9	1.3	1.7	2.2	2.8	3.5	7.9	11.3										
AA6B Valve				0.3	0.6	0.9	1.3	1.7	2.2	2.8	3.5	7.8	11.3	20.0									
AA17 Valve			0.2	0.5	0.8	1.3	1.8	2.5	3.2	4.1	5.0	11.3	16.2	28.8									
AA144A/144P Valve			0.2	0.5	0.8	1.3	1.8	2.5	3.2	4.1	5.0	11.3	16.2	28.8									
AA144A-1-3/AA144P-1-3 Valve			0.3	0.7	1.3	2.0	2.8	3.8	5.0	6.3	7.8	17.6	25.3										
AA145H Valve				0.2	0.4	0.6	0.8	1.1	1.4	1.8	2.2	5.0	7.2	12.8	22.8								
344 2-way Valve								0.2	0.3	0.4	0.5	1.1	1.6	2.8	5.0	11.3	20.0	27.5					
344 3-way Valve						0.2	0.3	0.4	0.6	0.7	0.9	2.0	2.8	5.0	8.9	20.0	35.6						
346 2-way Valve												0.1	0.2	0.3	0.5	1.2	2.0	2.8	5.0	7.8	11.3	20.0	
346 3-way Valve												0.3	0.4	0.7	1.3	2.8	5.0	6.9	12.2	19.1	27.5		
356 Valve												0.1	0.2	0.3	0.5	1.2	2.0	2.8	5.0	7.8	11.3	20.0	
430 2-way* Manifold			0.1	0.3	0.6	0.9	1.3	1.8	2.3	3.0	3.7	8.2	11.8	21.0									
430 3-way* Manifold			0.1	0.3	0.6	0.9	1.3	1.8	2.3	3.0	3.7	8.2	11.8	21.0									
430 FB* Manifold			0.2	0.5	0.9	1.5	2.1	2.9	3.8	4.8	5.9	13.3	19.1										
440* Manifold						0.2	0.3	0.4	0.5	0.6	0.7	1.7	2.4	4.3	7.6	17.0	30.3						
450* Manifold						0.1	0.2	0.2	0.3	0.4	0.5	1.1	1.6	2.8	5.0	11.3	20.0	27.5					
450 FB* Manifold						0.1	0.2	0.2	0.3	0.4	0.5	1.1	1.6	2.8	5.0	11.3	20.0	27.5					
460 2-way* Manifold						0.2	0.3	0.4	0.5	0.6	0.8	1.8	2.6	4.6	8.2	18.4	32.8						
460 3-way* Manifold						0.2	0.3	0.4	0.5	0.6	0.8	1.8	2.6	4.6	8.2	18.4	32.8						
460 FB* Manifold						0.2	0.3	0.4	0.6	0.7	0.9	2.0	2.8	5.0	8.9	20.0	35.6						
490* Manifold												0.1	0.2	0.3	0.5	1.2	2.0	2.8	5.0	7.8	11.3	20.0	
540* Manifold						0.2	0.2	0.3	0.4	0.6	0.7	1.5	2.2	4.0	7.0	15.8	28.1						
QJ300 Nozzle Body	0.1	0.4	1.6	3.7	6.5	10.2	14.7	20.0															
QJ360C Nozzle Body	0.2	1.0	4.0	8.9	15.8	24.7																	
QJ360E Nozzle Body	0.6	2.2	8.9	20.0	35.6																		
QJ360F Nozzle Body	0.1	0.4	1.7	3.9	6.9	10.8	15.6	21.2	27.7	35.0													
QJ380 Nozzle Body	0.1	0.6	2.2	5.0	8.9	13.9	20.0	27.2	35.6														
QJ380F Nozzle Body	0.1	0.2	1.0	2.2	4.0	6.2	8.9	12.1	15.8	20.0	24.7												
24230A/24216A Nozzle Body	0.5	2.0	7.8	17.6	31.3																		
QJ17560A Nozzle Body	0.2	1.0	4.0	8.9	15.8	24.7																	
AA122-1/2 Line Strainer				0.3	0.6	0.9	1.3	1.7	2.2	2.8	3.5	7.8	11.3	20.0									
AA122-3/4 Line Strainer				0.2	0.3	0.5	0.7	1.0	1.3	1.6	2.0	4.4	6.3	11.3	20.0								
AA122-QC Line Strainer				0.1	0.2	0.4	0.6	0.8	1.0	1.3	1.5	3.5	5.0	8.9	15.8	35.6							
AA126-3 Line Strainer						0.2	0.3	0.5	0.6	0.8	0.9	2.1	3.1	5.4	9.7	21.8							
AA126-4/F50/M50 Line Strainer								0.2	0.3	0.3	0.4	0.9	1.3	2.4	4.2	9.4	16.7	23.0					
AA126-5 Line Strainer												0.3	0.5	0.8	1.5	3.3	5.9	8.1	14.4	22.4			
AA126-6/F75 Line Strainer												0.2	0.3	0.5	0.9	1.9	3.5	4.7	8.4	13.2	19.0		

*Manifold pressure drop data based on a single valve. Quantity of valves, inlet fitting size and inlet feed setup may affect pressure drop rating. Please contact your local TeeJet sale representative for additional information.

Area Measurement

It is essential to know the amount of area that you intend to cover when applying a pesticide or fertilizer. Turf areas such as home lawns and golf course greens, tees and fairways should be measured in square feet or acres, depending upon the units needed.

Rectangular Areas

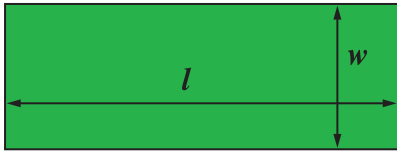

Area = Length (l) x Width (w)

Example:

What is the area of a lawn that is 300 feet long and 150 feet wide?

$$\begin{aligned} \text{Area} &= 300 \text{ feet} \times 150 \text{ feet} \\ &= 45,000 \text{ square feet} \end{aligned}$$

By using the following equation, it is possible to determine the area in acres.

$$\text{Area in acres} = \frac{\text{Area in square feet}}{43,560 \text{ sq. ft. per acre}}$$

(There are 43,560 square feet in an acre.)

Example:

$$\begin{aligned} \text{Area in acres} &= \frac{45,000 \text{ sq. ft.}}{43,560 \text{ sq. ft. per acre}} \\ &= 1.03 \text{ acres} \end{aligned}$$

Triangular Areas

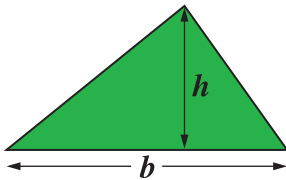

$$\text{Area} = \frac{\text{Base } (b) \times \text{Height } (h)}{2}$$

Example:

The base of a corner lot is 250 feet while the height is 50 feet. What is the area of the lot?

$$\begin{aligned} \text{Area} &= \frac{250 \text{ feet} \times 50 \text{ feet}}{2} \\ &= 6,250 \text{ square feet} \\ \text{Area in acres} &= \frac{6,250 \text{ square feet}}{43,560 \text{ sq. ft. per acre}} \\ &= 0.14 \text{ acre} \end{aligned}$$

Circular Areas

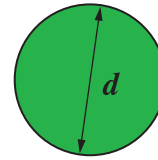

$$\text{Area} = \frac{\pi \times \text{Diameter}^2 (d)}{4}$$

$$\pi = 3.14159$$

Example:

What is the area of a green that has a diameter of 45 feet?

$$\text{Area} = \frac{\pi \times (45 \text{ feet})^2}{4} = \frac{3.14 \times 2025}{4}$$

$$= 1,590 \text{ square feet}$$

$$\begin{aligned} \text{Area in acres} &= \frac{1,590 \text{ square feet}}{43,560 \text{ sq. ft. per acre}} \\ &= 0.04 \text{ acre} \end{aligned}$$

Irregular Areas

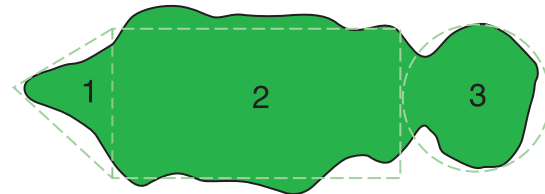

Any irregularly shaped turf area can usually be reduced to one or more geometric figures. The area of each figure is calculated and the areas are then added together to obtain the total area.

Example:

What is the total area of the Par-3 hole illustrated above?

The area can be broken into a triangle (area 1), a rectangle (area 2) and a circle (area 3). Then use the previously mentioned equations for determining areas to find the total area.

$$\text{Area 1} = \frac{25 \text{ feet} \times 30 \text{ feet}}{2} = 375 \text{ square feet}$$

$$\text{Area 2} = 25 \text{ feet} \times 475 \text{ feet} = 11,875 \text{ square feet}$$

$$\text{Area 3} = \frac{3.14 \times (45 \text{ feet})^2}{4} = 1,590 \text{ square feet}$$

$$\text{Total Area} = 375 + 11,875 + 1,590 = 13,840 \text{ square feet}$$

$$= \frac{13,840 \text{ square feet}}{43,560 \text{ sq. ft. per acre}} = 0.32 \text{ acre}$$

Sprayer Calibration

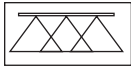

Broadcast Application

Sprayer calibration (1) **readies your sprayer for operation** and (2) **diagnoses tip wear**. This will give you optimum performance of your TeeJet® tips.

Equipment Needed:

- TeeJet Calibration Container
- Calculator
- TeeJet Cleaning Brush
- One new TeeJet Spray Tip matched to the nozzles on your sprayer
- Stopwatch or wristwatch with second hand

STEP NUMBER 1

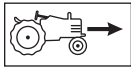

Check Your Tractor/Sprayer Speed!

Knowing your real sprayer speed is an essential part of accurate spraying. Speedometer readings and some electronic measurement devices can be inaccurate because of wheel slippage. Check the time required to move over a 100- or 200-foot strip on your field. Fence posts can serve as permanent markers. The starting post should be far enough away to permit your tractor/sprayer to reach desired spraying speed. Hold that speed as you travel between the “start” and “end” markers. Most accurate measurement will be obtained with the spray tank half full. Refer to the table on page 140 to calculate your real speed. When the correct throttle and gear settings are identified, mark your tachometer or speedometer to help you control this **vital** part of accurate chemical application.

STEP NUMBER 2

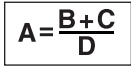

The Inputs

Before spraying, record the following:

	EXAMPLE
Nozzle type on your sprayer.	TT11004 Flat
(All nozzles must be identical)	Spray Tip
Recommended application volume20 GPA
(From manufacturer’s label)	
Measured sprayer speed6 MPH
Nozzle spacing20 Inches



STEP NUMBER 3

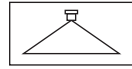

Calculating Required Nozzle Output

Determine GPM nozzle output from formula.

$$\text{FORMULA: } \text{GPM} = \frac{\text{GPA} \times \text{MPH} \times \text{W}}{5,940 \text{ (constant)}}$$

$$\text{EXAMPLE: } \text{GPM} = \frac{20 \times 6 \times 20}{5,940} = \frac{2,400}{5,940}$$

ANSWER: 0.404 GPM

STEP NUMBER 4



Setting the Correct Pressure

Turn on your sprayer and check for leaks or blockage. Inspect and clean, if necessary, all tips and strainers with TeeJet brush. Replace one tip and strainer **with an identical new tip and strainer** on sprayer boom.

Check appropriate tip selection table and determine the pressure required to deliver the nozzle output calculated from the formula in Step 3 for your new tip. Since all of the tabulations are based on spraying water, conversion factors must be used when spraying solutions that are heavier or lighter than water (see page 141).

Example: (Using above inputs) refer to TeeJet table on page 7 for TT11004 flat spray tip. The table shows that this nozzle delivers 0.40 GPM at 40 PSI.

Turn on your sprayer and adjust pressure. **Collect and measure the volume of the spray from the new tip for one minute in the collection jar.** Fine tune the pressure until you collect .40 GPM.

You have now adjusted your sprayer to the proper pressure. It will properly deliver the application rate specified by the chemical manufacturer at your measured sprayer speed.

STEP NUMBER 5



Checking Your System

Problem Diagnosis: Now, check the flow rate of a few tips on each boom section. If the flow rate of any tip is 10 percent greater or less than that of the newly installed spray tip, recheck the output of that tip. If only one tip is faulty, replace with new tip and strainer and your system is ready for spraying. However, if a second tip is defective, **replace all tips on the entire boom**. This may sound unrealistic, but two worn tips on a boom are ample indication of tip wear problems. Replacing only a couple of worn tips invites potentially serious application problems.

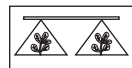

Banding and Directed Applications

The only difference between the above procedure and calibrating for banding or directed applications is the input value used for “W” in the formula in Step 3.

For single nozzle banding or boomless applications:

$$W = \text{Sprayed band width or swath width (in inches).}$$

For multiple nozzle directed applications:

$$W = \text{Row spacing (in inches) divided by the number of nozzles per row.}$$

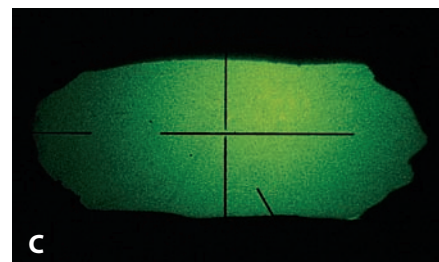
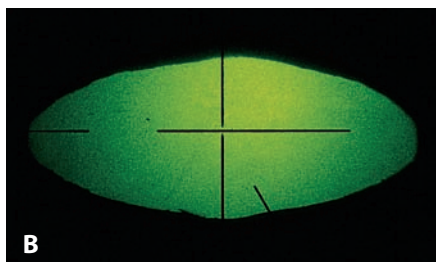
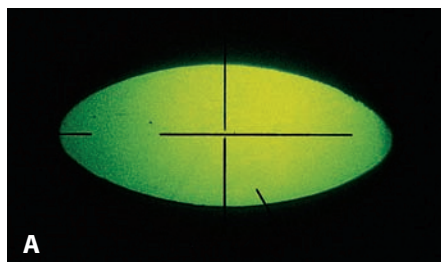

Tips Don't Last Forever!

There is sufficient evidence that spray tips may be the most neglected component in today's farming. Even in countries with obligatory sprayer testing, spray tips are the most significant failure. On the other hand, they are among the most critical of items in proper application of valuable agricultural chemicals.

For example, a 10 percent over-application of chemical on a twice-sprayed 1,000-acre farm could represent a loss of \$2,000–\$10,000 based on today's chemical investments of \$10.00–\$50.00 per acre. This does not take into account potential crop damage.

Spray Tip Care is the First Step to Successful Application

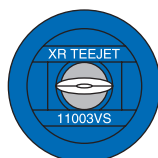

The successful performance of a crop chemical is highly dependent on its proper application as recommended by the chemical manufacturer. Proper selection and operation of spray nozzles are very important steps in accurate chemical application. The volume of spray passing through each nozzle plus the droplet size and spray distribution on the target can influence pest control.

Critical in controlling these three factors is the spray nozzle orifice. Careful craftsmanship

An Inside Look at Nozzle Orifice Wear and Damage

While wear may not be detected when visually inspecting a nozzle, it can be seen when viewed through an optical comparator. The edges of the worn nozzle (B) appear more rounded than the edges of the new nozzle (A). Damage to nozzle (C) was caused by improper cleaning.

The spraying results from these tips can be seen in the illustrations below.

Determining Tip Wear

The best way to determine if a spray tip is excessively worn is to compare the flow rate from the used tip to the flow rate of a new tip of the same size and type. Charts in this catalog indicate the flow rates for new nozzles. Check the flow of each tip by using an accurate graduated collection container, a timing device and an accurate pressure gauge mounted at the nozzle tip. Compare the flow rate of the old tip to that of the new one. Spray tips are considered excessively worn and should be replaced when their flow exceeds the flow of a new tip by 10%. Reference page 145 for more information.

goes into the precision manufacturing of each nozzle orifice. European standards, for example the JKI, require very small flow tolerances of new nozzles (+/-5%) of nominal flow. Many TeeJet nozzle types and sizes are already JKI-approved, which confirms the high quality standard designed into TeeJet nozzles. To maintain the quality in practical spraying as long as possible, the operator's job is the proper maintenance of those spray tips.

The illustration below compares the spraying results obtained from well-maintained vs. poorly-maintained spray tips. Poor spray distribution can be prevented. Selection of longer wearing tip materials or frequent replacement of tips from softer materials can eliminate misapplication due to worn spray tips.

Careful cleaning of a clogged spray tip can mean the difference between a clean field and one with weed streaks. Flat spray tips have finely crafted thin edges around the orifice to control the spray. Even the slightest damage from improper cleaning can cause both an increased flow rate and poor spray distribution. Be sure to use adequate strainers in your spray system to minimize clogging. If a tip does clog, only use a soft bristled brush or toothpick to clean it—never use a metal object. Use extreme care with soft tip materials such as plastic. Experience has shown that even a wooden toothpick can distort the orifice.

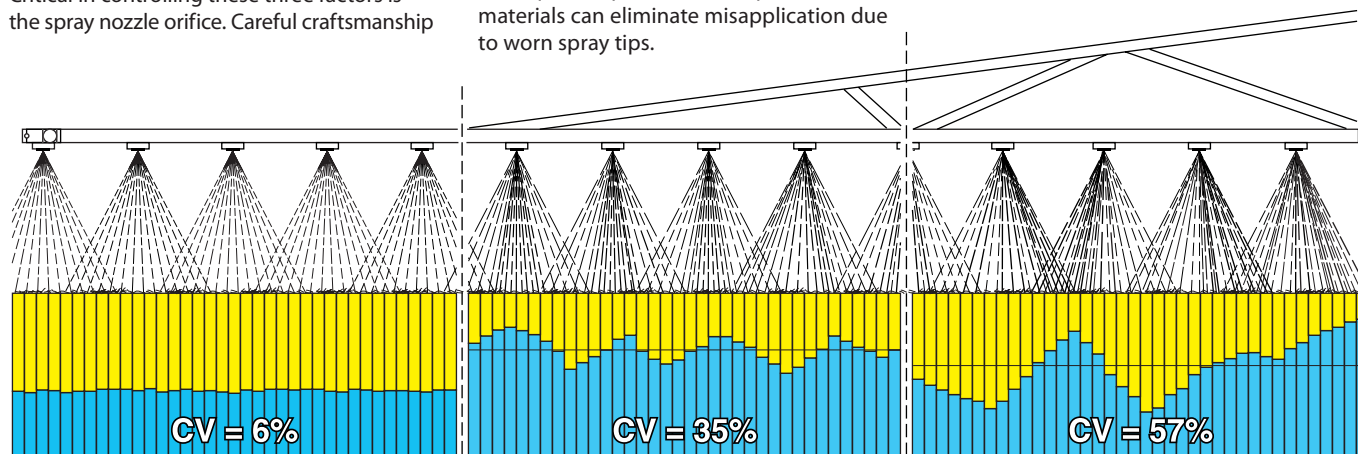

NEW SPRAY TIPS

Produce a uniform distribution when properly overlapped.

WORN SPRAY TIPS

Have a higher output with more spray concentrated under each tip.

DAMAGED SPRAY TIPS

Have a very erratic output – overapplying and underapplying.

Spray Distribution Quality

One of the most overlooked factors that can dramatically influence the effectiveness of a given crop production chemical is spray distribution. The uniformity of the spray distribution across the boom or within the spray swath is an essential component to achieving maximum chemical effectiveness with minimal cost and minimal non-target contamination. This is more than critical if carrier and chemical rates are applied at the recommended minimum rate. There are many other factors influencing a crop production chemical's effectiveness, such as weather, application timing, active ingredient rates, pest infestation, etc. However, an operator must become aware of spray distribution quality if maximum efficiency is expected.

Measurement Techniques

Spray distribution can be measured in different ways. TeeJet Technologies and some sprayer manufacturers, as well as other research and testing stations, have patternators (spray tables) that collect the spray from nozzles on a standardized or real boom. These patternators have a number of channels aligned perpendicular to the nozzle spray. The channels carry the spray liquid into vessels for measuring and analysis (see photo with TeeJet patternator). Under controlled conditions, very accurate distribution measurements can be made for nozzle evaluation and development. Distribution measurements can also take place on an actual farm sprayer. For static measurements along the sprayer boom, a patternator equal or very similar to the one described earlier is placed under the boom in

a stationary position or as a small patternator unit scanning the whole boom up to a width of 50 m. Any system of patternator measures electronically the quantity of water in each channel and calculates the values. A distribution quality test gives the applicator important information about the state of the nozzles on the boom. When much more detailed information about spray quality and coverage is required, a dynamic system—spraying a tracer (dye)—can be used. The same is true if the distribution within the swath on a boom has to be measured. Currently, only a few test units worldwide have the ability to perform a stationary test. These tests usually involve shaking or moving the spray boom to simulate actual field and application conditions.

Most of the distribution measuring devices result in data points representing the sprayer's boom swath uniformity. These data points can be very revealing just through visual observation. However, for comparison reasons, a statistical method is widely accepted. This method is Coefficient of Variation (Cv). The Cv compiles all the patternator data points and summarizes them into a simple percentage, indicating the amount of variation within a given distribution. For extremely uniform distributions under accurate conditions, the Cv can be $\leq 7\%$. In some European countries, nozzles must conform to very strict Cv specifications, while other countries may require the sprayer's distribution to be tested for uniformity every one or two years. These types of stipulations emphasize the great importance of distribution quality and its effect on crop production effectiveness.

Factors Affecting Distribution

There are a number of factors contributing to the distribution quality of a spray boom or resulting Cv percentage. During a static measurement, the following factors can significantly affect the distribution.

- Nozzles
 - type
 - pressure
 - spacing
 - spray angle
 - offset angle
 - spray pattern quality
 - flow rate
 - overlap
- Boom Height
- Worn Nozzles
- Pressure Losses
- Plugged Filters
- Plugged Nozzles
- Plumbing Factors Influencing Liquid Turbulence at Nozzle

Additionally, in the field during the spraying application or during a dynamic distribution test, the following can influence the distribution quality:

- Boom Stability
 - vertical movement (pitch)
 - horizontal movement (yaw)
- Environmental Conditions
 - wind velocity
 - wind direction
- Pressure Losses (sprayer plumbing)
- Sprayer Speed and Resulting Turbulence

The effect of distribution uniformity on the efficiency of a crop production chemical can vary under different circumstances. The crop production chemical itself can have dramatic influence over its efficiency. Always consult the manufacturer's chemical label or recommendation before spraying.

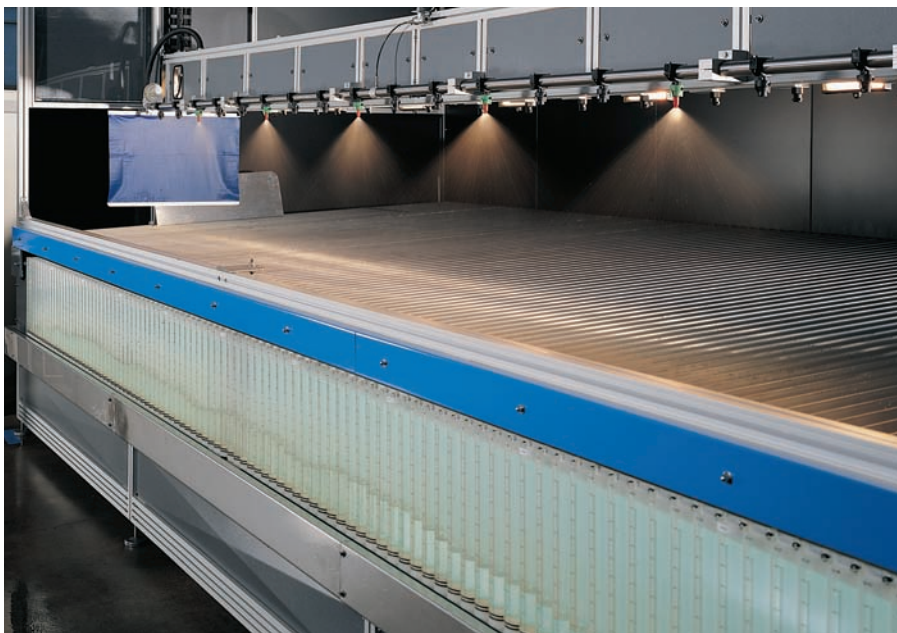

Droplet Size and Drift Information

A nozzle's spray pattern is made up of numerous spray droplets of varying sizes. Droplet size refers to the diameter of an individual spray droplet.

Since most nozzles have a wide distribution of droplet sizes (otherwise known as droplet spectrum), it is useful to summarize this with statistical analysis. Most advanced drop size measuring devices are automated, using computers and high-speed illumination sources such as lasers to analyze thousands of droplets in a few seconds. Through statistics, this large volume of data can be reduced to a single number that is representative of the drop sizes contained in the spray pattern and can then be classified into droplet size classes. These classes (extremely fine, very fine, fine, medium,

coarse, very coarse, extremely coarse and ultra coarse) can then be used to compare one nozzle to another. Care must be taken when comparing one nozzle's drop size to another, as the specific testing procedure and instrument can bias the comparison.

Droplet sizes are usually measured in microns (micrometers). One micron equals 0.001 mm. The micron is a useful unit of measurement because it is small enough that whole numbers can be used in drop size measurement.

The majority of agricultural nozzles can be classified as producing either fine, medium, coarse or very coarse droplets. A nozzle with a coarse or very coarse droplet is usually selected to minimize off-target spray drift, while a nozzle with a fine droplet

is required to obtain maximum surface coverage of the target plant.

To show comparisons between nozzle types, spray angle, pressure and flow rate, refer to the droplet size classes shown in the tables on pages 152–155.

Another droplet size measurement that is useful for determining a nozzle's drift potential is the percentage of driftable fines. Since the smaller droplets have a greater tendency to move off-target, it makes sense to determine what the percentage of small droplets is for a particular nozzle in order to minimize it when drift is a concern. Droplets below 150 microns are considered potential drift contributors. The table below shows several nozzles and their percentage of driftable fines.

TeeJet Technologies uses the most advanced measuring instrumentation (PDPA and Oxford lasers) to characterize sprays, obtaining droplet size and other important information. For the latest accurate information about nozzles and their droplet size, please contact your nearest TeeJet representative.



Driftable Droplets*

NOZZLE TYPE (0.50 GPM FLOW)	APPROXIMATE PERCENT OF SPRAY VOLUME LESS THAN 150 MICRONS	
	15 PSI	40 PSI
XR – Extended Range TeeJet (110°)	19%	30%
TT – Turbo TeeJet (110°)	4%	13%
TTJ60 – Turbo TwinJet (110°)	3%	10%
TF – Turbo FloodJet	2%	7%
AIXR – Air Induction XR (110°)	2%	7%
AITTJ60 – Air Induction Turbo TwinJet (110°)	1%	6%
AI – Air Induction TeeJet (110°)	N/A	5%
TTI – Turbo TeeJet Induction (110°)	<1%	2%

*Data obtained from Oxford VisiSizer system spraying water at 70°F (21°C) under laboratory conditions.



Assessment of Nozzle Drift Control in Europe

Several European countries now consider it important to assess nozzles for spray drift control as this enables general cooperation between agriculture, nature conservation and environmental protection. Although spray pattern distribution testing has been carried out for several decades (see page 147), preliminary assessment criteria for drift control during chemical applications were first defined in the 1980's and 1990's. A minimum value was determined for the small droplet ratio ($D_{v0.1}$) of nozzles. The development of the XR TeeJet® nozzles, together with the first generation of drift control nozzles (DG TeeJet®), achieved significant advances in crop protection technology. However, these proved insufficient as environmental regulations on chemical application became more and more restrictive. Stricter requirements for buffer strips to protect surface water and sensitive areas around fields in particular have led to the development of a program that assesses nozzle drift control as well as to innovative nozzles producing larger droplet sizes. While nozzle development is described on pages 150 and 151, priority here is given to describing drift control evaluation programs.

Drift control assessment systems in Europe

Countries such as the UK, the Netherlands and Germany do not use standardized systems for measuring reduction in drift. However, one aspect shared by all systems is they all use a reference system based on the 03 nozzle specified in the BCPC droplet size classification scheme at 43.5 PSI (3 bar) pressure and at a spray height of 19.7" (50 cm) above the target surface. Drift from this nozzle is defined as 100%. The drift control levels from other nozzle types at the same pressure are compared with this reference nozzle. For example, a nozzle categorized as 50% produces at least 50% less drift than the reference nozzle. The countries mentioned above have compiled corresponding percentage drift control categories, which vary from one another in some areas and are valid only at a national level.

While in Germany drift control categories of 50% / 75% / 90% / 99% apply, they are categorized as 50% / 75% / 90% / 95% in the Netherlands and as 25% / 50% / 75% in the UK. Furthermore, the same nozzle type and size operated at the same pressure may be categorized as 50% in country A and 75% in country B. This is due to different methods of measurement and calculation. The future may lead to international standardization emerging over the next few years as a result of approaching EU harmonization. At present, TeeJet Technologies is obliged to test new developments and have them assessed in each of these countries to verify the effectiveness of the technical advances so farmers can use our products without fearing conflict with the government.

The system in Germany

In Germany, the Julius Kühn Institute-Federal Research Institute for Cultivated Plants (JKI), is responsible for testing nozzles for agricultural use. Drift measurements are taken in the field under the most standardized conditions possible for temperature, wind direction, wind velocity and forward speed. This method is mandatory for testing air-assisted sprayers and their affect on nozzles used on permanent crops such as orchards and vineyards. Thanks to field measurements recorded over many years and their high correlation with temperature-controlled wind tunnel measurements, drift measurements on agricultural nozzles can now also be conducted at the JKI wind tunnel in absolutely standardized conditions. In all cases, tracer methods are used to quantify droplets of a high detection limit on artificial collectors and feed the data into a "DIX model" (drift potential index). This gives DIX values expressed as categories in the percentage drift reduction classes.

The system in the UK

The UK currently uses only one assessment system for agricultural nozzles. The Pesticide Safety Directorate (PSD) evaluates data recorded in the wind tunnel, but in contrast to the JKI, it records the droplets landed on horizontal collectors. The climatic conditions are standardized as well. The test nozzle is compared with the BCPC reference nozzle and awarded a corresponding star rating where one

star equates to drift levels up to 75%, two stars up to 50% and three stars up to 25% of those of the reference system.

The system in the Netherlands

Although the Dutch have used an assessment system for agricultural nozzles for several years (Lozingenbesluit Open Teelten Veehouderij/Water Pollution Act, Sustainable Crop Protection), they are about to introduce a system for nozzles used in orchard spraying. Agrotechnology & Food Innovations B.V. (WageningenUR) is in charge of the measurements. A Phase Doppler Particle Analyzer (PDPA laser) is used to investigate the droplets and droplet speed from a nozzle offering the following characteristics: $D_{v0.1}$, VMD, $D_{v0.9}$ and volume fraction <100µm. The data collected is then fed into the IDEFICS model. The calculation also factors in a reference crop and stage, a buffer strip in the field, forward speed and defined weather conditions to arrive at a percentage nozzle classification for the particular spray pressure under examination. Approval bodies such as CTB (75% / 90% / 95%) and RIZA (50%) publish the classifications.

Benefits and options for users

The use of drift control nozzles brings significant benefits to users in the countries listed, as well as others around the world. Depending on the location of the fields relative to environmentally sensitive areas such as surface water and field boundaries, applicators can reduce the width of buffer strips, as stipulated by the relevant restrictions in association with the approval of the chemical (e.g. 20 meter no-spray buffer strips). Consequently, it is possible to apply chemicals subject to restrictions in field margins near surface water etc., provided that the user complies with the national application regulations. If the directions of use for a particular product require a 75% reduction of drift, allowing for carrier volume and travel speed, it will be necessary to use a nozzle with a 75% drift control classification and operate it at the spray pressure specified. As a general rule, forward speed can be optimized so that the same nozzle can be used near the field boundaries as well as within the middle of the applied field area. With this, the carrier volume remains constant in different situations. Since it is possible to define minimum buffer strip widths for all applications at a national level as well, these must always be considered on a case by case basis.

In general, for successful crop protection, it is necessary to select nozzles of a high percentage classification (75% or higher) only in those situations where statutory buffer strip requirements apply. Otherwise, we suggest using nozzles at a spray pressure achieving a 50% drift control or using non-classified nozzles.

For further information about the low-drift categories of TeeJet nozzles, contact your TeeJet representative or go to www.teejet.com.



Drift Causes and Control



Figure 1. This is not what crop protection should look like!

When applying crop protection chemicals, spray drift is a term used for those droplets containing the active ingredients that are not deposited on the target area. The droplets most prone to spray drift are usually small in size, less than 150 micron in diameter and easily moved off the target area by wind or other climatic conditions. Drift can cause crop protection chemicals to be deposited in undesirable areas with serious consequences, such as:

- Damage to sensitive adjoining crops.
- Surface water contamination.
- Health risks for animals and people.
- Possible contamination to the target area and adjacent areas or possible over-application within the target area.

Causes of Spray Drift

A number of variables contribute to spray drift; these are predominantly due to the spray equipment system and meteorological factors.

■ Droplet Size

Within the spray equipment system, drop size is the most influential factor related to drift.

When a liquid solution is sprayed under pressure it is atomized into droplets of varying sizes: **The smaller the nozzle size and the greater the spray pressure, the smaller the droplets and therefore the greater the proportion of driftable droplets.**

■ Spray Height

As the distance between the nozzle and the target area increases, the greater impact wind velocity can have on drift. The influence of wind can increase the proportion of smaller drops being carried off target and considered drift.

Do not spray at greater heights than those recommended by the spray tip manufacturer, while taking care not to spray below the minimum recommended heights.

■ Operating Speed

Increased operating speeds can cause the spray to be diverted back into upward wind currents and vortices behind the sprayer, which trap small droplets and can contribute to drift.

Apply crop protection chemicals according to good, professional practices at maximum operating speeds of 4 to 6 mph (with air induction type nozzles—up to 6 mph). As wind velocities increase, reduce operating speed.*

* Liquid fertilizer applications using the TeeJet® tips with very coarse droplets can be performed at higher operating speeds.

■ Wind Velocity

Among the meteorological factors affecting drift, wind velocity has the greatest impact. Increased wind speeds cause increased spray drift. It is common knowledge that in most parts of the world the wind velocity is variable throughout the day (see Figure 2). Therefore, it is important for spraying to take place during the relatively calm hours of the day. The early morning and early evening are usually the most calm. **Refer to chemical label for velocity recommendations.**

When spraying with traditional techniques the following rules-of-thumb apply:

In low wind velocity situations, spraying can be performed at recommended nozzle pressures.

As wind velocities increase up to 17 mph, spray pressure should be reduced and nozzle size increased to obtain larger droplets that are less prone to drift. Wind measurements should be taken throughout the spraying operation with a wind meter or anemometer. As the risk of spray drift increases, selecting designed to more coarse droplets that are less prone to drift is extremely important. Some such TeeJet nozzles that fit into this category are: DG TeeJet®, Turbo TeeJet®, AI TeeJet®, Turbo TeeJet Induction, and AIXR TeeJet.

When wind velocities exceed 11 MPH (5 m/s), spraying operation should not be performed.

■ Air Temperature and Humidity

In ambient temperatures over 77°F/25°C with low relative humidity, small droplets are especially prone to drift due to the effects of evaporation.

High temperature during the spraying application may necessitate system changes, such as nozzles that produce a coarser droplet or suspending spraying.

■ Crop Protection Chemicals and Carrier Volumes

Before applying crop protection chemicals, the applicator should read and follow all instructions provided by the manufacturer. Since extremely low carrier volume usually necessitates the use of small nozzle sizes, the drift potential is increased. As high a carrier volume as practical is recommended.

Application Regulations for Spray Drift Control

In several European countries, regulatory authorities have issued application regulations in the use of crop protection chemicals to protect the environment. In order to protect the surface waters and the field buffer areas (examples are: hedges and grassy areas of a certain width) distance requirements must be kept because of spray drift. Inside the European Union (EU) there is a directive for the harmonization of crop protection chemicals in regards to environmental protection. In this respect the procedures that have been implemented in Germany, England and the Netherlands will be established in other EU countries in the coming years.

To reach the objectives for environmental protection, spray drift reducing measures have been integrated as a central instrument in the practice of risk evaluation. For example, buffer zones may be reduced in width if certain spraying techniques or equipment is used that have been approved and certified by certain regulatory agencies. Many of the TeeJet nozzles designed for reducing spray drift have been approved and certified in several EU countries. The certification of those registrars fits into a drift reduction category, such as 90%, 75%, or 50% (90/75/50) control of drift (see page 149). This rating is related to the comparison of the BCPC reference nozzle capacity of 03 at 3 bar.

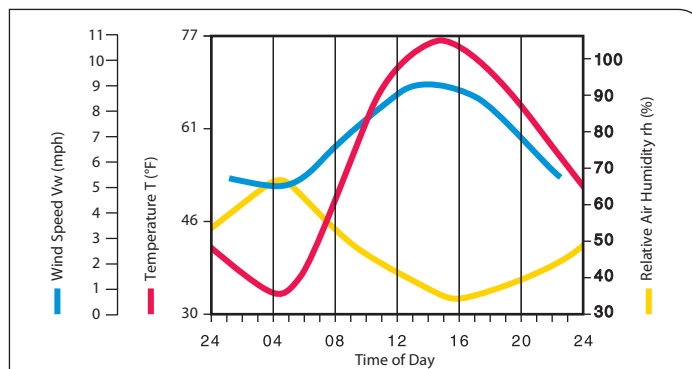

Figure 2. Development of wind velocity, air temperature and relative air humidity (example). From: Malberg

Nozzles for Spray Drift Control

Drift potential can be minimized even when it is necessary to use small nozzle capacities by selecting nozzle types that produce larger Volume Median Diameter (VMD) droplets and a lower percentage of small droplets. Figure 4 is an example showing VMD's produced by nozzles of identical flow rates (size 11003) which produce coarser droplets than an XR TeeJet and then larger droplets in sequence; TT/TTJ60, AIXR, AITTJ60, AI and TTI. TTI nozzles produce the coarsest droplet size spectrum of this group. When operating at a pressure of 50 PSI (3 bar) and 5 MPH (7 km/h) ground speed, the application rate is 20 GPA (200 l/ha). At the same time, the observation is that the VMD increases significantly from the XR to the TTI. This shows that it is possible to cover the entire droplet size spectrum from very fine to extremely coarse droplets by using different types of nozzles. While susceptibility to drift decreases when droplets become larger, the number of droplets available may lead to less uniform coverage. To compensate for this drawback and for the chemical to be effective, it is necessary to apply the optimum pressure range specified for a particular type of nozzle. If applicators comply with the parameters set by the manufacturers, they will always cover 10–15% of the target surface on average, which is not least attributed to the fact that less drift translates into more effective

coverage. Figure 4 shows the VMD curves by nozzle type indicating the optimum pressure ranges for the individual nozzles which should be selected with respect to both effective drift control and effect of the chemical. When the focus is on drift control, TT, TTJ60 and AIXR are operated at pressures of less than 29.5 PSI (2 bar). Yet, where maximum effect is critical, the nozzles are operated at pressures between 29.5 PSI (2 bar) and 52 PSI (3.5 bar) or even higher in specific conditions. These pressure ranges do not apply to AI and TTI, which operate at less than 43.5 PSI (3 bar) when drift control is critical and always at 58 PSI (4 bar) and 101.5 PSI (7 bar) and even 116 PSI (8 bar) when the emphasis is on chemical affect. Therefore, for applicators to select the correct nozzle size it is necessary to consider the spray pressure at which a chemical is most effective. With this, they simply have to reduce pressure and ground speed to comply with statutory buffer strip requirements. It is down to the conditions prevailing at the individual farm (location of the field, number of water bodies, type of chemical applied, etc.) whether they should choose a TeeJet nozzle that reduces drift by 50%, 75% or 90%. On principle, applicators should use 75% or 90% drift control nozzles (extremely coarse droplets) only when spraying near field boundaries and 50% or less TeeJet nozzles in all other areas of the field.

While the classic XR TeeJet orifice provides two functions; metering the volume flow rate and distributing and creating the droplets, all other nozzle types discussed above use a pre-orifice for metering while distribution and droplet creation takes place at the exit orifice (Fig. 3). Both functions and devices relate to each other with respect to geometry and spacing and interact with respect to the droplet size produced. The TT, TTJ60, AITTJ60 and TTI nozzles force the

liquid to change direction after it has passed the pre-orifice, forcing it into a horizontal chamber and to change direction again into the nearly vertical passage in the orifice itself. The AI, AITTJ60, AIXR and TTI air induction nozzles operate on the Venturi principle, where the pre-orifice generates a higher-velocity stream, aspirating air through the side holes. This specific air/liquid mix creates more coarse droplets that are filled with air, depending on the chemical used.

Summary

Successful drift management centers on sound knowledge about drift contributing factors and the use of drift control, TeeJet nozzles. To strike a sound balance between successful chemical application and environmental protection, applicators should use approved broadcast TeeJet nozzles that are classified as drift control and operate these within the pressure ranges that ensure chemical effectiveness; i.e. set nozzles to 50% drift control or less. The following list shows all the relevant factors that need to be considered, optimized or applied to achieve effective drift control:

- Low-Drift TeeJet nozzles
- Spraying pressure and droplet size
- Application rate and nozzle size
- Spraying height
- Forward speed
- Wind velocity
- Ambient temperature and relative humidity
- Buffer strips (or apply options that allow reducing the width of buffer strips)
- Compliance with manufacturer instructions

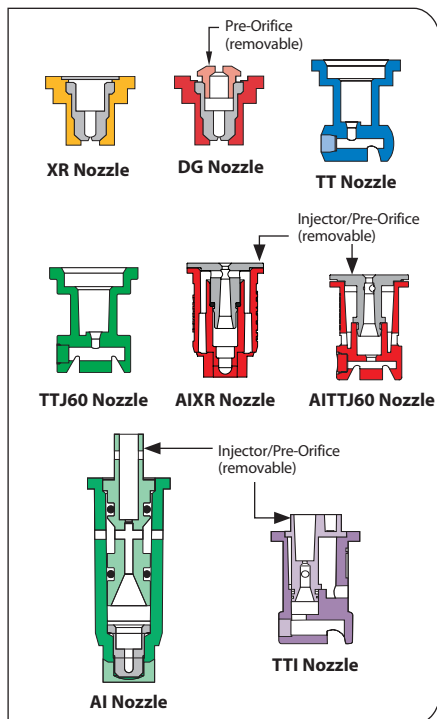

Figure 3: XR, DG, TT, AIXR, AI, AITTJ60, TTJ60 and TTI nozzles (sectional drawings).

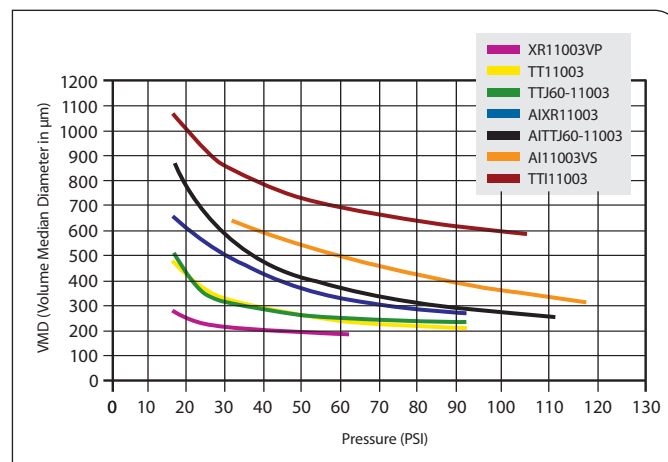

Figure 4. Volumetric droplet diameters of XR, TT, TTJ60, AIXR, AI, AITTJ60 and TTI nozzles relative to pressure

Measurement conditions:
 – Continuous Oxford Laser measurement across the full width of the flat spray
 – Water temperature 70 °F

$$A = \frac{B+C}{D}$$

Drop Size Classification

Nozzle selection is often based upon droplet size. The droplet size from a nozzle becomes very important when the efficacy of a particular plant protection chemical is dependent on coverage, or the prevention of spray leaving the target area is a priority.

The majority of the nozzles used in agriculture can be classified as producing droplets in the range of fine to ultra coarse droplets. Nozzles that produce droplets in the finer to middle portion of the range are usually recommended for post-emergence contact applications, which require excellent coverage on the intended target area. This may include herbicides, insecticides and fungicides. Nozzles producing droplets from the middle to coarser end of the range, while offering less thorough

surface coverage, provide significantly improved drift control. These nozzles are commonly used for systemic and pre-emergence surface applied herbicides.

An important point to remember when choosing a spray nozzle that produces a droplet size in one of the eight categories is that one nozzle can produce different droplet size classifications at different pressures.

A nozzle might produce medium droplets at low pressures, while producing fine droplets as pressure is increased.

Droplet size classes are shown in the following tables to assist in choosing an appropriate spray tip.

Category	Symbol	Color Code
Extremely Fine	XF	
Very Fine	VF	
Fine	F	
Medium	M	
Coarse	C	
Very Coarse	VC	
Extremely Coarse	XC	
Ultra Coarse	UC	

Droplet size classifications are based on BCPC specifications and in accordance with ASABE Standard S572.1 at the date of printing. Classifications are subject to change.

AI TeeJet® (AI)

	PSI										
	30	35	40	45	50	55	60	70	80	90	100
AI80015	UC	UC	XC	XC	XC	XC	XC	VC	VC	VC	C
AI8002	UC	UC	XC	XC	XC	XC	XC	VC	VC	VC	C
AI80025	UC	UC	XC	XC	XC	XC	XC	VC	VC	VC	VC
AI8003	UC	UC	XC	XC	XC	XC	XC	VC	VC	VC	VC
AI81004	UC	UC	XC	XC	XC	XC	XC	VC	VC	VC	C
AI8005	UC	UC	UC	XC	XC	XC	XC	XC	VC	VC	VC
AI8006	UC	UC	UC	UC	UC	XC	XC	XC	XC	XC	XC
AI110015	UC	XC	XC	XC	XC	XC	VC	VC	VC	C	C
AI11002	UC	UC	XC	XC	XC	XC	VC	VC	VC	VC	C
AI110025	UC	UC	XC	XC	XC	XC	VC	VC	VC	C	C
AI11003	UC	UC	XC	XC	XC	XC	VC	VC	VC	C	C
AI11004	UC	UC	XC	XC	XC	XC	VC	VC	VC	C	C
AI11005	UC	UC	XC	XC	XC	XC	VC	VC	VC	VC	VC
AI11006	UC	UC	UC	XC	XC	XC	XC	VC	VC	VC	VC
AI11008	UC	UC	UC	UC	XC	XC	XC	VC	VC	VC	VC

AI TeeJet® (AI E)

	PSI							
	30	40	50	60	70	80	90	100
AI95015E	UC	XC	XC	VC	VC	VC	C	C
AI9502E	UC	XC	XC	VC	VC	VC	VC	C
AI95025E	UC	XC	XC	VC	VC	VC	VC	C
AI9503E	UC	XC	XC	VC	VC	VC	VC	C
AI9504E	UC	XC	XC	VC	VC	VC	VC	C
AI9505E	UC	XC	XC	VC	VC	VC	VC	VC
AI9506E	UC	UC	XC	XC	XC	VC	VC	VC
AI9508E	UC	UC	XC	XC	XC	VC	VC	VC

AI3070 TeeJet® (AI3070)

	PSI							
	20	30	40	50	60	70	80	90
AI3070-015	VC	C	C	M	M	M	M	F
AI3070-02	XC	VC	C	C	C	M	M	M
AI3070-025	XC	VC	C	C	C	C	C	M
AI3070-03	XC	XC	VC	C	C	C	C	C
AI3070-04	UC	XC	VC	VC	VC	C	C	C
AI3070-05	UC	XC	VC	VC	VC	C	C	C

AIC TeeJet® (AIC)

	PSI										
	30	35	40	45	50	55	60	70	80	90	100
AIC110015	UC	XC	XC	XC	XC	XC	VC	VC	VC	C	C
AIC11002	UC	UC	XC	XC	XC	XC	VC	VC	VC	VC	C
AIC110025	UC	UC	XC	XC	XC	XC	XC	VC	VC	VC	C
AIC11003	UC	UC	XC	XC	XC	XC	XC	VC	VC	VC	C
AIC11004	UC	UC	XC	XC	XC	XC	XC	VC	VC	VC	C
AIC11005	UC	UC	XC	XC	XC	XC	XC	VC	VC	VC	VC
AIC11006	UC	UC	UC	XC	XC	XC	XC	XC	VC	VC	VC
AIC11008	UC	UC	UC	UC	XC	XC	XC	XC	VC	VC	VC
AIC11010	UC	UC	UC	UC	XC	XC	XC	XC	XC	VC	VC
AIC11015	UC	UC	UC	UC	XC	XC	XC	XC	XC	VC	VC

AIUB TeeJet® (AIUB)

	PSI							
	30	40	50	60	70	80	90	100
AIUB8502	UC	XC	XC	VC	VC	VC	VC	C
AIUB85025	UC	XC	XC	XC	VC	VC	VC	C
AIUB8503	UC	XC	XC	XC	VC	VC	VC	C
AIUB8504	UC	XC	XC	XC	VC	VC	VC	C

Air Induction Turbo TwinJet® (AITTJ60)

	PSI										
	20	25	30	35	40	50	60	70	80	90	100
AITTJ60-11002	XC	XC	VC	VC	VC	C	C	C	C	C	M
AITTJ60-110025	XC	XC	VC	VC	VC	C	C	C	C	C	M
AITTJ60-11003	UC	XC	XC	XC	VC	VC	C	C	C	C	C
AITTJ60-11004	UC	XC	XC	XC	VC	VC	C	C	C	C	C
AITTJ60-11005	UC	XC	XC	XC	XC	VC	VC	C	C	C	C
AITTJ60-11006	UC	XC	XC	XC	XC	VC	VC	C	C	C	C
AITTJ60-11008	UC	UC	UC	UC	XC	XC	VC	VC	VC	C	C
AITTJ60-11010	UC	UC	UC	UC	UC	XC	XC	XC	XC	VC	VC
AITTJ60-11015	UC	UC	UC	UC	UC	XC	XC	XC	XC	VC	VC

AIXR TeeJet® (AIXR)

	PSI										
	15	20	25	30	35	40	50	60	70	75	90
AIXR110015	XC	XC	VC	C	C	C	C	M	M	M	M
AIXR11002	XC	XC	XC	VC	VC	C	C	C	C	M	M
AIXR110025	XC	XC	XC	XC	VC	VC	C	C	C	C	C
AIXR11003	XC	XC	XC	XC	VC	VC	C	C	C	C	C
AIXR11004	UC	XC	XC	XC	XC	XC	VC	VC	C	C	C
AIXR11005	UC	XC	XC	XC	XC	XC	VC	VC	C	C	C
AIXR11006	UC	XC	XC	XC	XC	XC	VC	VC	VC	C	C

DG TwinJet® (DGTJ60)

	PSI				
	30	35	40	50	60
DGTJ60-110015	F	F	F	F	F
DGTJ60-11002	M	M	M	F	F
DGTJ60-11003	M	M	M	F	F
DGTJ60-11004	C	C	C	C	M
DGTJ60-11006	C	C	C	C	C
DGTJ60-11008	C	C	C	C	C

DG TeeJet (DG)

	PSI				
	30	35	40	50	60
DG80015	M	M	M	M	F
DG8002	M	M	M	M	M
DG8003	C	M	M	M	M
DG8004	C	C	C	M	M
DG8005	C	C	C	M	M
DG110015	M	M	F	F	F
DG11002	M	M	M	M	M
DG11003	C	M	M	M	M
DG11004	C	C	M	M	M
DG11005	C	C	C	M	M

TeeJet® (TP)

	PSI				
	30	35	40	50	60
TP8001	F	F	F	F	F
TP80015	F	F	F	F	F
TP8002	F	F	F	F	F
TP8003	F	F	F	F	F
TP8004	M	M	M	F	F
TP8005	M	M	M	M	F
TP8006	M	M	M	M	M
TP8008	C	C	M	M	M
TP11001	F	F	F	F	VF
TP110015	F	F	F	F	F
TP11002	F	F	F	F	F
TP11003	F	F	F	F	F
TP11004	M	M	M	F	F
TP11005	M	M	M	F	F
TP11006	M	M	M	M	F
TP11008	C	M	M	M	M

AITX ConeJet® (AITXA & AITXB)

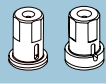
	PSI							
	60	80	100	120	140	160	180	200
AITXA8001 AITXB8001	XC	VC	VC	C	C	C	C	C
AITXA80015 AITXB80015	XC	XC	VC	C	C	C	C	C
AITXA8002 AITXB8002	XC	XC	XC	VC	VC	VC	VC	C
AITXA80025 AITXB80025	UC	XC	XC	XC	XC	XC	VC	VC
AITXA8003 AITXB8003	UC	XC	XC	XC	XC	VC	VC	VC
AITXA8004 AITXB8004	UC	UC	XC	XC	XC	XC	XC	VC

DG TeeJet® (DG E)

	PSI				
	30	35	40	50	60
DG95015E	M	M	M	F	F
DG9502E	M	M	M	M	M
DG9503E	C	M	M	M	M
DG9504E	C	C	C	M	M
DG9505E	C	C	C	M	M

Turbo FloodJet® (TF)

	PSI				
	10	20	30	40	50
TF-2	UC	XC	XC	VC	VC
TF-2.5	UC	UC	XC	XC	VC
TF-3	UC	UC	XC	XC	VC
TF-4	UC	UC	XC	XC	XC
TF-5	UC	UC	UC	XC	XC
TF-7.5	UC	UC	UC	XC	XC
TF-10	UC	UC	UC	XC	XC

Turbo TeeJet® (TT)

	PSI										
	15	20	25	30	35	40	50	60	70	80	90
TT11001	C	C	M	M	M	M	M	F	F	F	F
TT110015	VC	C	C	M	M	M	M	F	F	F	F
TT11002	VC	VC	C	C	M	M	M	M	F	F	F
TT110025	VC	VC	C	C	M	M	M	M	F	F	F
TT11003	VC	VC	C	C	C	C	M	M	M	M	F
TT11004	XC	VC	VC	C	C	C	M	M	M	M	M
TT11005	XC	VC	VC	VC	VC	C	C	M	M	M	M
TT11006	XC	VC	VC	VC	VC	VC	C	C	C	M	M
TT11008	XC	VC	VC	VC	VC	C	C	C	C	M	M

$$A = \frac{B+C}{D}$$

Drop Size Classification

Turbo TeeJet® Induction (TTI)

	PSI											
	15	20	25	30	35	40	50	60	70	80	90	100
TTI110015	UC	UC	UC	UC	UC	UC	UC	XC	XC	XC	XC	XC
TTI11002	UC	UC	UC	UC	UC	UC	UC	UC	XC	XC	XC	XC
TTI110025	UC	UC	UC	UC	UC	UC	UC	UC	XC	XC	XC	XC
TTI11003	UC	UC	UC	UC	UC	UC	UC	UC	XC	XC	XC	XC
TTI11004	UC	UC	UC	UC	UC	UC	UC	UC	XC	XC	XC	XC
TTI11005	UC	UC	UC	UC	UC	UC	UC	UC	XC	XC	XC	XC
TTI11006	UC	UC	UC	UC	UC	UC	UC	UC	XC	XC	XC	XC

Turbo TwinJet® (TTJ60)

	PSI									
	20	25	30	35	40	50	60	70	80	90
TTJ60-11002	C	C	C	C	C	M	M	M	M	M
TTJ60-110025	VC	C	C	C	C	C	C	M	M	M
TTJ60-11003	VC	C	C	C	C	C	C	C	M	M
TTJ60-11004	VC	C	C	C	C	C	C	C	C	M
TTJ60-11005	VC	C	C	C	C	C	C	C	C	C
TTJ60-11006	XC	VC	VC	C	C	C	C	C	C	C

TurfJet (TTJ)

	PSI						
	25	30	40	50	60	70	75
1/4TTJ02	UC	UC	UC	XC	XC	XC	XC
1/4TTJ04	UC	UC	UC	UC	UC	UC	UC
1/4TTJ05	UC	UC	UC	UC	UC	UC	UC
1/4TTJ06	UC	UC	UC	UC	UC	UC	UC
1/4TTJ08	UC	UC	UC	UC	UC	UC	UC
1/4TTJ10	UC	UC	UC	UC	UC	UC	UC
1/4TTJ15	UC	UC	UC	UC	UC	UC	UC

TwinJet® (TJ60)

	PSI				
	30	35	40	50	60
TJ60-6501	F	VF	VF	VF	VF
TJ60-650134	F	F	F	VF	VF
TJ60-6502	F	F	F	F	F
TJ60-6503	M	F	F	F	F
TJ60-6504	M	M	M	M	F
TJ60-6506	M	M	M	M	M
TJ60-6508	C	C	C	M	M
TJ60-8001	VF	VF	VF	VF	VF
TJ60-8002	F	F	F	F	F
TJ60-8003	F	F	F	F	F
TJ60-8004	M	M	F	F	F
TJ60-8005	M	M	M	F	F
TJ60-8006	M	M	M	M	M
TJ60-8008	C	M	M	M	M
TJ60-8010	C	C	C	M	M
TJ60-11002	F	VF	VF	VF	VF
TJ60-11003	F	F	F	F	F
TJ60-11004	F	F	F	F	F
TJ60-11005	M	M	M	F	F
TJ60-11006	M	M	M	F	F
TJ60-11008	M	M	M	M	M
TJ60-11010	M	M	M	M	M

TwinJet® (TJ60 E)

	PSI			
	30	40	50	60
TJ60-8002E	F	F	F	F
TJ60-8003E	F	F	F	F
TJ60-8004E	M	F	F	F
TJ60-8006E	M	M	M	M

TX ConeJet® (TXA & TXB)

	PSI							
	30	40	50	60	70	80	90	100
TXA800050 TXB800050	F	VF	VF	VF	VF	VF	VF	VF
TXA800067 TXB800067	F	VF	VF	VF	VF	VF	VF	VF
TXA8001 TXB8001	F	F	VF	VF	VF	VF	VF	VF
TXA80015 TXB80015	F	F	F	F	F	VF	VF	VF
TXA8002 TXB8002	F	F	F	F	VF	VF	VF	VF
TXA8003 TXB8003	F	F	F	F	F	F	VF	VF
TXA8004 TXB8004	F	F	F	F	F	F	VF	VF

TX ConeJet® (TX)

	PSI							
	30	40	50	60	70	80	90	100
TX-1	VF	VF	VF	VF	VF	VF	VF	VF
TX-2	VF	VF	VF	VF	VF	VF	VF	VF
TX-3	F	VF	VF	VF	VF	VF	VF	VF
TX-4	F	VF	VF	VF	VF	VF	VF	VF
TX-6	F	F	VF	VF	VF	VF	VF	VF
TX-8	F	F	VF	VF	VF	VF	VF	VF
TX-10	F	F	F	F	VF	VF	VF	VF
TX-12	F	F	F	F	VF	VF	VF	VF
TX-18	F	F	F	F	F	F	VF	VF
TX-26	F	F	F	F	F	F	VF	VF

TXR ConeJet® (TXR)

	PSI							
	30	40	50	60	70	80	90	100
TXR800053	VF	VF	VF	VF	VF	VF	VF	VF
TXR800071	F	VF	VF	VF	VF	VF	VF	VF
TXR80001	F	F	VF	VF	VF	VF	VF	VF
TXR80013	F	F	VF	VF	VF	VF	VF	VF
TXR80015	F	F	F	F	F	VF	VF	VF
TXR80017	F	F	F	F	VF	VF	VF	VF
TXR8002	F	F	F	F	VF	VF	VF	VF
TXR80028	F	F	F	F	F	VF	VF	VF
TXR8003	F	F	F	F	F	F	VF	VF
TXR80036	F	F	F	F	F	F	VF	VF
TXR8004	F	F	F	F	F	F	VF	VF
TXR80049	F	F	F	F	F	F	F	F

XR TeeJet® (XR)

	PSI						
	15	20	25	30	40	50	60
XR8001	F	F	F	F	F	F	F
XR80015	M	F	F	F	F	F	F
XR8002	M	M	F	F	F	F	F
XR80025	M	M	F	F	F	F	F
XR8003	M	M	M	F	F	F	F
XR80035	M	M	M	M	M	F	F
XR8004	C	M	M	M	M	F	F
XR8005	C	C	M	M	M	M	F
XR8006	C	C	C	M	M	M	M
XR8008	VC	VC	C	C	M	M	M
XR8010	XC	VC	VC	C	C	C	C
XR8015	XC	XC	VC	VC	VC	C	C
XR11001	F	F	F	F	F	F	VF
XR110015	F	F	F	F	F	F	F
XR11002	M	F	F	F	F	F	F
XR110025	M	M	F	F	F	F	F
XR11003	M	M	M	F	F	F	F
XR11004	M	M	M	M	M	F	F
XR11005	M	M	M	M	M	F	F
XR11006	C	M	M	M	M	M	F
XR11008	C	C	C	C	M	M	M
XR11010	VC	C	C	C	M	M	M
XR11015	VC	VC	VC	VC	C	C	C

TK FloodJet® (TK-VP)

	PSI				
	10	20	30	40	50
TK-VP1	C	M	F	F	F
TK-VP1.5	C	M	F	F	F
TK-VP2	C	M	F	F	F
TK-VP2.5	C	M	F	F	F
TK-VP3	C	M	F	F	F
TK-VP4	C	M	M	F	F
TK-VP5	C	M	M	F	F
TK-VP7.5	VC	C	C	C	M
TK-VP10	XC	VC	C	C	M

XP BoomJet® (XP)

	PSI				
	20	30	40	50	60
1/4XP10R 1/4XP10L	UC	UC	UC	UC	UC
1/4XP20R 1/4XP20L	UC	UC	UC	UC	UC
1/4XP25R 1/4XP25L	UC	UC	UC	UC	UC
1/4XP40R 1/4XP40L	UC	UC	UC	UC	UC
1/4XP80R 1/4XP80L	UC	UC	UC	UC	UC

XRC TeeJet (XRC)

	PSI						
	15	20	25	30	40	50	60
XRC80015	M	F	F	F	F	F	F
XRC8002	M	M	F	F	F	F	F
XRC8003	M	M	M	F	F	F	F
XRC8004	C	M	M	M	M	F	F
XRC8005	C	C	M	M	M	M	F
XRC8006	C	C	C	M	M	M	M
XRC8008	VC	VC	C	C	M	M	M
XRC11002	M	F	F	F	F	F	F
XRC110025	M	M	F	F	F	F	F
XRC11003	M	M	M	F	F	F	F
XRC11004	M	M	M	M	M	F	F
XRC11005	M	M	M	M	M	F	F
XRC11006	C	M	M	M	M	M	F
XRC11008	C	C	C	C	M	M	M
XRC11010	VC	C	C	C	M	M	M
XRC11015	VC	VC	VC	VC	C	C	C
XRC11020	XC	XC	XC	VC	VC	VC	VC

Plumbing Diagrams

The following diagrams have been developed to serve as a guideline for plumbing agricultural sprayers. Similar manual valves may be substituted for electric valves. However, the sequence in which these valves occur should remain the same. Note that one of the most common causes of premature valve failure is improper installation.

Positive Displacement Pump

Piston, roller and diaphragm pumps are all types of positive displacement pumps. This means that pump output is proportional to speed and virtually independent of pressure. A key component in a positive displacement system is the pressure relief valve. Proper placement and sizing of the pressure relief valve is essential for safe and accurate operation of a positive displacement pump.

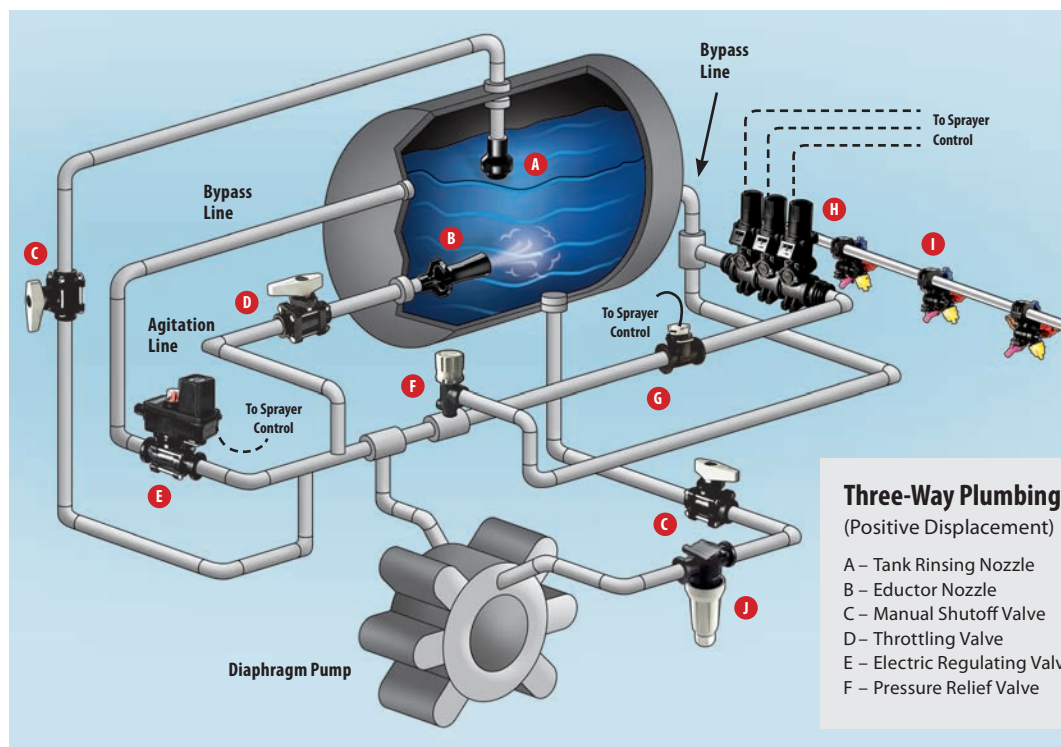
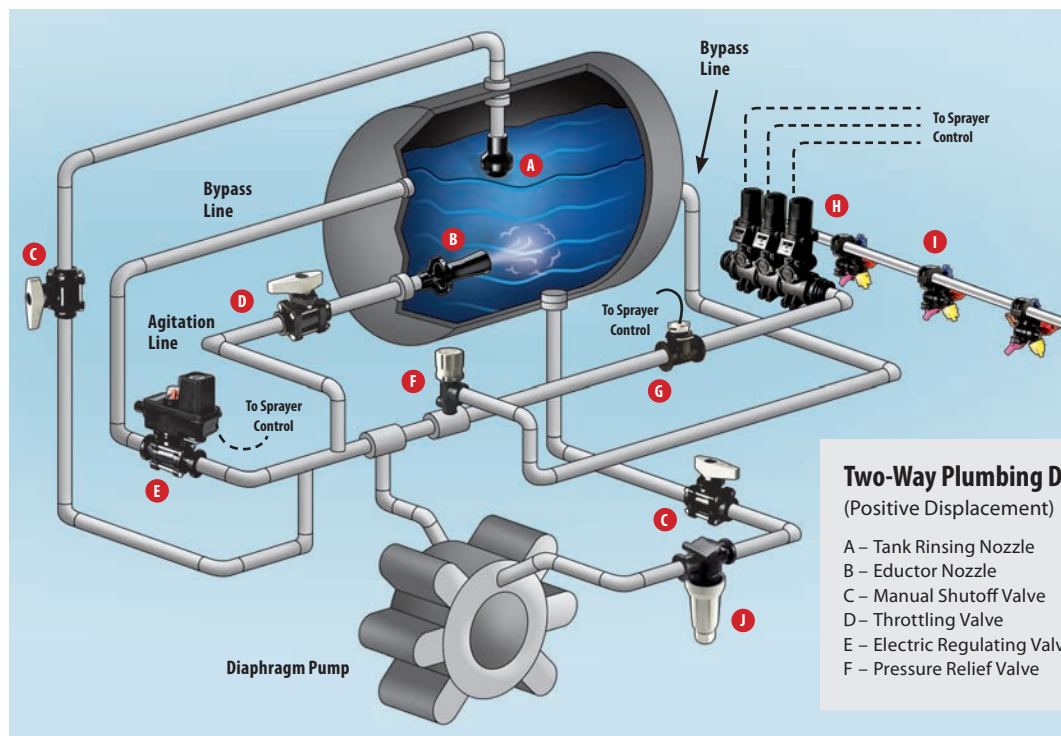

Non-Positive Displacement Pump

The centrifugal pump is the most common non-positive displacement pump. The output from this type of pump is influenced by pressure. This pump is ideal for delivering large volumes of liquid at low

pressures. A key component of the centrifugal pump is the throttling valve. A manual throttling valve on the main output line is essential for the accurate operation of the centrifugal pump.

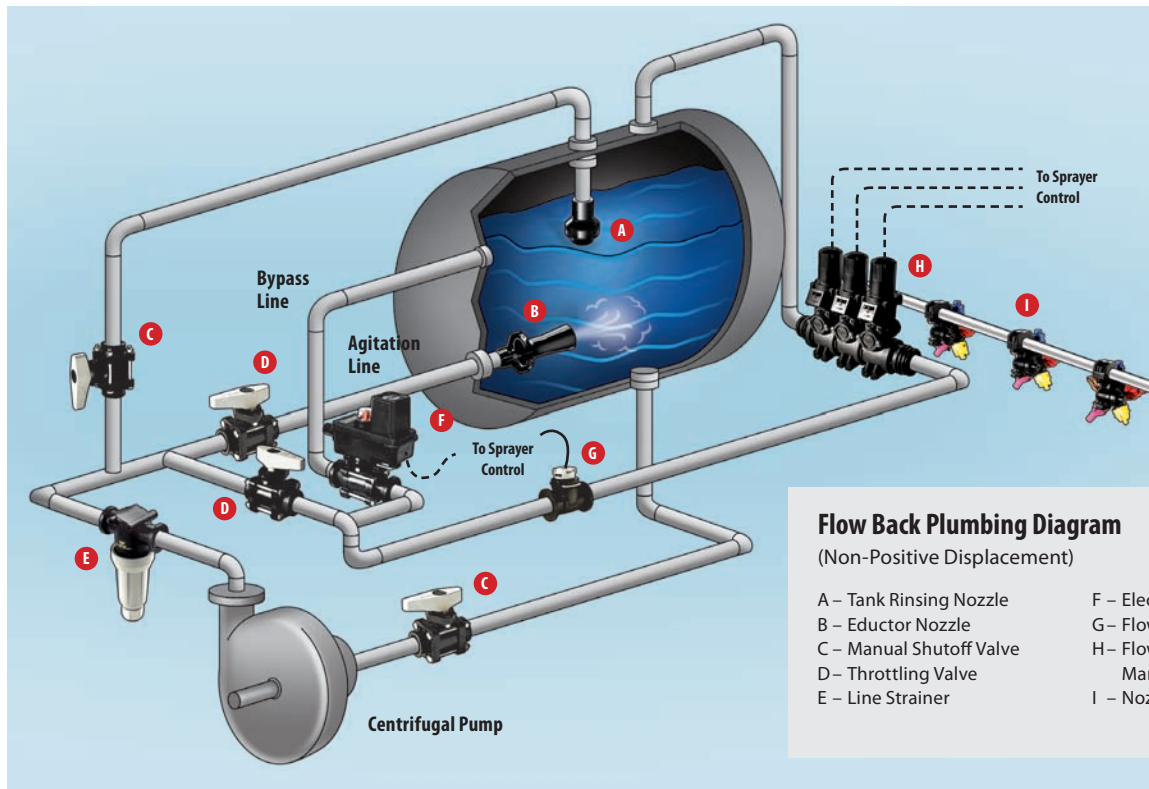
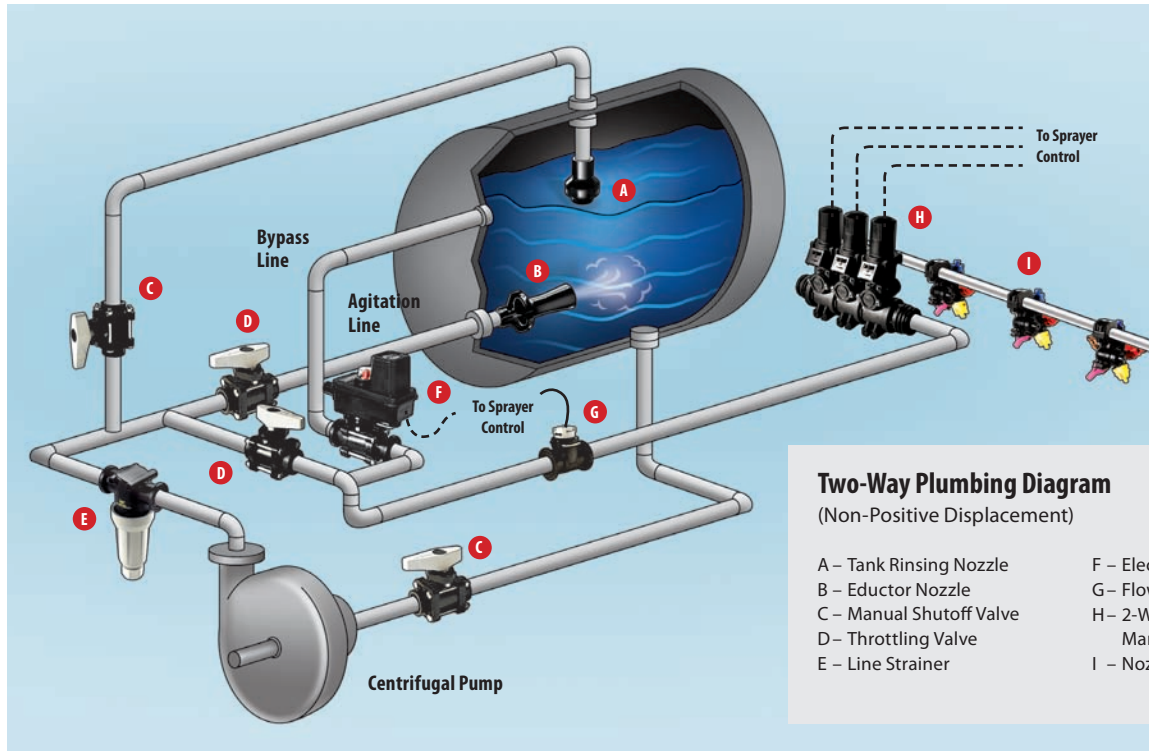

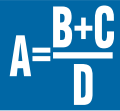

A small percentage of the items shown in this catalog may not be produced under an ISO registered system. For further information contact your sales representative.

(1) MODIFICATION OF TERMS

Seller's acceptance of any order is expressly subject to Buyer's assent to each and all of the terms and conditions set forth below and Buyer's assent to these terms and conditions shall be conclusively presumed from Buyer's receipt of this document without prompt written objection thereto or from Buyer's acceptance of all or any part of goods ordered. No addition to or modification of said terms and conditions shall be binding upon Seller unless specifically agreed to by Seller in writing. If Buyer's purchase order or other correspondence contains terms or conditions contrary to or in addition to the terms and conditions set forth below, acceptance of any order by Seller shall not be construed as assent to such contrary or additional terms and conditions or constitute a waiver by Seller of any of the terms and conditions.

(2) PRICE

Unless otherwise specified: (a) all prices, quotations, shipments and deliveries by Seller are (i) EXW (Incoterms® 2010) if shipped to the Buyer within the United States, and (2) in all other circumstances DAP Buyer's location (Incoterms® 2010); (b) all base prices together with related extras and deductions, are subject to Seller's price in effect at the time of shipment; and (c) notwithstanding the use of the shipping term DAP and without any effect on the point at which the risk of loss shifts from Seller to Buyer, all transportation, import costs and other related charges are for the account of Buyer, including all increases or decreases in such charges prior to shipment. Payment of said price shall be due at the remittance address shown on the Seller's invoice upon receipt of Seller's invoice unless otherwise specified. Interest will be charged at a rate of 1 to 1½% per month on all balances outstanding more than 30 days after the date of the invoice. Price includes Seller's standard packaging. Special packaging requirements shall be quoted at an additional price.

(3) UNIFORM COMMERCIAL CODE

THIS IS A CONTRACT FOR THE SALE OF GOODS. SELLER AND BUYER EXPRESSLY AGREE THAT ANY SERVICES PROVIDED PURSUANT TO THIS CONTRACT ARE MERELY INCIDENTAL TO THE SALE OF GOODS, AND AS SUCH, SHALL BE DEEMED GOODS UNDER ARTICLE 2 OF THE UNIFORM COMMERCIAL CODE. SELLER AND BUYER FURTHER AGREE THAT ANY DISPUTES ARISING FROM THIS CONTRACT SHALL BE GOVERNED BY ARTICLE 2 OF THE UNIFORM COMMERCIAL CODE.

(4) MINIMUM BILLING

Contact your regional office representative for any minimum order requirements.

(5) WARRANTIES

Seller warrants that its products will substantially conform to and perform in accordance with the products' specifications. Seller warrants that the products do not infringe upon any copyright, patent, or trademark. THE FOREGOING WARRANTIES ARE IN LIEU OF ALL OTHER WARRANTIES, EXPRESSED OR IMPLIED, INCLUDING, BUT NOT LIMITED TO, THOSE CONCERNING MERCHANTABILITY AND FITNESS FOR A PARTICULAR PURPOSE.

(6) LIMITATION OF REMEDIES

Buyer's remedies under this warranty shall be limited to the replacement, repair, or refund of the purchase price for any defective product at the Seller's option. Products claimed to be defective and for which repair or replacement is desired shall be, if requested by the Seller, returned transportation prepaid to Seller's

plant for inspection. Results of ordinary wear and tear, improper operation, or maintenance or use of corrosive or abrasive materials shall not be considered a defect in material or workmanship. Any component part manufactured by another is not covered by Seller's warranty, but only by such warranty as its manufacturer gives. Because of the difficulty of asserting and measuring damages hereunder, it is agreed that, except for claims for bodily injury, Seller's liability to the Buyer or any third party, for any losses or damages, whether direct or otherwise, arising out of the purchase of product from Seller by Buyer shall not exceed the total amount billed and billable to the Buyer for the product hereunder. IN NO EVENT WILL SELLER BE LIABLE FOR ANY LOSS OF PROFITS OR OTHER SPECIAL OR CONSEQUENTIAL DAMAGES, EVEN IF SELLER HAS BEEN ADVISED OF THE POSSIBILITY OF SUCH DAMAGES.

(7) QUALITY ASSURANCE

Seller shall have no obligation to ensure that any goods purchased from Seller meet any special Buyer quality assurance specifications and/or other special Buyer requirements unless such specifications and/or other requirements are specifically set forth in Buyer's purchase order and expressly accepted by Seller. In the event that any such goods supplied by Seller in connection therewith, are applied to an end use without the appropriate specification and/or other requirement therefore having been set forth in Buyer's purchase order and expressly accepted by Seller, Buyer shall indemnify and hold Seller harmless against any and all damages or claims for damages made by any person for any injury, fatal or nonfatal, to any person or for any damage to the property of any person incident to or arising out of such application.

(8) CLAIMS

Claims respecting the condition of goods, compliance with specifications or any other matter affecting goods shipped to Buyer must be made promptly and, unless otherwise agreed to in writing by Seller, in no event later than one (1) year after receipt of the goods by Buyer. In no event shall any goods be returned, reworked or scrapped by Buyer without the express written authorization of Seller.

(9) DEFAULT IN PAYMENT

If Buyer fails to make payments on any contract between Buyer and Seller in accordance with Seller's terms, Seller, in addition to any other remedies available to it, may at its option, (i) defer further shipments until such payments are made and satisfactory credit arrangements are reestablished or (ii) cancel the unshipped balance of any order.

(10) TECHNICAL ASSISTANCE

Unless otherwise expressly stated by Seller, (a) any technical advice provided by Seller with respect to the use of goods furnished to Buyer shall be without charge; (b) Buyer shall have sole responsibility for selection and specification of the goods appropriate for the end use of such goods.

(11) SAFETY PRECAUTIONS

Buyer shall require its employees to use all safety devices, and proper safe operation procedures as set forth in manuals and instruction sheets furnished by Seller. Buyer shall not remove or modify any such device or warning sign. It is the Buyer's responsibility to provide all means that may be necessary to effectively protect all employees from serious bodily injury which otherwise may result from the method of particular use, operation, set up or service of the goods. The operator's or machine manual, ANSI safety standards, OSHA regulations and other sources should be consulted. If Buyer fails to comply with provisions of this paragraph or the applicable standards and regulations aforementioned, and a person is injured as a result thereof, Buyer

agrees to indemnify and save Seller harmless from any liability or obligation incurred by Seller.

(12) CANCELLATION

Orders for goods specifically manufactured for Buyer cannot be canceled or modified by Buyer, and releases cannot be held up by Buyer, after such goods are in process except with the express written consent of Seller and subject to conditions then to be agreed upon which shall include, without limitation, protection of Seller against all loss.

(13) PATENTS

The Seller shall not be liable for any costs or damages incurred by the Buyer as a result of any suit or proceeding brought against Buyer so far as based on claims (a) that use of any product, or any part thereof furnished hereunder, in combination with products not supplied by the Seller or (b) that a manufacturing or other process utilizing any product, or any part thereof furnished hereunder, constitute knowing and willful infringement of patents or trademarks arising from compliance with Buyer's designs or specifications or instructions.

(14) COMPLETE AGREEMENT

THIS CONTRACT SETS FORTH THE ENTIRE AGREEMENT AND UNDERSTANDING OF THE PARTIES RELATING TO THE SUBJECT MATTER HEREOF, AND SUPERSEDES ALL PRIOR AGREEMENTS, DISCUSSIONS AND UNDERSTANDINGS BETWEEN THEM WHETHER ORAL OR WRITTEN, RELATING TO THE SUBJECT MATTER HEREOF.

(15) GOVERNING LAW

All orders are accepted by Seller at its mailing address in Wheaton, Illinois, and shall be governed by and interpreted in accordance with the laws of the State of Illinois. The United Nations Convention on Contracts for the International Sale of Goods of April 11, 1980 shall be excluded.

(16) FORCE MAJEURE

Neither party shall be in default of its obligations to the other party for any period of Force Majeure. "Force Majeure" shall mean any delay or failure of a party to perform its obligations to the other party due to causes beyond its control and without its fault or negligence. This shall include, without limitation, Acts of God, strike, civil commotion, acts of government, and any other comparable, non-foreseeable, and a serious event.

(17) CONFIDENTIAL INFORMATION

Buyer shall maintain Confidential Information in confidence using the same care as used for its own Confidential Information. Buyer shall not disclose or divulge any Confidential Information received by it from Seller in connection with any products or services supplied by Seller to Buyer or to a third party without prior written consent of Seller, and Buyer may not use any Confidential Information for any purpose other than for the manufacture, sale and maintenance of Buyer's products. For the purposes hereof, "Confidential Information" includes any and all information and data, including, but not limited to, any business, commercial, intellectual property, technical information and data disclosed by Seller to Buyer in connection with the sale of Seller's products to Buyer, or relating to Seller's business relationship or the definition, development, marketing, selling, manufacture or distribution of Seller's products, whether disclosed orally, in writing or electronically, and irrespective of the medium in which such information or data is embedded, whether in tangible form or contained in an intangible storage medium. Confidential Information shall include any copies or abstracts made thereof, as well as any product, apparatus, modules, samples, prototypes or parts thereof.



The most trusted name in spray products and application control systems.

At TeeJet Technologies our single focus is on application technology. Our company and our products have been part of agricultural applications since the first crop protection products came onto the market in the 1940's. Innovative, industry-leading solutions in the fields of spraying, fertilizing and seeding are what you've come to expect from TeeJet, and we are constantly developing the products and technologies to help you take your business to the next level.

GPS GUIDANCE SYSTEMS



The Matrix® Pro 570GS and 840GS guidance systems offer robust, easy-to-use guidance for a wide range of applications and include TeeJet exclusive features such as RealView® guidance over video and droplet size monitoring. The Matrix Pro GS also supports BoomPilot® automatic boom section control for liquid and dry applications, FieldPilot® and UniPilot® assisted steering, coverage mapping, and video monitoring to maximize your productivity.

DROPLET SIZE MONITORING

TeeJet exclusive droplet size monitoring provides real-time, in-cab display of your spray droplet size. By monitoring your droplet size you can better manage your spray application to reduce spray drift and optimize crop coverage. Droplet size monitoring is an available feature on Matrix Pro GS, Aeros 9040, and Radion 8140 or as a standalone monitor—the Sentry 6120.



TIP FLOW MONITORING

Sentry 6140 tip flow monitor uses individual tip flow meters to detect flow variations on your sprayer or liquid fertilizer applicator caused by clogged, damaged or partially obstructed tips. The ability to immediately detect any flow variations greatly reduces the likelihood of misapplication and reduces stress on the operator.



PWM SPRAYER CONTROL

DynaJet Flex 7120 PWM sprayer control uses pulse width modulation technology with solenoid operated tip shutoffs to control tip flow rate and droplet size independent of one another. This allows for improved sprayer productivity by maintaining a constant application rate over a wider range of speeds. It can also be used to minimize drift and maximize coverage by maintaining the optimum droplet size.



Celcon is a trademark of Celanese Corp.
Fairprene, Teflon and Viton are trademarks of E.I. DuPont de Nemours and Co.

AirJet, AirMatic, BoomJet, BoomPilot, ChemSaver, ConeJet, DG TeeJet, DirectoValve, e-ChemSaver, FieldJet, FieldPilot, FloodJet, FullJet, GunJet, Matrix, MeterJet, QJ, Quick FloodJet, Quick TeeJet, RealView, Spraying Systems Co., SSSCo, Logo, TeeJet, TeeValve, TriggerJet, Turbo FloodJet, Turbo TeeJet, TwinJet, UniPilot, VeeJet, VisiFlo, WhirlJet and XR TeeJet are registered trademarks of TeeJet Technologies, and are registered in many countries around the world.



Wheaton Facility

P.O. Box 7900
Wheaton, Illinois
60187-7901 USA

Springfield Facility

1801 Business Park Drive
Springfield, Illinois
62703 USA

Aabybro Facility

Mølhavevej 2
DK 9440 Aabybro
Denmark

www.teejet.com



Spraying Systems Co. World Headquarters
Wheaton, Illinois USA

All rights reserved. Full Protection of law claimed under Universal Copyright
and Berne Conventions and other applicable national and international laws.

Printed in U.S.A.
© Copyright 2014 TeeJet Technologies

LI51A