

# **OPERATORS MANUAL FOR THE LH 1200S SPRAYER MONITOR**

LH no. 021-202-UK Version 2.00

## **LH Technologies Denmark ApS**

Mølhavevej 2  
9440 Aabybro  
Denmark

Tel. +45 9696 2500

Fax. +45 9696 2501

Internet: <http://www.lh-agro.com/>



# Contents

INTRODUCTION .....	4
GENERAL USE .....	5
FERTILISER DISTRIBUTOR .....	5
SEED DRILL .....	6
SYSTEM DESCRIPTION.....	7
918-123 LH 1200S FITTING KIT WITHOUT SWITCHES .....	7
916-123 LH 1200S FITTING KIT WITH SWITCHES.....	8
THE MONITOR .....	9
PLUG CONNECTIONS .....	9
PRIMARY FUNCTIONS.....	10
WORK TIME.....	10
FORWARD SPEED.....	10
AREA COUNTERS .....	11
APPLICATION RATE FOR SPRAY CHEMICALS.....	12
BOOM SECTION COMPENSATION .....	12
SPRAY CHEMICAL CONSUMPTION PER MINUTE.....	13
SPRAY CHEMICAL CONSUMPTION.....	13
SECONDARY FUNCTIONS, FERTILISER DISTRIBUTOR .....	14
RPM FOR DISC SPREADERS .....	14
FERTILISER DISTRIBUTOR WITH FEED ROLLER (PNEUMATIC).....	14
SECONDARY FUNCTIONS, SEED DRILL .....	15
SOW AXLE RPM.....	15
SEED RATE MONITORING.....	15
SECONDARY FUNCTIONS; SLURRY SPREADER.....	16
APPLICATION RATE MONITORING.....	16
SECONDARY FUNCTIONS, BALER.....	17
UNIT COUNTER .....	17
SECONDARY FUNCTIONS, DISTANCE MEASURING.....	17
ENCODING .....	18
FORWARD SPEED CALIBRATION (WHEEL CIRCUMFERENCE) .....	18
AUTOMATIC SPEED SENSOR CALIBRATION.....	18
MANUAL SPEED CALIBRATION .....	19
WORKING WIDTH AND BOOM SECTIONS .....	19
1. ENCODING THE WORKING WIDTH .....	19
2. ENCODING BOOM SECTIONS WIDTHS.....	20
QUANTITY CORRECTION .....	20
FLOWMETER CALIBRATION (FLOW FIGURE) .....	22
VOLUME MONITORING CALIBRATION FOR SEED AND FERTILISER.....	23
SYSTEM TEST .....	25
ERROR WARNING.....	25
TRAILER PLUG CONNECTIONS .....	26
SPRAYER.....	26
FERTILISER DISTRIBUTOR/SEED DRILL.....	26
TECHNICAL DATA.....	27

---

## INTRODUCTION

---

Congratulations with your new LH 1200S sprayer monitor with boom compensating features.

During development of this monitor we have made a point of producing a durable product that is primarily developed to monitor chemical application. The monitor, however, includes a number of other functions, which enable it to be used in connection with almost any other implement.

If the monitor is used in accordance with the guidelines in this manual, the LH 1200S will be a true and reliable assistant for you for many years.

*We have endeavoured to deliver a fault free product. To ensure optimal use of the equipment we ask that great attention be paid when reading the manual. We are more than happy to help should any queries arise, both when the product is used for the first time and at any later date. Regarding responsibility for use of the product we refer to our sales and delivery terms especially paragraph 7, which follows:*

7. Product usage.

7.1 Any use of the product is at the sole risk of the buyer. The buyer is therefore not entitled to any form for compensation caused by, for example, any of the following:

- Disturbance to/from any electronic services or products that do not conform to the standards for CE marking,
- Missing or poor signal coverage or a succession hereof from external transmitters/receivers, used by the buyer,
- Functional faults, which apply to or from a PC-program or PC-equipment, not delivered by the seller,
- Faults that may arise from the buyers negligence to react to warnings and fault messages from the product, or which can be traced to negligence and/or absent constant control of the work carried out in comparison to the planned job.

7.2 When implementing any new equipment the buyer must take great care and pay attention. Any doubts as to correct operation/use should result in contacting the sellers service department.

## GENERAL USE

The LH 1200S is especially designed for use on a crop sprayer. The following functions can be selected directly from the keypad:

1. *Work time*
2. *Forward speed*
3. *Area counters (trip- and total)*
4. *Chemical application rate*
5. *Chemical consumption per minute*
6. *Chemical consumption (litre counter)*

The monitor can also be used in connection with other implements by encoding some special values (codes).

The secondary functions are as follows:

- *Distance in metres*
- *Shaft speed (RPM)*
- *Fertiliser application rate*
- *Sow seed application rate*
- *Fertiliser consumption (Kg counter)*
- *Sow seed consumption ( Kg counter)*
- *Unit counter*

These functions can be placed into the following implement related sets:

### FERTILISER DISTRIBUTOR

A:	B:
Work time	Work time
Forward speed	Forward speed
Area trip counter	Area trip counter
Area total counter	Area total counter
Shaft speed (RPM)	Fertiliser application rate
	Fertiliser consumption

Fertiliser APPLICATION RATE and CONSUMPTION are only possible on fertiliser distributors fitted with feed rollers.

**SEED DRILL**

A:	B:
Work time	Work time
Forward speed	Forward speed
Area trip counter	Area trip counter
Area total counter	Area total counter
Shaft speed (RPM)	Seed application rate
	Seed consumption

The above examples show that three basic functions, TIME, FORWARD SPEED, and AREA are always available. The secondary functions can be selected as required.

The monitor can measure distance in metres as an extra function. This function requires a special encodement (code) and can, therefore, only be used by itself. All other information displayed is incorrect when this function is selected.

When the boom section function is activated, the display will change between the selected function and the boom section status. The display changes every other second.

When forward speed is selected and the area override sensor is activated an "r" is displayed on the left-hand side of the display.

The LH 1200S is equipped with a system test program, which enables the user to test all connected sensors. For more information, see the "SYSTEM TEST" chapter on page 25.

## SYSTEM DESCRIPTION

The LH 1200S can be supplied with two different fitting kits. The difference between the kits allows for greater flexibility.

The standard fitting kit (LH No. 918-123) is suitable if the monitor is only to be used in conjunction with one implement and if you do not need to change between several sensors.

The fitting kit with changeover switches (LH No. 916-123) is suitable if the monitor is to be used in conjunction with several different implements. It is possible to select between several different sensors using the changeover switches on the junction box.

The two fitting kits itemised with part references below:

### 918-123 LH 1200S FITTING KIT WITHOUT SWITCHES

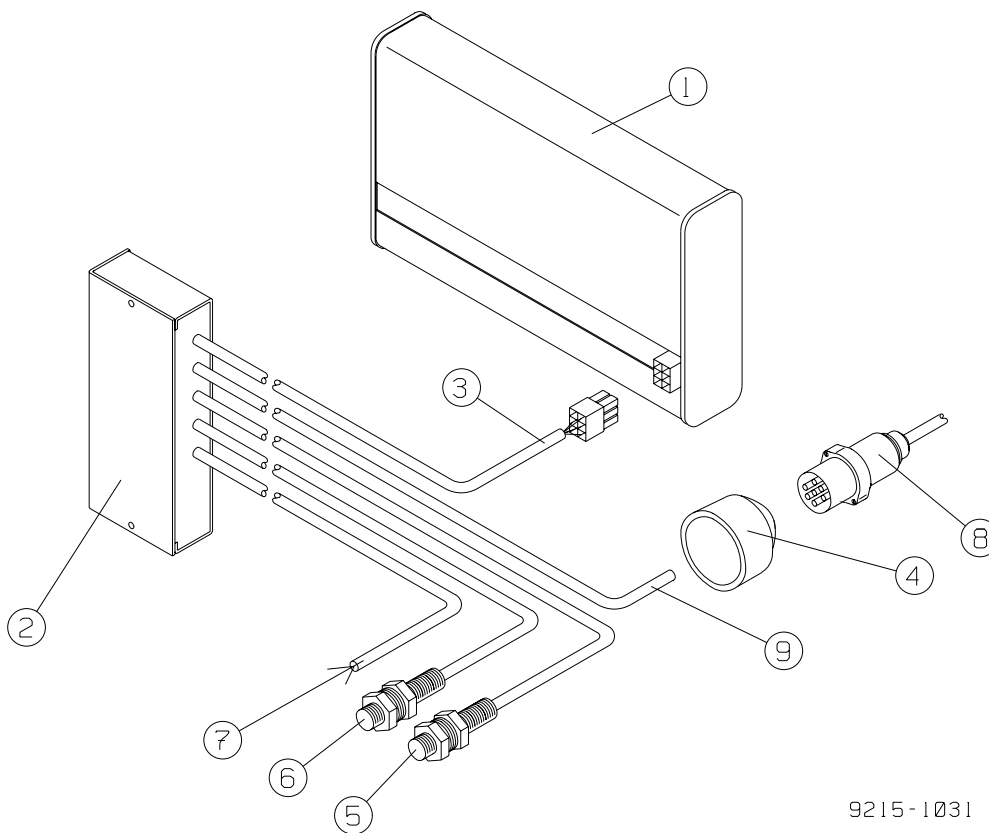

9215-1031

Pos.	LH No.	Description
1	915-122	LH 1200S Monitor
2	905-122	Junction box, standard
3	198-140	LH 1200S main cable
4	178-600	LH trailer plug socket, 7-pin
5	901-982	Override sensor (start/stop area counter)
6	901-982	Wheel sensor
7	900-754	Power supply cable
8	178-601	Trailer plug, 7-pole
9	956-005	Cable for trailer plug (5 x 0,5)

**916-123 LH 1200S FITTING KIT WITH SWITCHES**

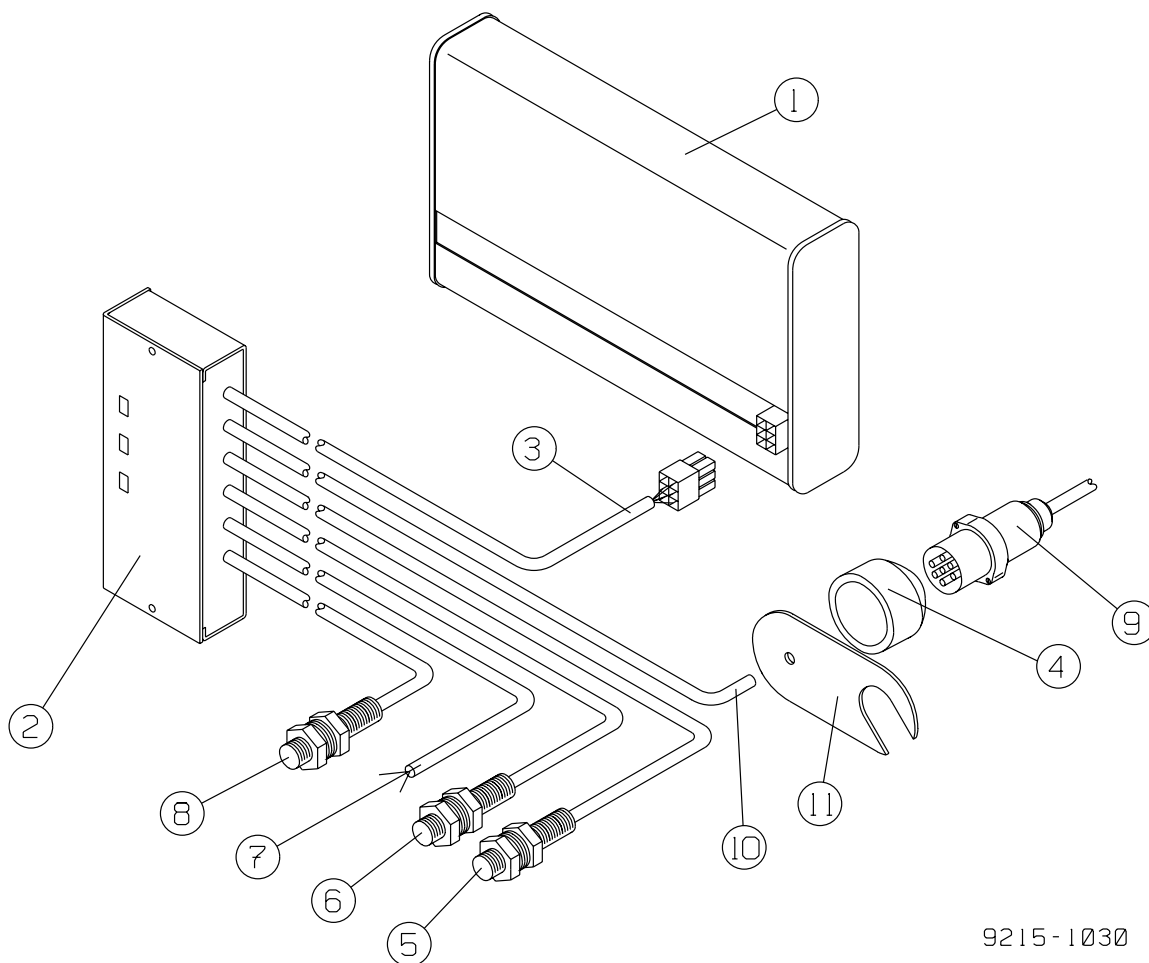

9215-1030

Pos.	LH No.	Description
1	915-122	LH 1200S Monitor
2	908-122	Junction box with changeover switches
3	198-140	LH 1200S Main cable
4	178-600	LH trailer plug socket, 7-pin
5	901-982	Override sensor (start/stop area counter)
6	901-982	Wheel sensor
7	900-754	Power supply cable
8	900-983	PTO Sensor (optional extra)
9	178-601	Trailer plug, 7-pin
10	956-005	Cable for trailer plug (5 x 0,5)
11	842-521	Fitting bracket for trailer bracket

Beyond the above-described parts, screws, brackets, magnets, etc. are also included in the kits.



## THE MONITOR

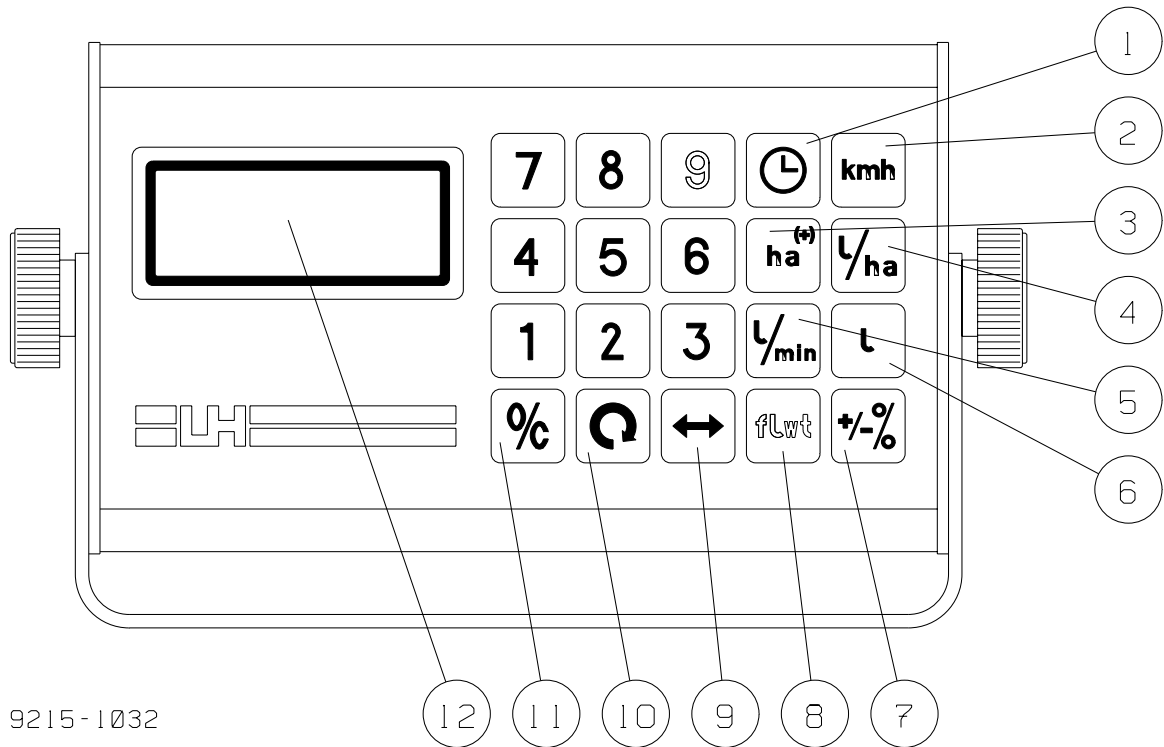

9215-1032

Pos.	Function	Pos.	Function
1	Work time	7	Flowmeter calibration
2	Forward speed	8	Flow figure encodement
3	Area trip/total counter	9	Working width encodement
4	Application rate	10	Wheel circumference encodement
5	Litre consumption per minute	11	Delete and numerical 0 key
6	Litre counter	12	4-digit illuminated LCD-display

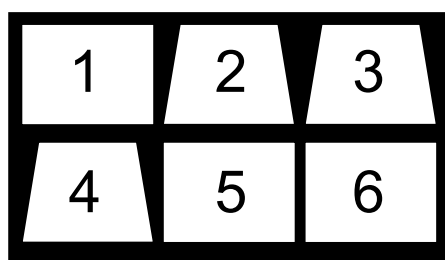

## PLUG CONNECTIONS

Pos.	Description
1	0 Volt
2	+12 Volt
3	Area override
4	Wheel sensor
5	Flowmeter/PTO
6	



## PRIMARY FUNCTIONS

### WORK TIME



Key	Function
	<p><b>WORK TIME IN HOURS AND MINUTES</b></p> <p>Pressing this key displays the effective work time (max. 99 hours 59 minutes)</p> <p>The time counter is started and stopped by pressing the key.</p> <p>Flashing colon &gt;:&lt; means that the time counter is running.</p> <p>Constant colon &gt;:&lt; means that the time counter is stopped.</p>
	<p>Pressing this key for min. 3 seconds resets the counter.</p>



### FORWARD SPEED

Key	Function
	<p><b>KILOMETRES PER HOUR</b></p> <p>Pressing this key displays the present forward speed in kilometres per hour with 1 decimal.</p> <p>Forward speed is <u>always</u> displayed when the monitor is switched on.</p> <p>An “r” on the left-hand side of the display under this function, indicates that the area override sensor has been activated.</p> <p><b>NOTE!</b> This indicator is only displayed when forward speed has been selected.</p> <p>Forward speed is zeroed after approx. 8 second after stopping.</p> <p>Remember to select the “correct” wheel sensor and encode the correct value if a fitting kit with switches has been fitted.</p>

## AREA COUNTERS

The area trip and the area total counters are placed under the same key. Area trip is displayed the first time the key is pressed, as this is the counter most frequently used. Pressing the key for min. 3 seconds displays the area total counter.

Key	Function
	<p><b>AREA TRIP COUNTER</b></p> <p>Pressing this key displays the effective worked area. Area is displayed with 2 decimals from 0 – 99.99 ha. and with 1 decimal from 100 – 999.9 ha.</p> <p>The area counter is started and stopped with the fitted area override sensor. This ensures that area is only counted when the implement is working.</p> <p>Take care to select the “correct” override sensor if a fitting kit with changeover switches is used.</p> <p>The area trip counter counts synchronically with the area total counter.</p> <p><b>NOTE!</b> This key has a different function if 8888 or 9999 are encoded as the working width.</p>
	<p>Pressing this key for min. 3 seconds resets the counter.</p>

	<p><b>AREA TOTAL COUNTER</b></p> <p>Pressing this key for min 3 seconds displays the area total counter. The total effective area is displayed with 1 decimal from 0 to 999.9 ha. and without decimals from 1000 to 9999 ha.</p> <p>This function can be used to sum up the worked area for a season or a year.</p> <p>The area total counter counts synchronically with the area trip counter.</p> <p><b>NB!</b> This key has a different function if 8888 or 9999 are encoded as the working width.</p> <p>Pressing this key again displays the area trip counter.</p>
	<p>Pressing this key for min. 3 seconds resets the counter.</p>

## APPLICATION RATE FOR SPRAY CHEMICALS

Key	Function
	<p><b>APPLICATION RATE</b></p> <p>Pressing this key displays the present application rate in litres per ha.</p> <p>The calculated application rate is based on the flow through the flowmeter and area metering. Thus, the application rate can only be displayed if the sprayer is in operation and the machine is moving forward.</p> <p>Correct performance presupposes correct calibration of the flowmeter (see page 22). Flowmeter calibration should be checked at regular intervals.</p> <p>Remember to select the flowmeter and encode the flow figure for a flowmeter if the machine is fitted with a fitting kit with changeover switches.</p> <p><b>NOTE!</b> This key has a different function if 9999 has been encoded as the flow figure.</p>

## BOOM SECTION COMPENSATION

The LH 1200S has a manual boom compensation feature allowing you to switch the individual boom sections on and off when they are on/off on the sprayer using the keypad. The display changes once every second.

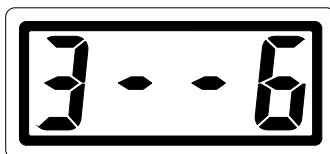

The above example shows that sections 3,4,5 and 6 are open. The LH 1200S only allows sections to be closed in succession from one of the sides (or from both sides). A section in the middle of the boom cannot be shut off by itself.

The sections are “switched” on and off using the numerical keys. The keys have a double function (toggle), i.e. if section 1 is open it can be closed by pressing the numerical key 1 if section 1 is closed it can be opened likewise by pressing the numerical key 1.

### *Example:*

Let us assume that the above display is for a 6-section sprayer of which sections 1 and 2 are closed and sections 3, 4, 5, and 6 are open. The following is possible:

- Section 2 can be opened by pressing the numerical key 2.
- Sections 3 and 6 can be closed by pressing the numerical keys 3 and 6 respectively.

If the area override sensor is activated (sprayer is closed) the monitor will automatically return to calculating with the full boom width.

The individual section sizes are encoded separately see the chapter on section encodement, page 20.

The boom section function will be displayed regardless of which function (white keys) has been selected.

## SPRAY CHEMICAL CONSUMPTION PER MINUTE

Key	Function
	<p><b>LITRE PER MINUTE</b></p> <p>Pressing this key displays the liquid flow <u>through the flowmeter</u>. The amounts shown must not be confused as pump capacity, as there is a return flow to the tank before the flowmeter.</p> <p>Correct performance presupposes flowmeter calibration (see page 22). Flowmeter calibration should be checked at regular intervals during the season.</p> <p>Remember to select the flowmeter and encode the flow figure for the flowmeter if a fitting kit with changeover switches has been fitted.</p>

## SPRAY CHEMICAL CONSUMPTION

Key	Function
	<p><b>LITRE COUNTER</b></p> <p>Pressing this key displays the total consumption of spray chemicals in litres.</p> <p>Correct performance presupposes flowmeter calibration (see page 22). Flowmeter calibration should be checked at regular intervals during the season.</p> <p>Remember to select the flowmeter and encode the flow figure for the flowmeter if a fitting kit with changeover switches has been fitted.</p> <p><b>NOTE!</b> This key has a different function if 9999 is encoded as a flow figure.</p>

## SECONDARY FUNCTIONS, FERTILISER DISTRIBUTOR

There are two different function sets available for fertiliser distributors, depending on which type of spreader is being used.

As mentioned before, the functions TIME, FORWARD SPEED, and AREA functions are always available and operate in the same way as described in the PRIMARY FUNCTIONS section of this manual.

### RPM FOR DISC SPREADERS

Encoding a flow figure of 9999 alters the program in the LH 1200S allowing it to display RPM. RPM is displayed by pressing the L/Ha. key.

ENCODE:





 Press the shown keys in this order.





Key	Function
	<b>RPM</b> <b>NOTE!</b> The L/MIN key and the L key cannot be used when this encodement is used.



### FERTILISER DISTRIBUTOR WITH FEED ROLLER (PNEUMATIC)

It is possible to meter the “flow” of fertiliser on this kind of fertiliser distributor using a special sensor, which gives a suitable number of pulses per revolution.

By encoding the calibration figure as a flow figure, the following functions are available:

ENCODE:





 XXXX is the determined calibration figure in grams with 2 decimals. Thus, a calibration figure of 15.00 is encoded as 1500. The displayed application rate will be in Kg.

Key	Function
	<b>FERTILISER APPLICATION RATE</b>
	<b>FERTILISER CONSUMPTION PER MINUTE</b>
	<b>TOTAL FERTILISER CONSUMPTION</b>

**NOTE!** It is a condition for the above functions that the sensor is correctly calibrated. A new calibration must take place if the spreader settings are altered.

## SECONDARY FUNCTIONS, SEED DRILL

Exactly the same functions can be achieved for seed drills as described above for fertiliser distributors. The functions require the same sensors and the same keys are used.

### SOW AXLE RPM

Encoding a flow figure of 9999 alters the program in the LH 1200S allowing it to display RPM. RPM is displayed by pressing the L/Ha. key.

ENCODE:

flwt 9 9 9 9 Press the shown keys in this order.

Key	Function
<span>L/ha</span>	<b>RPM</b> <b>NOTE!</b> The L/MIN key and the L key cannot be used when this encodement is used.

### SEED RATE MONITORING

It is possible to meter the “flow” of seed using a special sensor, which gives a suitable number of pulses per revolution. The calibration figure is determined during the normal calibration procedure for the seed drill.

By encoding the calibration figure as a flow figure, the following functions are available:

ENCODE:

flwt X X X X XXXX is the determined calibration figure in grams with 2 decimals. Thus, a calibration figure of 15.00 is encoded as 1500. The displayed seed rate will be in Kg.

Key	Function
<span>L/ha</span>	<b>SEED RATE</b>
<span>L/min</span>	<b>SEED CONSUMPTION PER MINUTE</b>
<span>L</span>	<b>TOTAL SEED CONSUMPTION</b>

**NOTE!** It is a condition for the above functions that the sensor is correctly calibrated. A new calibration must take place if the spreader settings are altered.

## SECONDARY FUNCTIONS; SLURRY SPREADER

### APPLICATION RATE MONITORING

Flow metering is possible on slurry spreaders either by using a flowmeter (electromagnetic) or by a RPM sensor fitted to a positive displacement pump (exact volume per revolution).

By encoding an amount in kilos (with 2 decimals) per impulse as a flow figure the following functions are available:

ENCODE:



XXXX is the known calibration figure in kg with 2 decimals. 5.00 kg is encoded as 500 The application rate will be shown as m<sup>3</sup>/ha.

Key	Function
$\text{L}/\text{ha}$	SLURRY APPLICATION RATE
$\text{L}/\text{min}$	SLURRY CONSUMPTION PER MINUTE
L	TOTAL SLURRY CONSUMPTION

**NOTE!** It is a condition for correct operation of all three functions that the flow sensor is calibrated.



---

## SECONDARY FUNCTIONS, BALER

---

### UNIT COUNTER

It is possible to count the number of bales baled. Encoding a flow figure of 9999 and pressing the L key enables the unit counter.

ENCODE:





 Press the shown keys in this order.

Key	Function
	<b>UNITS</b> <b>NOTE!</b> The L/MIN key and the L key cannot be used when this encodement is used.

---

## SECONDARY FUNCTIONS, DISTANCE MEASURING

---

This function can only be used alone. When this function is activated, all other functions are unusable.

ENCODE:





 Press the shown keys in this order.

Key	Function
	<b>DISTANCE IN METRES</b> <b>NOTE!</b> The maximum distance is 9999 metres.

---

## ENCODING

---

### FORWARD SPEED CALIBRATION (WHEEL CIRCUMFERENCE)

Key	Function
	<b>WHEEL CIRCUMFERENCE</b>

The distance in centimetres that is driven per pulse from the speed sensor is encoded here.

Depending on which vehicle is used the speed signal can come from a sensor built into the gearbox, from a sensor fitted by the prop. Shaft (4-wheel drive) or from a sensor fitted by one of the wheels.

The LH 1200S features an automatic speed calibration procedure, which can be used for integrated or prop. Shaft sensors. The automatic calibration procedure can also be used for normal wheel sensors if the wheel circumference does not exceed 100 cm when divided by the number of magnets.

**NOTE!** It is recommended to fit as many magnets on the wheel as necessary to ensure that the encoded wheel circumference does not exceed 100 cm.

### AUTOMATIC SPEED SENSOR CALIBRATION

1. Measure a distance of 100 m and drive to the start mark.
2. Press the “**WHEEL CIRCUMFERENCE**” key once. Release the key and then press and hold the key down until “AUTO” is displayed. Press the “**WHEEL CIRCUMFERENCE**” key again and the monitor is ready for automatic speed sensor calibration.
3. Drive the 100-metre stretch and stop **exactly** at the stop mark. The monitor will count the number of pulses received from the sensor.
4. If the monitor has received enough pulses from the sensor (over 100 pulses per 100 metres), it will calculate the effective wheel circumference when the “**WHEEL CIRCUMFERENCE**” key is pressed again. The calculated value is shown on the display.

If the monitor has not received over 100 pulses over the 100-metre stretch, it will display 0 after pressing the key. One of the following two methods can be used hereafter:

- a: Manual measuring of the value to be encoded as described below
- b: Fitting more magnets to increase the number of pulses per 100 metres.

**REMEMBER!** It is important that the distance between the magnets is the same. Otherwise, the displayed speed will fluctuate.

## MANUAL SPEED CALIBRATION

1. Mark the field and the tyre.
2. Drive forward until the wheel has turned 10 times.
3. Mark the field again.
4. Measure the distance between the two marks and divide by 10. The result is the effective wheel circumference.
5. Divide the effective wheel circumference by the number of magnets fitted. Encode the result in centimetres with 1 decimal, 2.535 m is encoded as 253.5 cm. the maximum value that can be encoded is 300.0 cm.

**NOTE!** Remember to count wheel revolutions on the wheel that the magnets are fitted.

## WORKING WIDTH AND BOOM SECTIONS

Key	Function
	<b>WORKING WIDTH</b>

This encodement value is divided into main encodement values – **the total working width** – and some sub-encodements – **quantity correction yes/no, when the individual boom sections (the width of) are turned off.**

### **Procedure:**

As all of these encodements are placed under the same key, the program has been constructed so that you can page through the encodements by repeatedly pressing the working width key. The total working width can be encoded after a short press on the key. It is not necessary to encode further if you are not working with boom sections.



If you want to work with boom sections pressing the key again for min. 5 seconds will allow you to encode the boom section width.

### 1. ENCODING THE WORKING WIDTH



Press the keys in this order. XXXX states the actual working width in centimetres. (4 metres = 400 centimetres)

## 2. ENCODING BOOM SECTIONS WIDTHS

Key	Operation
	Press this key.
	Press and hold the key for min. 5 seconds until the following is displayed: 

### QUANTITY CORRECTION

This display states the first value for section encodement. This value is not a section width, but tells the monitor to deduct a value corresponding to the section width from the litre counter when the individual section are switched off.

#### Only 1 or 0 can be encoded.

If 1 is encoded the monitor will reduce the litre counter by an amount corresponding to the width of each section that has been switched off (return to tank after the flowmeter).

If 0 is encoded no reductions will be made when sections are switched off (return to tank before the flowmeter).

#### EXAMPLES:

If you are working with a sprayer fitted with a valve manifold with balanced returns, where the volume through the flowmeter is the same, as long as the return valves are correctly setup, regardless of whether the individual sections are open or closed then **encode 1**. If 1 is not encoded the litre counter will be incorrect, and as the area counter is also reduced, the displayed application rate (L/Ha.) will be incorrect.

If a flowmeter is being used on a sprayer without balanced returns the amount passing through the flowmeter is the same as the amount being sprayed, even when boom sections are closed. If this is the case then **encode 0**. If 0 is not encoded the displayed amounts will be incorrect.

**Boom sections1-9:**

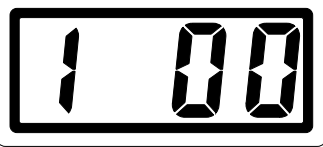
Key	Operation
	Pressing this key displays the following: 

1 is displayed on the left-hand side of the display. This indicates that the width of boom section 1 from the left of the boom can be encoded.

00 is displayed on the right-hand side of the display if the monitor has not been encoded previously, otherwise the last encoded value is displayed. This value is the width of the boom section furthest to the left, the encoded value should correspond to the number of nozzles on this section. This presupposes that the distance between the nozzles is 50 cm.

Once the number of nozzles has been encoded, press the working width key again, and the display changes to boom section 2. Repeat the process again and all of the boom sections can be encoded one by one from the left to the right.

The monitor can work with up to 9 sections. When all of the required boom sections have been encoded, page through the remaining sections ensuring that the unused sections have a value of 0. Boom section encoding cannot be exited by other means.

## FLOWMETER CALIBRATION (FLOW FIGURE)

Key	Function
flwt	<b>FLOW FIGURE</b>

1. If this is the first time that the monitor is being used with a sprayer, encode a “start” flow figure of 2000.
2. It is recommended to hold still when calibrating the flowmeter to avoid incorrect readings on the sprayer tank indicator. If there is any doubt as to the accuracy of the tank indication, then weighing the sprayer will give greater accuracy.
3. Fill the sprayer with min. 600 litres (the more the better) and note the amount filled.
4. Reset the litre counter as follows:

Press:



Press the L key once then press and hold down the 0/C key until the litre counter is zeroed.

5. Spray minimum 500 litres.
6. Read the amount remaining in the tank using the tank indicator.
7. Calculate the consumed amount using the following formula:

**Consumption from tank = Amount filled – Volume remaining in the tank**

8. Insert the consumed amount in the following formula:

$$\text{NEW FLOW FIGURE} = \frac{\text{Old flow figure} \times \text{Consumed litres}}{\text{Amount displayed (litre counter)}}$$

Encode this new value as the new flow figure.

**NOTE!** If the percentile deviation of the flow meter is known, the calibration figure can be altered using the +/-% key. Each time the key is pressed the sign will be altered. The flow figure can only be altered in whole % using this key.

**Procedure:**

If the monitor has counted too many litres, a negative correction must be made. The following example assumes that the monitor has counter 3% too much. The correction is made as follows:

Press



When the keys are pressed in this order, the flow figure will be altered by –3%.

**NOTE!** We recommend calibrating the flow meter several times during a season. This control is always available, as you can check that the monitor has counted the exact contents of the sprayer tank, each time the tank has been emptied. Clean and check the paddle wheel and shaft for wear at regular intervals.

## VOLUME MONITORING CALIBRATION FOR SEED AND FERTILISER

The LH 1200S must be encoded with some special values for volume monitoring on seed drills and fertiliser distributors. The method of measurement is, in principal, the same as for flowmetering on crop sprayers. The calibration value is the volume per pulse from the sensor.

Thus if you let the LH 1200S count the number of pulses during the normal drill/distributor calibration and thereafter divide the amount released (during calibration) by the number of pulses, a new calibration figure for the implement can be found.

**NOTE!** Please note that any changes/adjustments to the drill/distributor require a new calibration.

**Procedure**

1. Prepare the implement for calibration. Do not turn the metering shaft after the monitor has been prepared for calibration.
2. Encode a flow figure of 9999:

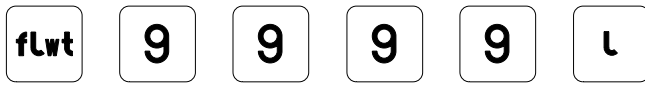

Press the keys in this order and the monitor is ready for counting pulses.

3. Reset the litre counter as follows:

Press



Press the L key then press and hold thereafter the 0/C key until the litre counter is zeroed.

4. Calibrate the implement as described in the manual for the implement and weigh the amount released **precisely**.
5. The calibration figure for the machine can be calculated as follows:

$$\text{NEW CALIBRATION FIGURE (FLOW FIGURE)} = \frac{\text{Amount released in grams} \times 100}{\text{Pulses displayed on the monitor}}$$

Encode the calculated values as the new flow figure.

**NOTE!** The calibration figure can be changed by using the +/-% key if the percentile deviation of the volume monitoring is known. Each time the key is pressed the sign is changed. It is only possible to adjust the calibration figure by whole % values.

**Procedure:**

If the monitor has counted too much, a negative correction must be made.

The following example assumes that the monitor has counted 3% more than the actual amount sown/spread. This can be corrected as follows:

Press



Pressing the keys in the shown order will alter the calibration figure (flow figure) by -3%.



---

## SYSTEM TEST

---

The entire system can be checked according to the following guidelines if you suspect that one of the sensors is not functioning correctly:

**NOTE!** If the tractor is fitted with a junction terminal with changeover switches, remember to select the “correct” sensor when testing.

LH 1200S TEST is selected thus:

Press



Press the keys in the shown order.

The following will be displayed:

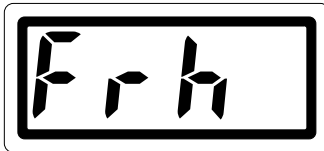

- Pos. 1:** “F” is shown each time a pulse is given from the flowmeter/volume sensor “F” is displayed when the sensor is activated (low), do not run therefore run the machine at full speed. It is best to activate the sensor by turning slowly by hand.
- Pos. 2:** “r” is displayed when the implement sensor is activated.  
**NOTE!** “r” is displayed when the area counter is stopped.
- Pos. 3:** “h” is displayed when the wheel sensor is activated. “h” will be displayed each time the magnet is facing the sensor when you drive slowly forward.

---

## ERROR WARNING

---

To ensure that data will not be lost, the LH 1200S has a built in error indication:

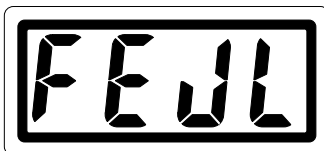

If your LH 1200S displays this error warning, the supply voltage to the monitor is too low. Check therefore the power supply to the monitor (both + and -).

---

## TRAILER PLUG CONNECTIONS

---

### SPRAYER

Sensor	Wire colour	Trailer plug pin no.
Flowmeter	Blue (0V)	5
	Brown (signal)	2
	Black (+12V)	6
Wheel sensor	Blue (signal)	4
	Brown (0V)	5
Implement sensor	Blue (signal)	7
	Brown (0V)	5

### FERTILISER DISTRIBUTOR/SEED DRILL

Sensor	Wire colour	Trailer plug pin no.
Volume sensor	Blue (+12V)	6
	Brown (0V)	5
	Black (signal)	2
Wheel sensor	Blue (signal)	4
	Brown (0V)	5
Implement sensor	Blue (signal)	7
	Brown (0V)	5

---

## TECHNICAL DATA

---

<b>Operation:</b>	Dust proof membrane keypad with 20 keys.
<b>Display:</b>	4-digit, illuminated LCD-display.
<b>Cabinet:</b>	Black anodised aluminium profile.
<b>General data:</b>	Single chip microprocessor. Automatic storage of encoded and registered values. Unlimited memory without battery backup.
<b>Inputs:</b>	Power supply: 12 Volt protected against polarisation. Sensor inputs: 3. internal 10 kOhm pull-up to supply voltage (12V). Pulse level LO < 0.9 V. Pulse level HI > 5.0 V. Fmax. Through noise filter (at 50% duty cycle and 12 V supply voltage). Wheel and implement sensors: 200Hz. Flowmeter/volume sensor: 400Hz.
<b>Working voltage:</b>	10.8 – 16.0 Volt DC. Error warning at 9.7 Volt DC (typical).
<b>Power consumption:</b>	300 mA.
<b>Fuse:</b>	5 x 20 mm 0,63 A.

---

**NOTES**

---