

SHUTOFF/CONTROL MOTORS

Boom Control motors are 22 RPM for 344B series (0.7 second shutoff valves) and 25 RPM for 346B and 356 series (0.6 second shutoff valves) for 12 VDC systems. Available with E or EC series motors with DIN or CABLE versions. E type motors work with DPDT (double pole, double throw) switch. EC type motors work with simple SPST (single pole, single throw) on/off switch and are compatible with all sprayer controls.

Current draw less than 2 AMPS (1.7 AMPS at 40 in-lbs.).

Electrical connectors can be ordered with a standard number. See page 157 for more information.

Note: 2-way control motors can be rotated 180° to change the cable outlet direction on the valve. There is also an adapter to rotate motors 90°, contact your local representative for more information.

REGULATING MOTORS

Choosing the proper regulating motor speed is important to maximizing the sprayer's performance. Three speeds are offered at this time: 1 RPM, 3 RPM and 6 RPM. The 1 RPM speed is used mostly in manual systems; it is too slow for automated rate control. The other two speeds are used in automated systems. The 3 RPM is the most popular and opens the valve to the maximum flow in about 6 seconds for the RL valve and about 10 seconds for the PR valves. The 6 RPM motor cuts those times in half.

DIN AND CABLE ELECTRICAL CONNECTOR

Both DIN and motor cables are made of polyurethane and are pressure extruded creating a round cable for improved sealing. Polyurethane has twice the strength and three times the tear and abrasion resistance of PVC. Motor cables include over-molded plugs that seal off the ends of cables and wires to prevent seepage. Conductor insulation uses familiar color coding of red, white and black.

DIN cable connectors are constructed of a special over molded elastomeric material that does not require a flat gasket to be sealed. The center screw is made of stainless steel.



HOW TO ORDER

38082-30, 10' DIN cable



DIN CABLE	DIN CABLE (FT)
38082-05	1.5
38082-15	5
38082-30	10
38082-60	20

DIN cables are ordered separately.

Positively-Switched BEC Shutoff Motors

Positively-Switched Valves are standard

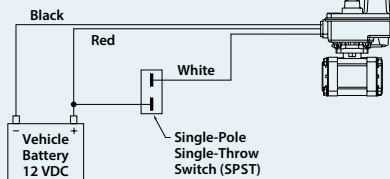

Negatively-Switched BEC Shutoff Motors

Negatively-Switched Valves are special and are notated by an "N" in the Part Number

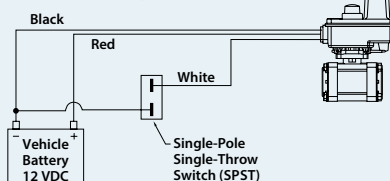

BE Shutoff and BR Regulating Motors

Includes: BE, BR, BRL & BPR Valve Types

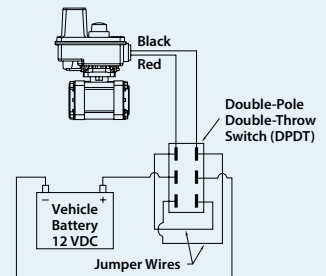

B STYLE SHUTOFF MOTOR NUMBERS

344B, 440B, 450B, 460B SERIES			CURRENT DRAW (AMPS)**	346B, 356 AND 490 SERIES			CURRENT DRAW (AMPS)**		CABLE LENGTH
BEC POSITIVE SWITCH MOTOR	*BEC NEGATIVE SWITCH MOTOR	BE SWITCH MOTOR		344B, 440B, 450B, 460B	BEC POSITIVE SWITCH MOTOR	*BEC NEGATIVE SWITCH MOTOR	BE SWITCH MOTOR	346B	
50515-22P	50515-22N	50533-22	1.1	50515-25P	50515-25N	50533-25	1.75	2.2	No Cable, Metri-Pack Connector
50515-22CP05	50515-22CN05*	50533-22C05	1.1	50515-25CP05	50515-25CN05*	50533-25C05	1.75	2.2	1.5' Cable
50515-22CP15	50515-22CN15*	50533-22C15*	1.1	50515-25CP15	50515-25CN15*	50533-25C15*	1.75	2.2	5' Cable
50515-22CP60	50515-22CN60*	50533-22C60*	1.1	50515-25CP60	50515-25CN60*	50533-25C60*	1.75	2.2	20' Cable
50515-22DP	50515-22DN*	50533-22D*	1.1	50515-25DP	50515-25DN*	50533-25D*	1.75	2.2	DIN Electrical Connector
50515-22QP	50515-22QN*	50533-22Q*	1.1	50515-25QP	50515-25QN*	50533-25Q*	1.75	2.2	Deutsch Electrical Connector

Items marked with "*" are non-stock items. ** Current draw is a nominal rating @ 13.8 VDC and will vary dependent upon valve usage and chemicals used.

Note: DIN cables are ordered separately.

*BYPASS VALVE (NORMALLY OPEN) BEC MOTORS

344B, 440B, 450B, 460B SERIES			CURRENT DRAW (AMPS)**	346B, 356 AND 490 SERIES			CURRENT DRAW (AMPS)**		CABLE LENGTH
BEC POSITIVE SWITCH MOTOR	*BEC NEGATIVE SWITCH MOTOR	BE SWITCH MOTOR		344B, 440B, 450B, 460B	BEC POSITIVE SWITCH MOTOR	*BEC NEGATIVE SWITCH MOTOR	BE SWITCH MOTOR	346B	
50994-22P	50994-22N	50533-22	1.1	50994-25P	50994-25N	50533-25	1.75	2.2	No Cable, Metri-Pack Connector
50994-22CP05	50994-22CN05*	50533-22C05	1.1	50994-25CP05	50994-25CN05*	50533-25C05	1.75	2.2	1.5' Cable
50994-22CP15	50994-22CN15*	50533-22C15*	1.1	50994-25CP15	50994-25CN15*	50533-25C15*	1.75	2.2	5' Cable
50994-22CP60	50994-22CN60*	50533-22C60*	1.1	50994-25CP60	50994-25CN60*	50533-25C60*	1.75	2.2	20' Cable
50994-22DP	50994-22DN*	50533-22D*	1.1	50994-25DP	50994-25DN*	50533-25D*	1.75	2.2	DIN Electrical Connector
50994-22QP	50994-22QN*	50533-22Q*	1.1	50994-25QP	50994-25QN*	50533-25Q*	1.75	2.2	Deutsch Electrical Connector

Items marked with "*" are non-stock items. ** Current draw is a nominal rating @ 13.8 VDC and will vary dependent upon valve usage and chemicals used.

Note: DIN cables are ordered separately.

344B & 346B REGULATING MOTORS

SPEED (RPM)	R & RL MOTOR NO.	PR MOTOR NO.	CURRENT DRAW (AMPS)**		CABLE LENGTH
			AA344B	AA346B	
1	50516-01*	50996-01*	0.10	0.12	No Cable, Metri-Pack Connector
1	50516-01C05*	50996-01C05*	0.10	0.12	1.5' Cable
1	50516-01C15*	50996-01C15*	0.10	0.12	5' Cable
1	50516-01C60*	50996-01C60*	0.10	0.12	20' Cable
1	50516-01D*	50996-01D*	0.10	0.12	DIN Electrical Connector
1	50516-01Q*	50996-01Q*	0.10	0.12	Deutsch Electrical Connector
3	50516-03*	50996-03*	0.15	0.20	No Cable, Metri-Pack Connector
3	50516-03C05*	50996-03C05*	0.15	0.20	1.5' Cable
3	50516-03C15*	50996-03C15*	0.15	0.20	5' Cable
3	50516-03C60*	50996-03C60*	0.15	0.20	20' Cable
3	50516-03D*	50996-03D*	0.15	0.20	DIN Electrical Connector
3	50516-03Q*	50996-03Q*	0.15	0.20	Deutsch Electrical Connector
6	50516-06*	50996-06*	0.43	0.50	No Cable, Metri-Pack Connector
6	50516-06C05*	50996-06C05*	0.43	0.50	1.5' Cable
6	50516-06C15*	50996-06C15*	0.43	0.50	5' Cable
6	50516-06C60*	50996-06C60*	0.43	0.50	20' Cable
6	50516-06D*	50996-06D*	0.43	0.50	DIN Electrical Connector
6	50516-06Q*	50996-06Q*	0.43	0.50	Deutsch Electrical Connector

Items marked with "*" are non-stock items. ** Current draw is a nominal rating @ 13.8 VDC and will vary dependent upon valve usage and chemicals used.

Note: DIN cables are ordered separately. See page 144 for DIN cable options.

DIRECTOVALVE ELECTRIC PRESSURE REGULATING VALVES

The proper regulating valve will enhance the operation of a sprayer, especially one with an automatic rate controller. While advanced electronics provide features and control, the proper regulating valve helps the system to respond quickly to input changes and functions over a wide range of application rates. Choosing the proper valve involves determining the maximum capacity required, the range of application rates and the proper motor speed.

SYSTEM CAPACITY

A regulating valve's system requirements will depend on the application amount and the pumping capacity. Additionally, the regulating valve can be used in bypass or throttling mode. In throttling mode, the flow through the valve will be applied through the nozzles. In bypass mode, the excess flow from the pump is recirculated. A valve that works well throughout the flow spectrum has the best chance to work in all situations.

TYPES OF REGULATING VALVES

Special ball shapes make regulating valves more responsive and able to work with both high and low application rates. Most agricultural sprayers use either a 2-way ball valve or butterfly valve for regulating purposes. When considering sizing a regulating valve, the first concern is to understand the valve's flow curve to determine how efficiently the valve will regulate. Figure 1 shows typical flow curves for DirectoValve® regulating type valves. This will help to decide the type of valve to use.

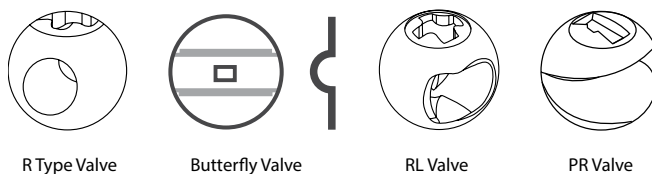

REGULATING VALVE FLOW CURVES

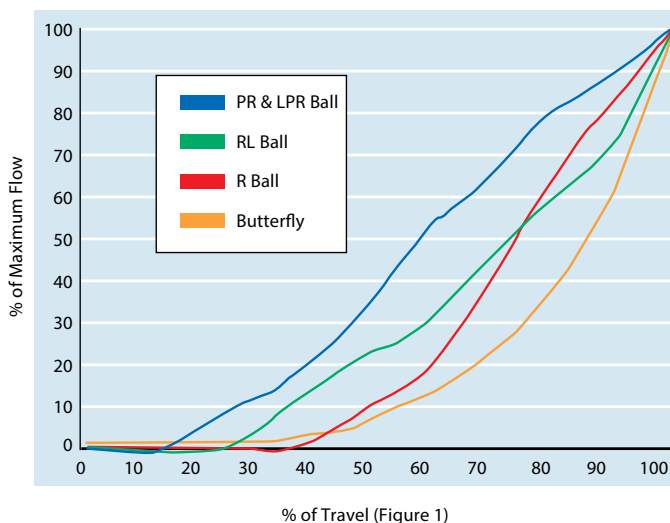

R TYPE & BUTTERFLY VALVES

As shown on the graph, the butterfly valve has the most non-linear flow curve for final 1/3 (30°) of travel leading to an increase of 75% in flow through the valve. The straight 2-way "R" ball curve is not quite as steep, with the flow through the valve increasing by 60% over the last 30° of travel. The "R" ball, however, has the additional disadvantage of not allowing significant flow during the first 1/3 of its rotation. Since a small change of rotation causes a significant change using these valves, trying to regulate large flows when the valve is two thirds to full open presents a challenge.

RL VALVE

TeeJet Technologies has developed a special ball that allows the valve to start regulating earlier thus extending the regulating range. This special ball valve also increases flow and the linear characteristic of the valve during the first 3/4 of the valve cycle. The flow from the valve starts 10° earlier, than a regular R type ball and increases the flow of the RL ball during the first 70% of travel (Figure 1). The maximum capacity is about 10% less than an R type valve.

PR VALVE

The PR valve uses a 3-way valve body and a ball with a wedge removed. The combination of this ball and a motor that rotates past the standard 90° results in a valve with an almost linear flow curve. The BPR version has one outlet plugged. The 3PR version allows bypass flow to return to the tank.

As noted in Figure 1, the percentage of flow increases by approximately the amount of ball travel thus avoiding the rapid change seen with standard ball valves and butterfly valves.

LPR VALVE

The LPR valve is similar to the PR, but with a much smaller wedge removed for very precise regulation in low flow applications.

BALL TYPE REGULATING VALVES

MODEL NUMBER	MAXIMUM PRESSURE	FLOW RATE AT A 5 PSI PRESSURE DROP	FLOW RATE AT A 10 PSI PRESSURE DROP
344BR-2	300 PSI	32 GPM	45 GPM
344BR-3	300 PSI	24 GPM	34 GPM
344BRL-2	300 PSI	27 GPM	38 GPM
344BPR-2*	300 PSI	12 GPM	17 GPM
344BPR-3*	300 PSI	12 GPM	17 GPM
344BLPR-2*	300 PSI	1.5 GPM	2.1 GPM
344BLPR-3*	300 PSI	1.5 GPM	2.1 GPM
346BR-2	150 PSI	100 GPM	141 GPM
346BR-3	150 PSI	64 GPM	91 GPM
346BPR-2*	150 PSI	53 GPM	75 GPM
346BPR-3*	150 PSI	53 GPM	75 GPM

* Not available in stainless steel.



344 BPR Series



346 R Series



346 BPR Series

(B)344BRL-2FS-01C15AB

OUTLET THREADS	
BLANK	All Threads to be NPT (If Equipped)
(B)	All Threads to be BSPT (If Equipped)

MODEL SPECIFICATIONS	
344B/ 346B	Regulating Valve
364B/ 366B	Regulating Valve with Mounting Foot

MOTOR SPECIFICATIONS	
R	Regulating Valve
RL	Linear Regulating Valve (344 Series Only)
PR*	Pressure Regulating Valve
LPR**	Low-Flow PR Valve

*Not available in stainless steel.
**Available only in stainless steel.

VALVE TYPE	
2	2-Way Valve
3	3-Way Valve (LPR, PR & R Only)

END CAPS OR OUTLET FITTINGS	
3	¾" Pipe Thread (344B/364B Only)
4	1" Pipe Thread (344B/364B Only)
5	1¼" Pipe Thread (346B/366B Only)
6	1½" Pipe Thread (346B/366B Only)
Q	Quick Connect (344B/364B Only)
F	50 Series Flange
F75	75 Series Flange (346B/366B Only)
LQ	Large Quick Connect (364B/366B Only)

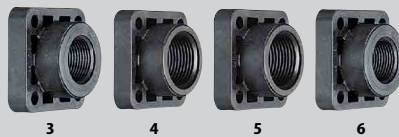

MOTOR SPEEDS	
01	1 RPM (18 Second Cycle Time) Motor
03	3 RPM (6 Second Cycle Time) Motor
06	6 RPM (3 Second Cycle Time) Motor

Note: PR/LPR series cycle times are doubled.

BALL MATERIAL SPECIFICATIONS	
BLANK	Polypropylene Ball
S	Stainless Steel Ball (R, LPR & RL Series Only)

MOTOR CABLES	
BLANK	Metri-Pack Connector
C	0.5-Meter Cable
C03*	0.3-Meter Cable
C15*	1.5-Meter Cable
C60*	6.0-Meter Cable
D	DIN Connector
Q	Positively Switched with Deutsch Connector

Items marked with "*" are non-stock items. Contact your regional sales office for ordering and availability information.

Note: DIN cables must be ordered separately. See page 144 for DIN cables.

INLET/OUTLET REQUIRED CONNECTIONS (THE INLET/OUTLET FITTINGS ARE ORDERED SEPARATELY)	
• 3, 4, 5, 6:	When ordering ¾" (3), 1" (4), 1¼" (5) or 1½" (6) threaded NPT or BSPT inlet/outlet type valve connections, the inlets and outlets will be included during assembly.
• F:	When ordering F or F75 (flange) type valve connections, the inlet/outlet fittings are ordered separately. Clamps and flange fittings are required. See page 158 for flange fitting options.
• Q:	When ordering QC (Quick Connect) hose barb type valve fittings, the inlet/outlet connections are ordered separately. Two 45529 QC fittings are required for 2-way valves and three each for 3-way valves. See page 159 for QC options.
Note: Many valve configurations are possible by mixing and matching flange fittings.	

WIRING CONNECTORS	
Specify electrical connector style and pin-outs. If no connector is needed leave blank. See page 157 for electrical connectors and codes.	

REPAIR KITS	
AB344AE-KIT	AB346B-KIT

Note: AB344AE-KIT for 344A&B Valves

VALVES & MANIFOLDS

DirectoValve® 300 SERIES



344BEC-24-P
2-Way Valve



344BEC-34-P
3-Way Valve



356BEC-D
Valve

REGULATING VALVES	MOTOR SPEED (RPM)	INLET/OUTLET	FLOW RATE (GPM)*		MAX. PRESSURE (PSI)
344B, 2-Way	1, 3, or 6	¾" or 1", 50 Series Flange, QC	32 (R Valve)	27 (RL)	300
			12 (PR)	1.5 (LPR)	
344B, 3-Way	1, 3, or 6	¾" or 1", 50 Series Flange, QC	32 (R Valve)	27 (RL)	300
			12 (PR)	1.5 (LPR)	
346B, 2-Way	1, 3, or 6	1½", or 1¼", 50 Series Flange, 75 Series Flange	100		150
346B, 3-Way	1, 3, or 6	1½", or 1¼", 50 Series Flange, 75 Series Flange	64		150
SHUT OFF VALVES	MOTOR SPEED (RPM)	INLET/OUTLET	FLOW RATE (GPM)*		MAX. PRESSURE (PSI)
344B, 2-Way	22	¾" or 1", QC, 50 Series Flange	32		300
344B, 3-Way	22	¾" or 1", QC, 50 Series Flange	24		300
346B, 2-Way	25	1¼" or 1½", 50 Series Flange, 75 Series Flange	100		150
346B, 3-Way	25	1¼" or 1½", 50 Series Flange, 75 Series Flange	64		150
356B, 2-Way	25	50 Series Flange	100		150

Note: Flow rates are given for a single valve @ 5 PSI pressure drop and will vary based on the number of valves and inlet sizes.



(B)344BEC-2FS-C15AB

OUTLET THREADS	
BLANK	All Threads to be NPT (If Equipped)
(B)	All Threads to be BSPT (If Equipped)

MODEL SPECIFICATIONS	
344B/ 346B	Shutoff Valve
356B	Shutoff Valve with Mounting Foot

MOTOR SPECIFICATIONS		
E	DPDT	22 RPM, 0.7 SEC Cycle (for 344B/364B)
EC	SPST	25 RPM, 0.6 SEC Cycle (for 346B/366B)

VALVE TYPE	
2	2-Way Valve
3	3-Way Valve

END CAPS OR OUTLET FITTINGS	
3	¾" Pipe Thread (344B/364B Only)
4	1" Pipe Thread (344B/364B Only)
5	1¼" Pipe Thread (346B/366B Only)
6	1½" Pipe Thread (346B/366B Only)
Q	Quick Connect (344B/364B Only)
F	50 Series Flange
F75	75 Series Flange (346B/366B Only)
LQ	Large Quick Connect (364B/366B Only)



BALL MATERIAL SPECIFICATIONS	
BLANK	Polypropylene Ball
S	Stainless Steel Ball

MOTOR CABLES	
C	Positively Switched with 0.5-m Cable
C03*	Positively Switched with 0.3-m Cable
C15*	Positively Switched with 1.5-m Cable
C60*	Positively Switched with 6.0-m Cable
D	Positively Switched with DIN Connector
P	Positively Switched with Metri-Pack Connector
Q	Positively Switched with Deutsch Connector

Items marked with "*" are non-stock items. Contact your regional sales office for ordering and availability information. CN (Negatively Switched) motors also available upon request. **Note:** DIN cables must be ordered separately. See page 144 for DIN cables.

INLET/OUTLET REQUIRED CONNECTIONS (THE INLET/OUTLET FITTINGS ARE ORDERED SEPARATELY)	
•	3, 4: When ordering ¾" (3) or 1" (4) threaded NPT or BSPT inlet/outlet type valve connections, the inlets and outlets will be completed during the ordering process.
•	F: When ordering F (flange) type valve connections, the inlet/outlet fittings are ordered separately. Two 50 series clamps and flange fittings are required for 2-way valves and three each for 3-way valves. See page 158 for flange fitting options.
•	Q: When ordering QC (Quick Connect) hose barb type valve fittings, the inlet/outlet connections are ordered separately. Two 45529 QC fittings are required for 2-way valves and three each for 3-way valves. See page 159 for QC options.
Note: Many valve configurations are possible by mixing and matching flange fittings.	

WIRING CONNECTORS	
Specify electrical connector style and pin-outs. If no connector is needed leave blank. See page 157 for electrical connectors and codes.	

REPAIR KITS	
AB344AE-KIT for 344A&B Valves AB346B-KIT for 346B Valves	

VALVES & MANIFOLDS

DirectoValve® 430 SERIES



430 Flow Back
Single Valve



430 2-Way
Single Valve



430 3-Way
Single Valve

SHUT OFF VALVES	INLET	OUTLET	FLOW RATE (GPM)*	MAX. PRESSURE (PSI)
430, Flowback	75 Series Flange, QC	QC	9.2	215
430, 2-Way	QC, 75 Series Flange	QC	11.7	215
430, 3-Way	QC, 75 Series Flange	QC	11.7	215

Note: Flow rates are given for a single valve @ 5 PSI pressure drop and will vary based on the number of valves and inlet sizes.



VALVES & MANIFOLDS



437EC-3FBF75-D

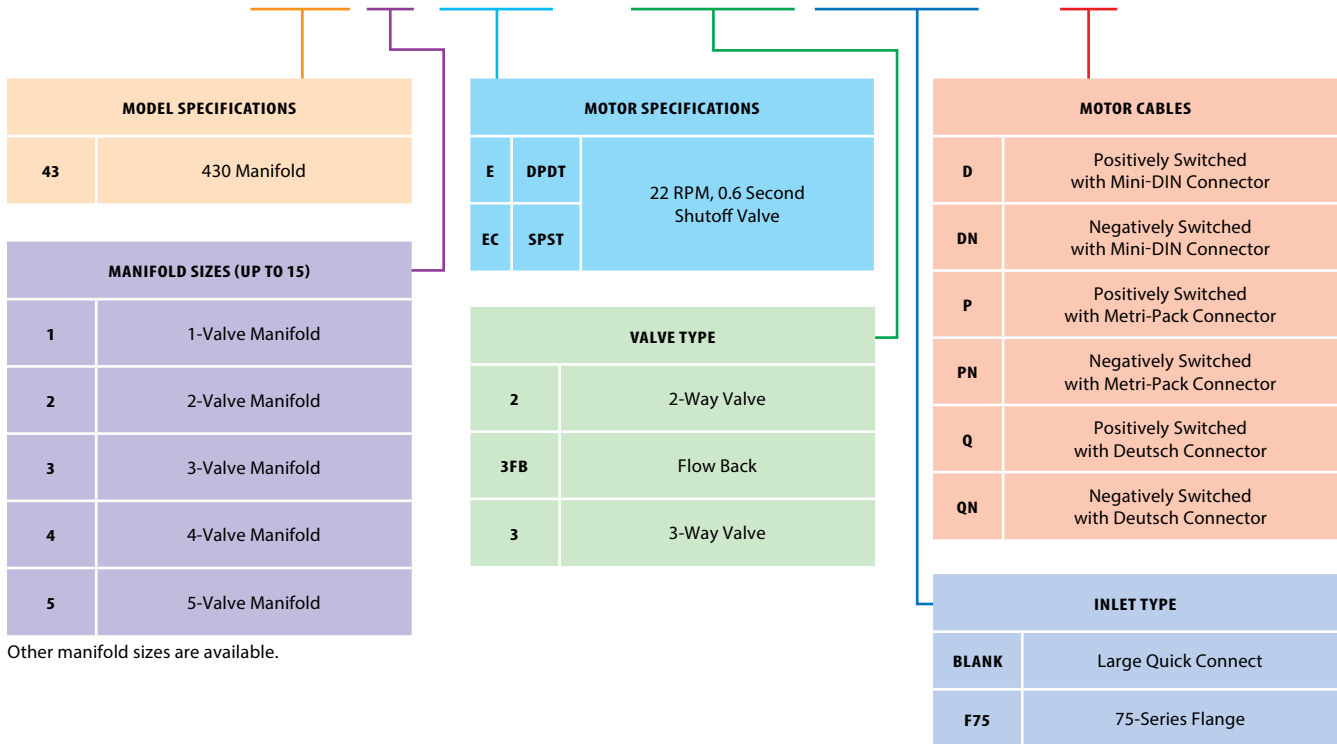

SAMPLE MINI-DIN CABLE ASSEMBLY PART CODE

58480EC-15-VX

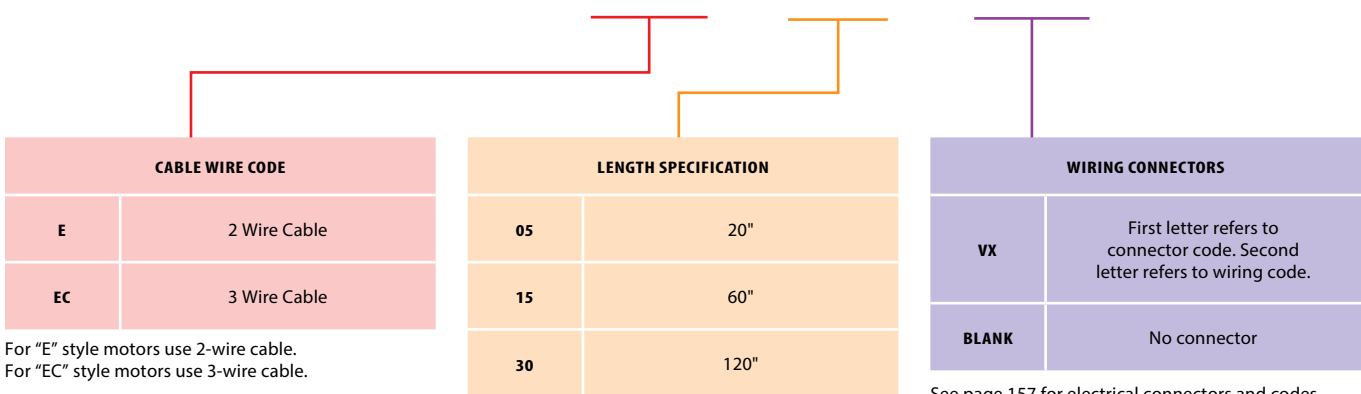

See page 157 for electrical connectors and codes.

DirectoValve® 400 SERIES



451BEC-2F-P
Valve



453BEC-3FBF-P
Manifold



453BEC-2F-P
Manifold

SHUT OFF VALVES	INLET	OUTLET	FLOW RATE (GPM)*	MAX. PRESSURE (PSI)
440B, 2-Way	¼" or 1" NPT, 1" or 1¼" Hose Barb	¾" or 1", 50 Series Flange, QC	26	300
450B, 2-Way	75 Series Flange	¾" or 1", 50 Series Flange, QC	32	200
450B, Flowback	75 Series Flange	¾" or 1", 50 Series Flange, QC	32	200
460B, 2-Way	50 Series Flange	¾" or 1", 50 Series Flange, QC	25	300
460B, 3-Way	50 Series Flange	¾" or 1", 50 Series Flange, QC	25	300
460B, Flowback	50 Series Flange	¾" or 1", 50 Series Flange, QC	24	115
490B	75 Series Flange	50 Series Flange	100	150

Note: Flow rates are given for a single valve @ 5 PSI pressure drop and will vary based on the number of valves and inlet sizes.



VALVES & MANIFOLDS



(B)453BEC-3FBFS-C15AB

OUTLET THREADS	
BLANK	All Threads to be NPT (If Equipped)
(B)	All Threads to be BSPT (If Equipped)

MODEL SPECIFICATIONS	
45	450 Manifold

MANIFOLD SIZES	
1	1-Valve Manifold
2	2-Valve Manifold
3	3-Valve Manifold
4	4-Valve Manifold
5	5-Valve Manifold

VALVE TYPE	
3FB	Flow Back
2	2-Way Valve
2N	2-Way Valve, Narrow

END CAPS OR OUTLET FITTINGS	
3	¾" Pipe Thread
4	1" Pipe Thread
Q	Quick Connect
F	50 Series Flange



MOTOR SPECIFICATIONS	
E	DPDT
EC	SPST
22 RPM, 0.7 Second Shutoff Valve	

BALL MATERIAL SPECIFICATIONS	
BLANK	Polypropylene Ball
S	Stainless Steel Ball

MOTOR CABLES	
C	Positively Switched with 0.5-m Cable
C03*	Positively Switched with 0.3-m Cable
C15*	Positively Switched with 1.5-m Cable
C60*	Positively Switched with 6.0-m Cable
D	Positively Switched with DIN Connector
P	Positively Switched with Metri-Pack Connector

WIRING CONNECTORS	
Specify electrical connector style and pin-outs. If no connector is needed leave blank. See page 157 for electrical connectors and codes.	

REPAIR KITS	
AB344AE-KIT	

Items marked with "*" are non-stock items. Contact your regional sales office for ordering and availability information. CN (Negatively Switched) motors also available upon request. **Note:** DIN cables must be ordered separately. See page 144 for DIN cables.

INLET/OUTLET REQUIRED CONNECTIONS (THE INLET/OUTLET FITTINGS ARE ORDERED SEPARATELY)

- 3, 4:** When ordering ¾" (3) or 1" (4) NPT or BSPT threaded connections, the valve outlet connection will be completed during the ordering process.
 - For the inlets, two 75 Series flange fittings and two 75 Series clamps are required. For the Flow Back ports, two 45529 Quick Connect fittings are required.*
- F:** For the flange fitting versions, one 50 Series single clamp and 50 Series flange fitting is required per valve outlet.
 - For the inlets, two 75 Series flange fittings and two 75 Series clamps are required. For the Flow Back ports, two 45529 Quick Connect fittings are required.*
- Q:** For Quick Connect versions, one 45529 QC hose barb fitting is required per valve outlet.
 - For the inlets, two 75 series flange fittings and two 75 Series clamps are required. For the Flow Back ports, two 45529 Quick Connect fittings are required.*

*See pages 158–159 for flange and Quick Connect fitting options.
Note: Many manifold configurations are possible by mixing and matching flange fittings.

VALVES & MANIFOLDS

DirectoValve® 500 SERIES



530AM-2
Manual Valve



530AEC-FB
Electric Valve



530AEC-3
Electric Valve



540 EC
Electric Valve

MANUAL SHUT OFF VALVES	INLET	OUTLET	FLOW RATE (GPM)*	MAX. PRESSURE (PSI)
530AM, 2-Way	LQC, QC, 50 Series Flange, 75 Series Flange	QC	10	300
530AM, 3-Way	LQC, QC, 50 Series Flange, 75 Series Flange	QC	10	300
ELECTRIC SHUT OFF VALVES	INLET	OUTLET	FLOW RATE (GPM)*	MAX. PRESSURE (PSI)
530AEC, 2-Way	LQC, QC, 50 Series Flange, 75 Series Flange	QC	10	300
530AEC, 3-Way	LQC, QC, 50 Series Flange, 75 Series Flange	QC	10	300
530AEC, Flow Back	LQC, QC, 50 Series Flange, 75 Series Flange	QC	10	300
540EC	75 Series Flange	QC	27	175

Note: Flow rates are given for a single valve @ 5 PSI pressure drop and will vary based on the number of valves and inlet sizes.



533AEC-2F50-PN

MANIFOLD SIZES (UP TO 15)	
1	1-Valve Manifold
2	2-Valve Manifold
3	3-Valve Manifold
4	4-Valve Manifold
5	5-Valve Manifold

MOTOR SPECIFICATIONS		
AE	DPDT	Electric Shut-Off Valve
AEC	SPST	Electric Shut-Off Valve
AM	MANUAL	Manual Shut-Off Valve

VALVE TYPE	
2	2-Way Valve
3	3-Way Valve
FB	Flow Back (Electric Only)

INLET FITTINGS	
BLANK	Large Quick Connect
F50	50 Series Flange
F75	75 Series Flange
Q	Quick Connect



MOTOR CABLES	
D	Positively Switched with Mini-DIN Connector
DN	Negatively Switched with Mini-DIN Connector
P	Positively Switched, with Metri-Pack Connector, No Cable
PN	Negatively Switched, with Metri-Pack Connector, No Cable
Q	Positively Switched with Deutsch Connector
QN	Negatively Switched with Deutsch Connector

REPAIR KITS	
AB530AM-2-KIT	
AB530A-2-KIT	
AB530A-3-KIT	
AB530A-FB-KIT	

INLET/OUTLET REQUIRED CONNECTIONS (THE INLET/OUTLET FITTINGS ARE ORDERED SEPARATELY)

- F:** For inlets, two 75 Series clamps and flange fittings or two 50 Series clamps and flange fittings are required. See page 158 for flange fitting options.
- LQ:** For large quick connect inlets, two 58456 fittings are required. See page 159 for LQ fitting options.
- Q:** For Quick Connect inlet and outlet, one 45529 QC hose barb is required per connection. See page 159 for Quick Connect fitting options.

SAMPLE METRI-PACK CABLE ASSEMBLY PART CODE

98546EC-15-VX

CABLE WIRE CODE	
E	2 Wire Cable
EC	3 Wire Cable

LENGTH SPECIFICATION	
05	20"
15	60"
30	120"

WIRING CONNECTORS	
Specify electrical connector style and pin-outs. If no connector is needed leave blank.	
See Page 157 for electrical connectors and codes.	

For "E" style motors use 2-wire cable.
For "EC" style motors use 3-wire cable.

CONTROL UNITS

- Pressure relief valve (98510-PP).
- 344BRL electric regulating valve, bypass mode for 98600-C-433E(C) and 98601-B-433E(C) models.
- Liquid strainer (AA126ML-M50-80-VI) for 98600-C-433E(C) and 98601-B-433E(C) models.
- Flowmeter (801A) for 98600-C-433E(C) models.



MODEL NUMBER	VALVE SECTIONS	VALVE TYPE	PRESSURE (PSI)	FLOW PER SECTION
98600-C-433E(C)-2	3	2-Way	215	11.7 GPM (5 PSI Pressure Drop)
98601-C-435E(C)-3FB	5	Flow Back	215	9.2 GPM (5 PSI Pressure Drop)
98602-C-434E(C)-3	4	3-Way	215	11.7 GPM (5 PSI Pressure Drop)
98600-B-433E(C)-2	3	2-Way	215	11.7 GPM (5 PSI Pressure Drop)
98601-B-434E(C)-3FB	4	Flow Back	215	9.2 GPM (5 PSI Pressure Drop)
98602-B-435E(C)-3	5	3-Way	215	11.7 GPM (5 PSI Pressure Drop)
98600-A-437E(C)-2	7	2-Way	215	11.7 GPM (5 PSI Pressure Drop)
98601-A-435E(C)-3FB	5	Flow Back	215	9.2 GPM (5 PSI Pressure Drop)
98602-A-433E(C)-3	3	3-Way	215	11.7 GPM (5 PSI Pressure Drop)

Note: Valves can be ordered in 1–9 sections configuration. For inlet and outlet connections refer to page 159.

430/530 MANIFOLD ACCESSORIES

MODEL NUMBER	DESCRIPTION
344BRL-B	Bypass Regulating Valve
344BRL-TH	Throttling Regulating Valve
346BEC-2M	2-Way 3-Valve Shutoff Manifold
98510-NYB	Pressure Relief Valve
118560	Compact Pressure Relief Valve
118570	Compact Throttling Valve
AA126ML-M50	Line Strainer
AA122ML-QC	Outlet Strainer
801A	Flowmeter
AB98499-KIT	4-Bolt Flange Accessory Mounting Kit
CP98498-SS	Mounting Bracket



Note: TeeJet Technologies recommends the use of sealed connectors to improve reliability and prolong component life.

CHART 1: CONNECTOR CODES



2-PIN OR 3-PIN	<p>AMP MALE FASTON CONNECTOR</p> <p>Note: No pin-out code needed with these connectors.</p>  <p>2-Pin = Code A 3-Pin = Code J</p>	<p>AMP FEMALE FASTON CONNECTOR</p> <p>Note: No pin-out code needed with these connectors.</p>  <p>2-Pin = Code B 3-Pin = Code K</p>	
	<p>AMP FEMALE MATE-N-LOK® CONNECTOR (SEALED)</p>  <p>2-Pin = Code C 3-Pin = Code L</p>	<p>AMP MALE MATE-N-LOK® CONNECTOR (SEALED)</p>  <p>2-Pin = Code D 3-Pin = Code M</p>	
	<p>WEATHER PACK SHROUD CONNECTOR (SEALED)</p>  <p>2-Pin = Code E 3-Pin = Code O</p>	<p>WEATHER PACK TOWER CONNECTOR (SEALED)</p>  <p>2-Pin = Code F 3-Pin = Code P</p>	
	<p>DEUTSCH DT FEMALE CONNECTOR (SEALED)</p>  <p>2-Pin = Code G 3-Pin = Code Q</p>	<p>DEUTSCH DT MALE CONNECTOR (SEALED)</p>  <p>2-Pin = Code H 3-Pin = Code R</p>	
	<p>METRIPACK FEMALE CONNECTOR (SEALED)</p>  <p>3-Pin = Code S</p>	<p>JST VH FEMALE CONNECTOR (SEALED)</p>  <p>2-Pin = Code I 3-Pin = Code T</p>	
	4-PIN	<p>WEATHER PACK SHROUD CONNECTOR (SEALED)</p>  <p>4-Pin = Code U</p>	<p>WEATHER PACK TOWER CONNECTOR (SEALED)</p> <p>Note: "VX" connector style is used to connect valves to many TeeJet controller harnesses.</p>  <p>4-Pin = Code V</p>
		<p>DEUTSCH DT FEMALE CONNECTOR (SEALED)</p>  <p>4-Pin = Code W</p>	

CHART 2: PIN-OUT CODES

CODE LETTER	CONNECTOR POSITION				CODE LETTER	CONNECTOR POSITION			
	A OR 1	B OR 2	C OR 3	D OR 4		A OR 1	B OR 2	C OR 3	D OR 4
A	R	W	P	B	M	P	R	W	B
B	R	W	B	P	N	P	R	B	W
C	R	B	W	P	O	P	W	R	B
D	R	B	P	W	P	P	W	B	R
E	R	P	W	B	Q	P	B	R	W
F	R	P	B	W	R	P	B	W	R
G	W	R	B	P	S	B	R	W	P
H	W	R	P	B	T	B	R	P	W
I	W	P	R	B	U	B	W	R	P
J	W	P	B	R	V	B	W	P	R
K	W	B	R	P	W	B	P	R	W
L	W	B	P	R	X	B	P	W	R

For regulating and E-style, 2-wire cables, the white position will be plugged.

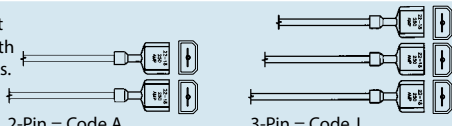
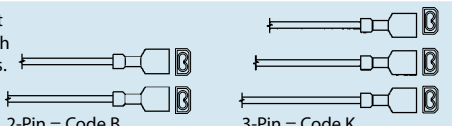
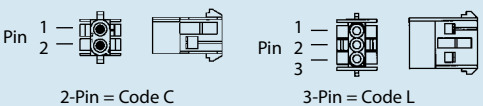
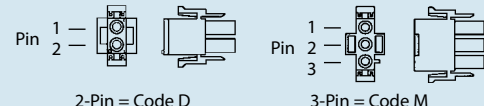
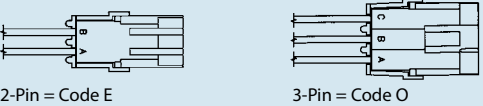
HOW TO ORDER

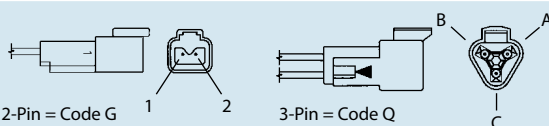
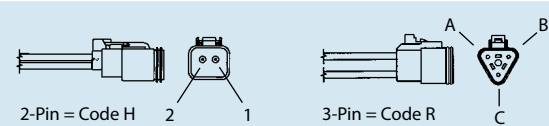
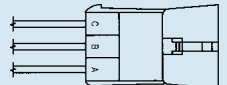
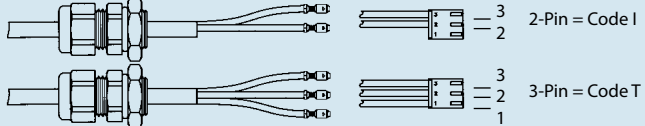
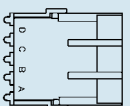
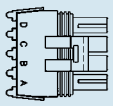
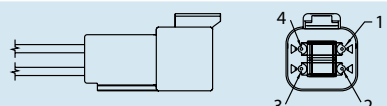
This system is to be used for ball valves and ball valve manifolds equipped with electrical connectors. Connector and pin-outs are to be specified in valve or manifold part number when ordering. **Note:** On 2-pin connectors, only pin-out code C or S is used.

First: Specify code for connector desired (See Chart 1).

Second: Specify appropriate wire pin-out arrangement (See Chart 2).

3 5 6 B E C - C L B

Pin-out Code
Connector Code

Wire Codes

R = Red (+12V) W = White (Switched)
P = Plugged B = Black (Ground)



50 SERIES FLANGED FITTINGS

- Maximum pressure rating of 300 PSI.
- Polypropylene construction.

PART NUMBER	DESCRIPTION
CP48150-PP	3/4" Hose Barb
CP45504-PP	1" Hose Barb
CP45505-PP	1 1/4" Hose Barb
CP45506-PP	1 1/2" Hose Barb
CP48151-PP	90° x 3/4" Hose Barb
CP48152-PP	90° x 1" Hose Barb
CP72238-PP	90° x 1 1/4" Hose Barb
CP72239-PP	90° x 1 1/2" Hose Barb
CP(B)48172-PP	3/4" Male Pipe Thread
CP(B)48155-PP	1" Male Pipe Thread
CP(B)48156-PP	1 1/2" Male Pipe Thread
CP(B)48159-PP	3/4" Female Pipe Thread
CP(B)48154-PP	1" Female Pipe Thread
CP(B)45512-PP	1 1/4" Female Pipe Thread
CP(B, P)45508-1/4-PP	1/4" Gauge Port
CP(B, P)45539-3/8-PP	3/8" Gauge Port
CP45507-PP	Blank Inlet Cover
CP48157-PP	Straight Coupling
CP48158-PP	90° Elbow Coupling
CP46029-PP	Male Quick Connect Adapter
CP50193-PP*	Tee
CP55242-PP*	Narrow Tee
46070**	2-Way 460 Valve Clamp, Nylon
46024**	3-Way 460 Valve Clamp, Nylon
55245-50**	50 Series Flange Clamp, Stainless Steel
CP7717-2/222-VI	50 Series Clamps O-Ring, FKM
CP98491-PP	Bolted Flange Adapter

*There are no mounting provisions on the 50 Series tee. (B)=BSPT (P)=BSPP
 **O-ring included.

75 SERIES FLANGED FITTINGS

- Maximum pressure rating of 200 PSI.
- Polypropylene construction.

PART NUMBER	DESCRIPTION
CP48160-PP	1 1/4" Hose Barb
CP46067-PP	1 1/2" Hose Barb
CP48161-PP	2" Hose Barb
CP48162-PP	90° x 1 1/4" Hose Barb
CP48163-PP	90° x 1 1/2" Hose Barb
CP48164-PP	90° x 2" Hose Barb
CP(B)48165-PP	1 1/4" Male Pipe Thread
CP(B)48166-PP	1 1/2" Male Pipe Thread
CP(B)48167-PP	2" Male Pipe Thread
CP(B)46066-PP	1 1/2" Female Pipe Thread
CP(B)46127-1/4-PP	1/4" Gauge Port
CP(B)46127-3/8-PP	3/8" Gauge Port
CP46069-PP	Blank Inlet Cover
CP48169-PP	Straight Coupling
CP45207-PP	75 x 50 Series Reducer Coupling
CP48168-PP	90° Elbow Coupling
CP46717-PP	75 x 50 Series Reducer Tee
CP46716-PP	Tee
CP45251-PP	450 Tee Body
CP55224-PP	450 Tee Body (Narrow)
55245-75**	75 Series Flange Clamp, Stainless Steel
CP7717-2-229-VI	75 Series Clamps O-Ring, FKM
CP98490-PP	F75 Bolted Flange Adapter

**O-ring included. (B)=BSPT (P)=BSPP

48143 MOUNTING KIT

Mounts to underside of tee and includes one extrusion and four screws. Mounting kit is not included with tees. Must be ordered separately. Also requires 5/16" or 8 mm bolt.

PART NUMBER	DESCRIPTION
48143	Tee Mounting Kit (450 or 490 Series Manifold)



45529-1/2



45529-C



45529-PTC-4-3/8



45529-90-1



CP46029-PP



CP45527-NYB



CP45527-NYB



45529-P



58456-1-1/4



58456-1000



58456-90-1000



58456-C



116240-LM



58456-P



58456-1250M

QUICK CONNECT FITTINGS

- Use on valves and components equipped with Quick Connect outlets.
- Rated to 300 PSI.

PART NUMBER	DESCRIPTION
45529-C	Quick Connect Cap (F)
45529-P	Quick Connect Plug (M)
45529-3/8*	3/8" Straight Hose Barb (F)
45529-1/2*	1/2" Straight Hose Barb (F)
45529-5/8*	5/8" Straight Hose Barb (F)
45529-3/4*	3/4" Straight Hose Barb (F)
45529-1*	1" Straight Hose Barb (F)
45529-90-1/2*	1/2" 90° Hose Barb (F)
45529-90-5/8*	5/8" 90° Hose Barb
45529-90-3/4*	3/4" 90° Hose Barb (F)
45529-90-1*	1" 90° Hose Barb (F)
45529-90-1-1/4*	1 1/4" 90° Hose Barb
45529-3/4M	3/4" Hose Barb (M)*
45529-1M	1" Hose Barb (M)*
CP46029-PP	50 Series Flange (M)
CP45527-NYB	3/4" Male Pipe Thread
CP45526-NYB	1" Male Pipe Thread
45529-QT	Quick TeeJet Straight Fitting
45529-PTC-4-3/8	4 x 3/8" PTC Quick Connect Fitting
CP37166-1-302SS	Retaining Clip 302SS
CP7717-3-912-VI	O-Ring (FKM)
CP116237-NYB	QC Bolted Flange Adapter

*Includes Retaining Clip and O-Ring.

LARGE QUICK CONNECT FITTINGS

- Used for 430 and 530 manifold inlets and select ball valves.
- Rated to 215 PSI.

PART NUMBER	DESCRIPTION
58456-C	Cap Fitting
58456-P	Plug Fitting
(B)58456-1/4	1/4" Female Thread (Gauge Port)
(B)58456-3/4	3/4" Female Thread (Gauge Port)
(B)58456-1	1" Female Thread (Gauge Port)
(B)58456-1-1/4	1 1/4" Female Thread (Gauge Port)
(B)58456-1-1/2	1 1/2" Female Thread (Gauge Port)
58456-1000	1" Straight Hose Barb
58456-1250	1 1/4" Straight Hose Barb
58456-1500	1 1/2" Straight Hose Barb
58456-2000	2" Straight Hose Barb
58456-90-1000	1" 90° Hose Barb
58456-90-1250	1 1/4" 90° Hose Barb
58456-90-1500	1 1/2" 90° Hose Barb
58456-90-2000	2" 90° Hose Barb
58456-1250M	1 1/4" Hose Barb
58456-1500M	1 1/2" Hose Barb
116240-LM*	Tee
CP37166-1-302SS	Retaining Clip 302SS
CP7717-M40X4-VI	O-Ring (FKM)
CP98497-PP	LQC Bolted Flange Adapter

Note: Retaining Clip and O-Ring included.

(B)=BSPT

*Includes 3 O-Rings and 3 Retaining Clips.

AA144P-, AA144A- & AA145H- DIRECTOVALVE CONTROL VALVES

- Direct acting; large internal flow chamber without pilot hole reduces chance of clogging.
- Stainless steel wetted parts provide additional corrosion resistance.
- Operate on 12 VDC system.
- Maximum pressure of 100 PSI.
- Encapsulated solenoid coil can be changed without removing valve from system.
- EPDM diaphragms and seat washers, FKM optional.
- Continuous flow through bypass connection, with flow to spray line controlled by valve "on-off" action.

AA144P DIRECTOVALVE CONTROL VALVES

- Flow Rate: 10 GPM at 5 PSI pressure drop, 14 GPM at 10 PSI pressure drop.
- 2.5 AMP current draw.
- Polypropylene body for chemical resistance.
- Fabric reinforced FKM diaphragms and seat washers.
- No stroke adjustment required.
- Corrosion resistant, 430SS solenoid grade armature and armature stop.
- Encapsulated coil and magnetic circuit.

MODEL NUMBER	INLET SIZE	OUTLET SIZE	CURRENT DRAW
AA(B)144P-*	¾"	½"	2.5 AMP

(B) = BSPT



AA144A VALVE FOR PRESSURES UP TO 100 PSI

- Flow Rate: 10 GPM at 5 PSI pressure drop, 14 GPM at 10 PSI pressure drop.
- Can be ganged with other 144A DirectoValve control valves.
- 2.5 AMP current draw.
- Polypropylene body for chemical resistance.
- Fabric reinforced diaphragms.
- Also available as 2- or 3-unit assembly.

MODEL NUMBER	INLET SIZE	OUTLET SIZE	CURRENT DRAW
AA(B)144A-*	¾"	½"	2.5 AMP

(B) = BSPT

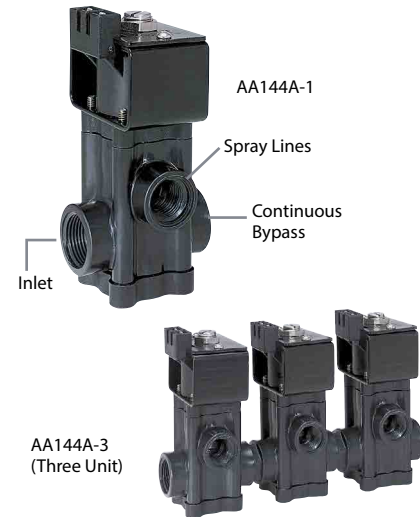

AA145H CONTROL VALVES

- Flow Rate: 15 GPM at 5 PSI pressure drop, 21 GPM at 10 PSI pressure drop.
- Can be ganged with other 145H DirectoValve control valves.
- 2.9 AMP current draw.
- Fiberglass reinforced Nylon body.

MODEL NUMBER	INLET SIZE	OUTLET SIZE	CURRENT DRAW
AA145H-1	1"	1"	2.9 AMP





AA144P-1-3 DIRECTOVALVE CONTROL VALVES

The 144P-1-3 three-way solenoid-operated DirectoValve control valve was specifically designed to provide bypass control in spraying applications. When used with part number 23520-PP throttling valve or a 4916 metering orifice plate in the bypass line, it can provide for a constant pressure spray system.

- For pressure to 65 PSI .
- Flow Rate: 8 GPM at 5 PSI pressure drop, 11 GPM at 10 PSI pressure drop.
- Fabric-reinforced FKM diaphragms.
- Nylon encapsulated 12 VDC coil with ¼" Quick Connect terminals.
- Power requirement 2.5 AMP.
- Glass-filled polypropylene (black) valve body.
- Internal metal parts are stainless steel.
- No stroke adjustment needed.
- Corrosion resistant, 430SS solenoid grade armature and armature stop.



AA144A-1-3 DIRECTOVALVE CONTROL VALVES

The three-way solenoid-operated DirectoValve control valve bypasses boom flow to maintain constant spraying pressure when one or more boom sections are shut off. To maintain pressure with a 23520 Throttling Valve, Outlet 2 must be throttled to match the total capacity of the nozzles on that boom section.

- For pressures to 65 PSI.
- Flow Rate: 8 GPM at 5 PSI pressure drop, 11 GPM at 10 PSI pressure drop.
- 2.5 AMP current draw.
- Encapsulated 12 VDC coil can be easily changed without removing valve from line.
- Polypropylene body for chemical resistance.
- Stainless steel internal metal parts.
- Chemical resistant EPDM diaphragms and seat washers.



MODEL NUMBER	NUMBER OF UNITS IN ASSEMBLY	SPRAY LINE CONNECTION	CONTINUOUS FLOW INLET BYPASS CONNECTION
AA(B)144P-1-3	1	½"	¾"
AA(B)144P-2-3	2	½"	¾"
AA(B)144P-3-3	3	½"	¾"
AA(B)144A-1-3	1	½"	¾"
AA(B)144A-2-3	2	½"	¾"
AA(B)144A-3-3	3	½"	¾"

(B) = BSPT

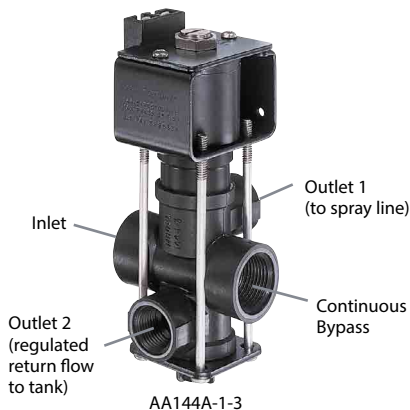



AA(B)344M-NYB

344M-NYB 2-WAY NYLON MANUAL BALL VALVES

- Quarter turn of handle from shutoff to full flow.
- $\frac{3}{4}$ " or 1" NPT and BSPT (F) connection.
- Wetted parts: Nylon, PTFE, polypropylene, and FKM.

AA(B)344M-NYB

VALVE NUMBER	MAXIMUM PRESSURE (PSI)	NUMBER OF OUTLETS	CONNECTION SIZE
AA(B)344M-2-3/4	300	1	$\frac{3}{4}$ "
AA(B)344M-2-1		1	1"

Flow Rate: 5 PSI pressure drop for 32 GPM flow.

(B) = BSPT



AA(B)343M-PP

340M-PP SERIES 2-WAY MANUAL BALL VALVES

- Quarter turn of handle from shutoff to full flow.
- $\frac{3}{8}$ ", $\frac{1}{2}$ ", $\frac{3}{4}$ ", 1", $1\frac{1}{4}$ " or $1\frac{1}{2}$ " NPT and BSPT (F) connection.
- Wetted parts: glass-reinforced polypropylene, PTFE, and FKM.

AA(B)343M-PP

VALVE NUMBER	MAXIMUM PRESSURE (PSI)	NUMBER OF OUTLETS	CONNECTION SIZE
AA(B)343M-2-3/8-PP	150	1	$\frac{3}{8}$ "
AA(B)343M-2-1/2-PP		1	$\frac{1}{2}$ "

Flow Rate: 5 PSI pressure drop for 11 GPM flow.

(B) = BSPT



AA(B)344M-PP

AA(B)344M-PP

VALVE NUMBER	MAXIMUM PRESSURE (PSI)	NUMBER OF OUTLETS	CONNECTION SIZE
AA(B)344M-2-3/4-PP	125	1	$\frac{3}{4}$ "
AA(B)344M-2-1-PP		1	1"

Flow Rate: 5 PSI pressure drop for 32 GPM flow.

(B) = BSPT



AA(B)346M-PP

AA(B)346M-PP

VALVE NUMBER	MAXIMUM PRESSURE (PSI)	NUMBER OF OUTLETS	CONNECTION SIZE
AA(B)346M-2-1-1/4-PP	125	1	$1\frac{1}{4}$ "
AA(B)346M-2-1-1/2-PP		1	$1\frac{1}{2}$ "

Flow Rate: 5 PSI pressure drop for 100 GPM flow.

(B) = BSPT



AA(B)344M-NYB

344M-NYB 3-WAY NYLON MANUAL BALL VALVES

- 3-way version diverts flow to either outlet; no shutoff.
- 3/4" or 1" NPT and BSPT (F) connection.
- Wetted parts: Nylon, PTFE, polypropylene, and FKM.

AA(B)344M-NYB

VALVE NUMBER	MAXIMUM PRESSURE (PSI)	NUMBER OF OUTLETS	CONNECTION SIZE
AA(B)344M-3-3/4	300	2	3/4"
AA(B)344M-3-1		2	1"

Flow Rate: 5 PSI pressure drop for 24 GPM flow.

(B) = BSPT



AA(B)343M-PP

340M-PP SERIES 3-WAY MANUAL BALL VALVES

- 3-way version diverts flow to either outlet; no shutoff.
- 3/8", 1/2", 3/4", 1", 1 1/4" or 1 1/2" NPT and BSPT (F) connection.
- Wetted parts: glass-reinforced polypropylene, PTFE, and FKM.

AA(B)343M-PP

VALVE NUMBER	MAXIMUM PRESSURE (PSI)	NUMBER OF OUTLETS	CONNECTION SIZE
AA(B)343M-3-3/8-PP	150	2	3/8"
AA(B)343M-3-1/2-PP		2	1/2"

Flow Rate: 5 PSI pressure drop for 8 GPM flow.

(B) = BSPT



AA(B)344M-PP

AA(B)344M-PP

VALVE NUMBER	MAXIMUM PRESSURE (PSI)	NUMBER OF OUTLETS	CONNECTION SIZE
AA(B)344M-3-3/4-PP	125	2	3/4"
AA(B)344M-3-1-PP		2	1"

Flow Rate: 5 PSI pressure drop for 24 GPM flow.

(B) = BSPT



AA(B)346M-PP

AA(B)346M-PP

VALVE NUMBER	MAXIMUM PRESSURE (PSI)	NUMBER OF OUTLETS	CONNECTION SIZE
AA(B)346M-3-1-1/4-PP	125	2	1 1/4"
AA(B)346M-3-1-1/2-PP		2	1 1/2"

Flow Rate: 5 PSI pressure drop for 64 GPM flow.

(B) = BSPT

PISTON-TYPE PRESSURE RELIEF/REGULATING VALVES

Bypasses excess liquid. Adjustable to maintain control of line pressure at any pressure within the valve's operating range. Selected pressure setting firmly held in place by locknut. Extra-large valve passages to handle large flows.



23120



6815



110-1/4 &
110-3/8



110-1, 110-1-1/4
& 110-1-1/2



8460

23120

- 302 stainless steel spring and EPDM O-ring.
- Excellent chemical resistance.
- 1/4" port for pressure gauge pipe plug included.

VALVE NUMBER	INLET & PIPE CONNECTIONS	MATERIAL	PRESSURE RANGE (PSI)
(B)23120-*-PP	1/2" or 3/4"	Polypropylene	150
(B)23120A-*-PP	1/2" or 3/4"	Polypropylene	150
(B)23120-*-PP-60	1/2" or 3/4"	Polypropylene	60
(B)23120-*-PP-60-VI	1/2" or 3/4"	Polypropylene	60

*Specify pipe size.

(B) = BSPT

6815

- Other models for high pressures up to 1,200 PSI are also available.
- Also available with hardened stainless steel seat.

VALVE NUMBER	INLET & PIPE CONNECTIONS	MATERIAL	PRESSURE RANGE (PSI)
(B)6815-*-50	1/2" or 3/4"	Brass	50
(B)6815-*-300	1/2" or 3/4"	Brass	300
(B)6815-*-700	1/2" or 3/4"	Brass	700

*Specify pipe size.

(B) = BSPT

110

- Removable bonnet for servicing unit without removing valve from line.

VALVE NUMBER	INLET & PIPE CONNECTIONS	MATERIAL	PRESSURE RANGE (PSI)
AA(B)110-*-50	1/4" or 3/8"	Brass	50
AA(B)110-*-150	1/4" or 3/8"	Brass	150
AA(B)110-*-300	1/4" or 3/8"	Brass	300
AA(B)110-*-700	1/4" or 3/8"	Brass	700
AA(B)110-1	1"	Brass, Aluminum or Ductile Iron	150
AA(B)110-1-1/4	1 1/4"	Brass, Aluminum or Ductile Iron	150
AA(B)110-1-1/2	1 1/2"	Brass, Aluminum or Ductile Iron	150

*Specify pipe size.

(B) = BSPT

8460 DIAPHRAGM-TYPE PRESSURE RELIEF/ REGULATING VALVES

- Flow rate to 56 GPM for 1/2" and 70 GPM for 3/4".
- 8460-*-50 uses stainless steel springs while 8460-*-300 uses steel springs—responsive to the pressure range of each valve.
- Extra-large valve passages to handle full flow from supply line.
- Positive locknut to hold adjustment screw firmly in place. Not affected by jarring and vibration.

VALVE NUMBER	INLET & PIPE CONNECTIONS	MATERIAL		PRESSURE RANGE (PSI)
		INLET BODY	BONNET	
8460-*-50	1/2" or 3/4"	Nylon	Aluminum	50
8460-*-300	1/2" or 3/4"	Nylon	Aluminum	300

*Specify pipe size.

(B) = BSPT

DirectoValve® MANUAL CONTROL VALVE

AA6B

- Molded of corrosion resistant materials; all wetted parts are polypropylene, stainless steel and polyethylene.
- Maximum pressure of 150 PSI.
- Flow Rate: 12 GPM at 5 PSI pressure drop, 17 GPM at 10 PSI pressure drop.
- Molded-in mounting flange and ¼" NPT gauge port.
- Valves can be ganged together using hex nipple for multiple boom control.
- Easily repaired without removing valve from spray line.

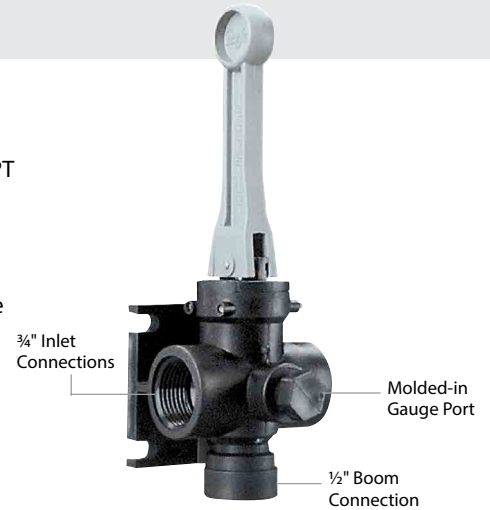

TeeValve® CONTROL VALVES

AA17

For selective control of three-section boom sprayers at pressures up to 300 PSI.

- Use to open any of three boom section lines in any desired combination.
- Raise lever to open, lower lever to close the valve without changing the indexed position.
- Aluminum construction with stainless steel and plastic internal parts for maximum corrosion resistance.

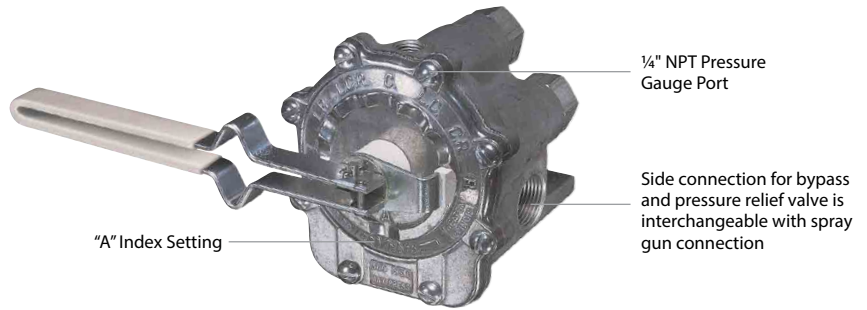

VALVE NUMBER	MATERIAL	MAXIMUM PRESSURE	INLET	(3) BOOM OUTLETS	ACCESSORY OUTLET
AA17Y	Aluminum, Polymer, SS	300 PSI	1" NPT	¾" (F)	¾" (F)
AA17L	Aluminum, Polymer, SS	300 PSI	¾" NPT	¾" (F)	¾" (F)

TeeJet® THROTTLING VALVES

23520, 12690 & 12795

For regulating flow in systems equipped with centrifugal pumps where sensitive regulation is required or to control flow in jet agitator return lines. Locknut holds pressure setting firmly in place.



23520



12795



12690

VALVE NUMBER	INLET & PIPE CONNECTIONS	MATERIAL	PRESSURE RANGE
23520	½" and ¾" NPT or BSPT	Polypropylene	150 PSI
12690	½" or ¾" NPT	Nylon, Acetal, Aluminum, Steel, Stainless Steel	125 PSI
12795	1", 1¼" or 1½" NPT	Brass, Aluminum, Ductile Iron	150 PSI

*Specify pipe size.

(B) = BSPT